

Features

- 3.0V to 5.5V Operating Range
- Advanced, High-speed, Electrically-erasable Programmable Logic Device
 - Superset of 22V10
 - Enhanced Logic Flexibility
 - Architecturally Compatible with ATV750B and ATV750 Software and Hardware
- D- or T-type Flip-flop
- Product Term or Direct Input Pin Clocking
- 10 ns Maximum Pin-to-pin Delay with 5V Operation
- 15 ns Maximum Pin-to-pin Delay with 3V Operation
- Highest Density Programmable Logic Available in 24-pin Package
 - Advanced Electrically-erasable Technology
 - Reprogrammable
 - 100% Tested
- Increased Logic Flexibility
 - 42 Array Inputs, 20 Sum Terms and 20 Flip-flops
- Enhanced Output Logic Flexibility
 - All 20 Flip-flops Feed Back Internally
 - 10 Flip-flops are also Available as Outputs
- Programmable Pin-keeper Circuits
- Dual-in-line and Surface Mount Package in Standard Pinouts
- Commercial and Industrial Temperature Ranges
- 20-year Data Retention
- 2000V ESD Protection
- 1000 Erase/Write Cycles
- Green Package Options (Pb/Halide-free/RoHS Compliant) Available

1. Block Diagram



2. Description

The Atmel® “750” architecture is twice as powerful as most other 24-pin programmable logic devices. Increased product terms, sum terms, flip-flops and output logic configurations translate into more usable gates. High-speed logic and uniform, predictable delays guarantee fast in-system performance. The ATF750LVC is a high-performance CMOS (electrically-erasable) complex programmable logic device (CPLD) that utilizes Atmel’s proven electrically-erasable technology.



**High-speed
Complex
Programmable
Logic Device**

ATF750LVC



3. Pin Configurations

Pin Name	Function
CLK	Clock
IN	Logic Inputs
I/O	Bi-directional Buffers
GND	Ground
VCC	3V to 5.5V Supply

3.1 PLCC

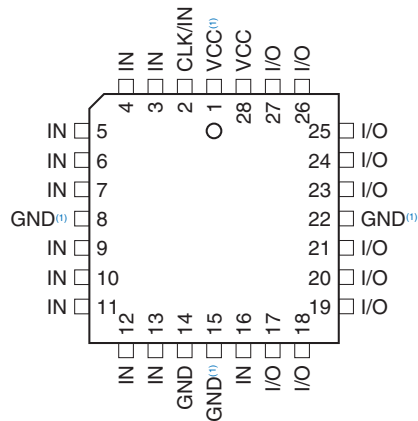

3.2 DIP/SOIC/TSSOP

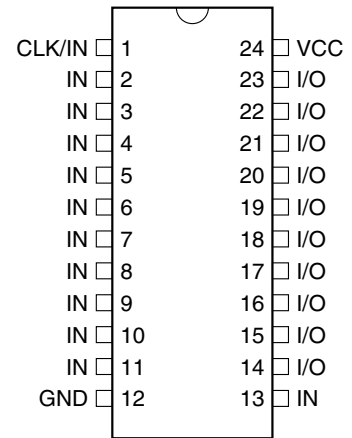

Note: 1. For PLCC, pins 1, 8, 15, and 22 can be left unconnected. For superior performance, connect VCC to pin 1 and GND to pins 8, 15, and 22.

Each of the ATF750LVC's 22 logic pins can be used as an input. Ten of these can be used as inputs, outputs or bi-directional I/O pins. Each flip-flop is individually configurable as either D- or T-type. Each flip-flop output is fed back into the array independently. This allows burying of all the sum terms and flip-flops.

There are 171 total product terms available. There are two sum terms per output, providing added flexibility. A variable format is used to assign between four to eight product terms per sum term. Much more logic can be replaced by this device than by any other 24-pin PLD. With 20 sum terms and flip-flops, complex state machines are easily implemented with logic to spare.

Product terms provide individual clocks and asynchronous resets for each flip-flop. Each flip-flop may also be individually configured to have direct input pin controlled clocking. Each output has its own enable product term. One product term provides a common synchronous preset for all flip-flops. Register preload functions are provided to simplify testing. All registers automatically reset upon power-up.

4. Absolute Maximum Ratings*

Temperature Under Bias.....	-40°C to +85°C
Storage Temperature	-65°C to +150°C
Voltage on Any Pin with Respect to Ground	-2.0V to +7V ⁽¹⁾
Voltage on Input Pins with Respect to Ground During Programming.....	-2.0V to +14.0V ⁽¹⁾
Programming Voltage with Respect to Ground	-2.0V to +14.0V ⁽¹⁾

***NOTICE:** Stresses beyond those listed under “Absolute Maximum Ratings” may cause permanent damage to the device. This is a stress rating only and functional operation of the device at these or any other conditions beyond those indicated in the operational sections of this specification is not implied. Exposure to absolute maximum rating conditions for extended periods may affect device reliability.

Note: 1. Minimum voltage is -0.6V DC, which may undershoot to -2.0V for pulses of less than 20 ns. Maximum output pin voltage is $V_{CC} + 0.75V$ DC, which may overshoot to 7V for pulses of less than 20 ns with V_{CC} at V_{CC} max.

5. DC and AC Operating Conditions

	Commercial	Industrial
Operating Temperature (Ambient)	0°C - 70°C	-40°C - +85°C
V_{CC} Power Supply	3.0 - 5.25V	3.0 - 5.5V

6. Clock Mux

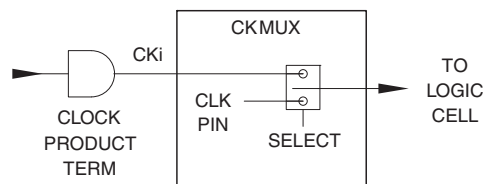

7. Output Options

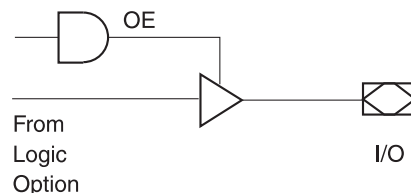
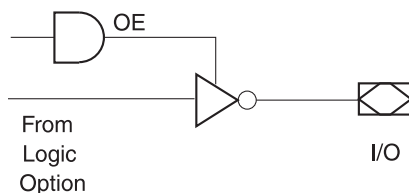

8. Bus-friendly Pin-keeper Input and I/Os

All input and I/O pins on the ATF750LVC have programmable “pin-keeper” circuits. If activated, when any pin is driven high or low and then subsequently left floating, it will stay at that previous high or low level.

This circuitry prevents unused input and I/O lines from floating to intermediate voltage levels, which cause unnecessary power consumption and system noise. The keeper circuits eliminate the need for external pull-up resistors and eliminate their DC power consumption.

Enabling or disabling of the pin-keeper circuits is controlled by the device type chosen in the logic compiler device selection menu. Please refer to the software compiler table for more details. Once the pin-keeper circuits are disabled, normal termination procedures are required for unused inputs and I/Os.

Table 1. Software Compiler Mode Selection

Synario	WinCupl	Pin-keeper Circuit
ATF750LVC	V750C	Disabled
ATF750LVC (PPK)	V750CPPK	Enabled

9. Input Diagram



10. I/O Diagram

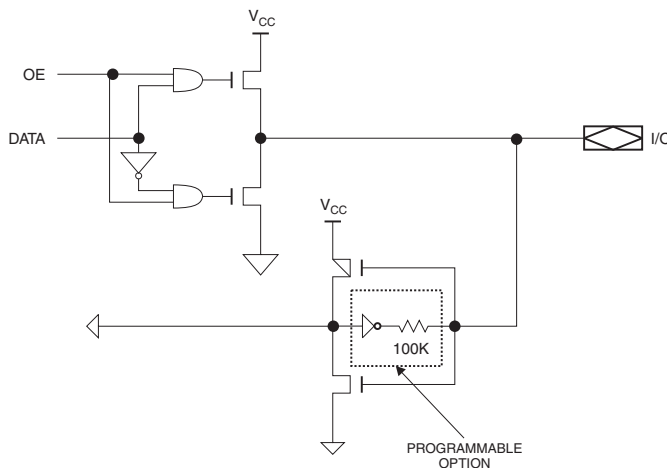

11. DC Characteristics

Symbol	Parameter	Condition		Min	Typ	Max	Units	
V_{CC}	Power Supply Voltage	3V Operation		3.0	3.3	3.6	V	
		5V Operation	Com.	4.75	5.0	5.25	V	
			Ind.	4.5	5.0	5.5	V	
I_{LI}	Input Load Current	$V_{IN} = -0.1V$ to $V_{CC} + 1V$				10	μA	
I_{LO}	Output Leakage Current	$V_{OUT} = -0.1V$ to $V_{CC} + 0.1V$				10	μA	
I_{CC}	Power Supply Current, Standby	$V_{CC} = 3.6V$ $V_{IN} = 3.6V$ Outputs Open	C-15	Com.		65	90	mA
				Ind.		70	100	mA
I_{CC}	Power Supply Current, Standby	$V_{CC} = 5.25V$ $V_{IN} = 5.25V$ Outputs Open	C-15	Com.		100	180	mA
				Ind.		110	190	mA
$I_{OS}^{(1)(2)}$	Output Short Circuit Current	$V_{OUT} = 0.5V$				-120	mA	
V_{IL}	Input Low Voltage	$Min \leq V_{CC} \leq Max$		-0.6		0.8	V	
V_{IH}	Input High Voltage			2.0		$V_{CC} + 0.75$	V	
V_{OL}	Output Low Voltage	$V_{IN} = V_{IH}$ or V_{IL} , $V_{CC} = Min$		$I_{OL} = 16$ mA	Com., Ind.		0.5	V
				$I_{OL} = 12$ mA	Mil.		0.5	V
				$I_{OL} = 24$ mA	Com.		0.8	V
V_{OH}	Output High Voltage	$V_{IN} = V_{IH}$ or V_{IL} , $V_{CC} = Min$		$I_{OH} = -100$ μA		$V_{CC} - 0.3V$		V
				$I_{OH} = -2.0$ mA		2.4		V

- Notes: 1. Not more than one output at a time should be shorted. Duration of short circuit test should not exceed 30 sec.
2. This test is performed at initial characterisation only.

12. Input Test Waveforms and Measurement Levels

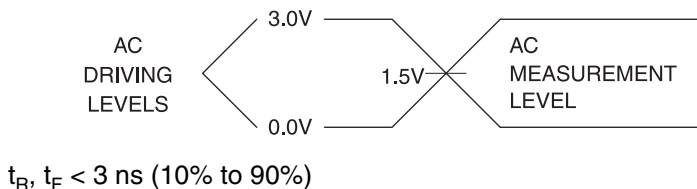

13. Output Test Load

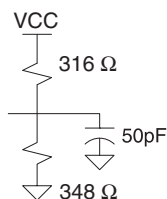

14. AC Waveforms, Product Term Clock⁽¹⁾



Note: 1. Timing measurement reference is 1.5V. Input AC driving levels are 0.0V and 3.0V, unless otherwise specified.

15. AC Characteristics, Product Term Clock⁽¹⁾

Symbol	Parameter	-15 (5V Operation)		-15 (3V Operation)		Units
		Min	Max	Min	Max	
t_{PD}	Input or Feedback to Non-registered Output		10		15	ns
t_{EA}	Input to Output Enable		10		15	ns
t_{ER}	Input to Output Disable		10		15	ns
t_{CO}	Clock to Output	4	10	5	12	ns
t_{CF}	Clock to Feedback	4	7.5	5	9	ns
t_S	Input Setup Time	4		8		ns
t_{SF}	Feedback Setup Time	4		7		ns
t_H	Hold Time	2		5		ns
t_P	Clock Period	11		14		ns
t_W	Clock Width	5.5		7		ns
f_{MAX}	External Feedback $1/(t_S + t_{CO})$		71		50	MHz
	Internal Feedback $1/(t_{SF} + t_{CF})$		86		62	MHz
	No Feedback $1/(t_P)$		90		71	MHz
t_{AW}	Asynchronous Reset Width	10		15		ns
t_{AR}	Asynchronous Reset Recovery Time	10		15		ns
t_{AP}	Asynchronous Reset to Registered Output Reset		12		15	ns
t_{SP}	Setup Time, Synchronous Preset	7		8		ns

Note: 1. See ordering information for valid part numbers.

16. AC Waveforms, Input Pin Clock⁽¹⁾

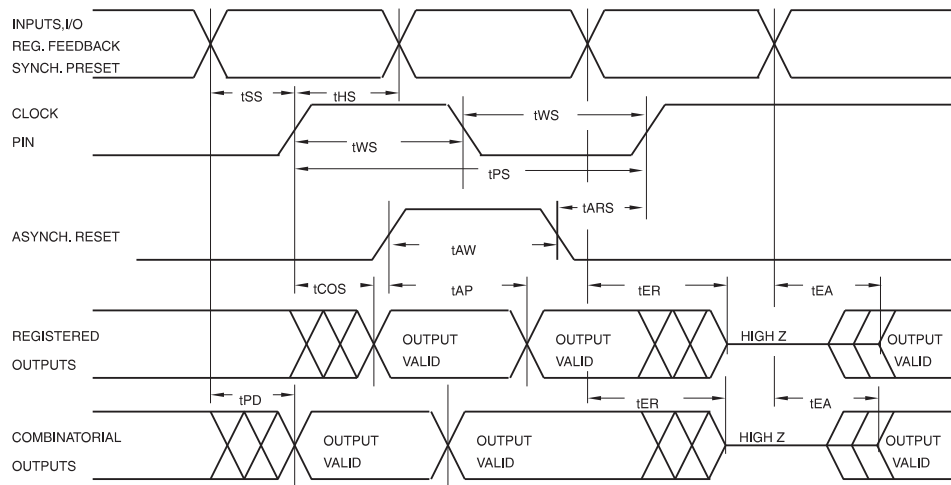

Note: 1. Timing measurement reference is 1.5V. Input AC driving levels are 0.0V and 3.0V, unless otherwise specified.

17. AC Characteristics, Input Pin Clock

Symbol	Parameter	-15 (5V Operation)		-15 (3V Operation)		Units
		Min	Max	Min	Max	
t_{PD}	Input or Feedback to Non-registered Output		10		15	ns
t_{EA}	Input to Output Enable		10		15	ns
t_{ER}	Input to Output Disable		10		15	ns
t_{COS}	Clock to Output	0	7	0	10	ns
t_{CFS}	Clock to Feedback	0	5	0	5.5	ns
t_{SS}	Input Setup Time	5		8		ns
t_{SFS}	Feedback Setup Time	5		7		ns
t_{HS}	Hold Time	0		5		ns
t_{PS}	Clock Period	10		14		ns
t_{WS}	Clock Width	5		7		ns
f_{MAXS}	External Feedback $1/t_{SS} + t_{COS}$		83		55	MHz
	Internal Feedback $1/t_{SFS} + t_{CFS}$		100		80	MHz
	No Feedback $1/t_{PS}$		100		83	MHz
t_{AW}	Asynchronous Reset Width	10		15		ns
t_{ARS}	Asynchronous Reset Recovery Time	10		15		ns
t_{AP}	Asynchronous Reset to Registered Output Reset		10		15	ns
t_{SPS}	Setup Time, Synchronous Preset	5		11		ns

18. Functional Logic Diagram ATF750LVC, Upper Half

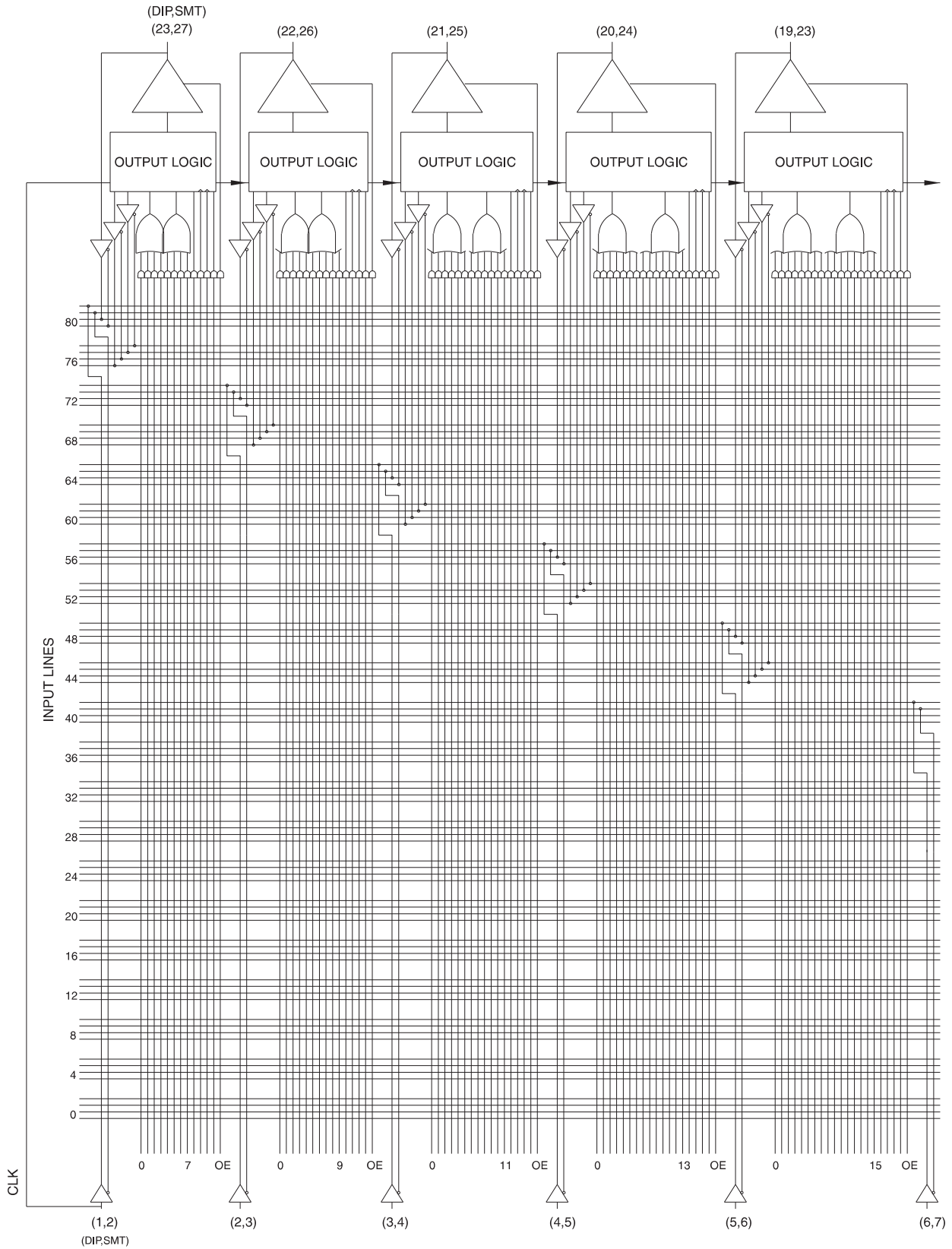

19. Functional Logic Diagram ATF750LVC, Lower Half

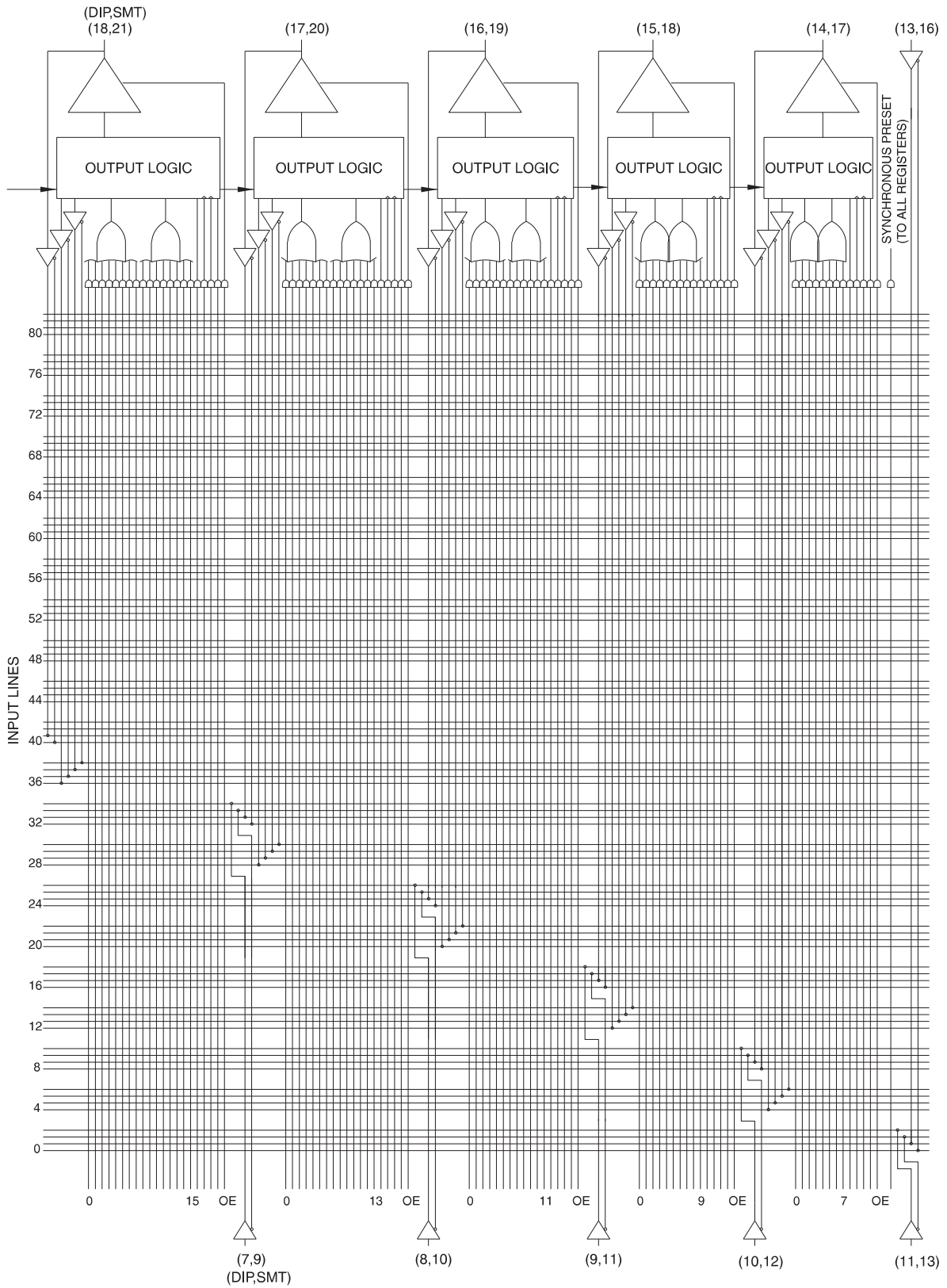

20. Using the ATF750LVC's Many Advanced Features

The ATF750LVC's advanced flexibility packs more usable gates into 24-pins than any other logic device. The ATF750LVCs start with the popular 22V10 architecture, and add several enhanced features:

- **Selectable D- and T-type Registers**

Each ATF750LVC flip-flop can be individually configured as either D- or T-type. Using the T-type configuration, JK and SR flip-flops are also easily created. These options allow more efficient product term usage.

- **Selectable Asynchronous Clocks**

Each of the ATF750LVC's flip-flops may be clocked by its own clock product term or directly from Pin 1 (SMD Lead 2). This removes the constraint that all registers must use the same clock. Buried state machines, counters and registers can all coexist in one device while running on separate clocks. Individual flip-flop clock source selection further allows mixing higher performance pin clocking and flexible product term clocking within one design.

- **A Full Bank of Ten More Registers**

The ATF750LVC provides two flip-flops per output logic cell for a total of 20. Each register has its own sum term, its own reset term and its own clock term.

- **Independent I/O Pin and Feedback Paths**

Each I/O pin on the ATF750LVC has a dedicated input path. Each of the 20 registers has its own feedback terms into the array as well. This feature, combined with individual product terms for each I/O's output enable, facilitates true bi-directional I/O design.

21. Synchronous Preset and Asynchronous Reset

One synchronous preset line is provided for all 20 registers in the ATF750LVC. The appropriate input signals to cause the internal clocks to go to a high state must be received during a synchronous preset. Appropriate setup and hold times must be met, as shown in the switching waveform diagram.

An individual asynchronous reset line is provided for each of the 20 flip-flops. Both master and slave halves of the flip-flops are reset when the input signals received force the internal resets high.

22. Security Fuse Usage

A single fuse is provided to prevent unauthorized copying of the ATF750LVC fuse patterns. Once the security fuse is programmed, all fuses will appear programmed during verify.

The security fuse should be programmed last, as its effect is immediate.

ATF750LVC OUTPUT SOURCE CURRENT VS. SUPPLY VOLTAGE ($V_{OH} = 2.4V$)

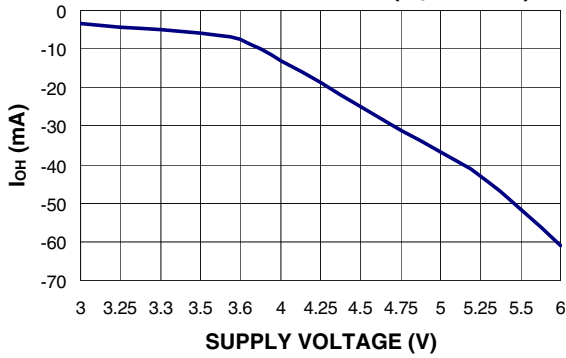

ATF750LVC OUTPUT SINK CURRENT VS. SUPPLY VOLTAGE ($V_{OL} = 0.5V$)

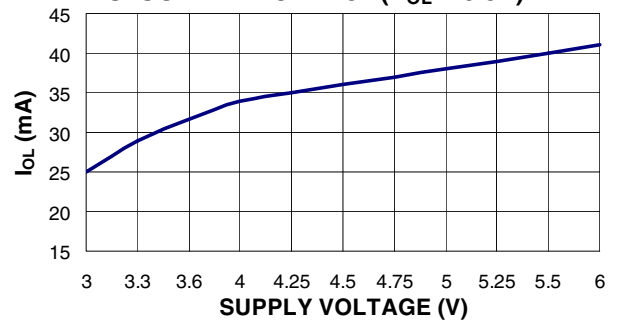

ATF750LVC INPUT CURRENT VS. INPUT VOLTAGE ($T_A = 25^\circ C$) WITH PIN KEEPER

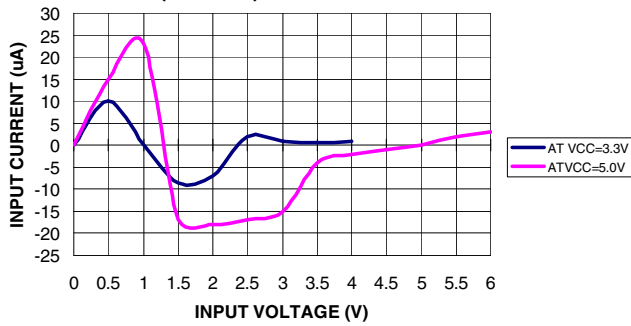

ATF750LVC INPUT CLAMP CURRENT VS. INPUT VOLTAGE ($T_A = 25^\circ C$)

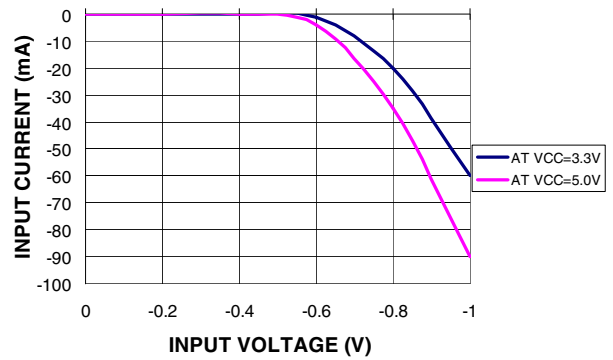

ATF750LVC SUPPLY CURRENT VS. SUPPLY VOLTAGE ($T_A = 25^\circ C$)

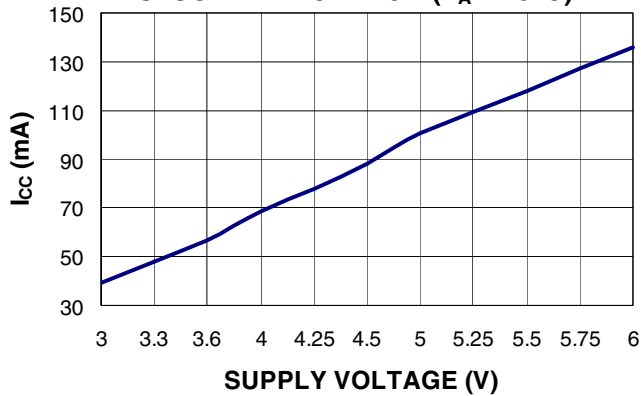

ATF750LVC OUTPUT SOURCE CURRENT VS. OUTPUT VOLTAGE ($T_A = 25^\circ\text{C}$)

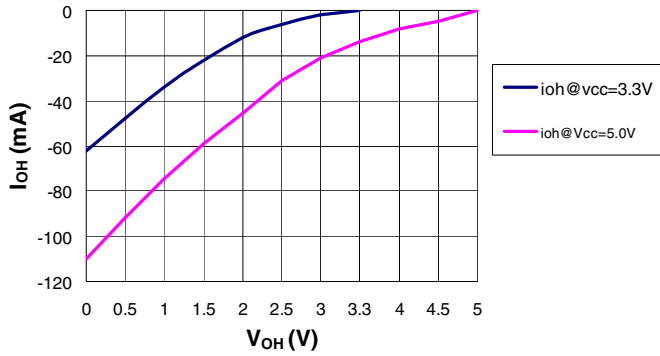

ATF750LVC OUTPUT SINK CURRENT VS. OUTPUT VOLTAGE ($T_A = 25^\circ\text{C}$)

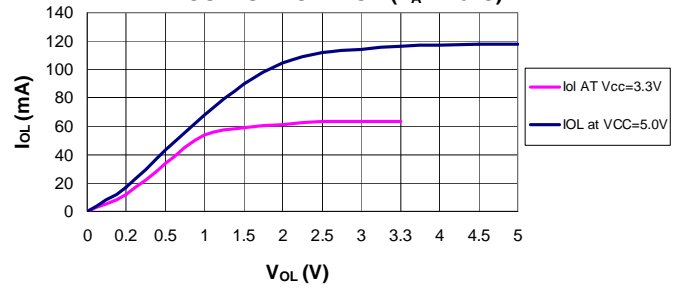

ATF750LVC SUPPLY CURRENT VS. INPUT FREQUENCY ($T_A = 25^\circ\text{C}$)

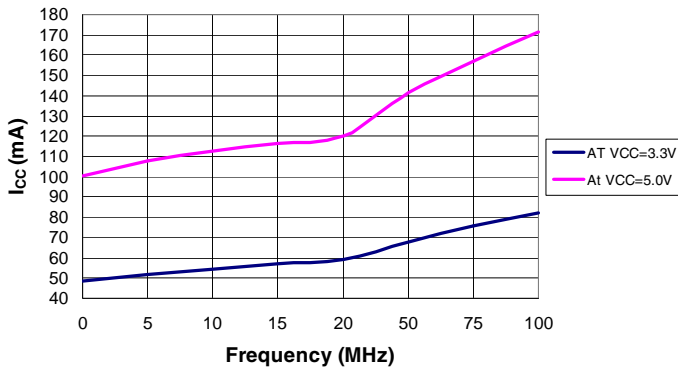

NORMALIZED SUPPLY CURRENT OVER TEMPERATURE (AT $V_{CC} = 3.3\text{V}$ & 5.0V)

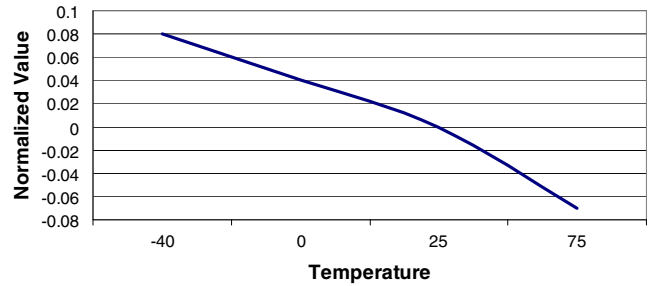

23. ATF750LVC Ordering Information

23.1 ATF750LVC Green Package Options (Pb/Halide-free/RoHS Compliant)

t_{PD} (ns)	t_{COS} (ns)	Ext. f_{MAXS} (MHz)	Ordering Code	Package	Operation Range
15	10	55	ATF750LVC-15JU ATF750LVC-15PU ATF750LVC-15SU ATF750LVC-15XU ⁽¹⁾	28J 24P3 24S 24X	Industrial (-40°C to 85°C)

Note: 1. Special order only; TSSOP package requires special thermal management.

Package Type	
28J	28-Lead, Plastic J-leaded Chip Carrier (PLCC)
24P3	24-lead, 0.300" Wide, Plastic Dual Inline Package (PDIP)
24S	24-lead, 0.300" Wide, Plastic Gull Wing Small Outline (SOIC)
24X*	24-lead, 0.173" Wide, Thin Shrink Small Outline (TSSOP)

24. Package Information

24.1 28J – PLCC

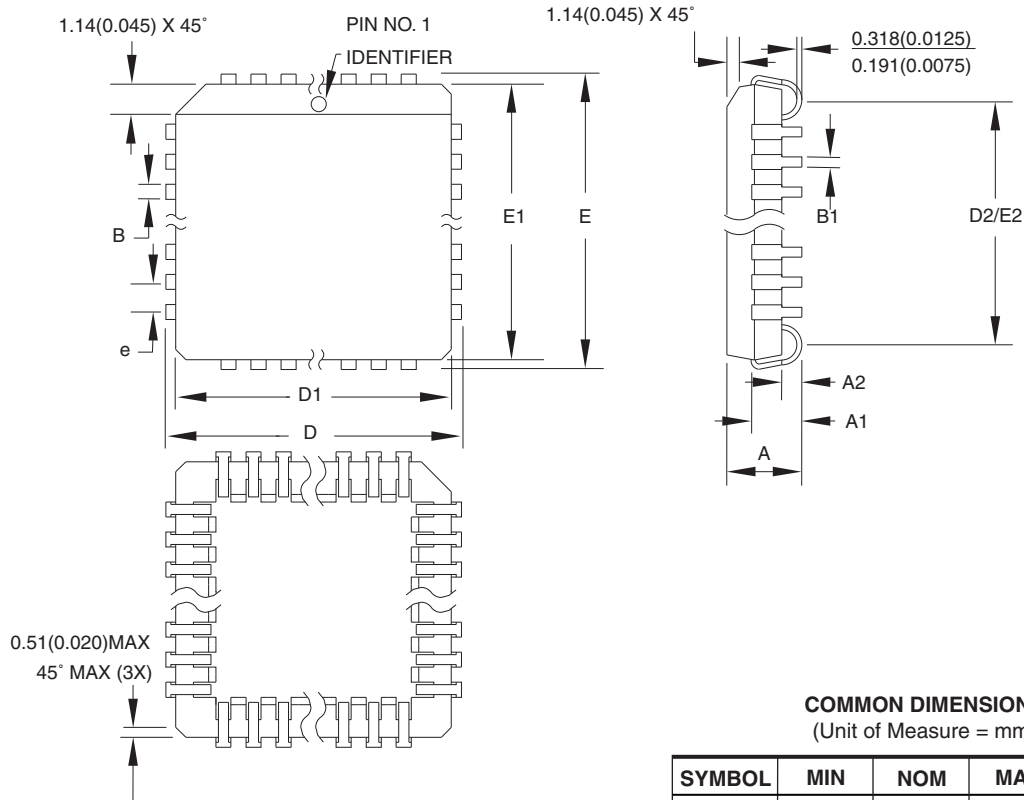

- Notes:
1. This package conforms to JEDEC reference MS-018, Variation AB.
 2. Dimensions D1 and E1 do not include mold protrusion. Allowable protrusion is .010"(0.254 mm) per side. Dimension D1 and E1 include mold mismatch and are measured at the extreme material condition at the upper or lower parting line.
 3. Lead coplanarity is 0.004" (0.102 mm) maximum.

10/04/01



2325 Orchard Parkway
San Jose, CA 95131

TITLE

28J, 28-lead, Plastic J-leaded Chip Carrier (PLCC)

DRAWING NO.

28J

REV.

B

24.2 24P3 – PDIP



COMMON DIMENSIONS
(Unit of Measure = mm)

SYMBOL	MIN	NOM	MAX	NOTE
A	-	-	5.334	
A1	0.381	-	-	
D	31.623	-	32.131	Note 2
E	7.620	-	8.255	
E1	6.096	-	7.112	Note 2
B	0.356	-	0.559	
B1	1.270	-	1.651	
L	2.921	-	3.810	
C	0.203	-	0.356	
eB	-	-	10.922	
eC	0.000	-	1.524	
e	2.540 TYP			

- Notes:
1. This package conforms to JEDEC reference MS-001, Variation AF.
 2. Dimensions D and E1 do not include mold Flash or Protrusion. Mold Flash or Protrusion shall not exceed 0.25 mm (0.010").

6/1/04



2325 Orchard Parkway
San Jose, CA 95131

TITLE

**24P3, 24-lead (0.300"/7.62 mm Wide) Plastic Dual
Inline Package (PDIP)**

DRAWING NO.

24P3

REV.

D



24.3 24S – SOIC



COMMON DIMENSIONS
(Unit of Measure = mm)

SYMBOL	MIN	NOM	MAX	NOTE
A	–	–	2.65	
A1	0.10	–	0.30	
D	10.00	–	10.65	
D1	7.40	–	7.60	
E	15.20	–	15.60	
B	0.33	–	0.51	
L	0.40	–	1.27	
L1	0.23	–	0.32	
e	1.27 BSC			

06/17/2002



2325 Orchard Parkway
San Jose, CA 95131

TITLE

24S, 24-lead (0.300" body) Plastic Gull Wing Small Outline (SOIC)

DRAWING NO.

24S

REV.

B

24.4 24X – TSSOP

Dimensions in Millimeter and (Inches)*
 JEDEC STANDARD MO-153 AD
 Controlling dimension: millimeters

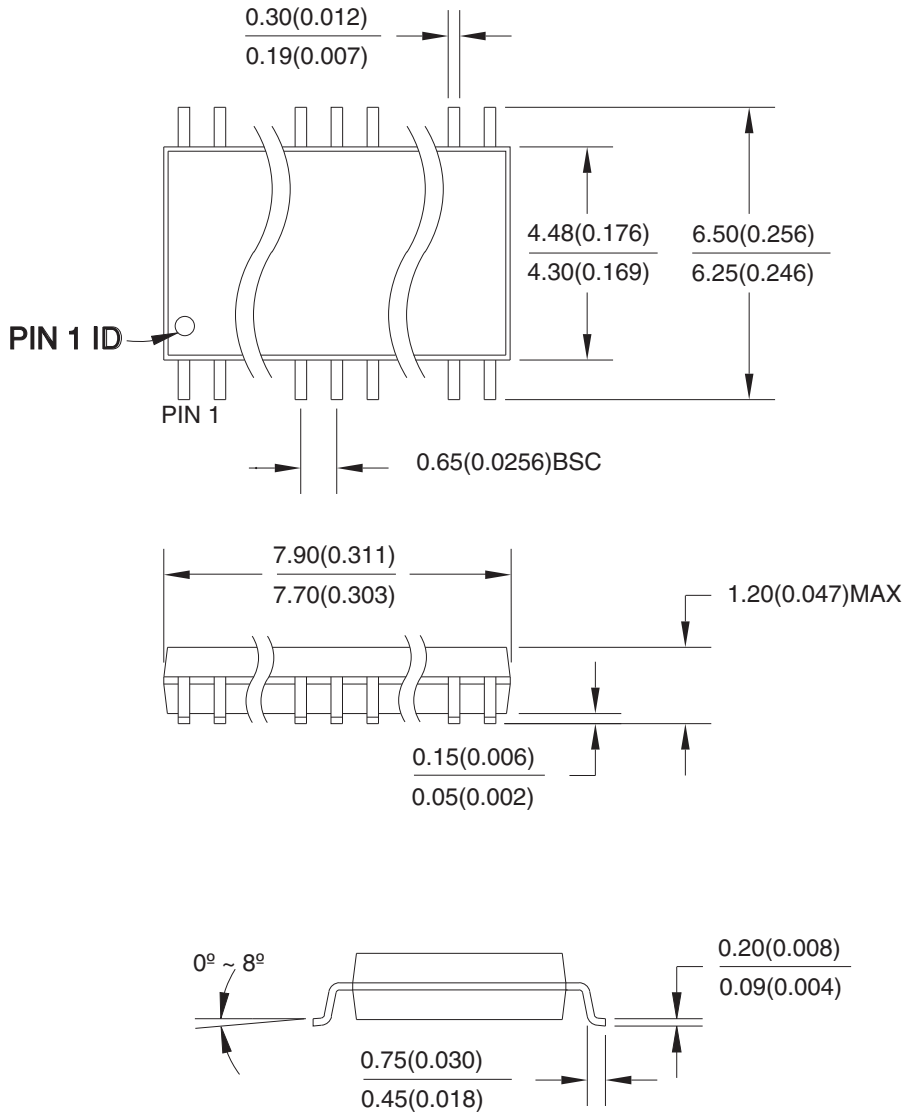

04/11/2001



2325 Orchard Parkway
 San Jose, CA 95131

TITLE

24X, 24-lead (4.4 mm body width) Plastic Thin Shrink Small Outline Package (TSSOP)

DRAWING NO.

24X

REV.

A





25. Revision History

Revision Level – Release Date	History
F – November 2008	Updated datasheet with extended voltage range offering. Removed the leaded parts offering.





Headquarters

Atmel Corporation
2325 Orchard Parkway
San Jose, CA 95131
USA
Tel: 1(408) 441-0311
Fax: 1(408) 487-2600

International

Atmel Asia
Unit 1-5 & 16, 19/F
BEA Tower, Millennium City 5
418 Kwun Tong Road
Kwun Tong, Kowloon
Hong Kong
Tel: (852) 2245-6100
Fax: (852) 2722-1369

Atmel Europe
Le Krebs
8, Rue Jean-Pierre Timbaud
BP 309
78054 Saint-Quentin-en-
Yvelines Cedex
France
Tel: (33) 1-30-60-70-00
Fax: (33) 1-30-60-71-11

Atmel Japan
9F, Tonetsu Shinkawa Bldg.
1-24-8 Shinkawa
Chuo-ku, Tokyo 104-0033
Japan
Tel: (81) 3-3523-3551
Fax: (81) 3-3523-7581

Product Contact

Web Site
www.atmel.com

Technical Support
PLD@atmel.com

Sales Contact
www.atmel.com/contacts

Literature Requests
www.atmel.com/literature

Disclaimer: The information in this document is provided in connection with Atmel products. No license, express or implied, by estoppel or otherwise, to any intellectual property right is granted by this document or in connection with the sale of Atmel products. **EXCEPT AS SET FORTH IN ATMEL'S TERMS AND CONDITIONS OF SALE LOCATED ON ATMEL'S WEB SITE, ATMEL ASSUMES NO LIABILITY WHATSOEVER AND DISCLAIMS ANY EXPRESS, IMPLIED OR STATUTORY WARRANTY RELATING TO ITS PRODUCTS INCLUDING, BUT NOT LIMITED TO, THE IMPLIED WARRANTY OF MERCHANTABILITY, FITNESS FOR A PARTICULAR PURPOSE, OR NON-INFRINGEMENT. IN NO EVENT SHALL ATMEL BE LIABLE FOR ANY DIRECT, INDIRECT, CONSEQUENTIAL, PUNITIVE, SPECIAL OR INCIDENTAL DAMAGES (INCLUDING, WITHOUT LIMITATION, DAMAGES FOR LOSS OF PROFITS, BUSINESS INTERRUPTION, OR LOSS OF INFORMATION) ARISING OUT OF THE USE OR INABILITY TO USE THIS DOCUMENT, EVEN IF ATMEL HAS BEEN ADVISED OF THE POSSIBILITY OF SUCH DAMAGES.** Atmel makes no representations or warranties with respect to the accuracy or completeness of the contents of this document and reserves the right to make changes to specifications and product descriptions at any time without notice. Atmel does not make any commitment to update the information contained herein. Unless specifically provided otherwise, Atmel products are not suitable for, and shall not be used in, automotive applications. Atmel's products are not intended, authorized, or warranted for use as components in applications intended to support or sustain life.

© 2008 Atmel Corporation. All rights reserved. Atmel®, Atmel logo and combinations thereof, and others are registered trademarks or trademarks of Atmel Corporation or its subsidiaries. Other terms and product names may be trademarks of others.

Mouser Electronics

Authorized Distributor

Click to View Pricing, Inventory, Delivery & Lifecycle Information:

[Microchip:](#)

[ATF750LVC-15JU](#) [ATF750LVC-15PU](#) [ATF750LVC-15SU](#) [ATF750LVC-15XU](#)



Компания «ЭлектроПласт» предлагает заключение долгосрочных отношений при поставках импортных электронных компонентов на взаимовыгодных условиях!

Наши преимущества:

- Оперативные поставки широкого спектра электронных компонентов отечественного и импортного производства напрямую от производителей и с крупнейших мировых складов;
- Поставка более 17-ти миллионов наименований электронных компонентов;
- Поставка сложных, дефицитных, либо снятых с производства позиций;
- Оперативные сроки поставки под заказ (от 5 рабочих дней);
- Экспресс доставка в любую точку России;
- Техническая поддержка проекта, помощь в подборе аналогов, поставка прототипов;
- Система менеджмента качества сертифицирована по Международному стандарту ISO 9001;
- Лицензия ФСБ на осуществление работ с использованием сведений, составляющих государственную тайну;
- Поставка специализированных компонентов (Xilinx, Altera, Analog Devices, Intersil, Interpoint, Microsemi, Aeroflex, Peregrine, Syfer, Eurofarad, Texas Instrument, Miteq, Cobham, E2V, MA-COM, Hittite, Mini-Circuits, General Dynamics и др.);

Помимо этого, одним из направлений компании «ЭлектроПласт» является направление «Источники питания». Мы предлагаем Вам помощь Конструкторского отдела:

- Подбор оптимального решения, техническое обоснование при выборе компонента;
- Подбор аналогов;
- Консультации по применению компонента;
- Поставка образцов и прототипов;
- Техническая поддержка проекта;
- Защита от снятия компонента с производства.



Как с нами связаться

Телефон: 8 (812) 309 58 32 (многоканальный)

Факс: 8 (812) 320-02-42

Электронная почта: org@eplast1.ru

Адрес: 198099, г. Санкт-Петербург, ул. Калинина, дом 2, корпус 4, литера А.