

Silicon carbide Power MOSFET 1200 V, 45 A, 90 mΩ (typ., $T_J = 150\text{ °C}$) in an HiP247™ package

Datasheet - production data

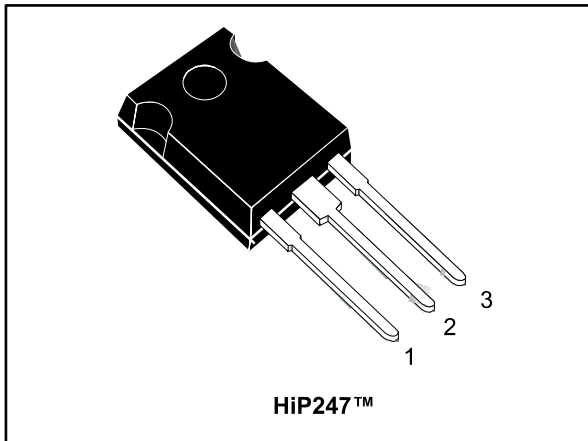

Figure 1: Internal schematic diagram

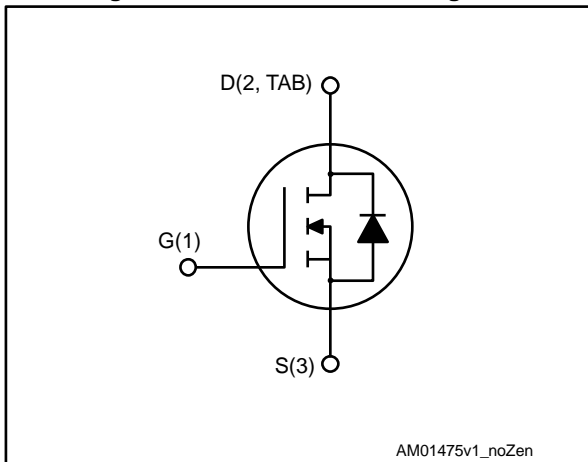

Table 1: Device summary

Order code	Marking	Package	Packaging
SCT30N120	SCT30N120	HiP247™	Tube

Features

- Very tight variation of on-resistance vs. temperature
- Very high operating junction temperature capability ($T_J = 200\text{ °C}$)
- Very fast and robust intrinsic body diode
- Low capacitance

Applications

- Solar inverters, UPS
- Motor drives
- High voltage DC-DC converters
- Switch mode power supply

Description

This silicon carbide Power MOSFET is produced exploiting the advanced, innovative properties of wide bandgap materials. This results in unsurpassed on-resistance per unit area and very good switching performance almost independent of temperature. The outstanding thermal properties of the SiC material, combined with the device's housing in the proprietary HiP247™ package, allows designers to use an industry standard outline with significantly improved thermal capability. These features render the device perfectly suitable for high-efficiency and high power density applications.

Contents

1	Electrical ratings	3
2	Electrical characteristics	4
	2.1 Electrical characteristics (curves).....	6
3	Package information	10
	3.1 HiP247 package information	10
4	Revision history	12

1 Electrical ratings

Table 2: Absolute maximum ratings

Symbol	Parameter	Value	Unit
V_{DS}	Drain-source voltage	1200	V
V_{GS}	Gate-source voltage	-10 to 25	V
I_D	Drain current (continuous) at $T_C = 25\text{ °C}$ (limited by die)	45	A
I_D	Drain current (continuous) at $T_C = 25\text{ °C}$ (limited by package)	40	A
I_D	Drain current (continuous) at $T_C = 100\text{ °C}$	34	A
$I_{DM}^{(1)}$	Drain current (pulsed)	90	A
P_{TOT}	Total dissipation at $T_C = 25\text{ °C}$	270	W
T_{stg}	Storage temperature range	-55 to 200	°C
T_j	Operating junction temperature range		°C

Notes:

⁽¹⁾Pulse width limited by safe operating area.

Table 3: Thermal data

Symbol	Parameter	Value	Unit
$R_{thj-case}$	Thermal resistance junction-case	0.65	°C/W
$R_{thj-amb}$	Thermal resistance junction-ambient	40	°C/W

2 Electrical characteristics

($T_{CASE} = 25\text{ °C}$ unless otherwise specified).

Table 4: On/off states

Symbol	Parameter	Test conditions	Min.	Typ.	Max.	Unit
I_{DSS}	Zero gate voltage drain current	$V_{DS} = 1200\text{ V}; V_{GS} = 0\text{ V}$		1	25	μA
		$V_{DS} = 1200\text{ V}, V_{GS} = 0\text{ V}, T_J = 200\text{ °C}$		50		μA
I_{GSS}	Gate-body leakage current	$V_{DS} = 0\text{ V}; V_{GS} = -10\text{ to }22\text{ V}$			± 100	nA
$V_{GS(th)}$	Gate threshold voltage	$V_{DS} = V_{GS}, I_D = 1\text{ mA}$	1.8	3.5		V
$R_{DS(on)}$	Static drain-source on- resistance	$V_{GS} = 20\text{ V}, I_D = 20\text{ A}$		80	100	m Ω
		$V_{GS} = 20\text{ V}, I_D = 20\text{ A}, T_J = 150\text{ °C}$		90		m Ω
		$V_{GS} = 20\text{ V}, I_D = 20\text{ A}, T_J = 200\text{ °C}$		100		m Ω

Table 5: Dynamic

Symbol	Parameter	Test conditions	Min.	Typ.	Max.	Unit
C_{iss}	Input capacitance	$V_{DS} = 400\text{ V}, f = 1\text{ MHz}, V_{GS} = 0\text{ V}$	-	1700	-	pF
C_{oss}	Output capacitance		-	130	-	pF
C_{rss}	Reverse transfer capacitance		-	25	-	pF
Q_g	Total gate charge	$V_{DD} = 800\text{ V}, I_D = 20\text{ A}, V_{GS} = 0\text{ to }20\text{ V}$	-	105	-	nC
Q_{gs}	Gate-source charge		-	16	-	nC
Q_{gd}	Gate-drain charge		-	40	-	nC
R_g	Gate input resistance	f=1 MHz open drain	-	5	-	Ω

Table 6: Switching energy (inductive load)

Symbol	Parameter	Test conditions	Min.	Typ.	Max.	Unit
E_{on}	Turn-on switching energy	$V_{DD} = 800\text{ V}, I_D = 20\text{ A}, R_G = 6.8\text{ }\Omega, V_{GS} = -2\text{ to }20\text{ V}$	-	500	-	μJ
E_{off}	Turn-off switching energy		-	350	-	μJ
E_{on}	Turn-on switching energy	$V_{DD} = 800\text{ V}, I_D = 20\text{ A}, R_G = 6.8\text{ }\Omega, V_{GS} = -2\text{ to }20\text{ V}, T_J = 150\text{ °C}$	-	500	-	μJ
E_{off}	Turn-off switching energy		-	400	-	μJ

Table 7: Switching times

Symbol	Parameter	Test conditions	Min.	Typ.	Max.	Unit
$t_{d(on)}$	Turn-on delay time	$V_{DD} = 800\text{ V}, I_D = 20\text{ A}, R_G = 0\text{ }\Omega, V_{GS} = 0\text{ to }20\text{ V}$	-	19	-	ns
t_f	Fall time		-	28	-	ns
$t_{d(off)}$	Turn-off delay time		-	45	-	ns
t_r	Rise time		-	20	-	ns

Table 8: Reverse SiC diode characteristics

Symbol	Parameter	Test conditions	Min	Typ.	Max	Unit
V_{SD}	Diode forward voltage	$I_F = 10\text{ A}$, $V_{GS} = 0\text{ V}$	-	3.5	-	V
t_{rr}	Reverse recovery time	$I_{SD} = 20\text{ A}$, $di/dt = 100\text{ A}/\mu\text{s}$ $V_{DD} = 800\text{ V}$	-	140		ns
Q_{rr}	Reverse recovery charge		-	140	-	nC
I_{RRM}	Reverse recovery current		-	2	-	A

2.1 Electrical characteristics (curves)

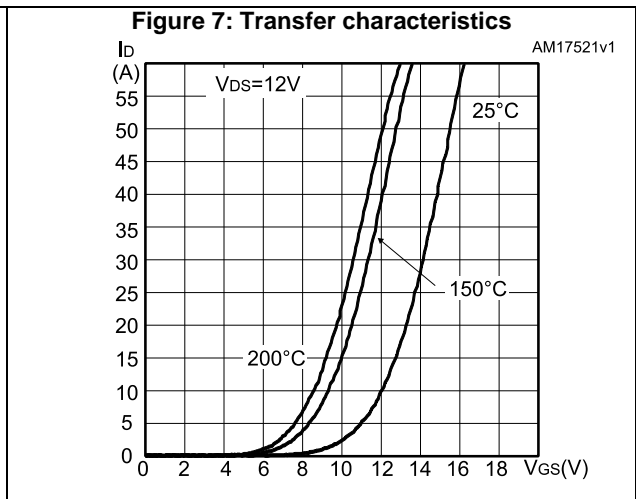
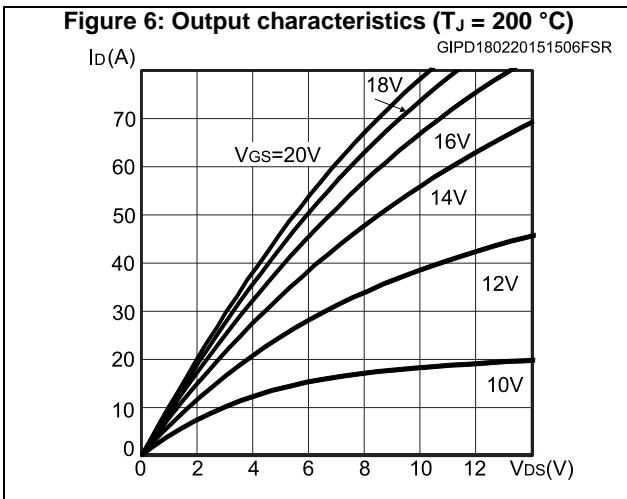
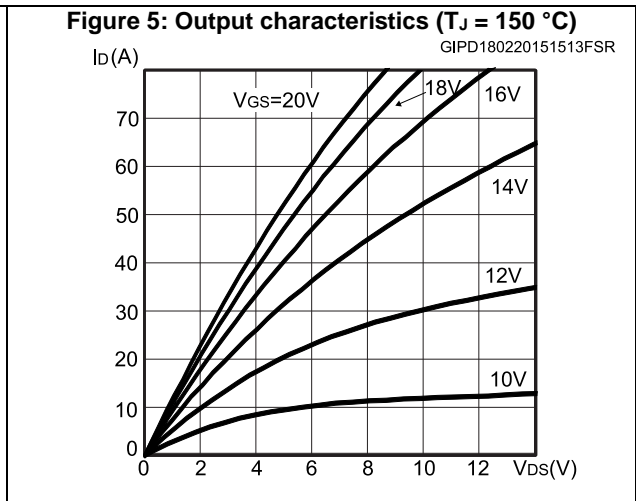
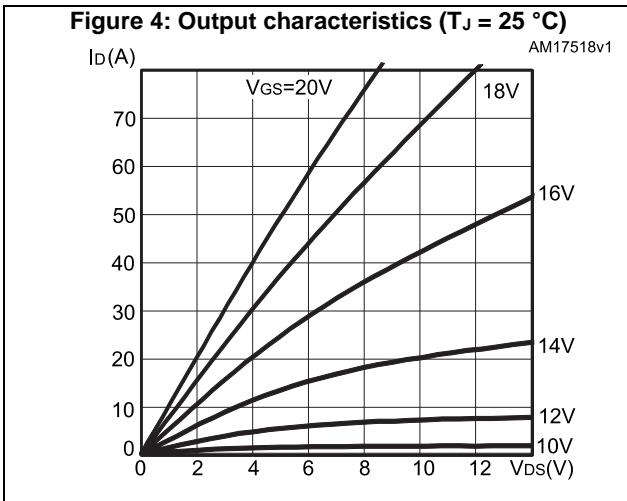
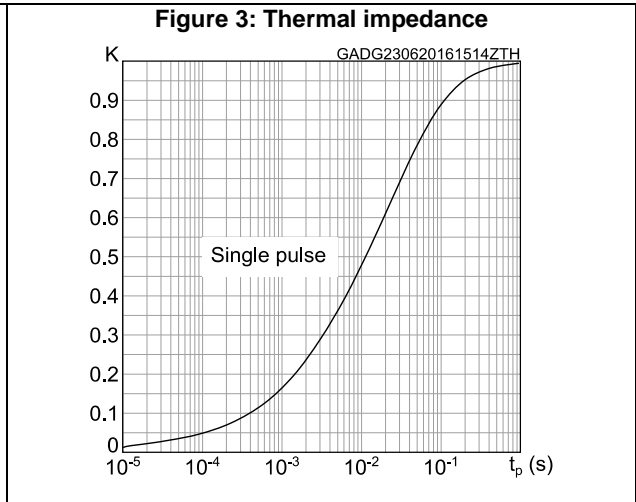
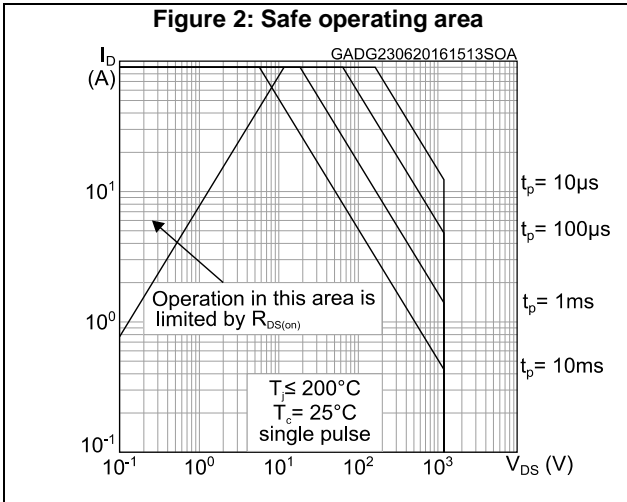

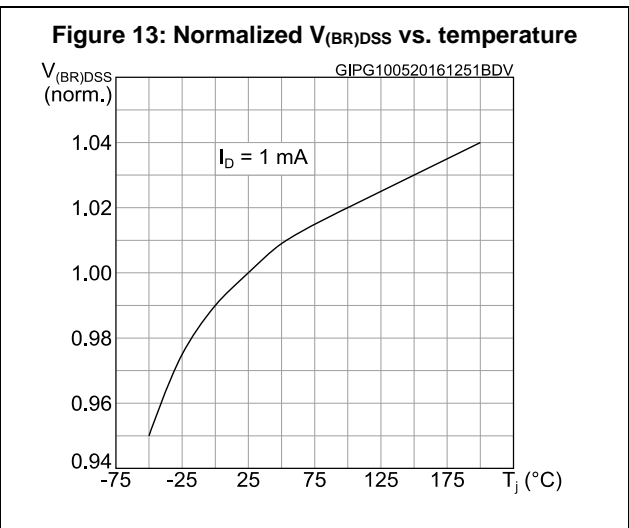
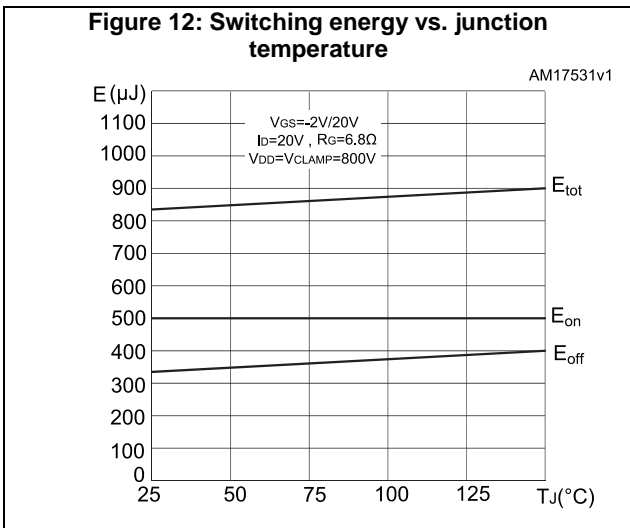
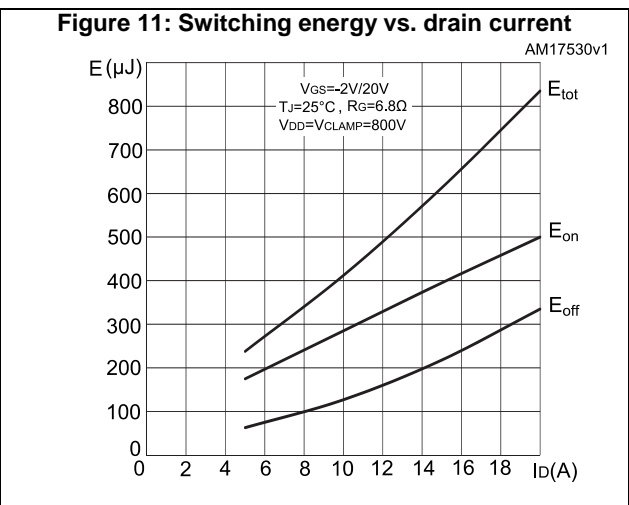
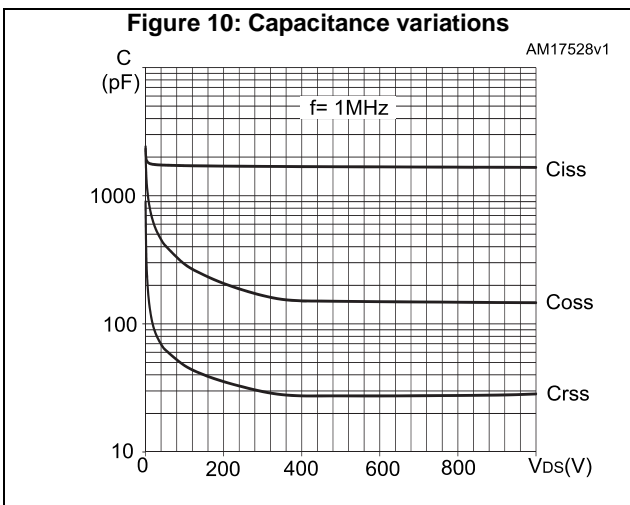
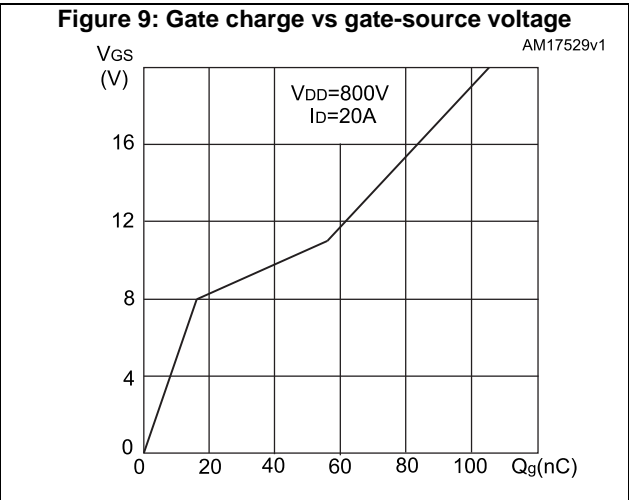
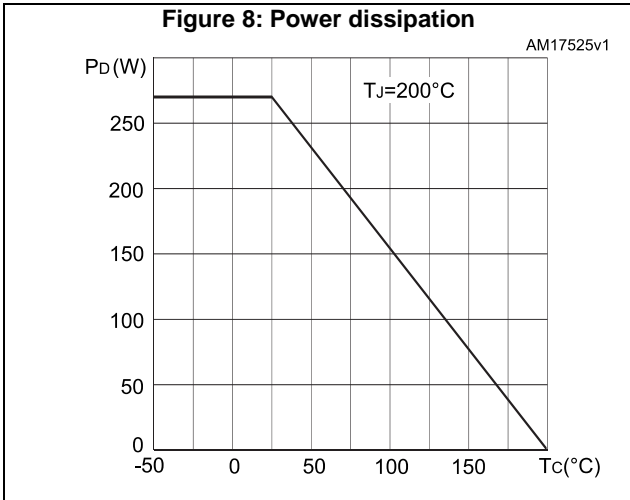

Figure 14: Normalized gate threshold voltage vs. temperature

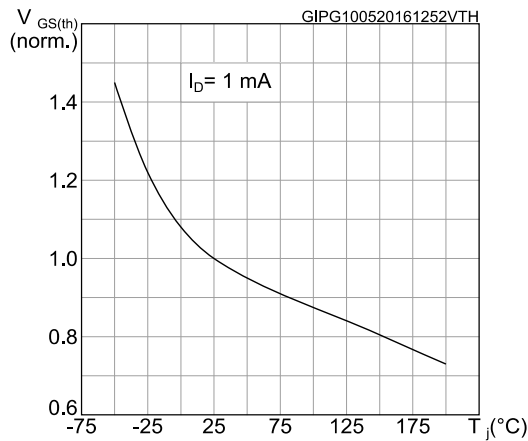

Figure 15: Normalized on-resistance vs. temperature

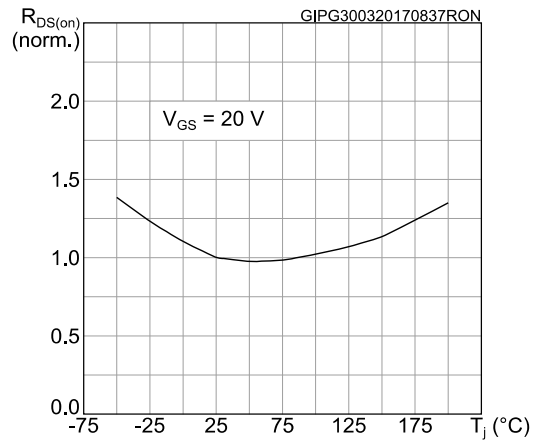

Figure 16: Body diode characteristics (T_J = -50 °C)

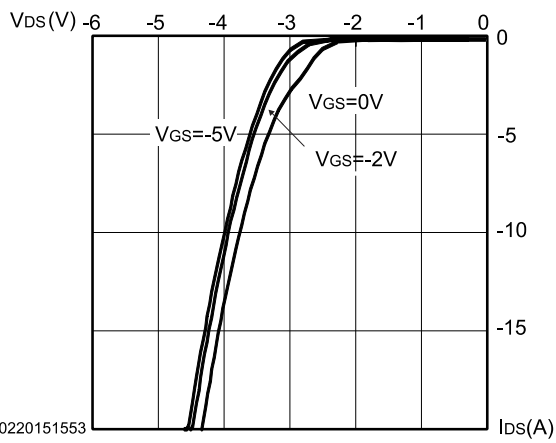

Figure 17: Body diode characteristics (T_J = 25 °C)

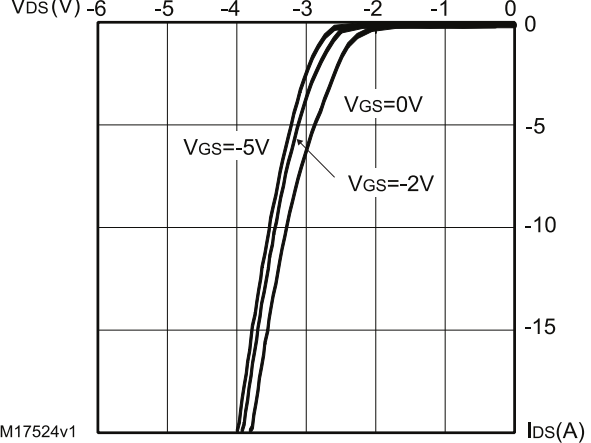

Figure 18: Body diode characteristics (T_J = 150 °C)

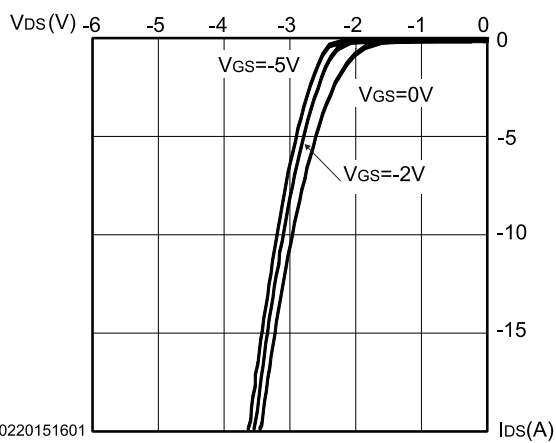

Figure 19: 3rd quadrant characteristics (T_J = -50 °C)

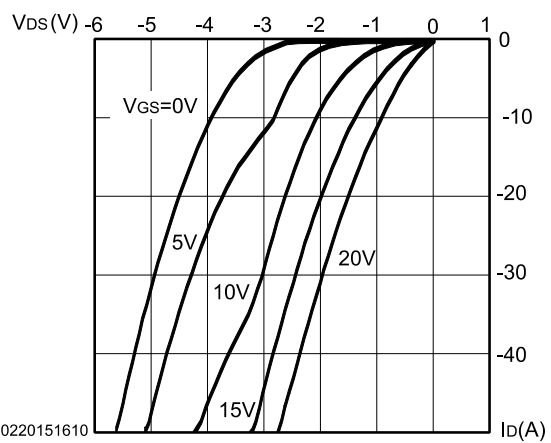

Figure 20: 3rd quadrant characteristics ($T_J = 25\text{ }^\circ\text{C}$)

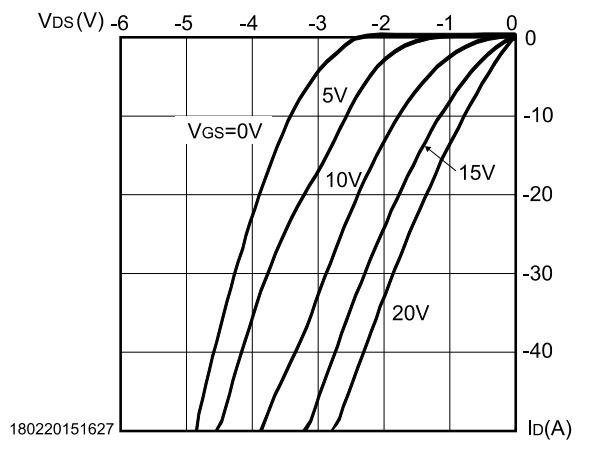
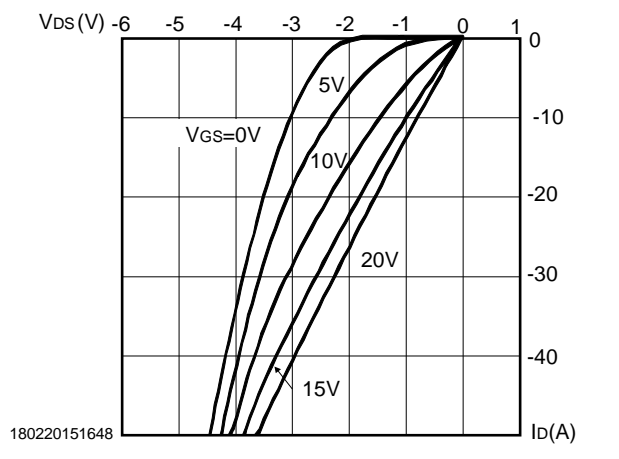

Figure 21: 3rd quadrant characteristics ($T_J = 150\text{ }^\circ\text{C}$)



3 Package information

In order to meet environmental requirements, ST offers these devices in different grades of ECOPACK® packages, depending on their level of environmental compliance. ECOPACK® specifications, grade definitions and product status are available at: www.st.com. ECOPACK® is an ST trademark.

3.1 HiP247 package information

Figure 22: HiP247™ package outline

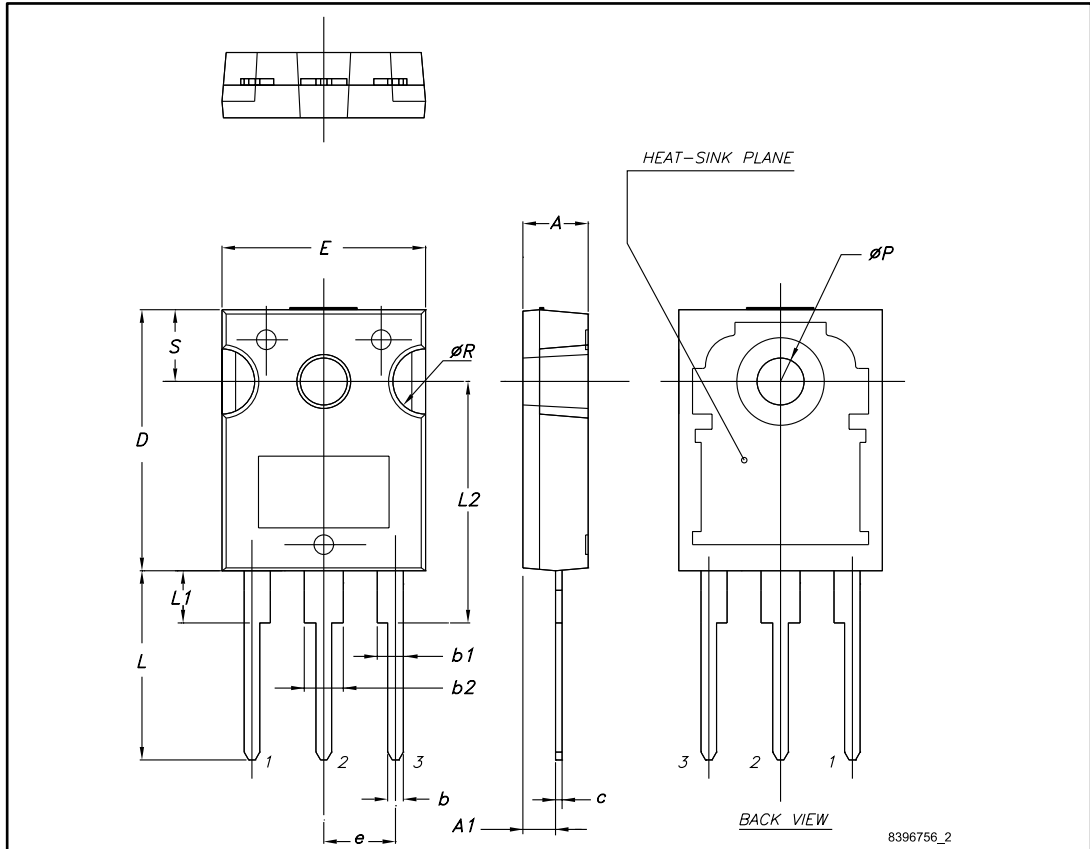

Table 9: HiP247™ package mechanical data

Dim.	mm		
	Min.	Typ.	Max.
A	4.85		5.15
A1	2.20		2.60
b	1.0		1.40
b1	2.0		2.40
b2	3.0		3.40
c	0.40		0.80
D	19.85		20.15
E	15.45		15.75
e	5.30	5.45	5.60
L	14.20		14.80
L1	3.70		4.30
L2		18.50	
ØP	3.55		3.65
ØR	4.50		5.50
S	5.30	5.50	5.70

4 Revision history

Table 10: Document revision history

Date	Revision	Changes
10-May-2012	1	First release
21-May-2013	2	Updated trr value in Table8. Updated dynamic parameters in Table5, VGS(th) in Table4 and Eon in Table6.
24-Jun-2013	3	Document status promoted from target to preliminary data. Added: Section2.1: Electrical characteristics (curves)
11-Jul-2013	4	Updated Figure6: Output characteristics (TJ=200°C) and Figure7: Transfer characteristics.
18-Dec-2013	5	Updated parameters in Table2: Absolute maximum ratings and Table4: On/off states.
27-May-2014	6	Added Table7: Switching times. Updated Section3: Package mechanical data. Minor text changes.
25-Sep-2014	7	Document status promoted from preliminary to production data.
17-Feb-2015	8	Updated title in cover page.
20-Feb-2015	9	Updated Section2.1: Electrical characteristics (curves).
24-Jul-2016	10	Updated title and features in cover page. Updated Figure 2: "Safe operating area" and Figure 3: "Thermal impedance". Minor text changes.
11-May-2017	11	Updated Table 4: "On/off states" and Section 2.1: "Electrical characteristics (curves)". Minor text changes.

IMPORTANT NOTICE – PLEASE READ CAREFULLY

STMicroelectronics NV and its subsidiaries ("ST") reserve the right to make changes, corrections, enhancements, modifications, and improvements to ST products and/or to this document at any time without notice. Purchasers should obtain the latest relevant information on ST products before placing orders. ST products are sold pursuant to ST's terms and conditions of sale in place at the time of order acknowledgement.

Purchasers are solely responsible for the choice, selection, and use of ST products and ST assumes no liability for application assistance or the design of Purchasers' products.

No license, express or implied, to any intellectual property right is granted by ST herein.

Resale of ST products with provisions different from the information set forth herein shall void any warranty granted by ST for such product.

ST and the ST logo are trademarks of ST. All other product or service names are the property of their respective owners.

Information in this document supersedes and replaces information previously supplied in any prior versions of this document.

© 2017 STMicroelectronics – All rights reserved



Компания «ЭлектроПласт» предлагает заключение долгосрочных отношений при поставках импортных электронных компонентов на взаимовыгодных условиях!

Наши преимущества:

- Оперативные поставки широкого спектра электронных компонентов отечественного и импортного производства напрямую от производителей и с крупнейших мировых складов;
- Поставка более 17-ти миллионов наименований электронных компонентов;
- Поставка сложных, дефицитных, либо снятых с производства позиций;
- Оперативные сроки поставки под заказ (от 5 рабочих дней);
- Экспресс доставка в любую точку России;
- Техническая поддержка проекта, помощь в подборе аналогов, поставка прототипов;
- Система менеджмента качества сертифицирована по Международному стандарту ISO 9001;
- Лицензия ФСБ на осуществление работ с использованием сведений, составляющих государственную тайну;
- Поставка специализированных компонентов (Xilinx, Altera, Analog Devices, Intersil, Interpoint, Microsemi, Aeroflex, Peregrine, Syfer, Eurofarad, Texas Instrument, Miteq, Cobham, E2V, MA-COM, Hittite, Mini-Circuits, General Dynamics и др.);

Помимо этого, одним из направлений компании «ЭлектроПласт» является направление «Источники питания». Мы предлагаем Вам помощь Конструкторского отдела:

- Подбор оптимального решения, техническое обоснование при выборе компонента;
- Подбор аналогов;
- Консультации по применению компонента;
- Поставка образцов и прототипов;
- Техническая поддержка проекта;
- Защита от снятия компонента с производства.



Как с нами связаться

Телефон: 8 (812) 309 58 32 (многоканальный)

Факс: 8 (812) 320-02-42

Электронная почта: org@eplast1.ru

Адрес: 198099, г. Санкт-Петербург, ул. Калинина, дом 2, корпус 4, литера А.