

# General Specifications

## Electrical Capacity (Resistive Load)

<b>For MRX:</b>	2A @ 125V AC or 1A @ 30V DC
<b>For MRY:</b>	For MRY106G: 0.4VA maximum @ 28V AC/DC maximum (Applicable Range 0.1mA ~ 0.1A @ 20mV ~ 28V) Note: See Supplement Index to find explanation of operating range. For all other MRY models: 3A @ 125V AC or 2A @ 30V DC
<b>For MRT:</b>	For MRT22: 10A @ 125V AC or 4A @ 30V DC For MRT23: 5A @ 125V AC or 3A @ 30V DC

## Other Ratings

<b>Contact Resistance:</b>	10 milliohms maximum for MRX, MRY, & MRT; 20 milliohms maximum for MRY106G
<b>Insulation Resistance:</b>	100 megohms minimum @ 500V DC for MRX & MRY 200 megohms minimum @ 500V DC for MRT
<b>Dielectric Strength:</b>	1,000V AC minimum for 1 minute minimum
<b>Mechanical Life:</b>	15,000 operations minimum
<b>Electrical Life:</b>	7,500 operations minimum
<b>Range of Operating Torque:</b>	0.03 ~ 0.15Nm for MRX; 0.02 ~ 0.10Nm for MRY; 0.02 ~ 0.05Nm for MRT
<b>Contact Timing:</b>	Nonshorting (break-before-make) MRX: Self-cleaning, sliding contact; MRY: Rotary contactor dish; MRT: Butt contacts
<b>Indexing:</b>	45° for MRX; 60° for MRY; 120° for MRT22; 60° for MRT23

## Materials & Finishes

<b>Shaft:</b>	Brass with nickel plating
<b>Stopper Plate:</b>	Steel with zinc plating for MRX & MRY
<b>Bushing/Housing:</b>	Brass with nickel plating
<b>Movable Contacts:</b>	Silver alloy for MRX & MRT; copper with silver plating for MRY106; copper with gold plating for MRY106G
<b>End Contacts &amp; Terminals:</b>	Silver alloy & copper with silver plating for MRX & MRT; silver alloy plus brass with silver plating for MRY106; silver alloy with gold plating for MRY106G
<b>Common Contacts &amp; Terminals:</b>	Copper with silver plating for MRX, MRY106 & MRT22; brass with gold plating for MRY106G; brass with silver plating for MRT23
<b>Base:</b>	Phenolic resin

## Environmental Data

<b>Operating Temperature Range:</b>	-10°C through +70°C (+14°F through +158°F)
<b>Humidity:</b>	90 ~ 95% humidity for 96 hours @ 40°C (104°F)
<b>Vibration:</b>	10 ~ 55Hz with peak-to-peak amplitude of 1.5mm traversing the frequency range & returning in 1 minute; 3 right angled directions for 2 hours
<b>Shock:</b>	50G (490m/s <sup>2</sup> ) acceleration (tested in 3 right angled directions, with 3 shocks in each direction)

## Installation

<b>Mounting Torque:</b>	.686Nm (6.08 lb•in)
<b>Cap Installation Force:</b>	19.6 ~ 29.4N (4.41 ~ 6.61 lbf)
<b>Soldering Time &amp; Temperature:</b>	Manual Soldering: See Profile A in Supplement section.

## Standards & Certifications

<b>UL:</b>	<b>File No. E44145 - Recognized only when ordered with marking on switch.</b> Add "/U" or "/CUL" before dash in part number to order UL recognized switch. MRT22 models recognized at 10A @ 125V AC; MRT23 models recognized at 5A @ 125V AC
------------	--

# Distinctive Characteristics

Positive detent mechanism for distinct feel and audible feedback.

Metal bushing and housing construction increases durability.

Adjustable stopper plate allows 2-8 position settings.

High contact reliability achieved by the self-cleaning contact mechanism.

Break-before-make contact timing with various mechanism types: sliding contacts in MRX, contactor dish in MRY, and butt contacts in MRT models.

Terminal types include PC-turret for MRX, turret for MRY, and solder lug for MRT models.

Molded-in PC-turret and turret terminals prevent entry of flux and other contaminants.



Actual Size



- Toggle
- Rockers
- Pushbuttons
- Illuminated PB
- Programmable
- Keylocks
- Rotaries**
- Slides
- Tactiles
- Tilt
- Touch
- Indicators
- Accessories
- Supplement

## TYPICAL SWITCH ORDERING EXAMPLE

**MR**

**X**

**108**

**A**



### Actuators & Terminals

**X** Shaft Actuated with PC-Turret Terminals

**Y** Shaft Actuated with Turret Terminals

**T** Shaft Actuated with Solder Lug Terminals \*

### Poles & Circuits

<b>108</b>	SP with 2-8 Positions
<b>204</b>	DP with 2-4 Positions
<b>402</b>	4P with 2 Positions

<b>106</b>	SP with 2-6 Positions
<b>106G</b>	SP with 2-6 Positions Gold Contacts 0.4VA

<b>22</b>	DPDT ON-NONE-ON
<b>23</b>	DPDT ON-OFF-ON

### Knobs

<b>A</b>	Plain Black
<b>B</b>	Small Color Tipped
<b>C</b>	Large Color Tipped

### Colors

For Plain Knob	
<b>No Code</b>	Black
For Color Tipped	
<b>A</b>	Black
<b>B</b>	White
<b>C</b>	Red
<b>E</b>	Yellow
<b>F</b>	Green
<b>G</b>	Blue
<b>H</b>	Gray

\* Wire harness & cable assemblies offered only in Americas

### DESCRIPTION FOR TYPICAL ORDERING EXAMPLE

**MRX108-A**

Shaft Actuated with Plain Black Knob

SP with 2-8 Adjustable Positions

PC-Turret Terminals



### IMPORTANT:



MRT Switches are supplied without UL & cULus marking unless specified. **UL & cULus recognized only when ordered with marking on the switch.** Specific models, ratings, & ordering instructions are noted on General Specifications page.

## ACTUATORS & TERMINALS

**X** Shaft Actuated with PC-Turret Terminals

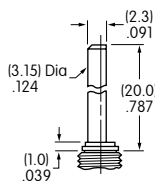

Shaft

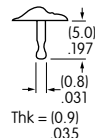

Terminal

**Y** Shaft Actuated with Turret Terminals

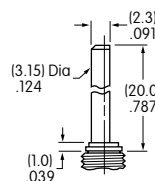

Shaft

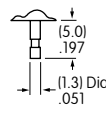

Terminal

**T** Shaft Actuated with Solder Lug Terminals

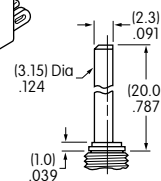

Shaft



Terminal

POLES & CIRCUITS					
Pole	Model	Number of Positions	Stopper Settings	Number of Terminals	Schematics
SP	MRX108	2-8	2, 3, 4, 5, 6, 7, 8	1 COM, 8 LOAD	
	MRY106 MRY106G	2-6	2, 3, 4, 5, 6	1 COM, 6 LOAD	
DP	MRX204	2-4	2, 3, 4	2 COM, 8 LOAD	
DPDT	MRT22	2	ON-NONE-ON	2-3 2-1 5-6 5-4	
	MRT23	3	ON-OFF-ON	2-3 OPEN 2-1 5-6 OPEN 5-4	
4P	MRX402	2	1 & 2	4 COM, 8 LOAD	

## POSITION SETTING FOR MRX & MRY MODELS

Each switch is supplied with the stopper set for the maximum number of positions allowed for that model. Prior to installation, the desired position setting should be made. Contact factory for continuous rotation.

- Using the actuator knob, turn the shaft counterclockwise to the extreme left. If the shaft is not turned to this extreme position where the white line on the knob points to the number 1 position shown on the side of the switch, proper setting cannot be achieved.
- Remove the knob from the shaft and loosen the nut far enough to allow raising the stopper plate for resetting to the desired position.
- Note the position numbers on the side of the switch; these correspond to the terminal numbers and stopper holes. Insert the stopper in the hole numbered for the maximum desired number of stop settings. Satisfactory switch functioning cannot be assured if the stopper plate is not properly positioned.
- Tighten the nub (beveled side up) firmly against the stopper plate.

### Mounting Hardware Packaged Loose with Each Switch

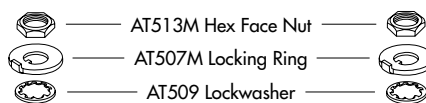

### Factory Assembled:

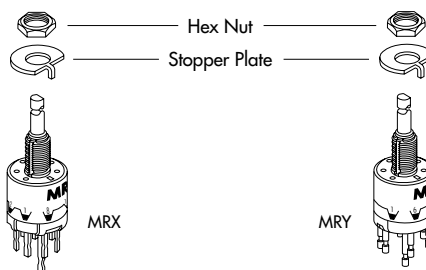

## TYPICAL SWITCH DIMENSIONS

### Single, Double & Four Pole

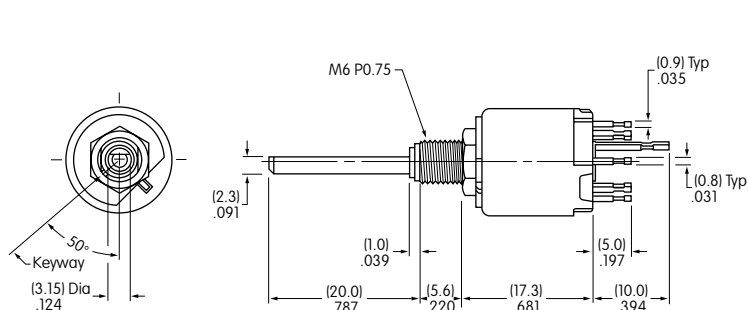

### MRX • PC-Turret Terminals

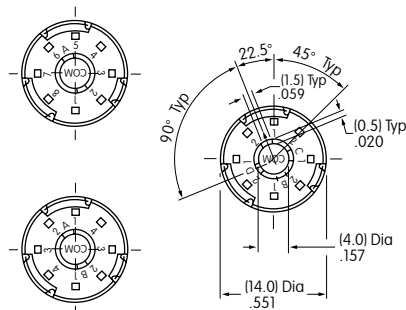

MRX108

Toggles  
Rockers  
Pushbuttons  
Illuminated PB  
Programmable  
Keylocks  
Rotaries  
Slides  
Tactiles  
Tilt  
Touch  
Indicators  
Accessories  
Supplement

## TYPICAL SWITCH DIMENSIONS

### MRY • Turret Terminals

### Single Pole



MRY106

### MRT • Solder Lug Terminals

### Double Pole



MRT22

## PC FOOTPRINTS FOR MRX SINGLE, DOUBLE, & FOUR POLE

### Single Pole

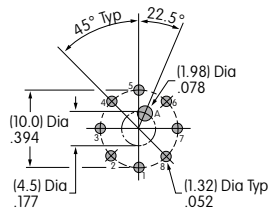

### Double Pole

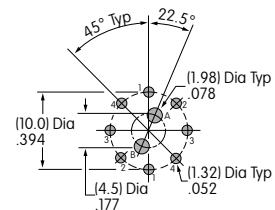

### Four Pole



Toggles  
 Rockers  
 Pushbuttons  
 Illuminated PB  
 Programmable  
 Keylocks  
 Rotaries  
 Slides  
 Tactiles  
 Tilt  
 Touch  
 Indicators  
 Accessories  
 Supplement

## KNOBS

**A** AT433  
Plain Black

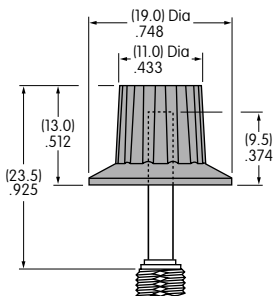

Material: Polyacetal

Color: Black only

**B** AT4103 Small  
Color Tipped

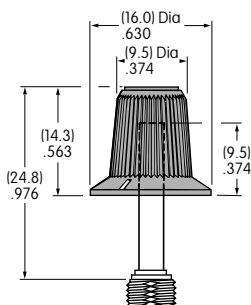

Base Material: Polyester

Base Color: Black

Polyamide Tip

Colors: A, B, C, E, F, G, H

**C** AT4104 Large  
Color Tipped

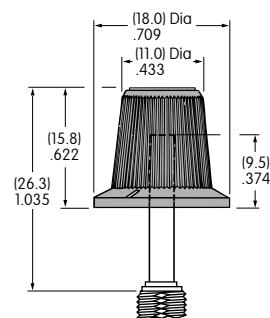

Base Material: Polyester

Base Color: Black

Polyamide Tip

Colors: A, B, C, E, F, G, H

Color Codes:

**A** Black

**B** White

**C** Red

**E** Yellow

**F** Green

**G** Blue

**H** Gray

## PANEL CUTOUTS & MAXIMUM EFFECTIVE PANEL THICKNESS

Without  
Keyway

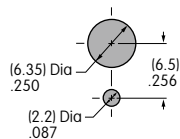

With  
Keyway

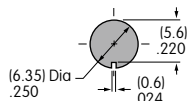

Maximum Effective Panel Thickness

With Standard Hardware: MRX & MRY .095" (2.4mm); MRT .106" (2.7mm)

Without Locking Ring: MRX & MRY .126" (3.2mm); MRT .138" (3.5mm)



Компания «ЭлектроПласт» предлагает заключение долгосрочных отношений при поставках импортных электронных компонентов на взаимовыгодных условиях!

Наши преимущества:

- Оперативные поставки широкого спектра электронных компонентов отечественного и импортного производства напрямую от производителей и с крупнейших мировых складов;
- Поставка более 17-ти миллионов наименований электронных компонентов;
- Поставка сложных, дефицитных, либо снятых с производства позиций;
- Оперативные сроки поставки под заказ (от 5 рабочих дней);
- Экспресс доставка в любую точку России;
- Техническая поддержка проекта, помощь в подборе аналогов, поставка прототипов;
- Система менеджмента качества сертифицирована по Международному стандарту ISO 9001;
- Лицензия ФСБ на осуществление работ с использованием сведений, составляющих государственную тайну;
- Поставка специализированных компонентов (Xilinx, Altera, Analog Devices, Intersil, Interpoint, Microsemi, Aeroflex, Peregrine, Syfer, Eurofarad, Texas Instrument, Miteq, Cobham, E2V, MA-COM, Hittite, Mini-Circuits, General Dynamics и др.);

Помимо этого, одним из направлений компании «ЭлектроПласт» является направление «Источники питания». Мы предлагаем Вам помощь Конструкторского отдела:

- Подбор оптимального решения, техническое обоснование при выборе компонента;
- Подбор аналогов;
- Консультации по применению компонента;
- Поставка образцов и прототипов;
- Техническая поддержка проекта;
- Защита от снятия компонента с производства.



#### Как с нами связаться

**Телефон:** 8 (812) 309 58 32 (многоканальный)

**Факс:** 8 (812) 320-02-42

**Электронная почта:** [org@eplast1.ru](mailto:org@eplast1.ru)

**Адрес:** 198099, г. Санкт-Петербург, ул. Калинина, дом 2, корпус 4, литера А.