

# AN-REF-15W\_C61K5-THINPAK ADAPTER

## 15 W 5 V Adapter Reference Board with ICE2QS03G, IPL65R1K5C6S, BSC067N06LS3 G & BAS21-03W

Application Note

### About this document

#### Scope and purpose

This document is an engineering report that describes 15 W 5 V USB adapter reference design board using Infineon Quasi-Resonant PWM IC ICE2QS03G with CoolMOS™ IPL65R1K5C6S (ThinPAK 5x6) and secondary side synchronous rectification IC with OptiMOS™ BSC067N06LS3 G (ThinPAK 5x6). The reference USB adapter board is specially designed in a very small form factor, high efficiency, low standby power, various modes of protections for a high reliable system and it pass conductive EMI, ESD and Lightning surge test. This board can be used for production by customers after final verification with minor changes.

#### Intended audience

This document is intended for users who wish to design 15 W 5 V AC-DC adapter in short period of time, high efficiency, high reliability and very small form factor with Infineon CoolMOS™ C6 series, OptiMOS™, Quasi-Resonant PWM IC ICE2QS03G and synchronous rectification.

### Table of Contents

<b>About this document .....</b>	<b>1</b>
<b>Table of Contents .....</b>	<b>1</b>
<b>1 Abstract .....</b>	<b>3</b>
<b>2 Reference board .....</b>	<b>3</b>
<b>3 Specification .....</b>	<b>4</b>
<b>4 Circuit description.....</b>	<b>5</b>
4.1 Mains input rectification and filtering.....	5
4.2 PWM control and switching MOSFET .....	5
4.3 Snubber network.....	5
4.4 Output stage .....	5
4.5 Feedback loop .....	5
<b>5 Circuit operation.....</b>	<b>6</b>

**Abstract**

5.1	Startup operation.....	6
5.2	Normal mode operation.....	6
5.3	Primary side peak current control.....	6
5.4	Digital frequency reduction .....	6
5.5	Burst mode operation.....	6
<b>6</b>	<b>Protection features .....</b>	<b>7</b>
6.1	V <sub>CC</sub> over voltage and under voltage protection.....	7
6.2	Over load/Open loop protection .....	7
6.3	Auto restart for over temperature protection.....	7
6.4	Adjustable output overvoltage protection.....	7
6.5	Short winding protection .....	7
6.6	Foldback point protection .....	8
<b>7</b>	<b>Circuit diagram .....</b>	<b>9</b>
<b>8</b>	<b>PCB layout .....</b>	<b>10</b>
8.1	Top side .....	10
8.2	Bottom side.....	10
<b>9</b>	<b>Component list .....</b>	<b>11</b>
<b>10</b>	<b>Transformer construction .....</b>	<b>12</b>
<b>11</b>	<b>Test results .....</b>	<b>13</b>
11.1	Efficiency, regulations and output ripple .....	13
11.2	Standby power .....	14
11.3	Line regulation.....	15
11.4	Load regulation .....	15
11.5	Maximum power.....	16
11.6	ESD immunity (EN61000-4-2).....	16
11.7	Surge immunity (EN61000-4-5).....	16
11.8	Conducted emissions (EN55022 class B) .....	17
11.9	Thermal measurement.....	19
<b>12</b>	<b>Waveforms and scope plots.....</b>	<b>20</b>
12.1	Start up at low/high AC line input voltage with maximum load .....	20
12.2	Soft start.....	20
12.3	Start up delay time & output voltage rise time .....	21
12.4	Hold up time .....	21
12.5	Drain & current sense voltage at maximum load.....	22
12.6	Zero crossing point during normal operation.....	22
12.7	Load transient response (Dynamic load from 1.67% to 100%) .....	23
12.8	Output ripple voltage at maximum load .....	23
12.9	Output ripple voltage during burst mode at 1 W load .....	24
12.10	Active Burst mode operation .....	24
12.11	Over load protection (Auto restart mode).....	25
12.12	Output overvoltage protection (Latched off mode).....	25
12.13	V <sub>CC</sub> under voltage/Short optocoupler protection (Auto restart mode) .....	26
<b>13</b>	<b>References .....</b>	<b>26</b>
<b>Revision History.....</b>		<b>26</b>

Abstract

# 1 Abstract

This application note is an engineering report of a very small form factor reference design for universal input 15 W 5 V adapter. The adapter is using **ICE2QS03G**, a second generation current mode control Quasi-Resonant flyback topology controller, **IPL65R1K5C6S**, a **C6** series of high voltage power CoolMOS™ and **BSC067N06LS3 G**, a third series of medium voltage power logic level OptiMOS™, optimized for logic level driver of Synchronous Rectification. The distinguishing features of this reference design are very small form factor, best-in-class low standby power, very high efficiency, good EMI performance and various modes of protection for high reliable system.

# 2 Reference board

This document contains the list of features, the power supply specification, schematic, bill of material and the transformer construction documentation. Typical operating characteristics such as performance curve and scope waveforms are showed at the rear of the report.



Figure 1 REF-15W\_C61K5-THINPAK ADAPTER [Dimensions L x W x H: 47mm x 31mm x 16mm]

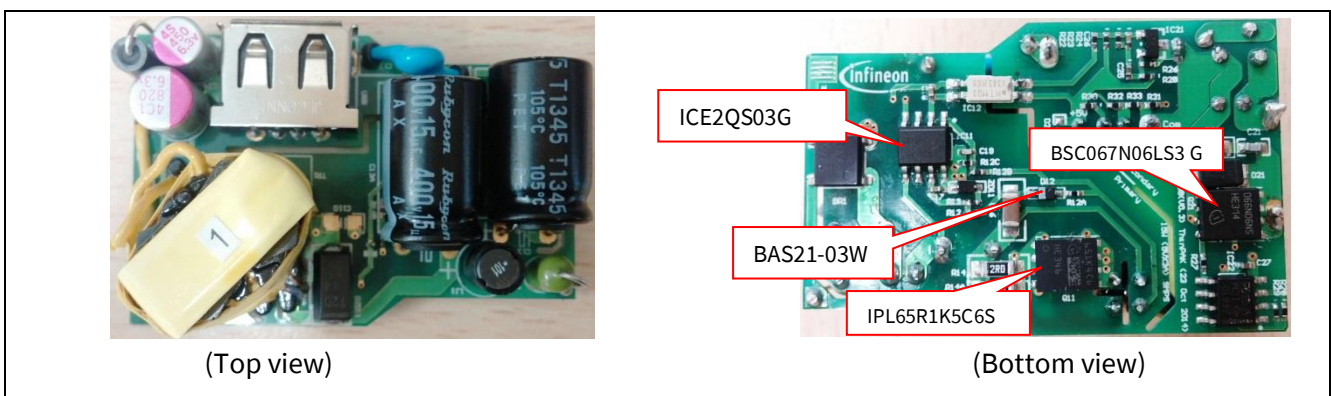

Figure 2 REF-15W\_C61K5-THINPAK ADAPTER [Top & Bottom View]

**Specification**

### 3 Specification

**Table 1 Specification of REF-15W\_C61K5-THINPAK ADAPTER**

Input voltage	85 V <sub>AC</sub> ~265 V <sub>AC</sub>
Input frequency	47~63 Hz
Output voltage, current & power	5 V/3 A/15 W
Output voltage rise time	<30 ms
Start up delay time (V <sub>AC</sub> 115 V, 60 Hz, Full Load)	<250 ms
Hold up time (V <sub>AC</sub> 115 V, 60 Hz, Full Load)	>5 ms
Mains ON/OFF Overshoot (85 V <sub>AC</sub> ~ 265 V <sub>AC</sub> )	+/-3% of nominal output voltage (V <sub>ripple_p_p</sub> <300 mV)
Dynamic load response (50mA to full load, slew rate at 1.5 A/μs, 100 Hz)	+/-3% of nominal output voltage (V <sub>ripple_p_p</sub> <300 mV)
Output ripple voltage (full load, 85 V <sub>AC</sub> ~265 V <sub>AC</sub> )	+/-1% of nominal output voltage (V <sub>ripple_p_p</sub> <100 mV)
Active mode four point average efficiency (25%,50%,75%,100%load) (EU CoC Version 5, Tier 2 and EPS of DOE USA) 10% load efficiency (EU CoC Version 5, Tier 2)	>88% at 115 V <sub>AC</sub> & >87% at 230 V <sub>AC</sub>  >87% at 115 V <sub>AC</sub> & >85% at 230 V <sub>AC</sub>
Conducted emissions (EN55022 class B)	Pass with 8 dB margin
Safety Leakage Current (50 μA @ V <sub>AC</sub> = 265 V,L to FG & N to FG)	<50 μA @ V <sub>AC</sub> = 265 V
ESD immunity (EN61000-4-2)	Level 4 (±8 kV) contact discharge
Surge immunity (EN61000-4-5)	Installation class 3 (2 kV: common mode)
Form factor case size (L x W x H)	(47 x 31 x 16) mm <sup>3</sup>

## 4 Circuit description

### 4.1 Mains input rectification and filtering

The AC line input side comprises the input fuse F1 as over-current protection. A rectified DC voltage (120 V ~ 374 V) is obtained through a bridge rectifier BR1 and a pi filter C13, FB21 and C22. The pi filter also attenuates the differential mode conducted EMI.

### 4.2 PWM control and switching MOSFET

The PWM pulse is generated by the Quasi Resonant PWM current-mode Controller **ICE2QS03G** and this PWM pulse drives the high voltage power CoolMOS™, **IPL65R1K5C6S (C6)** which designed according to the revolutionary Superjunction (SJ) principle. The CoolMOS™ C6 provides all benefits of a fast switching SJ MOSFET while not sacrificing ease of use. It achieves extremely low conduction and switching losses and can make switching applications more efficient, more compact, lighter and cooler. The PWM switch-on is determined by the zero-crossing input signal and the value of the up/down counter. The PWM switch-off is determined by the feedback signal  $V_{FB}$  and the current sensing signal  $V_{CS}$ . **ICE2QS03G** also performs all necessary protection functions in flyback converters. Details about the information mentioned above are illustrated in the product datasheet.

### 4.3 Snubber network

A snubber network DZD11 dissipates the energy of the leakage inductance and suppress ringing on the SMPS transformer.

### 4.4 Output stage

On the secondary side, 5 V output, the PWM pulse is generated by synchronous rectification controller **UCC24610**. The synchronous rectification pulse drives the logic level medium voltage power OptiMOS™, **BSC067N06LS3 G** which is optimized for synchronous rectification such as the lowest  $R_{DS(on)}$ , the perfect switching behavior of fast switching, the smallest footprint and highest power density. The capacitors C22 provides energy buffering following with the LC filter FB21 and C24 to reduce the output ripple and prevent interference between SMPS switching frequency and line frequency considerably. Storage capacitor C22 is designed to have an internal resistance (ESR) as small as possible. This is to minimize the output voltage ripple caused by the triangular current.

### 4.5 Feedback loop

For feedback, the output is sensed by the voltage divider of R26 and R25 and compared to TL431 internal reference voltage. C25, C26 and R24 comprise the compensation network. The output voltage of TL431 is converted to the current signal via optocoupler IC12 and two resistors R22 and R23 for regulation control.

## 5 Circuit operation

### 5.1 Startup operation

Since there is a built-in startup cell in the **ICE2QS03G**, there is no need for external start up resistor, which can improve standby performance significantly. When  $V_{CC}$  reaches the turn on voltage threshold 18V, the IC begins with a soft start. The soft-start implemented in **ICE2QS03G** is a digital time-based function. The preset soft-start time is 12 ms with 4 steps. If not limited by other functions, the peak voltage on CS pin will increase step by step from 0.32 V to 1 V finally. After IC turns on, the  $V_{CC}$  voltage is supplied by auxiliary windings of the transformer.

### 5.2 Normal mode operation

The secondary output voltage is built up after startup. The secondary regulation control is adopted with TL431 and optocoupler. The compensation network C25, C26 and R24 constitutes the external circuitry of the error amplifier of TL431. This circuitry allows the feedback to be precisely controlled with respect to dynamically varying load conditions, therefore providing stable control.

### 5.3 Primary side peak current control

The MOSFET drain source current is sensed via external resistor R14 and R14A. Since **ICE2QS03G** is a current mode controller, it would have a cycle-by-cycle primary current and feedback voltage control which can make sure the maximum power of the converter is controlled in every switching cycle.

### 5.4 Digital frequency reduction

During normal operation, the switching frequency for **ICE2QS03G** is digitally reduced with decreasing load. At light load, the CoolMOS™ **IPL65R1K5C6S** will be turned on not at the first minimum drain-source voltage time, but on the  $n^{\text{th}}$ . The counter is in range of 1 to 7, which depends on feedback voltage in a time-base. The feedback voltage decreases when the output power requirement decreases, and vice versa. Therefore, the counter is set by monitoring voltage  $V_{FB}$ . The counter will be increased with low  $V_{FB}$  and decreased with high  $V_{FB}$ . The thresholds are preset inside the IC.

### 5.5 Burst mode operation

At light load condition, the SMPS enters into Active Burst Mode. At this stage, the controller is always active but the  $V_{CC}$  must be kept above the switch off threshold. During active burst mode, the efficiency increase significantly and at the same time it supports low ripple on  $V_{out}$  and fast response on load jump.

For determination of entering Active Burst Mode operation, three conditions apply:

1. The feedback voltage is lower than the threshold of  $V_{FBEB}$  (1.25 V). Accordingly, the peak current sense voltage across the shunt resistor is 0.1667;
2. The up/down counter is 7;
3. And a certain blanking time ( $t_{BEB}=24$  ms).

Once all of these conditions are fulfilled, the Active Burst Mode flip-flop is set and the controller enters Active Burst Mode operation. This multi-condition determination for entering Active Burst Mode operation prevents mis-triggering of entering Active Burst Mode operation, so that the controller enters Active Burst Mode operation only when the output power is really low during the preset blanking time.

## Protection features

During active burst mode, the maximum current sense voltage is reduced from 1 V to 0.34 V so as to reduce the conduction loss and the audible noise. At the burst mode, the FB voltage is changing like a sawtooth between 3.0 and 3.6 V.

The feedback voltage immediately increases if there is a high load jump. This is observed by one comparator. As the current limit is 34% during Active Burst Mode a certain load is needed so that feedback voltage can exceed  $V_{FBLB}$  (4.5 V). After leaving active burst mode, maximum current can now be provided to stabilize  $V_{out}$ . In addition, the up/down counter will be set to 1 immediately after leaving Active Burst Mode. This is helpful to decrease the output voltage undershoot.

## 6 Protection features

### 6.1 $V_{CC}$ over voltage and under voltage protection

During normal operation, the  $V_{CC}$  voltage is continuously monitored. When the  $V_{CC}$  voltage increases up to  $V_{CC,OVP}$  or  $V_{CC}$  voltage falls below the under voltage lock out level  $V_{CC,off}$ , the IC will enter into autorestart mode.

### 6.2 Over load/Open loop protection

In case of open control loop, feedback voltage is pulled up with internally block. After a fixed blanking time, the IC enters into auto restart mode. In case of secondary short-circuit or overload, regulation voltage  $V_{FB}$  will also be pulled up, same protection is applied and IC will auto restart.

### 6.3 Auto restart for over temperature protection

The IC has a built-in over temperature protection function. When the controller's temperature reaches 140°C, the IC will shut down switch and enters into auto restart. This can protect power MOSFET from overheated.

### 6.4 Adjustable output overvoltage protection

During off-time of the power switch, the voltage at the zero-crossing pin ZC is monitored for output overvoltage detection. If the voltage is higher than the preset threshold 3.7 V for a preset period 100  $\mu$ s, the IC is latched off.

### 6.5 Short winding protection

The source current of the MOSFET is sensed via external resistor R14 and R14A. If the voltage at the current sensing pin is higher than the preset threshold  $V_{CSSW}$  of 1.68 V during the on-time of the power switch, the IC is latched off. This constitutes a short winding protection. To avoid an accidental latch off, a spike blanking time of 190 ns is integrated in the output of internal comparator.



## **6.6 Foldback point protection**

For a quasi-resonant flyback converter, the maximum possible output power is increased when a constant current limit value is used for all the mains input voltage range. This is usually not desired as this will increase additional cost on transformer and output diode in case of output over power conditions. The internal foldback protection is implemented to adjust the  $V_{CS}$  voltage limit according to the bus voltage. Here, the input line voltage is sensed using the current flowing out of ZC pin, during the MOSFET on-time. As the result, the maximum current limit will be lower at high input voltage and the maximum output power can be well limited versus the input voltage.



Circuit diagram

# 7 Circuit diagram

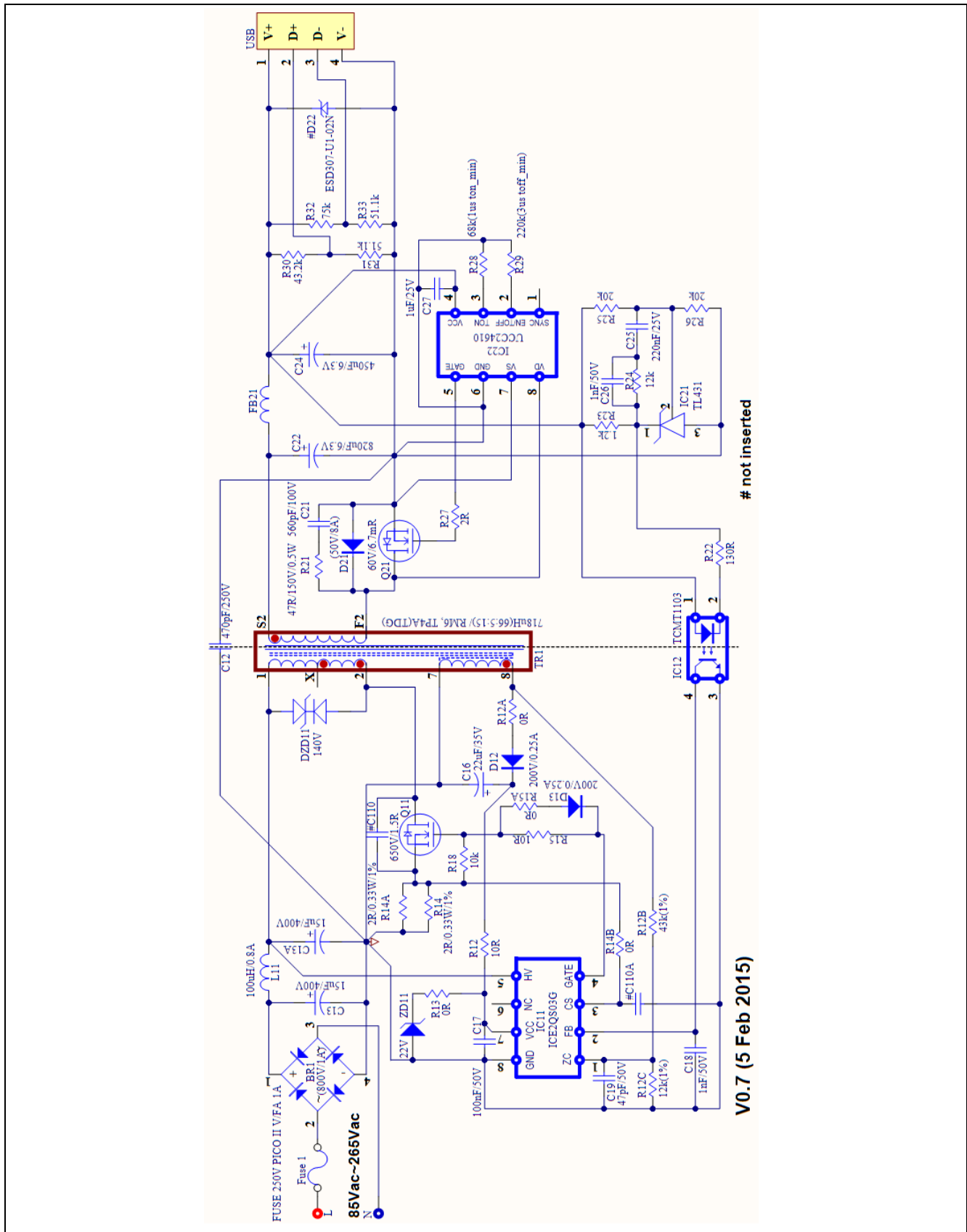

Figure 3 Schematic of REF-15W\_C61K5-THINPAK ADAPTER

PCB layout

## 8 PCB layout

### 8.1 Top side

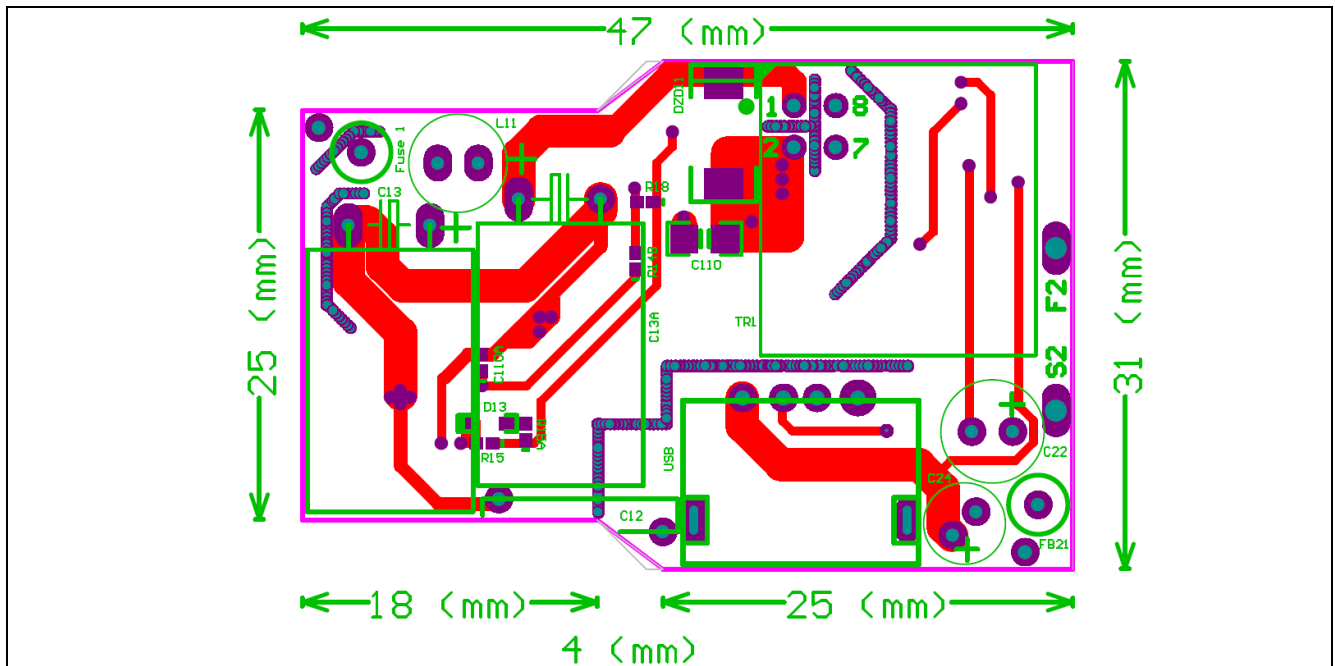

Figure 4 Top side copper and component legend

### 8.2 Bottom side

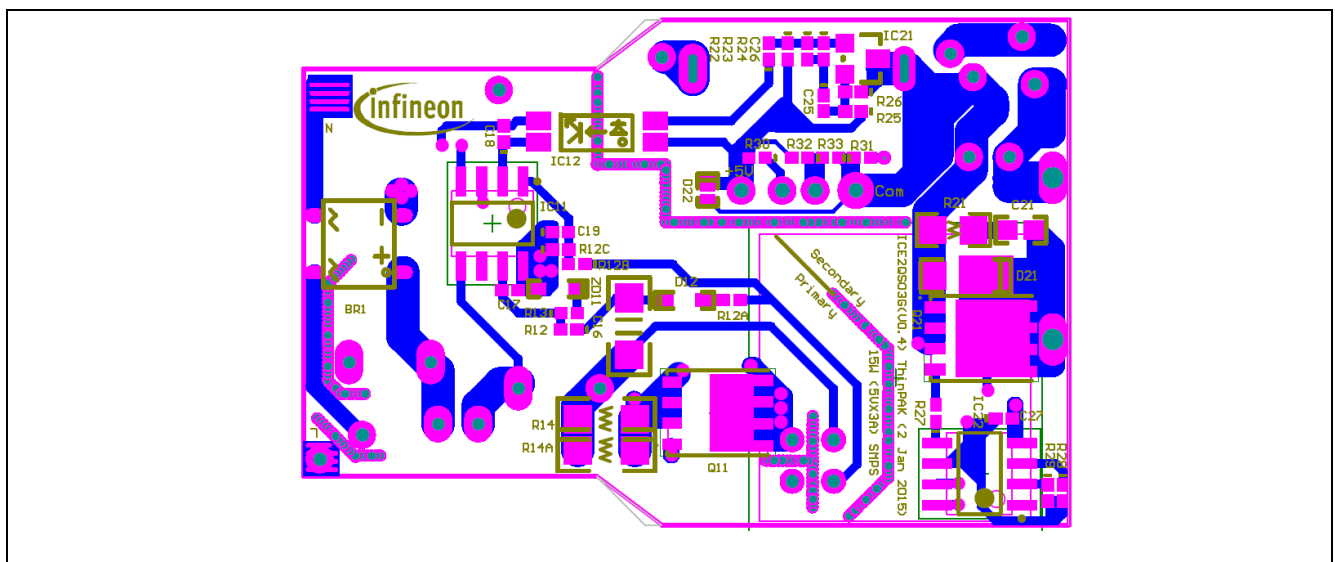

Figure 5 Bottom side copper and component legend

**Component list**

## 9 Component list

**Table 2 Bill of materials(V0.7)**

No.	Designator	Description	Footprint	Part Number	Manufacturer	Quantity
1	BR1	(800V/1A)	SOP-4	D1UBA80	SHINDENGEN	1
2	C12	470pF/250V	MKT3/13/10_0M8	DE1B3KL471KC4BNA1S	MURATA	1
3	C13, C13A	15uF/400V	RB10H(10x16)	400AX15M10X16	RUBYCON	2
4	C16	22uF/35V	1206	C3216X5R1V226M	TDK	1
5	C17	100nF/50V	0402	GRM155R71H104KE14D	MURATA	1
6	C18, C26	1nF/50V	0402	GRM155R71H102KA01D	MURATA	2
7	C19	47pF/50V	0402	GRM1555C1H470JA01D	MURATA	1
8	C21	560pF/100V	0603	GRM1885C2A561JA01D	MURATA	1
9	C22	820uF/6.3V	RB6.3	MP6RL820MC8	MATSUKI POLYMER	1
10	C24	450uF/6.3V	RB5	MP6RL450MB8	MATSUKI POLYMER	1
11	C25	220nF/25V	0402	GRM155C81E224KE01D	MURATA	1
12	C27	1uF/25V	0402	GRM155R61E105KA12D	MURATA	1
13	D12,D13	200V/0.25A	SOD323	BAS21-03W	INFINEON	2
14	D21	50V/8A	DO-221BC(SMPA)	V8PAN50-M3/I		1
15	DZD11	140V	2F	ST02D-140F2	SHINDENGEN	1
16	F1	250V/1A	AXIAL0.4_V 3mm	0263001.HAT1L		1
17	FB21	FAIR RITE	AXIAL0.4_V 3mm	2743002112		1
18	FB22,FB23	@ C12 lead		B64290P0035X038	EPCOS	2
19	IC11	ICE2QS03G	SO-8	ICE2QS03G	INFINEON	1
20	IC12	TCMT1103	half pitch mini flat	TCMT1103		1
21	IC21	TL431	SOT-23	TL431BFDT		1
22	IC22	UCC24610	SO-8	UCC24610		1
23	L11	100uH/0.8A	CH6	7447462101	WURTH ELECTRONICS	1
24	Q11	650V/1.5Ω	ThinPAK(5x6)	IPL65R1K5C6S	INFINEON	1
25	Q21	60V/6.7mΩ	PG-TDSON-8	BSC067N06LS3 G	INFINEON	1
26	R12, R15	10R	0402			2
27	R12A, R13, R14B, R15A	0R	0402			4
28	R12B	43k/1%	0402			1
29	R12C	12k/1%	0402			1
30	R14, R14A	2R/0.33W/1%	1206	ERJ8BQF2R0V		2
31	R18	10k	0402			1
32	R21	47R/0.5W	0805	ERJP6WF47R0V		1
33	R22	130R	0402			1
34	R23	1.2k	0402			1
35	R24	12k	0402			1
36	R25, R26	20k	0402			2
37	R27	2R	0402			1
38	R28	68k	0402			1
39	R29	220k	0402			1
40	R30	43.2k	0402			1
41	R31, R33	51.1k	0402			1
42	R32	75k	0402			1
43	TR1	718uH(66:5:15)	TR_RM6_THT8Pin			1
44	USB Port	USBPORT	USB2 Short	JL-CAF-001		1
45	ZD11	22V Zener	SOD323	UDZS22B		1

Transformer construction

# 10 Transformer construction

Core and material: RM6 TP4A

Bobbin: RM6 with 4 pin

Primary Inductance,  $L_p=718 \mu\text{H}$  ( $\pm 10\%$ ), measured between pin 2 and pin 1

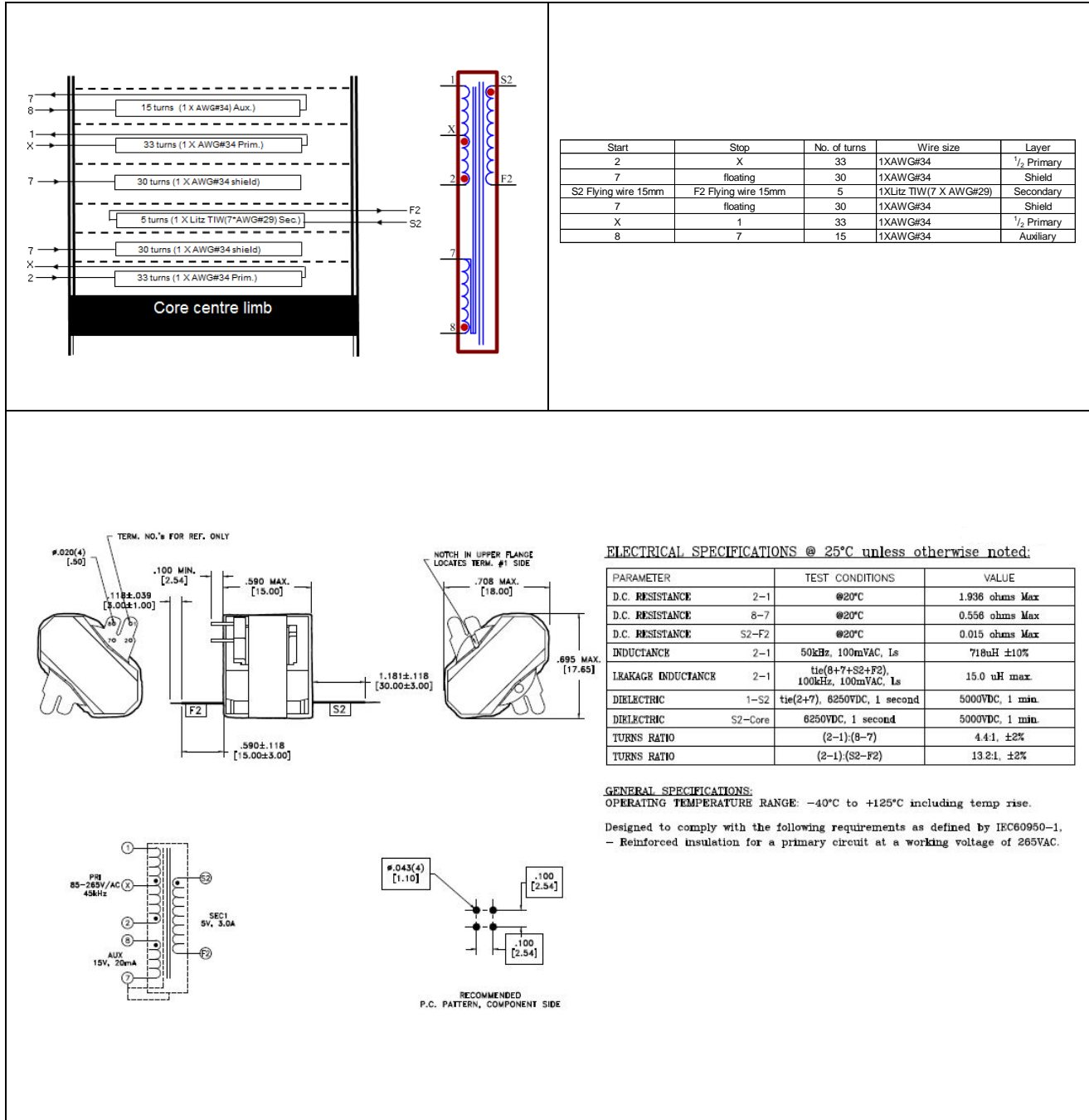

Figure 6 Transformer structure

Test results

# 11 Test results

## 11.1 Efficiency, regulations and output ripple

**Table 3 Efficiency, regulation & output ripple**

V <sub>in</sub> (V <sub>AC</sub> )	P <sub>in</sub> (W)	V <sub>out</sub> (V <sub>DC</sub> )	I <sub>out</sub> (A)	V <sub>out_ripple_pk_pk</sub> (mV)	P <sub>out</sub> (W)	Efficiency(η) (%)	Average η (%)	OLP P <sub>in</sub> (W)	OLP I <sub>out</sub> (A)
85	0.0307	5.01	0.00	58.90				20.60	3.52
	1.7000	5.01	0.30	68.20	1.50	88.41			
	4.2000	5.01	0.75	24.12	3.76	89.46			
	8.4300	5.01	1.50	31.50	7.52	89.15	88.65		
	12.6800	5.01	2.25	35.80	11.27	88.90			
	17.2600	5.01	3.00	49.50	15.03	87.08			
115	0.0310	5.01	0.00	62.50				20.37	3.60
	1.7100	5.01	0.30	72.00	1.50	87.89			
	4.2000	5.01	0.75	23.60	3.76	89.46			
	8.3700	5.01	1.50	32.00	7.52	89.78	89.58		
	12.5500	5.01	2.25	31.90	11.27	89.82			
	16.8400	5.01	3.00	40.80	15.03	89.25			
230	0.0334	5.01	0.00	67.90				21.01	3.73
	1.7500	5.01	0.30	70.80	1.50	85.89			
	4.3700	5.01	0.75	22.00	3.76	85.98			
	8.4900	5.01	1.50	32.00	7.52	88.52	87.91		
	12.6500	5.01	2.25	31.80	11.27	89.11			
	17.0700	5.01	3.00	37.70	15.03	88.05			
265	0.0353	5.01	0.00	72.00				21.39	3.76
	1.7700	5.01	0.30	79.30	1.50	84.92			
	4.4600	5.01	0.75	22.90	3.76	84.25			
	8.5600	5.01	1.50	31.70	7.52	87.79	86.91		
	12.7400	5.01	2.25	34.50	11.27	88.48			
	17.2500	5.01	3.00	42.10	15.03	87.13			

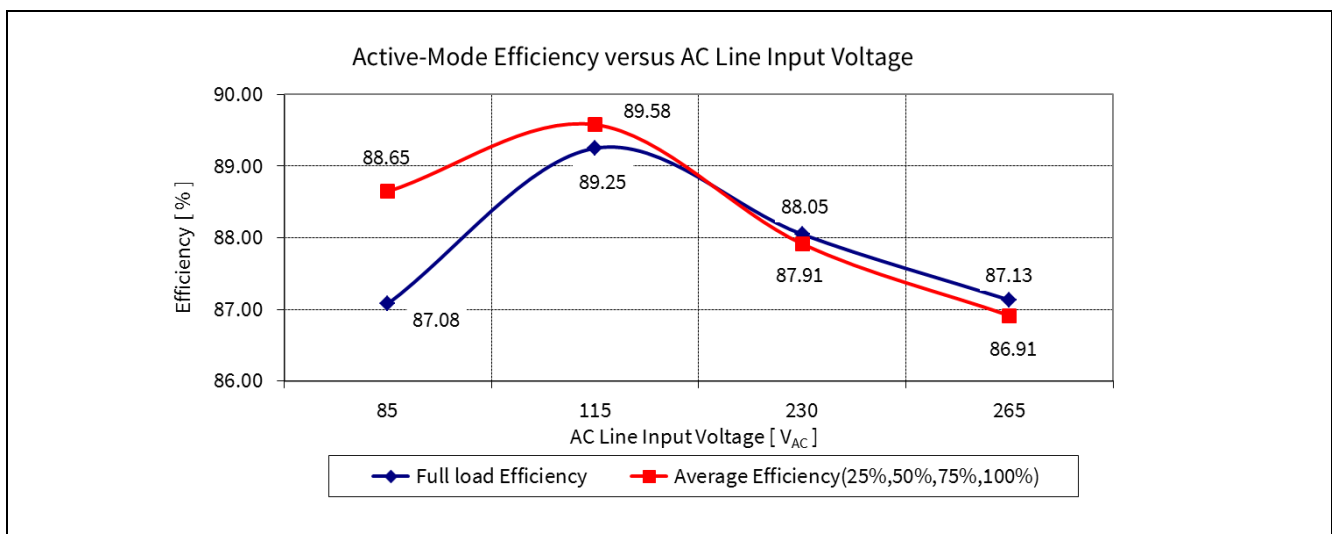

**Figure 7 Efficiency vs AC line input voltage**

Test results

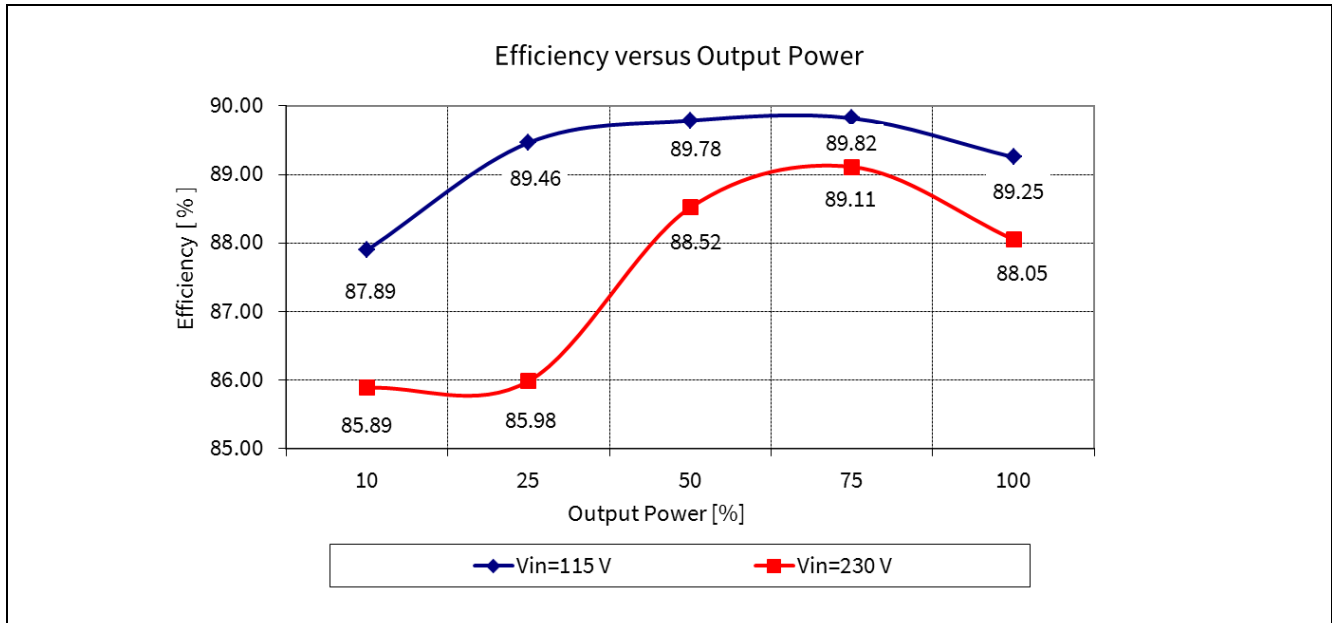

Figure 8 Efficiency vs output power @ 115 V<sub>AC</sub> and 230 V<sub>AC</sub> line

### 11.2 Standby power

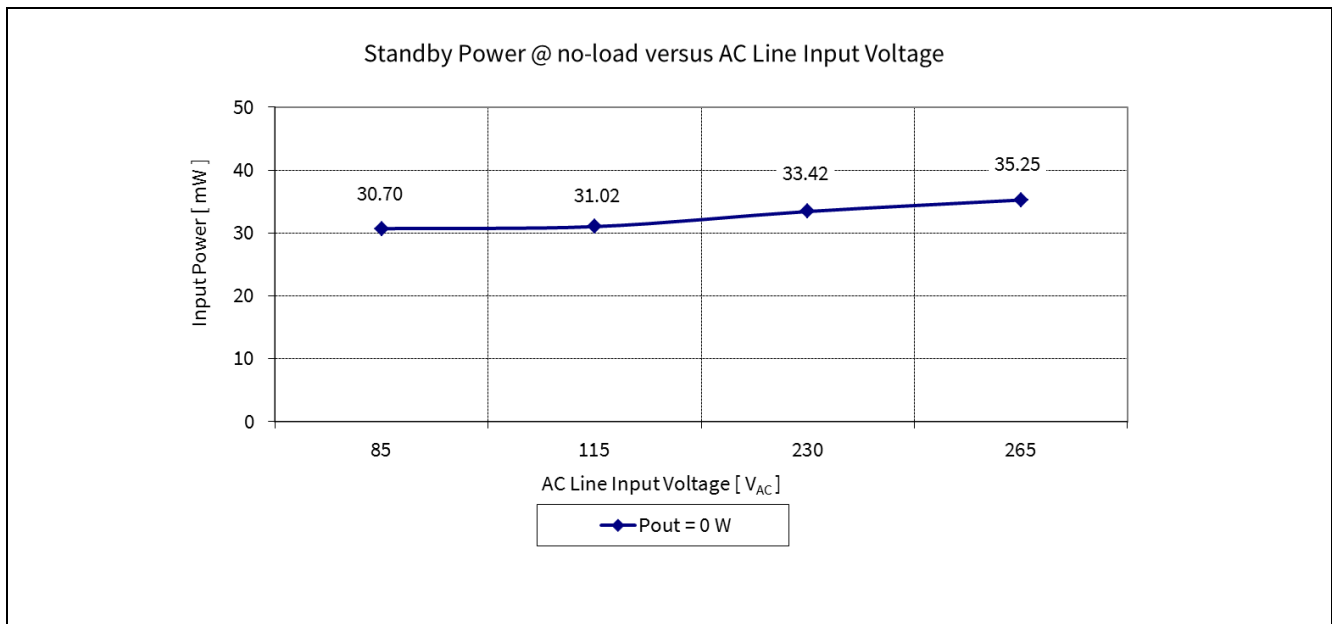

Figure 9 Standby power @ no load vs AC line input voltage (measured by Yokogawa WT210 power meter - integration mode)

Test results

### 11.3 Line regulation

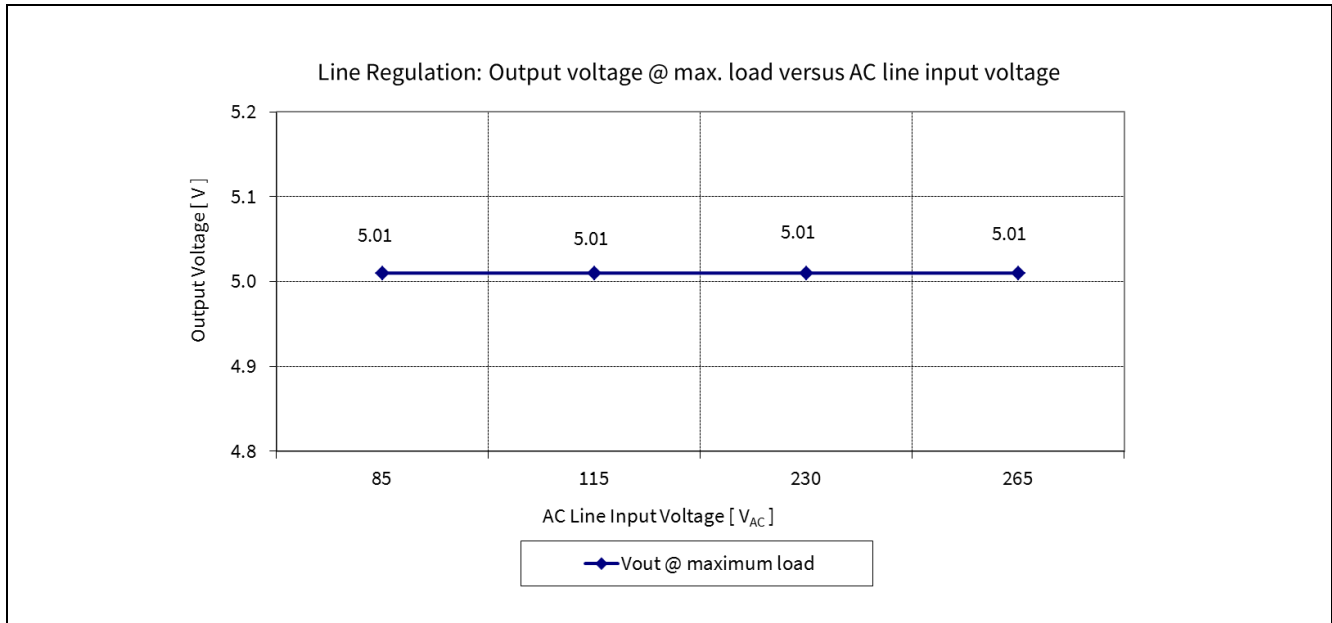

Figure 10 Line regulation  $V_{out}$  @ full load vs AC line input voltage

### 11.4 Load regulation

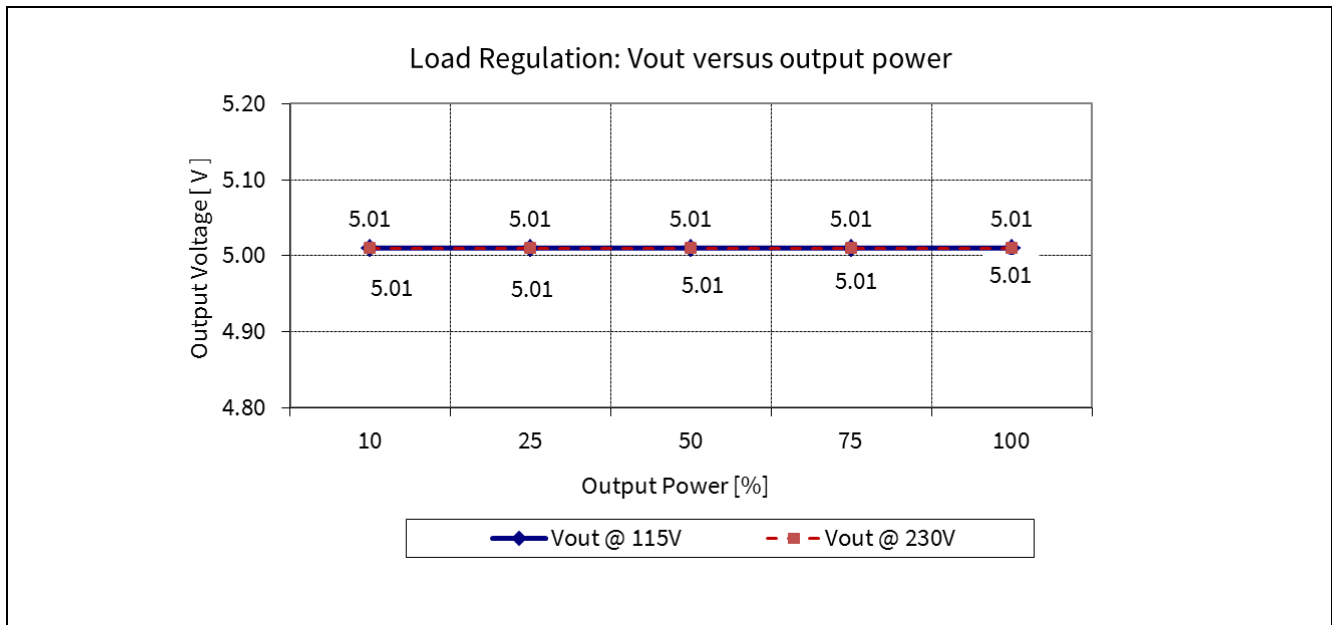

Figure 11 Load regulation  $V_{out}$  vs output power



Test results

11.5 Maximum power

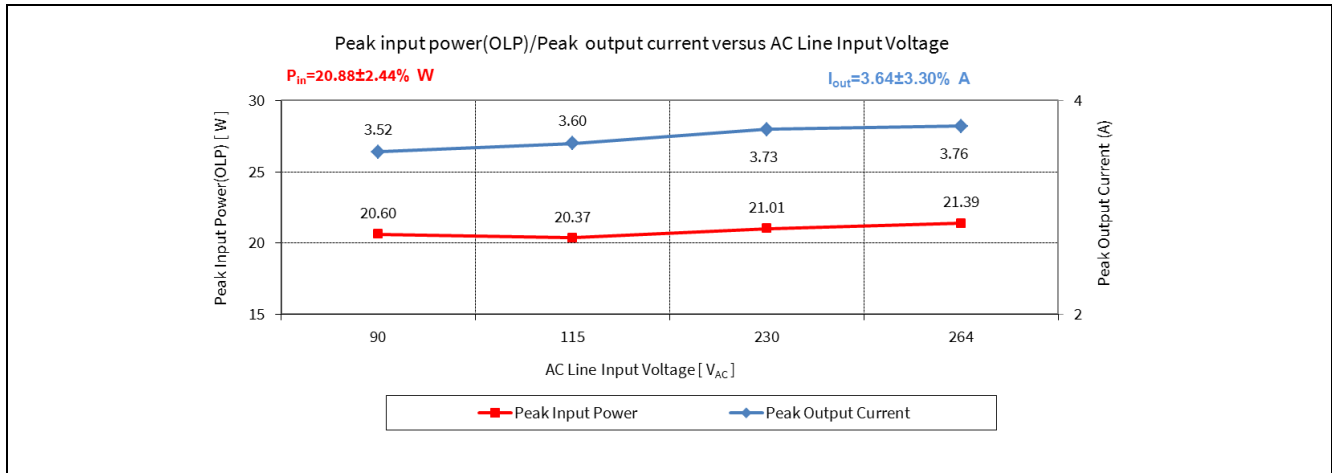

Figure 12 Maximum input power (before over-load protection) vs AC line input voltage

11.6 ESD immunity (EN61000-4-2)

Pass EN61000-4-2 level 3 (±8 kV) contact discharge.

11.7 Surge immunity (EN61000-4-5)

Pass EN61000-4-5 Installation class 3 (2 kV: common mode).

Test results

11.8 Conducted emissions (EN55022 class B)

The conducted EMI was measured by Schaffner (SMR25503) and followed the test standard of EN55022 (CISPR 22) class B. The demo board was set up at maximum load (15 W) with input voltage of 115 V<sub>AC</sub> and 230 V<sub>AC</sub>.

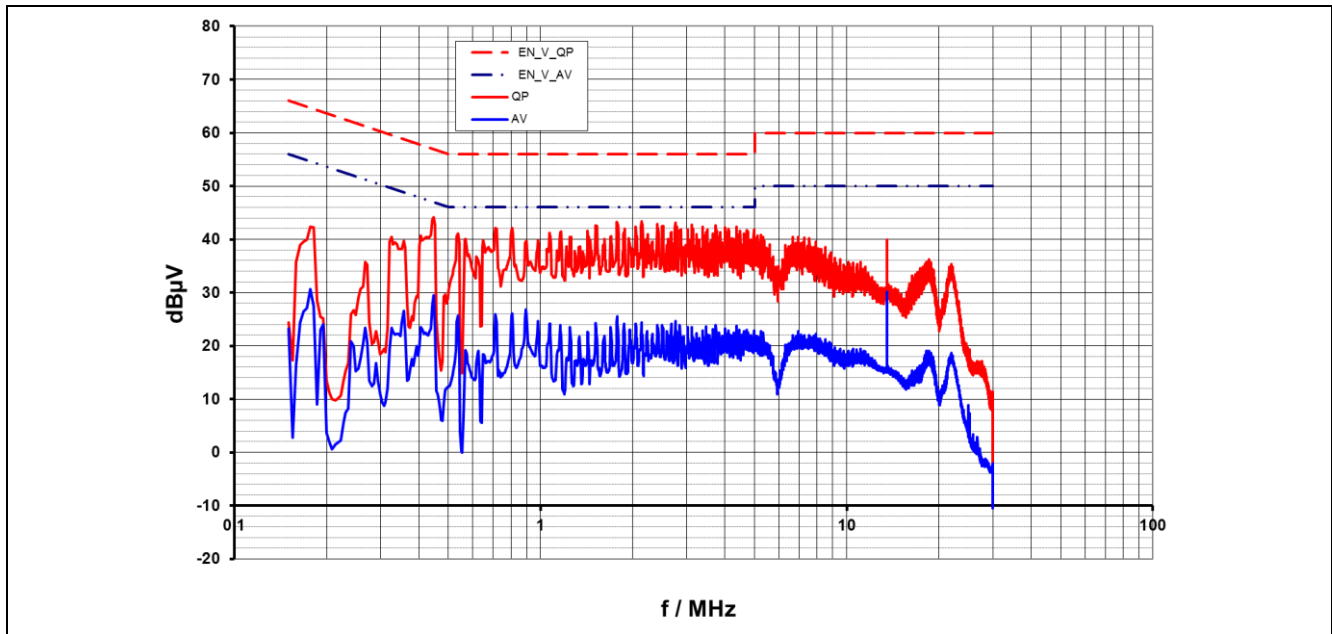

Figure 13 Conducted emissions(Line) at 115 V<sub>AC</sub> and maximum Load

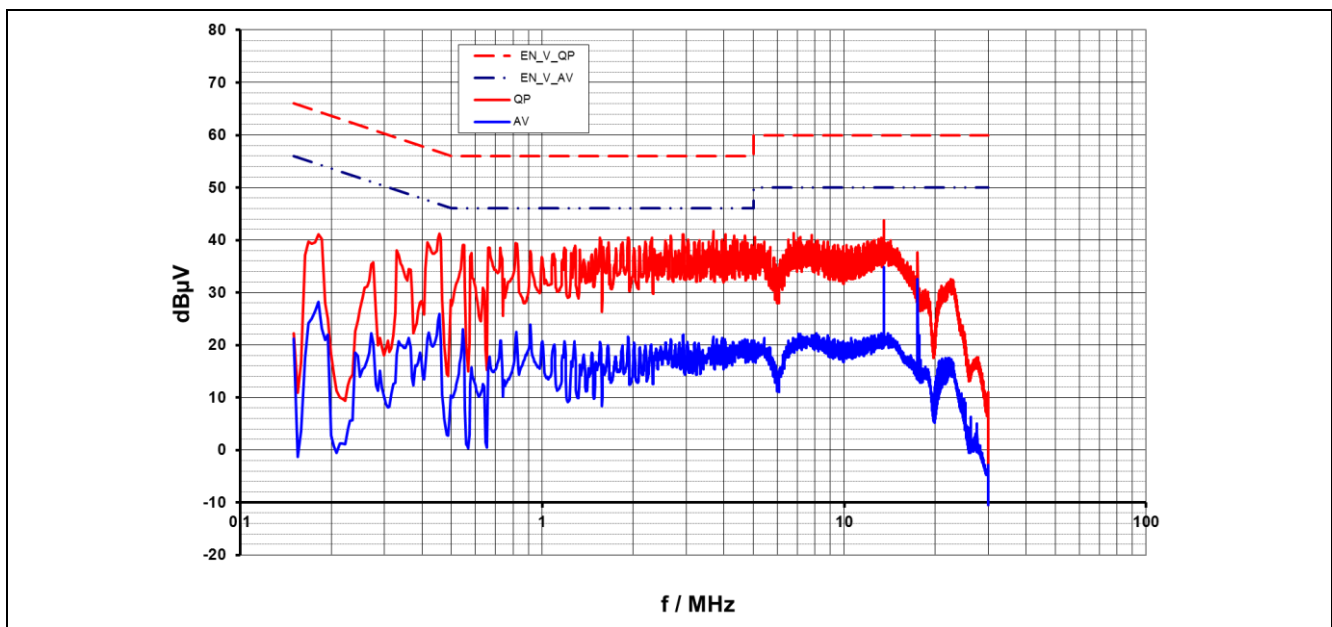

Figure 14 Conducted emissions(Neutral) at 115 V<sub>AC</sub> and maximum Load

Test results

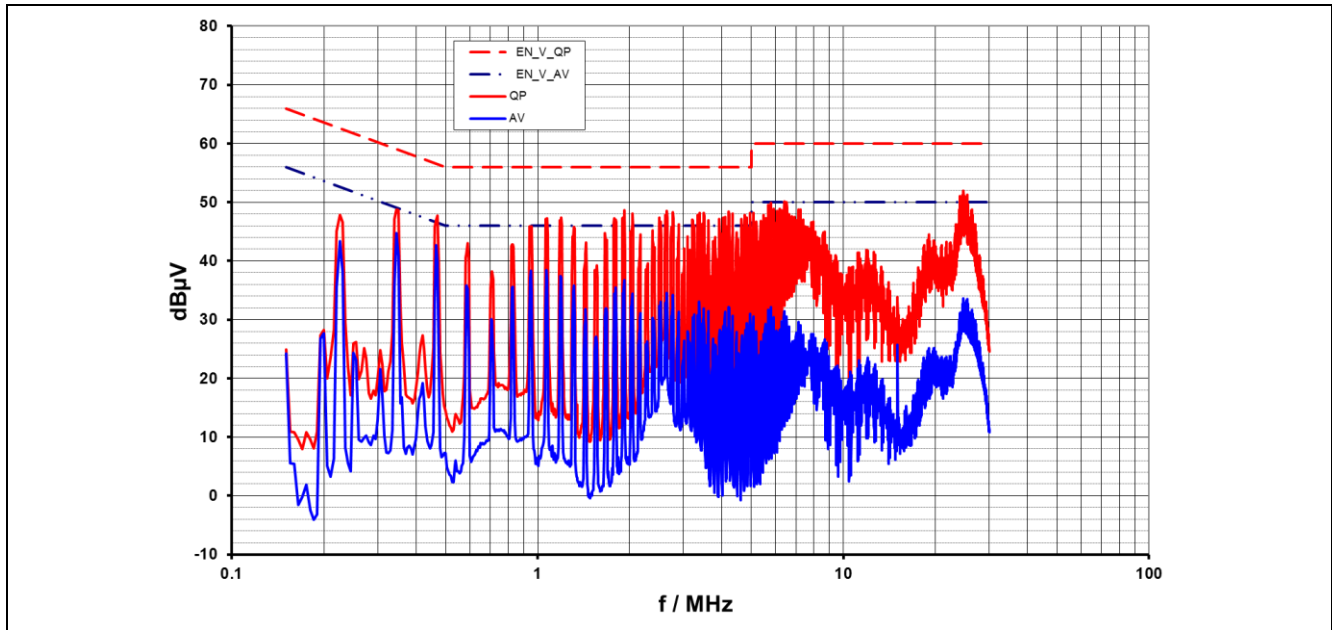

Figure 15 Conducted emissions(line) at 230 V<sub>AC</sub> and maximum Load

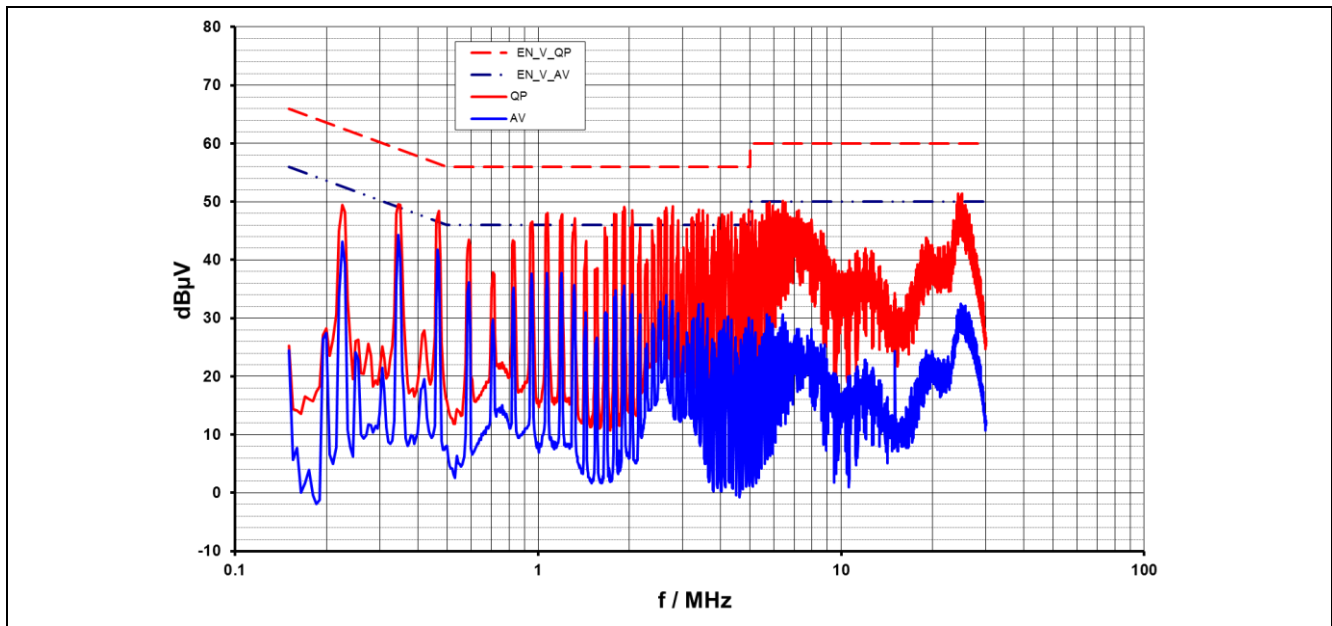

Figure 16 Conducted emissions(Neutral) at 230 V<sub>AC</sub> and maximum Load

Pass conducted EMI EN55022 (CISPR 22) class B with > 8 dB margin for QP.

**Test results**

**11.9 Thermal measurement**

The reference adapter's open frame thermal test was done by thermal infrared camera (TVS-500EX) at the ambient temperature 25 °C. The thermal measures were taken after two hours running with full load and the highest temperature of Q11 (CoolMOS™ C6 ThinPAK 5x6) is 75.6 °C for low line and 90.3 °C for high line.

**Table 4 Hottest temperature of reference board**

No.	Major component	85 V <sub>AC</sub> (°C)	265 V <sub>AC</sub> (°C)
1	Q11 (IPL65R1K5C6S)	75.6	90.3
2	Q21 (BSC067N06LS3 G)	55.3	68.8
3	IC22 (SR IC)	49.1	57.7
4	TR1 (Transformer)	59.2	63.7
5	IC11 (ICE2QS03G)	63.8	63.8
6	BR1 (bridge diode)	62.5	48.2
7	DZD11(Snubber zenor diode)	78.8	86.1
8	C13A (Bulk Cap)	52.5	48.6
9	L11 (Differnetial Choke)	54.3	46.7
10	Ambient	25	25

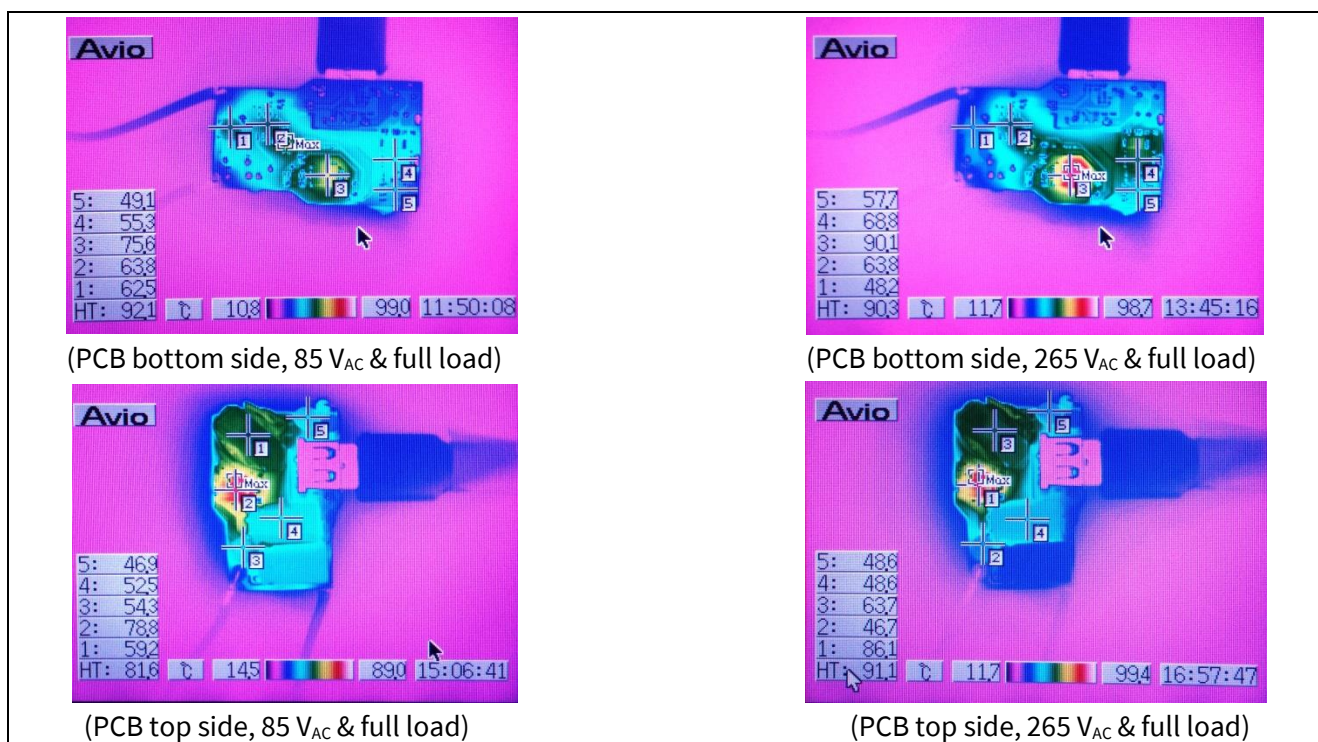

**Figure 17 Infrared thermal image of REF-15W\_C61K5-THINPAK ADAPTER**

Waveforms and scope plots

## 12 Waveforms and scope plots

All waveforms and scope plots were recorded with a LeCroy 6050 oscilloscope

### 12.1 Start up at low/high AC line input voltage with maximum load

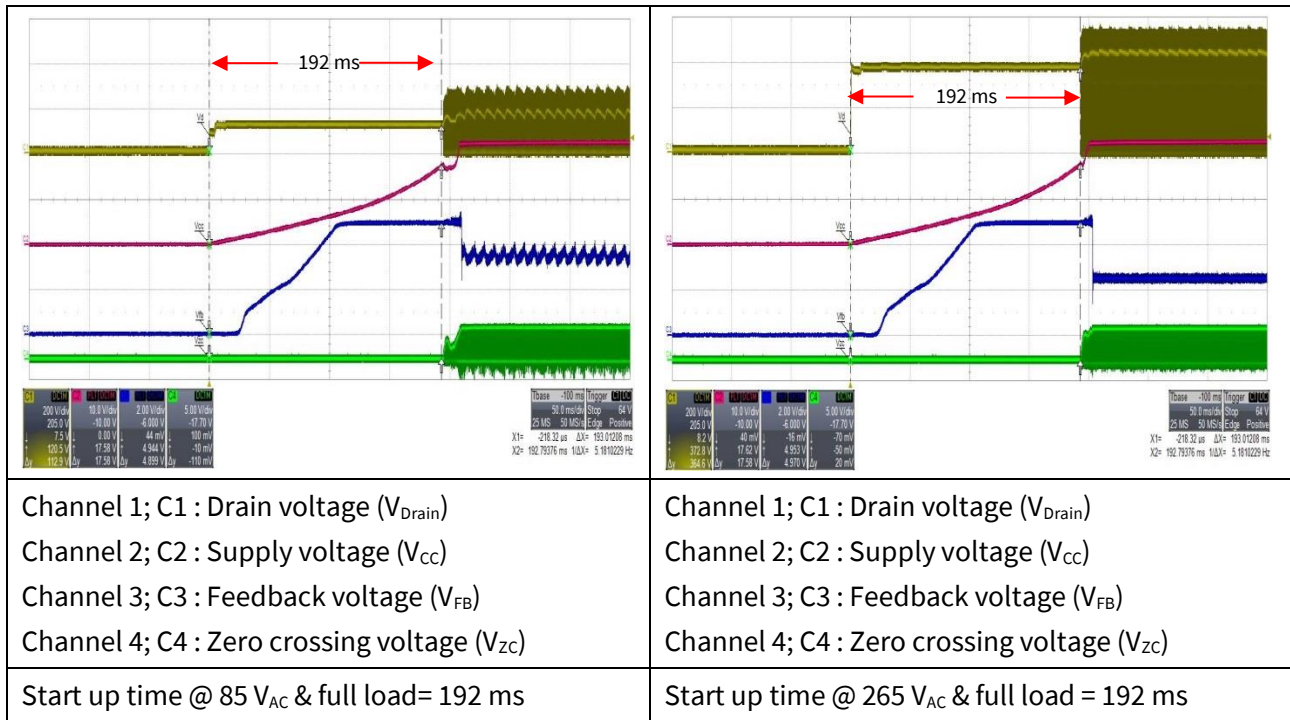

Figure 18 Start up

### 12.2 Soft start

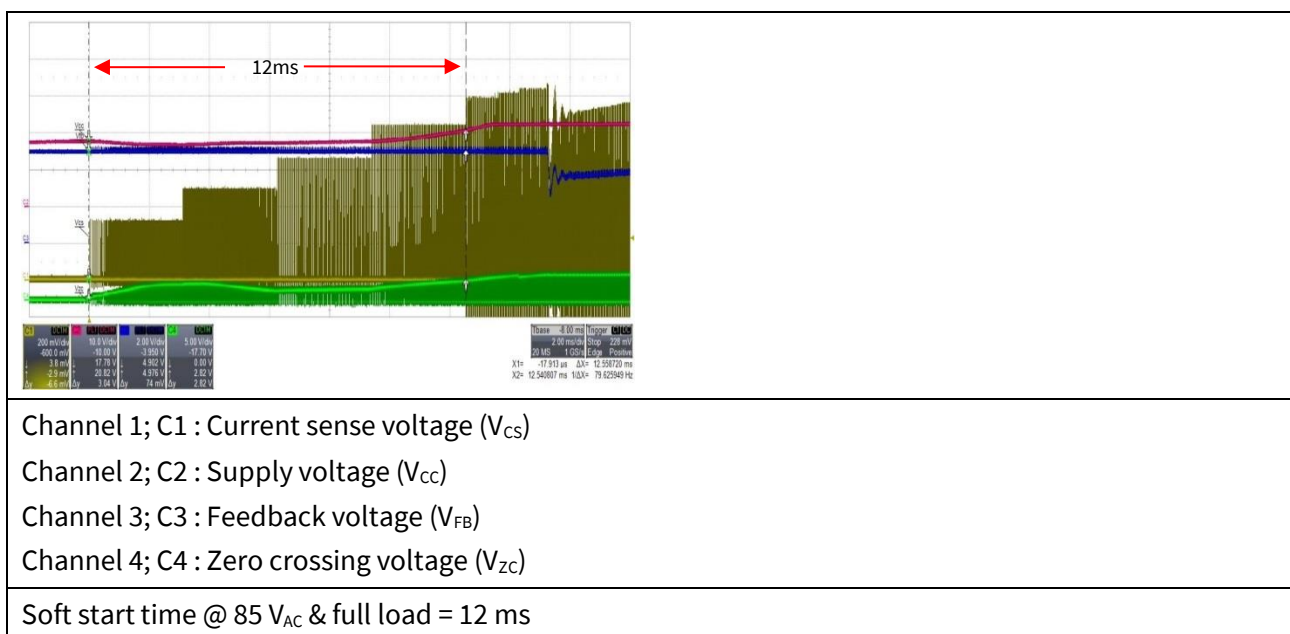

Figure 19 Soft start



Waveforms and scope plots

12.3 Start up delay time & output voltage rise time

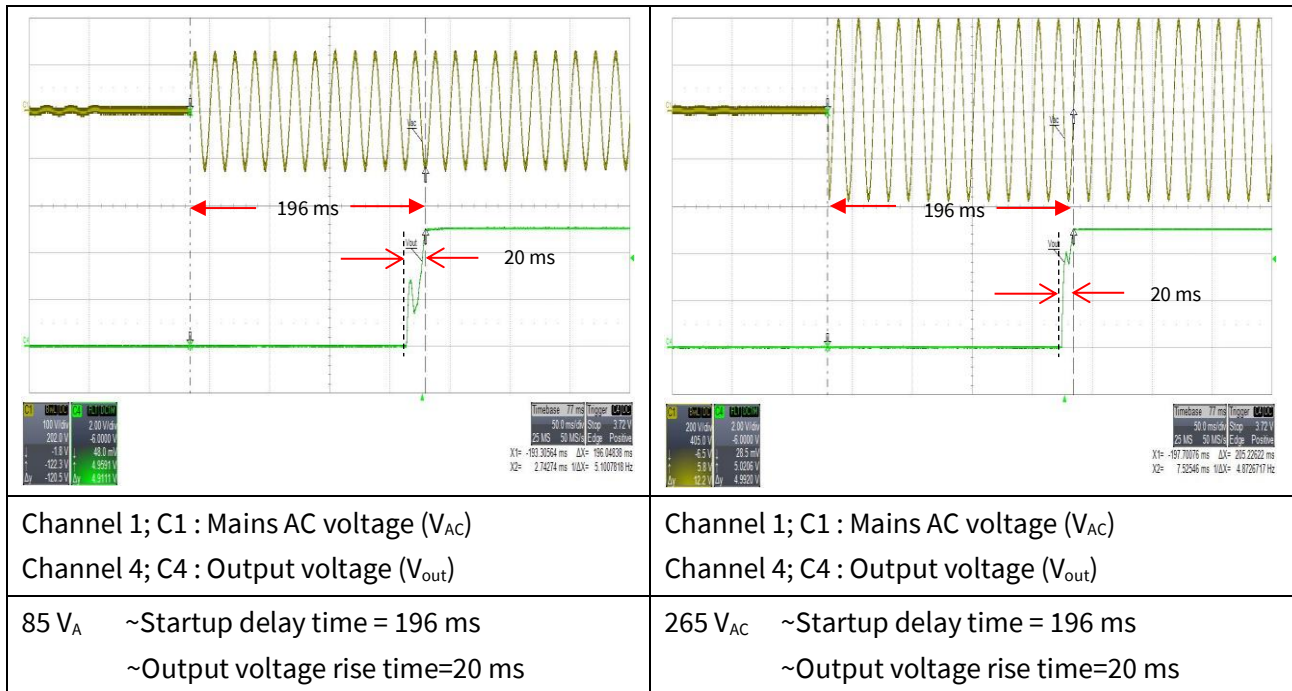

Figure 20 Start up delay time

12.4 Hold up time

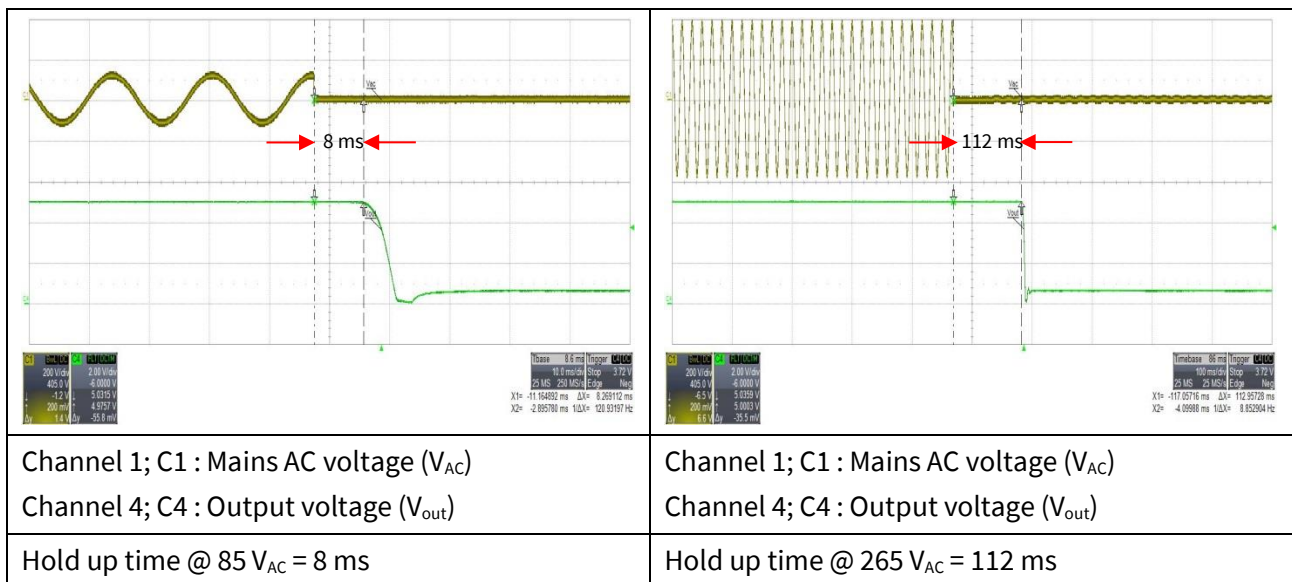

Figure 21 Hold up time

Waveforms and scope plots

12.5 Drain & current sense voltage at maximum load

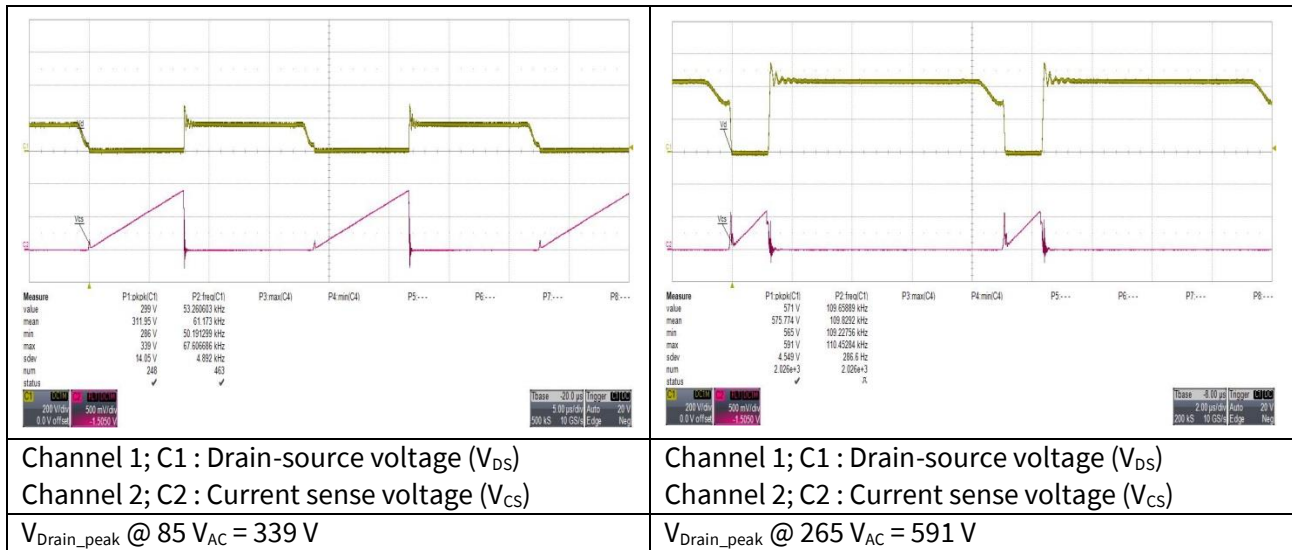

Figure 22 Drain & current sense voltage

12.6 Zero crossing point during normal operation

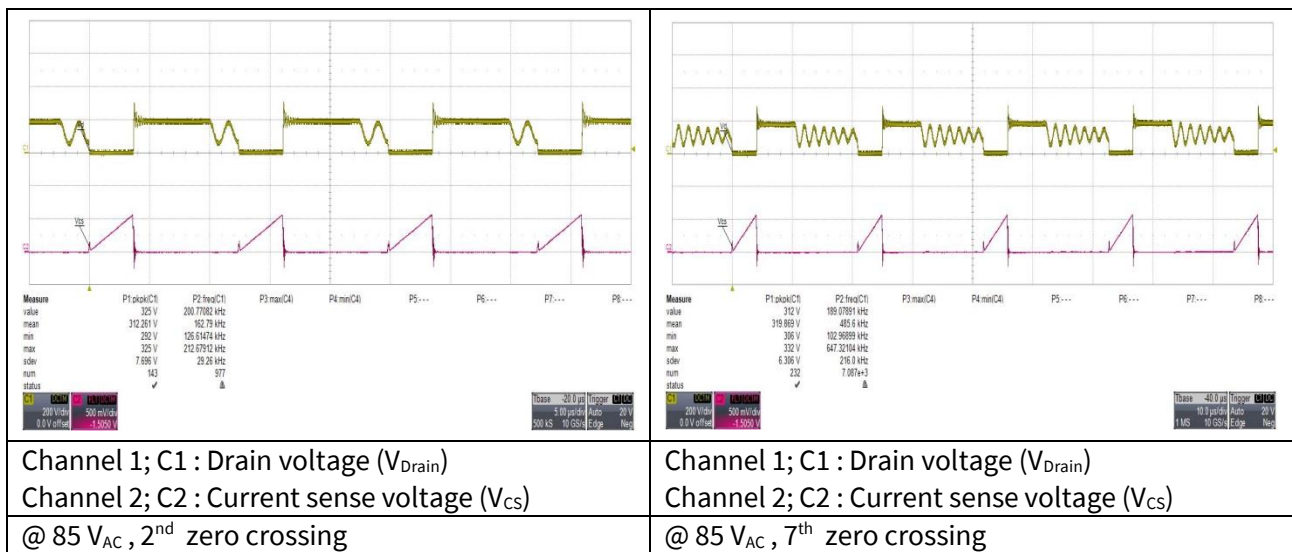

Figure 23 Zero crossing



Waveforms and scope plots

12.7 Load transient response (Dynamic load from 1.67% to 100%)

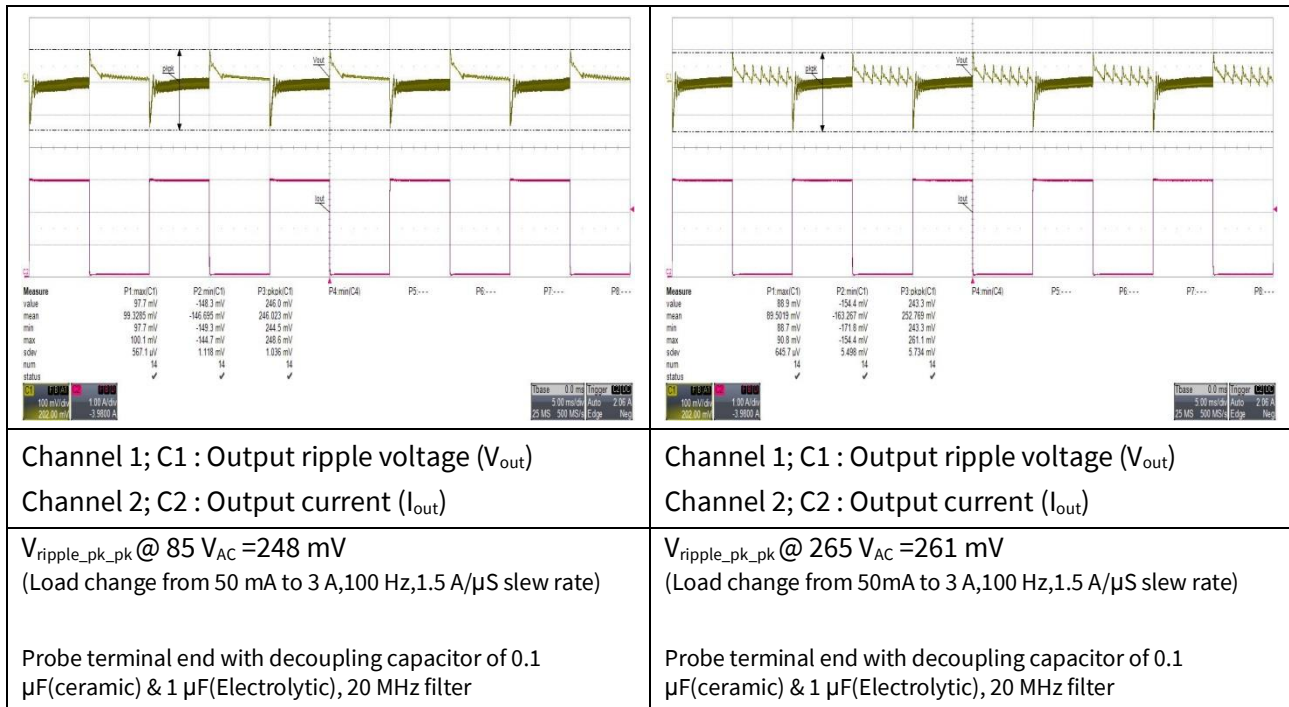

Figure 24 Load transient response

12.8 Output ripple voltage at maximum load

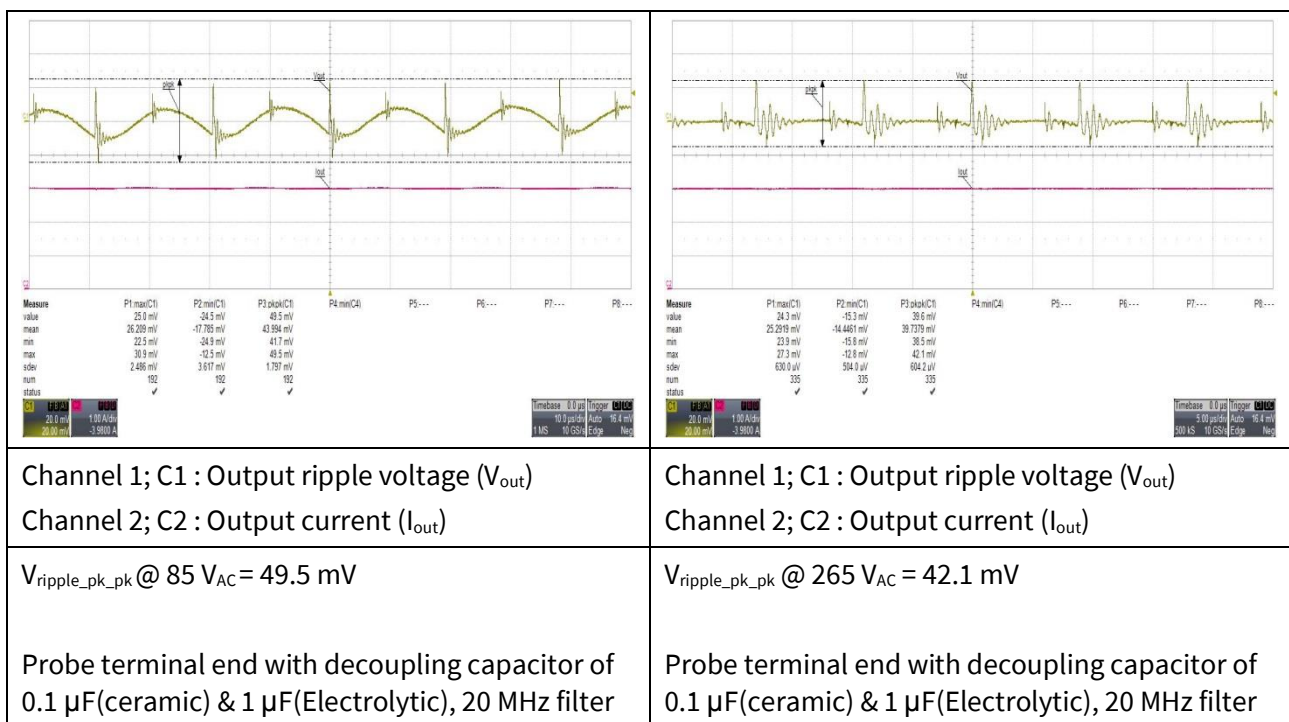

Figure 25 AC output ripple voltage at maximum load

Waveforms and scope plots

12.9 Output ripple voltage during burst mode at 1 W load

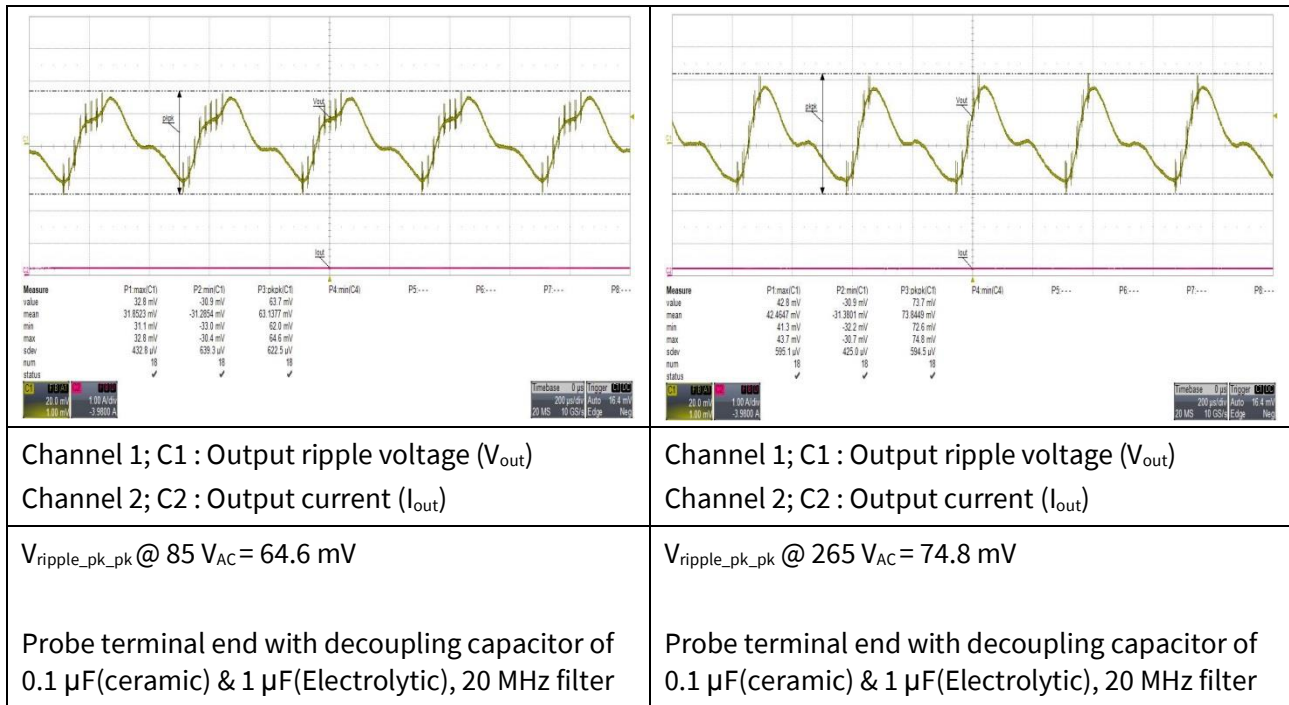

Figure 26 AC output ripple voltage at 1 W load(Burst Mode)

12.10 Active Burst mode operation

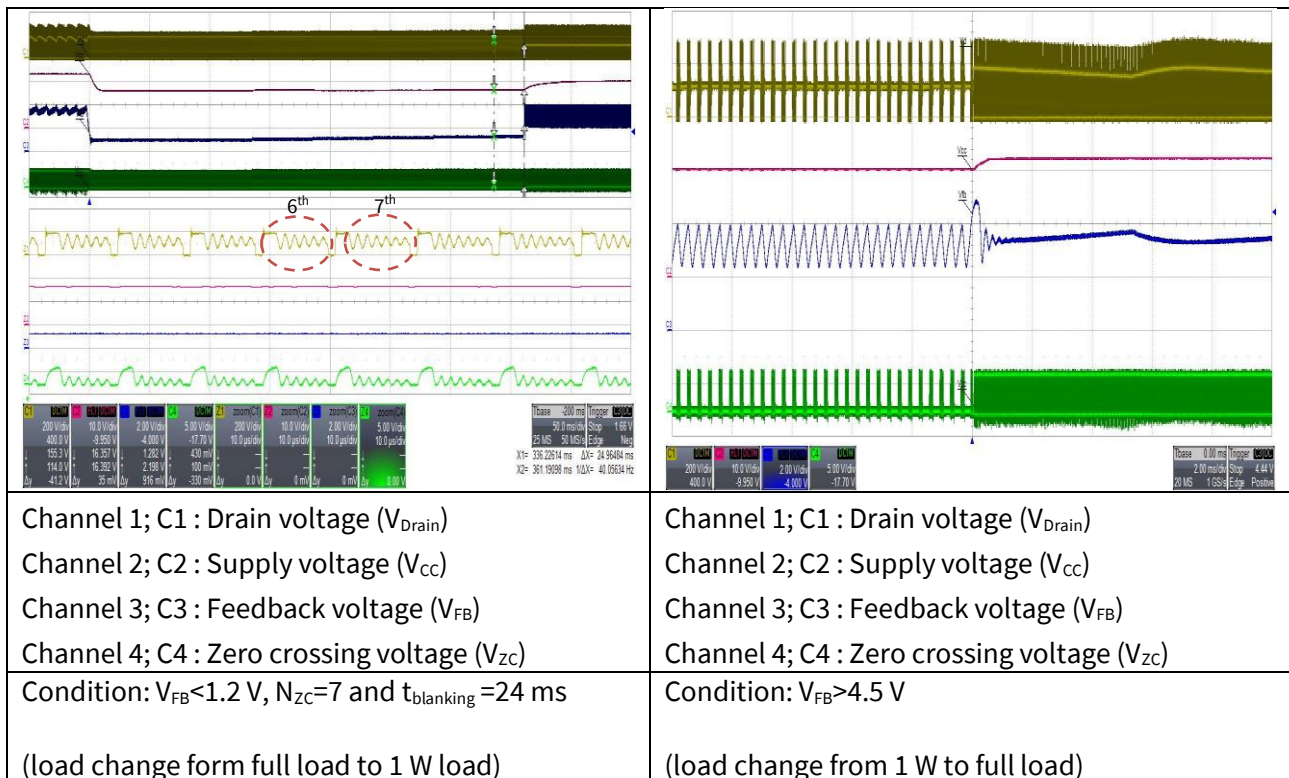

Figure 27 Active burst mode at 85  $V_{AC}$

Waveforms and scope plots

12.11 Over load protection (Auto restart mode)

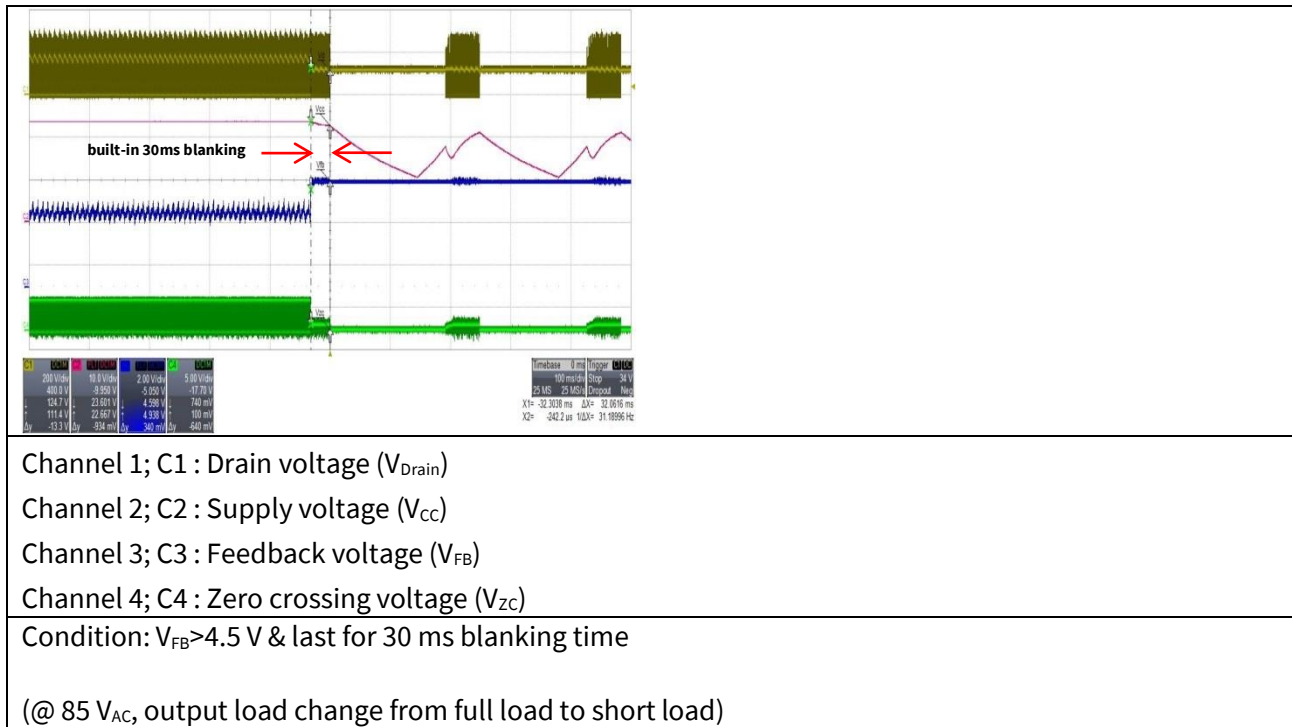

Figure 28 Over load protection

12.12 Output overvoltage protection (Latched off mode)

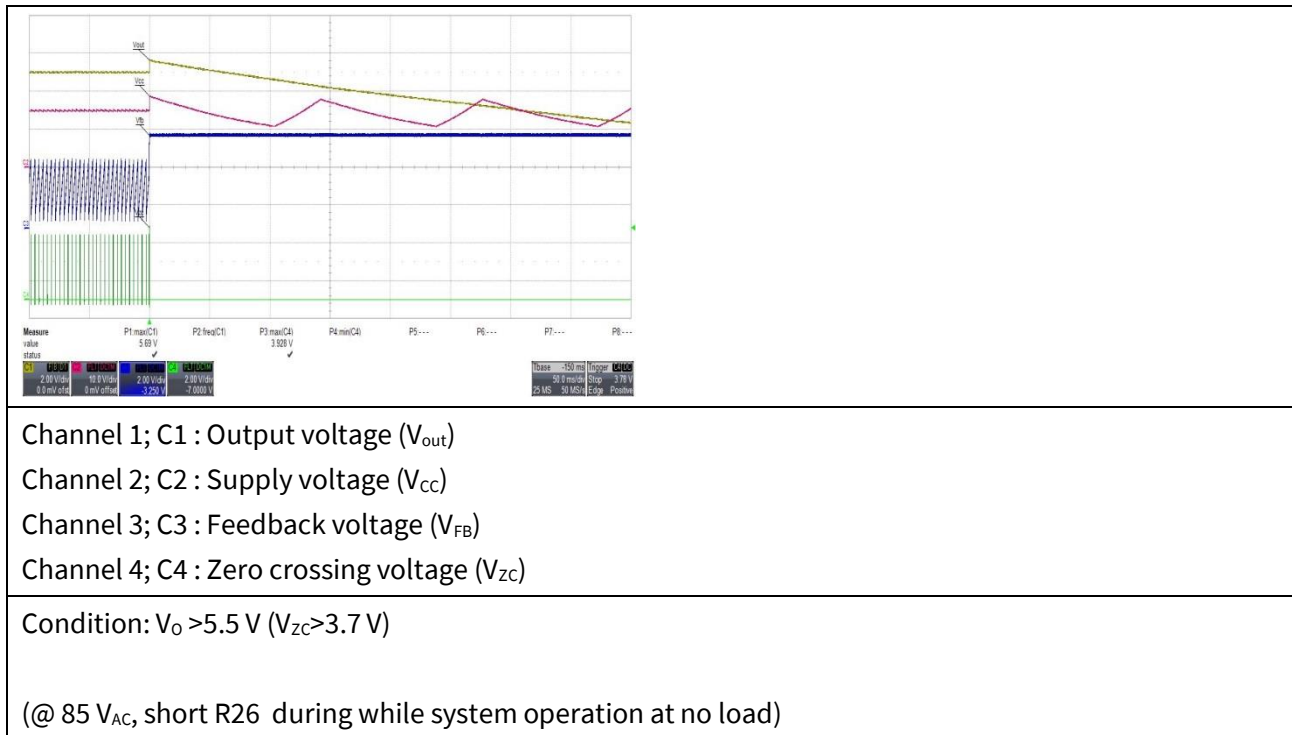
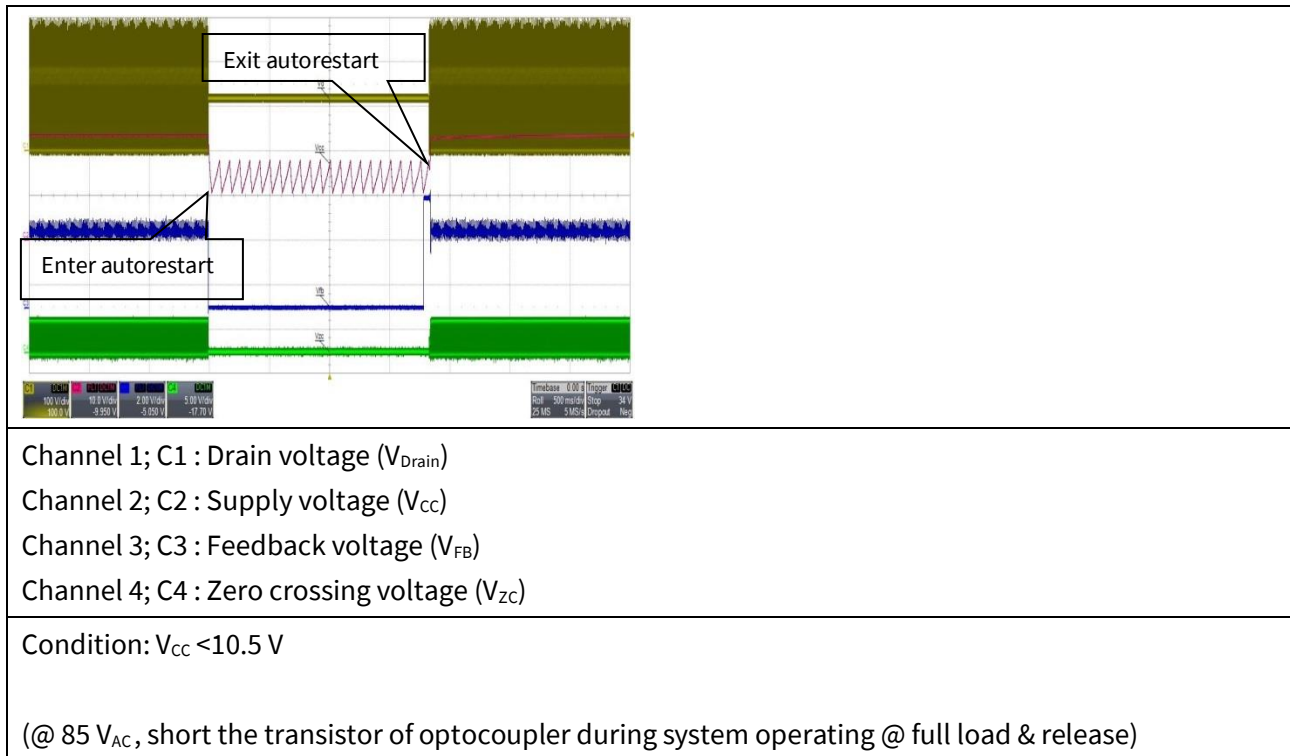

Figure 29 Output overvoltage protection

References

**12.13  $V_{CC}$  under voltage/Short optocoupler protection (Auto restart mode)**



**Figure 30  $V_{CC}$  under voltage/short optocoupler protection**

**13 References**

- [1] [ICE2QS03G data sheet, Infineon Technologies AG](#)
- [2] [IPL65R1K5C6S data sheet, 650V CoolMOS™ CE Power Transistor, Infineon Technologies AG](#)
- [3] [BSC067N06LS3 G data sheet, 60V OptiMOS™ 3 Power Transistor, Infineon Technologies AG](#)
- [4] [BAS21-03W data sheet, Infineon Technologies AG](#)
- [5] [ICE2QS03G design guide. \[ANPS0027\]](#)
- [6] [ThinPAK Product Brief](#)

**Revision History**

**Major changes since the last revision**

Page or Reference	Description of change
--	First Release

#### Trademarks of Infineon Technologies AG

AURIX™, C166™, CanPAK™, CIPOS™, CIPURSE™, CoolMOS™, CoolSET™, CORECONTROL™, CROSSAVE™, DAVE™, DI-POL™, EasyPIM™, EconoBRIDGE™, EconoDUAL™, EconoPIM™, EconoPACK™, EiceDRIVER™, eupec™, FCOS™, HITFET™, HybridPACK™, I<sup>2</sup>RF™, ISOFACE™, IsoPACK™, MIPAQ™, ModSTACK™, my-d™, NovalithIC™, OptiMOS™, ORIGA™, POWERCODE™, PRIMARION™, PrimePACK™, PrimeSTACK™, PRO-SIL™, PROFET™, RASIC™, ReverSave™, SatRIC™, SIEGET™, SINDRION™, SIPMOS™, SmartLEWIS™, SOLID FLASH™, TEMPFET™, thinQ!™, TRENCHSTOP™, TriCore™.

#### Other Trademarks

Advance Design System™ (ADS) of Agilent Technologies, AMBA™, ARM™, MULTI-ICE™, KEIL™, PRIMECELL™, REALVIEW™, THUMB™, μVision™ of ARM Limited, UK. AUTOSAR™ is licensed by AUTOSAR development partnership. Bluetooth™ of Bluetooth SIG Inc. CAT-iq™ of DECT Forum. COLOSSUS™, FirstGPS™ of Trimble Navigation Ltd. EMV™ of EMVCo, LLC (Visa Holdings Inc.). EPCOS™ of Epcos AG. FLEXGO™ of Microsoft Corporation. FlexRay™ is licensed by FlexRay Consortium. HYPERTERMINAL™ of Hilgraeve Incorporated. IEC™ of Commission Electrotechnique Internationale. IrDA™ of Infrared Data Association Corporation. ISO™ of INTERNATIONAL ORGANIZATION FOR STANDARDIZATION. MATLAB™ of MathWorks, Inc. MAXIM™ of Maxim Integrated Products, Inc. MICROTEC™, NUCLEUS™ of Mentor Graphics Corporation. MIPI™ of MIPI Alliance, Inc. MIPS™ of MIPS Technologies, Inc., USA. muRata™ of MURATA MANUFACTURING CO., MICROWAVE OFFICE™ (MWO) of Applied Wave Research Inc., OmniVision™ of OmniVision Technologies, Inc. Openwave™ Openwave Systems Inc. RED HAT™ Red Hat, Inc. RFMD™ RF Micro Devices, Inc. SIRIUS™ of Sirius Satellite Radio Inc. SOLARIS™ of Sun Microsystems, Inc. SPANSION™ of Spansion LLC Ltd. Symbian™ of Symbian Software Limited. TAIYO YUDEN™ of Taiyo Yuden Co. TEAKLITE™ of CEVA, Inc. TEKTRONIX™ of Tektronix Inc. TOKO™ of TOKO KABUSHIKI KAISHA TA. UNIX™ of X/Open Company Limited. VERILOG™, PALLADIUM™ of Cadence Design Systems, Inc. VLYNQ™ of Texas Instruments Incorporated. VXWORKS™, WIND RIVER™ of WIND RIVER SYSTEMS, INC. ZETEX™ of Diodes Zetex Limited.  
Last Trademarks Update 2011-11-11

[www.infineon.com](http://www.infineon.com)

**Edition 2015-03-12**

**Published by**

**Infineon Technologies AG**

**81726 Munich, Germany**

**© 2015 Infineon Technologies AG.**

**All Rights Reserved.**

**Do you have a question about any aspect of this document?**

**Email: [erratum@infineon.com](mailto:erratum@infineon.com)**

**Document reference**

**AN\_201409\_PL21\_014**

#### Legal Disclaimer

THE INFORMATION GIVEN IN THIS APPLICATION NOTE (INCLUDING BUT NOT LIMITED TO CONTENTS OF REFERENCED WEBSITES) IS GIVEN AS A HINT FOR THE IMPLEMENTATION OF THE INFINEON TECHNOLOGIES COMPONENT ONLY AND SHALL NOT BE REGARDED AS ANY DESCRIPTION OR WARRANTY OF A CERTAIN FUNCTIONALITY, CONDITION OR QUALITY OF THE INFINEON TECHNOLOGIES COMPONENT. THE RECIPIENT OF THIS APPLICATION NOTE MUST VERIFY ANY FUNCTION DESCRIBED HEREIN IN THE REAL APPLICATION. INFINEON TECHNOLOGIES HEREBY DISCLAIMS ANY AND ALL WARRANTIES AND LIABILITIES OF ANY KIND (INCLUDING WITHOUT LIMITATION WARRANTIES OF NON-INFRINGEMENT OF INTELLECTUAL PROPERTY RIGHTS OF ANY THIRD PARTY) WITH RESPECT TO ANY AND ALL INFORMATION GIVEN IN THIS APPLICATION NOTE.

#### Information

For further information on technology, delivery terms and conditions and prices, please contact the nearest Infineon Technologies Office ([www.infineon.com](http://www.infineon.com)).

#### Warnings

Due to technical requirements, components may contain dangerous substances. For information on the types in question, please contact the nearest Infineon Technologies Office. Infineon Technologies components may be used in life-support devices or systems only with the express written approval of Infineon Technologies, if a failure of such components can reasonably be expected to cause the failure of that life-support device or system or to affect the safety or effectiveness of that device or system. Life support devices or systems are intended to be implanted in the human body or to support and/or maintain and sustain and/or protect human life. If they fail, it is reasonable to assume that the health of the user or other persons may be endangered.





Компания «ЭлектроПласт» предлагает заключение долгосрочных отношений при поставках импортных электронных компонентов на взаимовыгодных условиях!

Наши преимущества:

- Оперативные поставки широкого спектра электронных компонентов отечественного и импортного производства напрямую от производителей и с крупнейших мировых складов;
- Поставка более 17-ти миллионов наименований электронных компонентов;
- Поставка сложных, дефицитных, либо снятых с производства позиций;
- Оперативные сроки поставки под заказ (от 5 рабочих дней);
- Экспресс доставка в любую точку России;
- Техническая поддержка проекта, помощь в подборе аналогов, поставка прототипов;
- Система менеджмента качества сертифицирована по Международному стандарту ISO 9001;
- Лицензия ФСБ на осуществление работ с использованием сведений, составляющих государственную тайну;
- Поставка специализированных компонентов (Xilinx, Altera, Analog Devices, Intersil, Interpoint, Microsemi, Aeroflex, Peregrine, Syfer, Eurofarad, Texas Instrument, Miteq, Cobham, E2V, MA-COM, Hittite, Mini-Circuits, General Dynamics и др.);

Помимо этого, одним из направлений компании «ЭлектроПласт» является направление «Источники питания». Мы предлагаем Вам помощь Конструкторского отдела:

- Подбор оптимального решения, техническое обоснование при выборе компонента;
- Подбор аналогов;
- Консультации по применению компонента;
- Поставка образцов и прототипов;
- Техническая поддержка проекта;
- Защита от снятия компонента с производства.



#### Как с нами связаться

**Телефон:** 8 (812) 309 58 32 (многоканальный)

**Факс:** 8 (812) 320-02-42

**Электронная почта:** [org@eplast1.ru](mailto:org@eplast1.ru)

**Адрес:** 198099, г. Санкт-Петербург, ул. Калинина, дом 2, корпус 4, литера А.