

Analog Devices Welcomes Hittite Microwave Corporation

NO CONTENT ON THE ATTACHED DOCUMENT HAS CHANGED



THIS PAGE INTENTIONALLY LEFT BLANK



SMT GaAs MMIC x2 ACTIVE FREQUENCY MULTIPLIER, 13 - 24.6 GHz OUTPUT

Typical Applications

The HMC814LC3B is ideal for:

- Clock Generation Applications:
SONET OC-192 & SDH STM-64
- Point-to-Point & VSAT Radios
- Test Instrumentation
- Military & Space
- Sensors

Features

- High Output Power: +17 dBm
- Low Input Power Drive: 0 to +6 dBm
- Fo Isolation: >20 dBc @ Fout = 19 GHz
- 100 kHz SSB Phase Noise: -136 dBc/Hz
- Single Supply: +5V @ 88 mA
- 12 Lead 3x3 mm SMT Package: 9 mm²

Functional Diagram

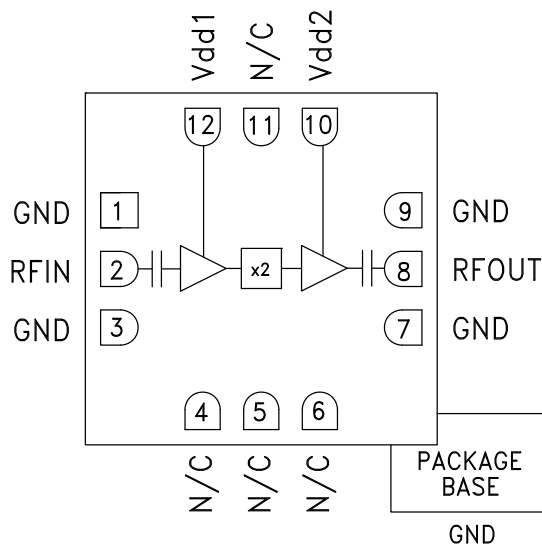

General Description

The HMC814LC3B is a x2 active broadband frequency multiplier utilizing GaAs pHEMT technology in a leadless RoHS compliant SMT package. When driven by a +4 dBm signal, the multiplier provides +17 dBm typical output power from 13 to 24.6 GHz. The Fo, 3Fo and 4Fo isolations are >20 dBc at 19 GHz. The HMC814LC3B is ideal for use in LO multiplier chains for Pt-to-Pt & VSAT Radios yielding reduced parts count vs. traditional approaches. The low additive SSB Phase Noise of -136 dBc/Hz at 100 kHz offset helps maintain good system noise performance. The RoHS packaged HMC814LC3B eliminates the need for wire bonding, and allows the use of surface mount manufacturing techniques.

Electrical Specifications, $T_A = +25^\circ C$, $V_{dd1}, V_{dd2} = +5V$, +4 dBm Drive Level

Parameter	Min.	Typ.	Max.	Units
Frequency Range, Input	6.5 - 12.3			GHz
Frequency Range, Output	13 - 24.6			GHz
Output Power	14	17		dBm
Fo Isolation (with respect to output level)		25		dBc
3Fo Isolation (with respect to output level)		25		dBc
Input Return Loss	4	10		dB
Output Return Loss	6	12		dB
SSB Phase Noise (100 kHz Offset @ Input Frequency = 19 GHz)		-136		dBc/Hz
Supply Current (I _{dd1} & I _{dd2})	70	88	100	mA

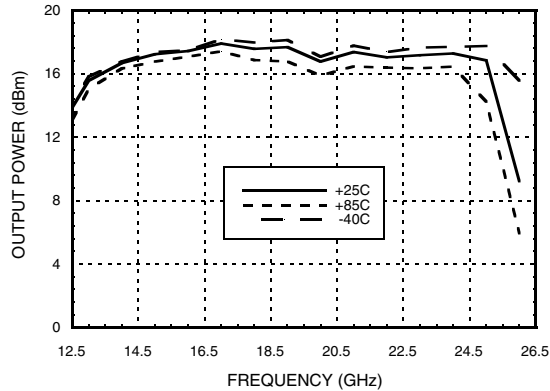
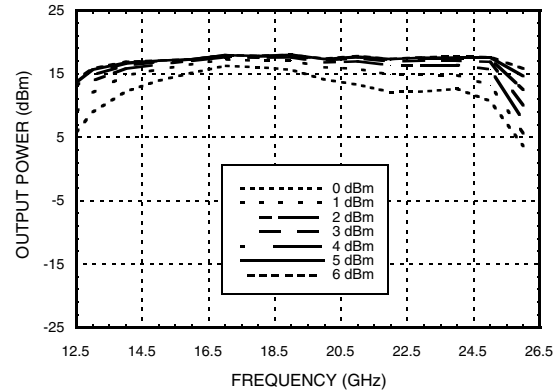
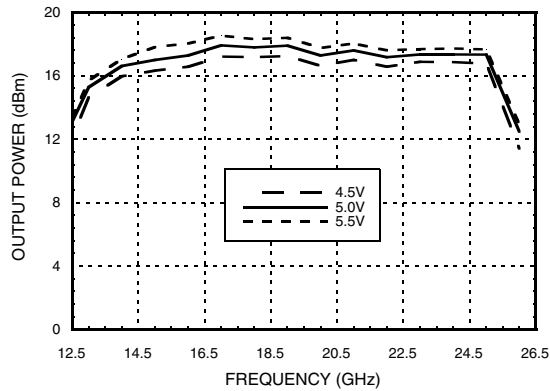
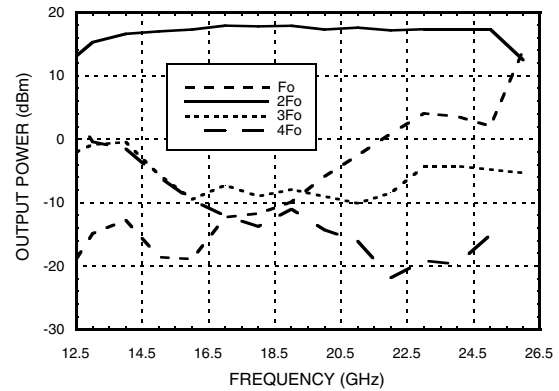
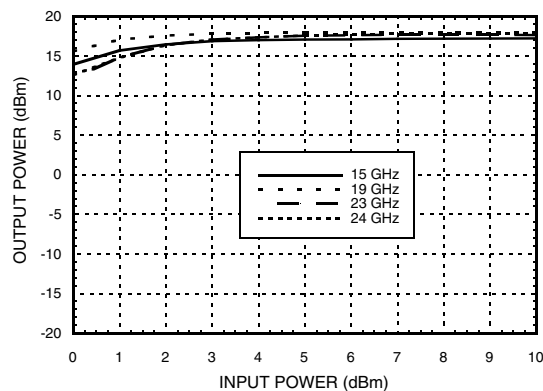
SMT GaAs MMIC x2 ACTIVE FREQUENCY MULTIPLIER, 13 - 24.6 GHz OUTPUT
Output Power vs. Temperature @ +4 dBm Drive Level

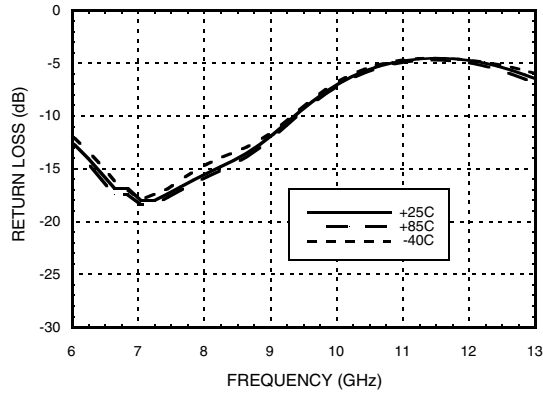
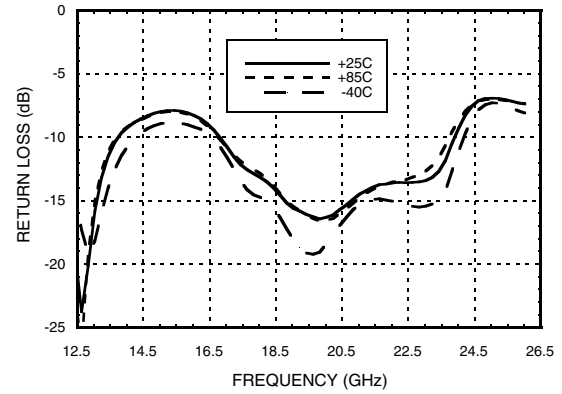
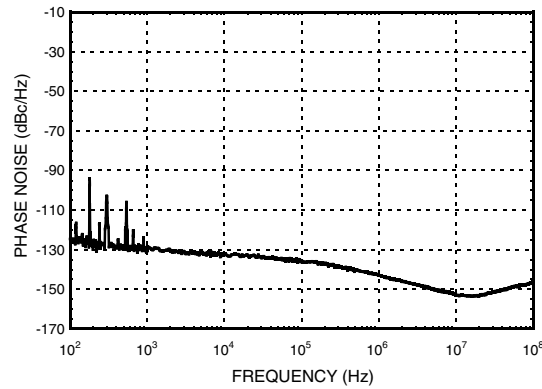
Output Power vs. Drive Level

Output Power vs. Supply Voltage @ +4 dBm Drive Level

Isolation @ +4 dBm Drive Level

Output Power vs. Input Power



SMT GaAs MMIC x2 ACTIVE FREQUENCY MULTIPLIER, 13 - 24.6 GHz OUTPUT
Input Return Loss vs. Temperature

Output Return Loss vs. Temperature

Phase Noise @ 19 GHz

SMT GaAs MMIC x2 ACTIVE FREQUENCY MULTIPLIER, 13 - 24.6 GHz OUTPUT

Absolute Maximum Ratings

RF Input (Vdd = +5V)	+10 dBm
Supply Voltage (Vdd1, Vdd2)	+5.5 Vdc
Channel Temperature	175 °C
Continuous Pdiss (T= 85 °C) (derate 8.3 mW/°C above 85 °C)	743 mW
Thermal Resistance (channel to ground paddle)	121 °C/W
Storage Temperature	-65 to +150 °C
Operating Temperature	-40 to +85 °C
ESD Sensitivity (HBM)	Class 0 (Passed 150 V)

Typical Supply Current vs. Vdd

Vdd (Vdc)	Idd (mA)
4.5	87
5.0	88
5.5	89

Note:
Multiplier will operate over full voltage range shown above.



ELECTROSTATIC SENSITIVE DEVICE
OBSERVE HANDLING PRECAUTIONS

Outline Drawing

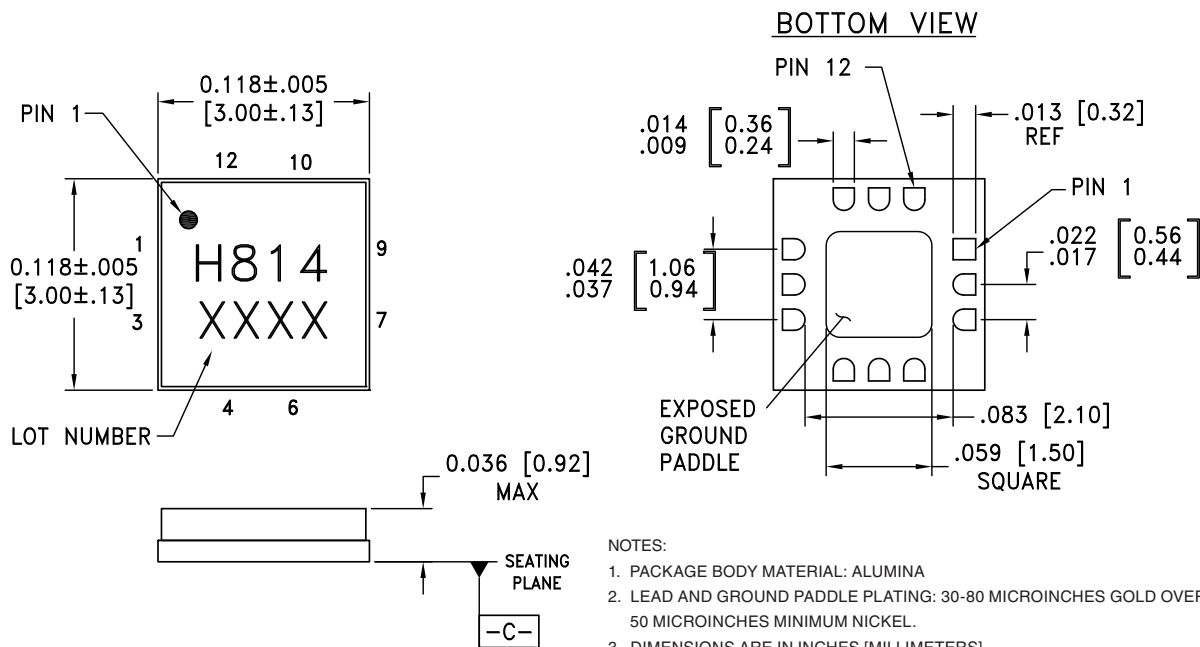

- NOTES:
1. PACKAGE BODY MATERIAL: ALUMINA
 2. LEAD AND GROUND PADDLE PLATING: 30-80 MICROINCHES GOLD OVER 50 MICROINCHES MINIMUM NICKEL.
 3. DIMENSIONS ARE IN INCHES [MILLIMETERS].
 4. LEAD SPACING TOLERANCE IS NON-CUMULATIVE
 5. PACKAGE WARP SHALL NOT EXCEED 0.05mm DATUM [-C-]
 6. ALL GROUND LEADS AND GROUND PADDLE MUST BE SOLDERED TO PCB RF GROUND.

Package Information

Part Number	Package Body Material	Lead Finish	MSL Rating	Package Marking [2]
HMC814LC3B	Alumina, White	Gold over Nickel	MSL3 [1]	H814 XXXX

[1] Max peak reflow temperature of 260 °C

[2] 4-Digit lot number XXXX

SMT GaAs MMIC x2 ACTIVE FREQUENCY MULTIPLIER, 13 - 24.6 GHz OUTPUT
Pin Description

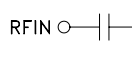
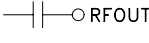
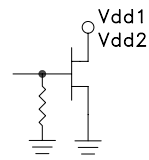
Pin Number	Function	Description	Interface Schematic
1, 3, 7, 9	GND	Package bottom must also be connected to RF/DC ground.	
2	RFIN	This pin is AC coupled and matched to 50 Ohms.	
4 - 6, 11	N/C	These pins are not connected internally; however, all data shown herein was measured with these pins connected to RF/ DC ground.	
8	RFOUT	This pin is AC coupled and matched to 50 Ohms.	
10, 12	Vdd2, Vdd1	Supply voltage 5V ± 0.5V. External bypass capacitors of 100 pF, 1,000 pF and 2.2 μF are recommended.	

Application Circuit

Component	Value
C1, C2	100 pF
C3, C4	1,000 pF
C5, C6	2.2 μF

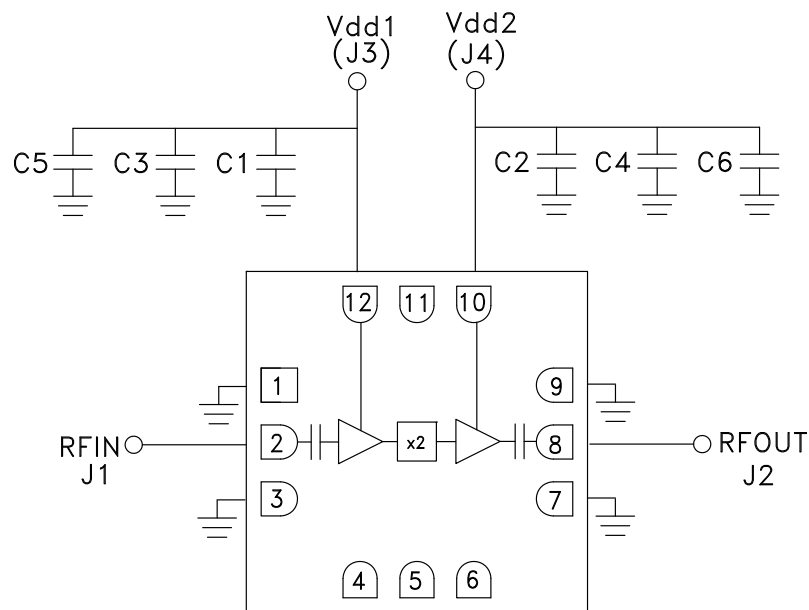



SMT GaAs MMIC x2 ACTIVE FREQUENCY MULTIPLIER, 13 - 24.6 GHz OUTPUT

Evaluation PCB

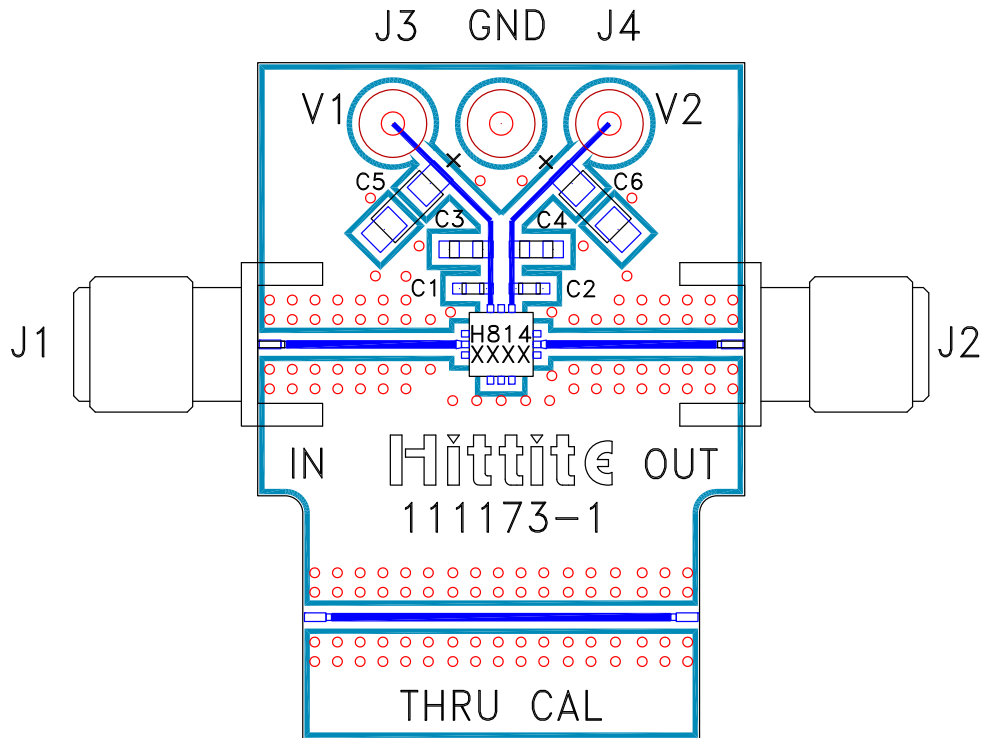

List of Materials for Evaluation PCB 112409 [1]

Item	Description
J1, J2	PCB Mount SRI K Connector
J3 - J5	DC Pin
C1, C2	100 pF Capacitor, 0402 Pkg.
C3, C4	1,000 pF Capacitor, 0603 Pkg.
C5, C6	2.2 μF Tantalum Capacitor
U1	HMC814LC3B x2 Active Multiplier
PCB [2]	111173 Eval Board

[1] Reference this number when ordering complete evaluation PCB

[2] Circuit Board Material: Rogers 4350 or Arlon 25FR

The circuit board used in the application should be generated with proper RF circuit design techniques. Signal lines should have 50 Ohm impedance while the package ground leads and exposed paddle should be connected directly to the ground plane similar to that shown. A sufficient number of via holes should be used to connect the top and bottom ground planes. The evaluation circuit board shown is available from Hittite upon request.



Компания «ЭлектроПласт» предлагает заключение долгосрочных отношений при поставках импортных электронных компонентов на взаимовыгодных условиях!

Наши преимущества:

- Оперативные поставки широкого спектра электронных компонентов отечественного и импортного производства напрямую от производителей и с крупнейших мировых складов;
- Поставка более 17-ти миллионов наименований электронных компонентов;
- Поставка сложных, дефицитных, либо снятых с производства позиций;
- Оперативные сроки поставки под заказ (от 5 рабочих дней);
- Экспресс доставка в любую точку России;
- Техническая поддержка проекта, помощь в подборе аналогов, поставка прототипов;
- Система менеджмента качества сертифицирована по Международному стандарту ISO 9001;
- Лицензия ФСБ на осуществление работ с использованием сведений, составляющих государственную тайну;
- Поставка специализированных компонентов (Xilinx, Altera, Analog Devices, Intersil, Interpoint, Microsemi, Aeroflex, Peregrine, Syfer, Eurofarad, Texas Instrument, Miteq, Cobham, E2V, MA-COM, Hittite, Mini-Circuits, General Dynamics и др.);

Помимо этого, одним из направлений компании «ЭлектроПласт» является направление «Источники питания». Мы предлагаем Вам помощь Конструкторского отдела:

- Подбор оптимального решения, техническое обоснование при выборе компонента;
- Подбор аналогов;
- Консультации по применению компонента;
- Поставка образцов и прототипов;
- Техническая поддержка проекта;
- Защита от снятия компонента с производства.



Как с нами связаться

Телефон: 8 (812) 309 58 32 (многоканальный)

Факс: 8 (812) 320-02-42

Электронная почта: org@eplast1.ru

Адрес: 198099, г. Санкт-Петербург, ул. Калинина, дом 2, корпус 4, литера А.