

Generation 3 CXM-6 COB Arrays White LED



Table of Contents

Technology Overview	2
Chromaticity Bins	3
Product Ordering & Shipping Part Numbers	4
Product Typical Flux Range .5	
Operating Characteristics	10
Optical and Electrical Character- istics	11
Spectra	14
Mechanical Dimensions . .	15
Packaging Information . . .	16
Handling Notes	17

Features:

- High lumen output and efficacy typical
 - Over 700 lm, 135 LPW @ 3000K, 80 CRI, $T_j = 85^\circ\text{C}$
 - Over 795 lm, 152 LPW @ 5000K, 70 CRI, $T_j = 85^\circ\text{C}$
- CCT range 2400K, 2700K, 3000K, 3200K, 3500K, 4000K, 5000K, 5600K, 6500K, 8000K
- 80 or 90 CRI min. up to 95 min. in warm white
- 3 SDCM color binning accuracy
- Excellent optical emission uniformity and color over angle consistency
- Exceptional long term color stability
- Superior thermal conductivity for uniform heat spreading
- Environmentally friendly: RoHS and REACH compliant



Applications

- | | |
|---------------------------|-------------------------------|
| • Spotlights/Track Lights | • Shop Lighting |
| • Downlights | • Hospitality Lighting |
| • Replacement lamps | • Architectural and Specialty |

Technology Overview

Luminus Chip-on-Board (COB) LED series offers a complete lighting class solution designed for high performance illumination applications. The selection covers a wide lumen range from less than 400lm to over 10,000lm, all major color temperatures and can deliver color rendering greater than 97 at 2700K and 3000K and R9 equal to 95.

Reliability

Designed from the ground up, the Luminus COB LED is one of the most reliable light sources in the world today. Having passed a rigorous suite of environmental and mechanical stress tests, including mechanical shock, vibration, temperature cycling and humidity. Only then are the devices qualified for use in a wide range of lighting application including some of the most demanding commercial applications. Delivered with fully qualified LM80 test data and TM21 lifetime results that certify lumen maintenance at 35,000 hours or more, Luminus COB LEDs are ready for the toughest challenges.

UL Recognized Compliance

Luminus COB arrays are tested in accordance with ANSI/UL 8750 to ensure safe operation for their intended applications.

REACH & RoHS Compliance

All LED products manufactured by Luminus are REACH and RoHS compliant and free of hazardous materials, including lead and mercury.

Understanding Luminus COB LED Test Specifications

Every Luminus LED is fully tested to ensure it meets the high quality standards customers have come to expect from Luminus' products.

Traceability

Each Luminus COB LED is marked with a 2D bar code that contains a unique serial number. With this serial number, Luminus has the ability to provide customers with actual test data measurements for a specific LED. In addition, the 2D bar code is linked to manufacturing date codes that enables traceability of production processes and materials.

Chromaticity Bin Range

Chromaticity binning delivers color consistency for every order. Standard products are delivered with a 3-step MacAdam ellipse. This ensures color performance matching in the application. These tightly controlled, small distribution bins provide customers predictable, repeatable colors.

Testing Temperature

Luminus COB products are measured at temperatures typical for the LED operating in the fixture. Each device is tested at 85°C junction temperature eliminating the need to scale datasheet specifications to real world situations.

Chromaticity Bin Structure

Chromaticity Bins: 1931 CIE Curve

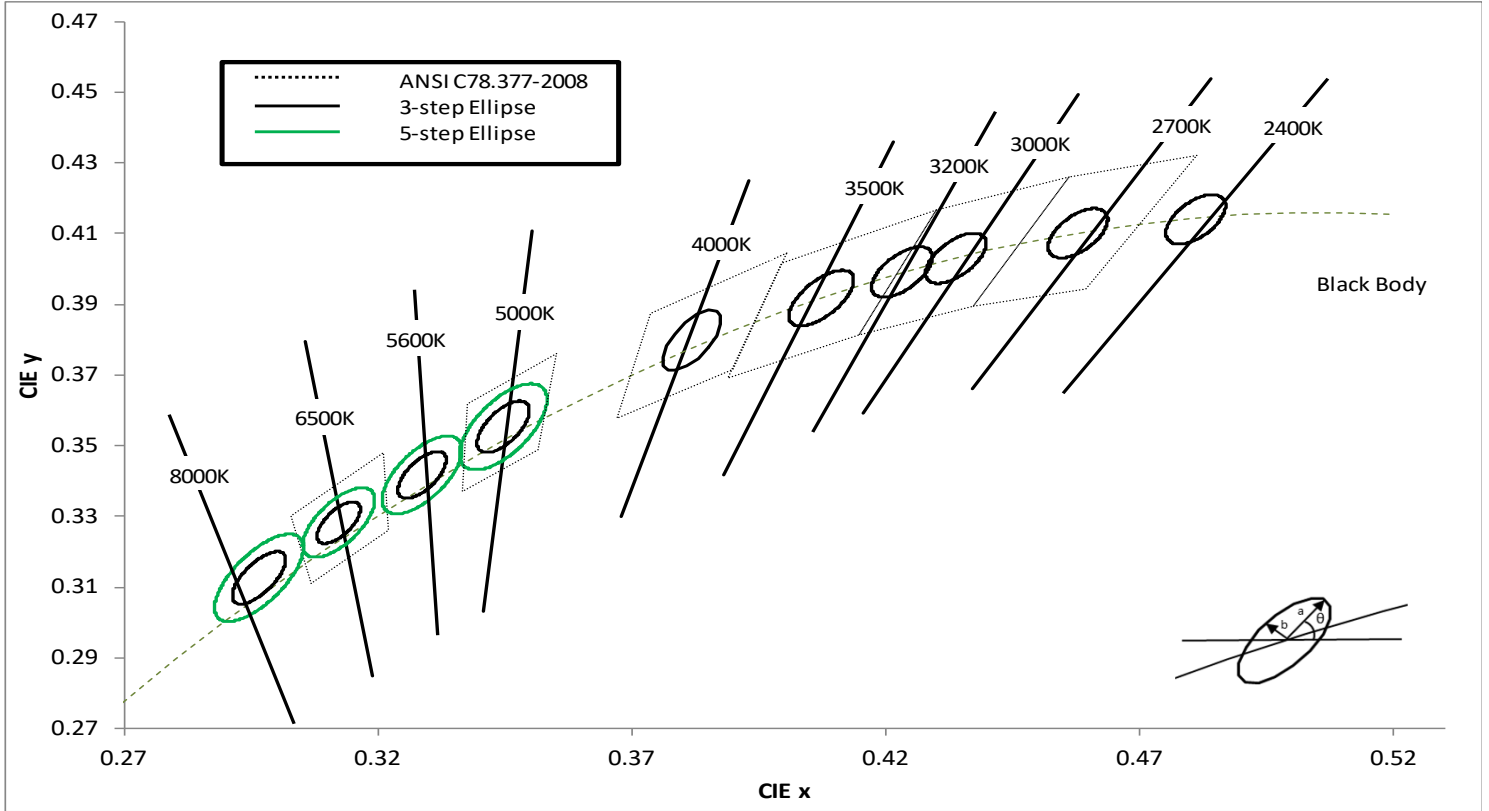

CXM-6 White Chromaticity Bins

The following tables describe the ANSI bin center points, the orientation angle for the MacAdam ellipse (θ°), and the maximum radii for the ellipses. The ANSI Bin is provided for reference.

CCT	Center Point		Angle θ°	3-step Bin		5-step Bin	
	CIE _x	CIE _y		a	b	a	b
2400K	0.4810	0.4140	53.7	0.0081	0.0042		
2700K	0.4578	0.4101	53.7	0.0081	0.0042		
3000K	0.4338	0.403	53.2	0.00834	0.00408		
3200K	0.4232	0.3991	53.2	0.0108	0.0056		
3500K	0.4073	0.3917	54	0.00927	0.00414		
4000K	0.3818	0.3797	53.7	0.00939	0.00402		
5000K	0.3447	0.3553	59.6	0.00822	0.00354	0.0137	0.0059
5600K	0.3287	0.3417	59.09	0.00746	0.0032	0.0124	0.0053
6500K	0.3123	0.3282	58.57	0.00669	0.00285	0.01115	0.00475
8000K	0.2966	0.3126	58.64	0.00844	0.00334	0.01407	0.00557

*Note: Luminus maintains a +/- 0.005 tolerance on chromaticity (CIE_x and CIE_y) measurements.

Product Ordering and Shipping Part Number Nomenclature

All CXM-6 products are packaged and labeled with part numbers as outlined in the table on page 5 and 6. When shipped, each package will contain only a single flux and chromaticity bin. The part number designation is as follows:

CXM — 6 — NN — XX — VV — QQPP — FFG — W

Product Family	Light Emitting Surface Diameter	Color Temperature	Color Rendering Index (CRI)	Voltage (typical)	Package Configurator ²	Flux Bin	Chromaticity Bin
CXM: Chip on Board, Multi-die	6.3 : LES Diameter (mm)	Color See Note 1 below	CRI	Volts	AA30 (Basic package)	Lumens	See page 3 for bins

Note 1: NN nomenclature corresponds to the following:

- 24 = 2400K
- 27 = 2700K
- 30 = 3000K
- 32 = 3200K
- 35 = 3500K
- 40 = 4000K
- 50 = 5000K
- 56 = 5600K
- 65 = 6500K
- 80 = 8000K

Note 2: AA is standard package configurator

AC is an alternative

Color Temperature, CRI and R9 Values

Color Temperatures	XX Value	CRI	R9
5000K, 6500K, 8000K	70	>70	-
2700K, 3000K, 3500K, 4000K, 5000K, 6500K	80	>80	>0
2400K, 2700K, 3000K, 3500K, 4000K, 5000K	90	>90	>50
2700K, 3000K, 3200K	95	>95	>85
3500K, 4000K, 5000K, 5600K			>75

Note: Luminus part numbers may be accompanied by prefixes or suffixes. The most common is the "Rev01" suffix indicating a part is fully released and carries a full warranty. These additional characters may appear on shipping labels, packing slips and invoices. In all cases the basic part number described above will always be included.

CXM-6 Part Numbers (36V, AA30)

The following tables describe the products with a maximum and minimum output flux measured at 150mA and specified at Tj = 85°C. The values at 25°C are calculated and shown for reference only.

CCT	Output Flux (lm)		Reference	Color Rendering Index	Ordering Part Number
	Typ. (85°C)	Min.. (85°C)	Max. (calculated) (25°C)	CRI (min.)	3-step MacAdam Ellipse
2400K	525	490	565	90	CXM-6-24-90-36-AA30-F4-3
2700K	660	615	730	80	CXM-6-27-80-36-AA30-F4-3
	560	520	615	90	CXM-6-27-90-36-AA30-F4-3
	525	485	575	95	CXM-6-27-95-36-AA30-F4-3
3000K	700	650	770	80	CXM-6-30-80-36-AA30-F4-3
	590	550	650	90	CXM-6-30-90-36-AA30-F4-3
	550	510	605	95	CXM-6-30-95-36-AA30-F4-3
3200K	555	515	600	95	CXM-6-32-95-36-AA30-F4-3
3500K	720	670	795	80	CXM-6-35-80-36-AA30-F4-3
	601	560	660	90	CXM-6-35-90-36-AA30-F4-3
	575	535	630	95	CXM-6-35-95-36-AA30-F4-3
4000K	730	680	805	80	CXM-6-40-80-36-AA30-F4-3
	635	590	695	90	CXM-6-40-90-36-AA30-F4-3
	585	545	645	95	CXM-6-40-95-36-AA30-F4-3

CCT	Output Flux (lm)		Reference	Color Rendering Index	Ordering Part Number	
	Typ. (85°C)	Min.. (85°C)	Max. (calculated) (25°C)	CRI (min.)	5-step MacAdam Ellipse	3-step MacAdam Ellipse
5000K	795	740	875	70	CXM-6-50-70-36-AA30-F4-5	CXM-6-50-70-36-AA30-F4-3
	735	685	810	80	CXM-6-50-80-36-AA30-F4-5	CXM-6-50-80-36-AA30-F4-3
	635	590	700	90	CXM-6-50-90-36-AA30-F4-5	CXM-6-50-90-36-AA30-F4-3
	585	545	645	95	CXM-6-50-95-36-AA30-F4-5	CXM-6-50-95-36-AA30-F4-3
5600K	585	545	645	95	CXM-6-56-95-36-AA30-F4-5	CXM-6-56-95-36-AA30-F4-3
6500K	795	740	875	70	CXM-6-65-70-36-AA30-F4-5	CXM-6-65-70-36-AA30-F4-3
	735	680	805	80	CXM-6-65-80-36-AA30-F4-5	CXM-6-65-80-36-AA30-F4-3
8000K	795	740	860	70	CXM-6-80-70-36-AA30-F4-5	CXM-6-80-70-36-AA30-F4-3

*Note: Luminus maintains a +/- 6% tolerance on flux measurements.
Luminus maintains a +/- 2% tolerance on CRI measurements.

CXM-6 Part Numbers (36V, AC30)

The following tables describe the products with a maximum and minimum output flux measured at 150mA and specified at $T_j = 85^\circ\text{C}$. The values at 25°C are calculated and shown for reference only.

CCT	Output Flux (lm)		Reference	Color Rendering Index	Ordering Part Number
	Typ. (85°C)	Min.. (85°C)	Max. (calculated) (25°C)	CRI (min.)	3-step MacAdam Ellipse
2700K	660	615	730	80	CXM-6-27-80-36-AC30-F4-3
	560	520	615	90	CXM-6-27-90-36-AC30-F4-3
	525	485	575	95	CXM-6-27-95-36-AC30-F4-3
3000K	700	650	770	80	CXM-6-30-80-36-AC30-F4-3
	590	550	650	90	CXM-6-30-90-36-AC30-F4-3
	550	510	605	95	CXM-6-30-95-36-AC30-F4-3
3200K	555	515	600	95	CXM-6-32-95-36-AC30-F4-3
3500K	720	670	795	80	CXM-6-35-80-36-AC30-F4-3
	601	560	660	90	CXM-6-35-90-36-AC30-F4-3
	575	535	630	95	CXM-6-35-95-36-AC30-F4-3
4000K	730	680	805	80	CXM-6-40-80-36-AC30-F4-3
	635	590	695	90	CXM-6-40-90-36-AC30-F4-3
	585	545	645	95	CXM-6-40-95-36-AC30-F4-3

CCT	Output Flux (lm)		Reference	Color Rendering Index	Ordering Part Number	
	Typ. (85°C)	Min.. (85°C)	Max. (calculated) (25°C)	CRI (min.)	5-step MacAdam Ellipse	3-step MacAdam Ellipse
5000K	795	740	875	70	CXM-6-50-70-36-AC30-F4-5	CXM-6-50-70-36-AC30-F4-3
	735	685	810	80	CXM-6-50-80-36-AC30-F4-5	CXM-6-50-80-36-AC30-F4-3
	635	590	700	90	CXM-6-50-90-36-AC30-F4-5	CXM-6-50-90-36-AC30-F4-3
	585	545	645	95	CXM-6-50-95-36-AC30-F4-5	CXM-6-50-95-36-AC30-F4-3
6500K	795	740	875	70	CXM-6-65-70-36-AC30-F4-5	CXM-6-65-70-36-AC30-F4-3
	735	680	805	80	CXM-6-65-80-36-AC30-F4-5	CXM-6-65-80-36-AC30-F4-3

*Note: Luminus maintains a +/- 6% tolerance on flux measurements.
Luminus maintains a +/- 2% tolerance on CRI measurements.

CXM-6 Part Numbers (18V, AA30)

The following tables describe products with typical flux and minimum flux measured at 300mA and specified at Tj = 85°C. The values at 25°C are calculated and shown for reference only. All product is measured and specified at 85°C junction temperature.

CCT	Output Flux (lm)		Reference	Color Rendering Index	Ordering Part Number
	Typ. (85°C)	Min.. (85°C)	Max. (calculated) (25°C)	CRI (min.)	3-step MacAdam Ellipse
2700K	660	615	730	80	CXM-6-27-80-18-AA30-F4-3
	560	520	615	90	CXM-6-27-90-18-AA30-F4-3
	525	485	575	95	CXM-6-27-95-18-AA30-F4-3
3000K	700	650	770	80	CXM-6-30-80-18-AA30-F4-3
	590	550	650	90	CXM-6-30-90-18-AA30-F4-3
	550	510	605	95	CXM-6-30-95-18-AA30-F4-3
3500K	720	670	795	80	CXM-6-35-80-18-AA30-F4-3
	601	560	660	90	CXM-6-35-90-18-AA30-F4-3
	575	535	630	95	CXM-6-35-95-18-AA30-F4-3
4000K	730	680	805	80	CXM-6-40-80-18-AA30-F4-3
	635	590	695	90	CXM-6-40-90-18-AA30-F4-3
	585	545	645	95	CXM-6-40-95-18-AA30-F4-3

CCT	Output Flux (lm)		Reference	Color Rendering Index	Ordering Part Number	
	Typ. (85°C)	Min.. (85°C)	Max. (calculated) (25°C)	CRI (min.)	5-step MacAdam Ellipse	3-step MacAdam Ellipse
5000K	795	740	875	70	CXM-6-50-70-18-AA30-F4-5	CXM-6-50-70-18-AA30-F4-3
	735	685	810	80	CXM-6-50-80-18-AA30-F4-5	CXM-6-50-80-18-AA30-F4-3
	635	590	700	90	CXM-6-50-90-18-AA30-F4-5	CXM-6-50-90-18-AA30-F4-3
	585	545	645	95	CXM-6-50-95-18-AA30-F4-5	CXM-6-50-95-18-AA30-F4-3
6500K	795	740	875	70	CXM-6-65-70-18-AA30-F4-5	CXM-6-65-70-18-AA30-F4-3
	735	680	805	80	CXM-6-65-80-18-AA30-F4-5	CXM-6-65-80-18-AA30-F4-3

*Note: Luminus maintains a +/- 6% tolerance on flux measurements.
Luminus maintains a +/- 2% tolerance on CRI measurements.

CXM-6 Part Numbers (18V, AC30)

The following tables describe products with typical flux and minimum flux measured at 300mA and specified at Tj = 85°C. The values at 25°C are calculated and shown for reference only. All product is measured and specified at 85°C junction temperature.

CCT	Output Flux (lm)		Reference	Color Rendering Index	Ordering Part Number
	Typ. (85°C)	Min.. (85°C)	Max. (calculated) (25°C)	CRI (min.)	3-step MacAdam Ellipse
2700K	660	615	730	80	CXM-6-27-80-18-AC30-F4-3
	560	520	615	90	CXM-6-27-90-18-AC30-F4-3
	525	485	575	95	CXM-6-27-95-18-AC30-F4-3
3000K	700	650	770	80	CXM-6-30-80-18-AC30-F4-3
	590	550	650	90	CXM-6-30-90-18-AC30-F4-3
	550	510	605	95	CXM-6-30-95-18-AC30-F4-3
3500K	720	670	795	80	CXM-6-35-80-18-AC30-F4-3
	601	560	660	90	CXM-6-35-90-18-AC30-F4-3
	575	535	630	95	CXM-6-35-95-18-AC30-F4-3
4000K	730	680	805	80	CXM-6-40-80-18-AC30-F4-3
	635	590	695	90	CXM-6-40-90-18-AC30-F4-3
	585	545	645	95	CXM-6-40-95-18-AC30-F4-3

CCT	Output Flux (lm)		Reference	Color Rendering Index	Ordering Part Number	
	Typ. (85°C)	Min.. (85°C)	Max. (calculated) (25°C)	CRI (min.)	5-step MacAdam Ellipse	3-step MacAdam Ellipse
5000K	795	740	875	70	CXM-6-50-70-18-AC30-F4-5	CXM-6-50-70-18-AC30-F4-3
	735	685	810	80	CXM-6-50-80-18-AC30-F4-5	CXM-6-50-80-18-AC30-F4-3
	635	590	700	90	CXM-6-50-90-18-AC30-F4-5	CXM-6-50-90-18-AC30-F4-3
	585	545	645	95	CXM-6-50-95-18-AC30-F4-5	CXM-6-50-95-18-AC30-F4-3
6500K	795	740	875	70	CXM-6-65-70-18-AC30-F4-5	CXM-6-65-70-18-AC30-F4-3
	735	680	805	80	CXM-6-65-80-18-AC30-F4-5	CXM-6-65-80-18-AC30-F4-3

*Note: Luminus maintains a +/- 6% tolerance on flux measurements.
Luminus maintains a +/- 2% tolerance on CRI measurements.

CXM-6 Part Numbers (9V, AC30)

The following tables describe products with typical flux and minimum flux measured at 300mA and specified at $T_j = 85^\circ\text{C}$. The values at 25°C are calculated and shown for reference only. All product is measured and specified at 85°C junction temperature.

CCT	Output Flux (lm)		Reference	Color Rendering Index	Ordering Part Number
	Typ. (85°C)	Min.. (85°C)	Max. (calculated) (25°C)	CRI (min.)	3-step MacAdam Ellipse
2700K	660	615	730	80	CXM-6-27-80-9-AC30-F4-3
	560	520	615	90	CXM-6-27-90-9-AC30-F4-3
	525	485	575	95	CXM-6-27-95-9-AC30-F4-3
3000K	700	650	770	80	CXM-6-30-80-9-AC30-F4-3
	590	550	650	90	CXM-6-30-90-9-AC30-F4-3
	550	510	605	95	CXM-6-30-95-9-AC30-F4-3
3500K	720	670	795	80	CXM-6-35-80-9-AC30-F4-3
	601	560	660	90	CXM-6-35-90-9-AC30-F4-3
	575	535	630	95	CXM-6-35-95-9-AC30-F4-3
4000K	730	680	805	80	CXM-6-40-80-9-AC30-F4-3
	635	590	695	90	CXM-6-40-90-9-AC30-F4-3
	585	545	645	95	CXM-6-40-95-9-AC30-F4-3

CCT	Output Flux (lm)		Reference	Color Rendering Index	Ordering Part Number	
	Typ. (85°C)	Min.. (85°C)	Max. (calculated) (25°C)	CRI (min.)	5-step MacAdam Ellipse	3-step MacAdam Ellipse
5000K	795	740	875	70	CXM-6-50-70-9-AC30-F4-5	CXM-6-50-70-9-AC30-F4-3
	735	685	810	80	CXM-6-50-80-9-AC30-F4-5	CXM-6-50-80-9-AC30-F4-3
	635	590	700	90	CXM-6-50-90-9-AC30-F4-5	CXM-6-50-90-9-AC30-F4-3
	585	545	645	95	CXM-6-50-95-9-AC30-F4-5	CXM-6-50-95-9-AC30-F4-3
6500K	795	740	875	70	CXM-6-65-70-9-AC30-F4-5	CXM-6-65-70-9-AC30-F4-3
	735	680	805	80	CXM-6-65-80-9-AC30-F4-5	CXM-6-65-80-9-AC30-F4-3

*Note: Luminus maintains a +/- 6% tolerance on flux measurements.
Luminus maintains a +/- 2% tolerance on CRI measurements.

CXM-6 Operating Characteristics¹
Electrical Characteristics

Parameter - 36V	Symbol	Minimum	Typical	Maximum	Unit
Forward Current ²	I_f		150	325	mA
Forward Voltage ³	V_f	31	34.6	37	V

Parameter - 18V	Symbol	Minimum	Typical	Maximum	Unit
Forward Current ²	I_f		300	650	mA
Forward Voltage ³	V_f	15.5	17.3	18.5	V

Parameter - 9V	Symbol	Minimum	Typical	Maximum	Unit
Forward Current ²	I_f		600	1300	mA
Forward Voltage ³	V_f	7.7	8.7	9.3	V

Optical and Electrical Characteristics

Parameter	Symbol	Minimum	Typical	Maximum	Unit
Power			5.2	11.8	W
Operating Case Temperature ⁴	T_c			105	°C
Light Emitting Surface Diameter	LES		6.3		mm
Thermal Resistance (junction-to-case)	Θ_{jc}		0.96		°C/W
Junction Temperature	T_j			140	°C
Viewing Angle			120		Degree

Note 1: Ratings are based on operation at a constant junction temperature of $T_j = 85^\circ\text{C}$.

Note 2: To prevent damage refer to operating conditions and derating curves for appropriate maximum operating conditions

Note 3: Voltage is rated at typical forward current. For voltage at higher drive current, refer to performance graphs.

Note 4: Device operation not recommended at drive currents less than 10% of the typical value

Note 5: Caution must be taken not to stare at the light emitted from these LEDs. Under special circumstances, the high intensity could damage the eye.

Note 6: All product operating specifications are subject to change without advance notice.

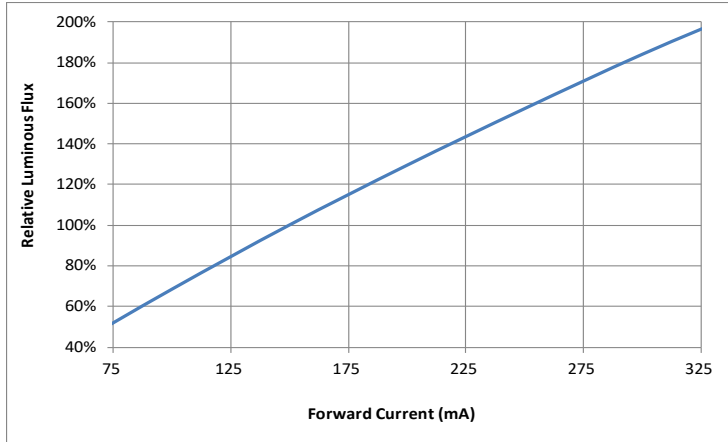
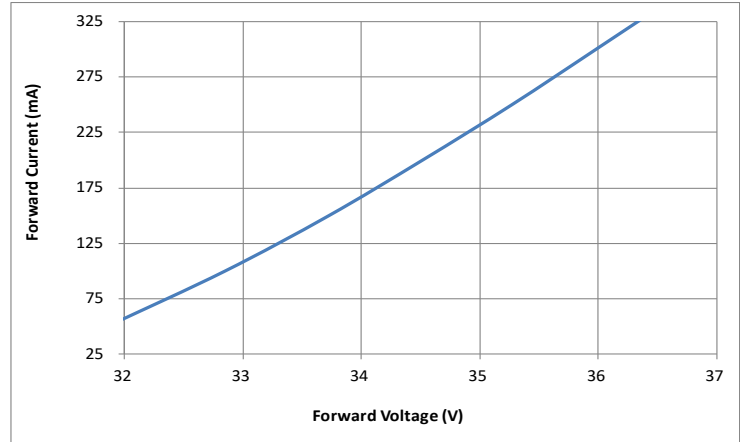
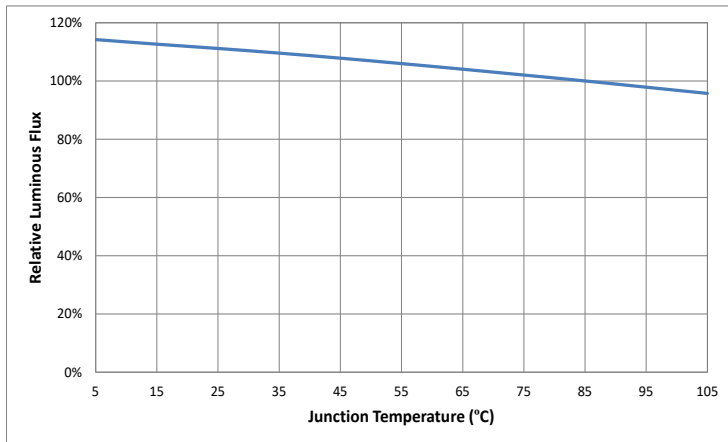
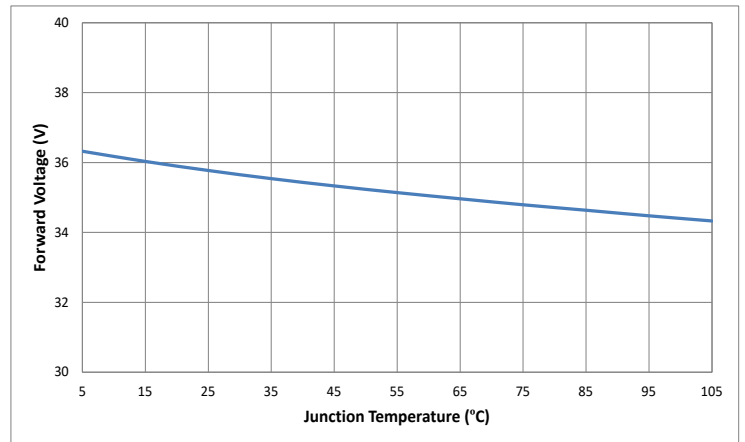
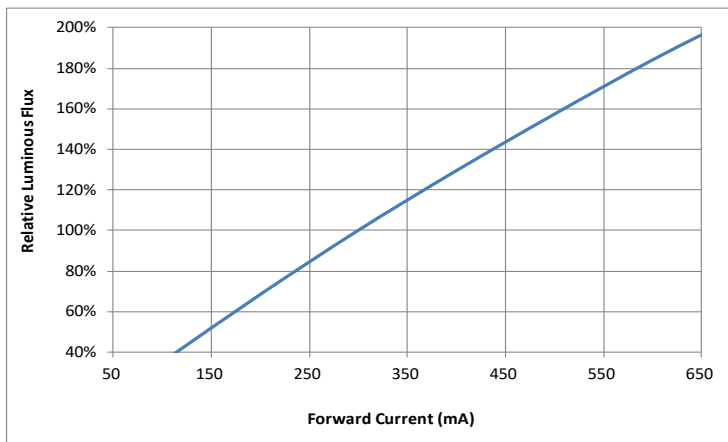
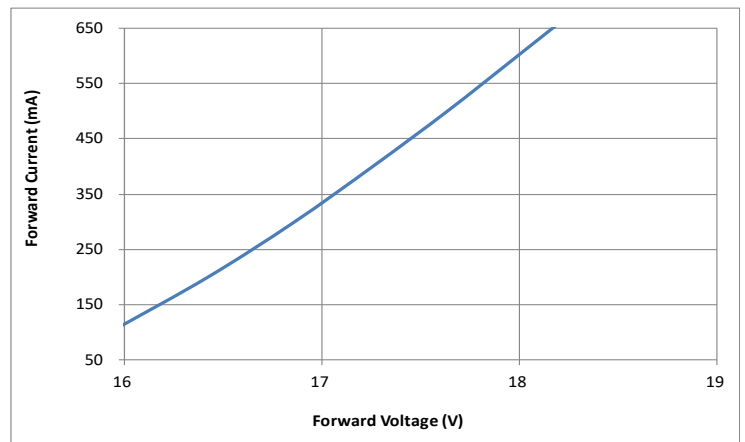
36V Optical & Electrical Characteristics
Relative Output Flux vs. Forward Current @ 85°C

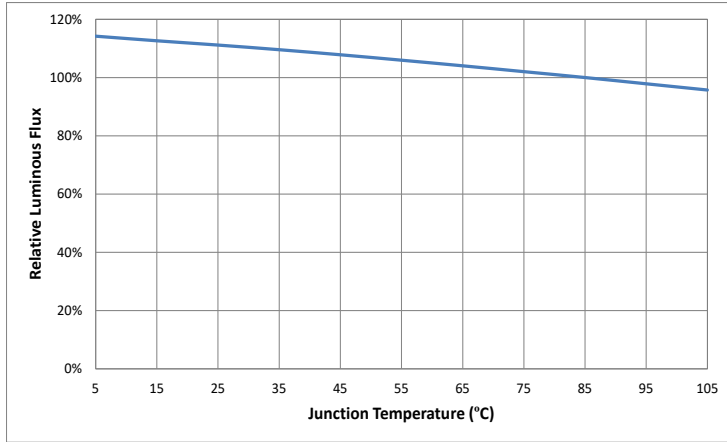
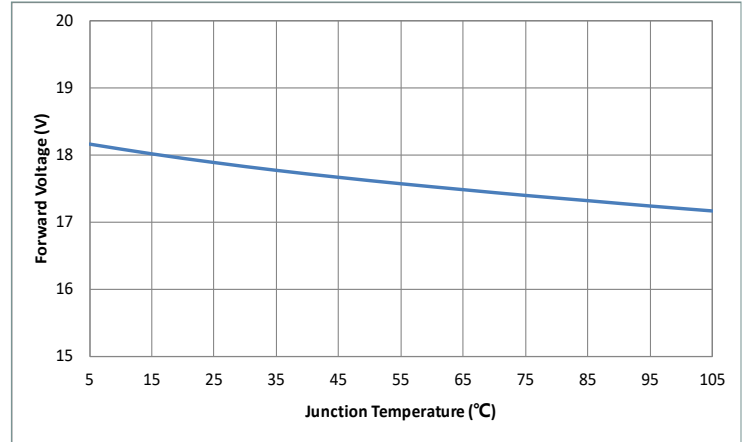
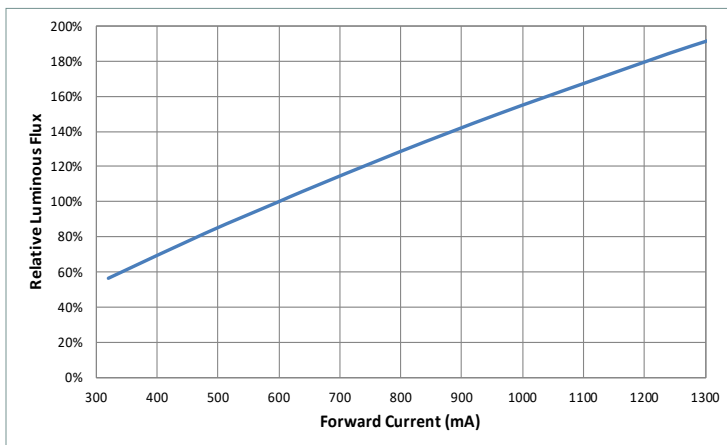
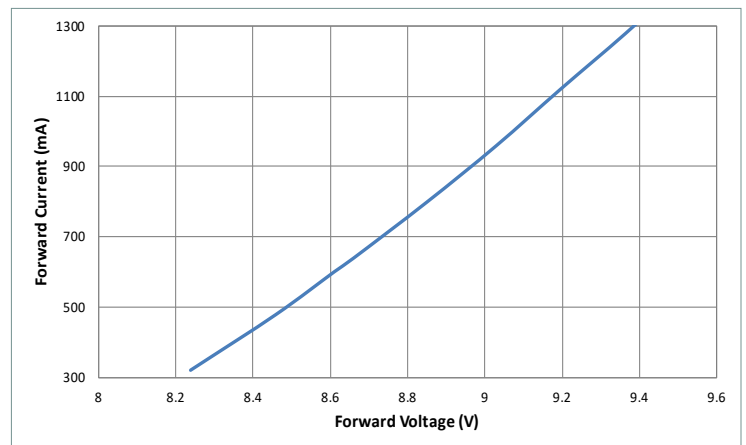
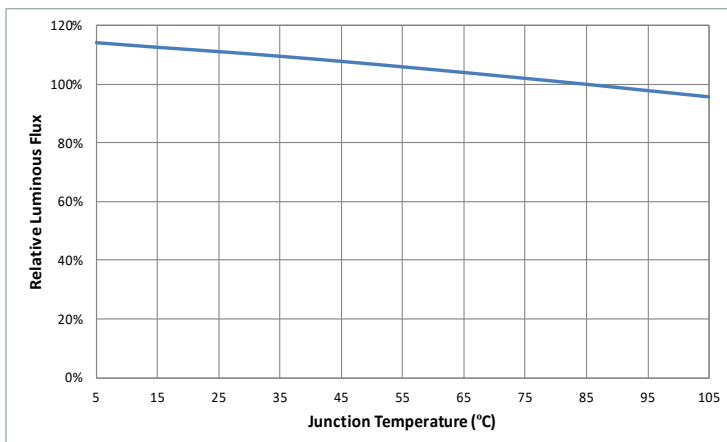
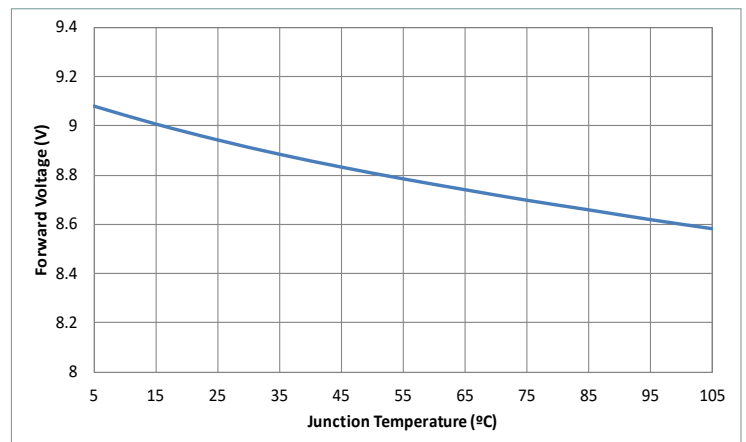
Forward Current vs. Forward Voltage @ 85°C

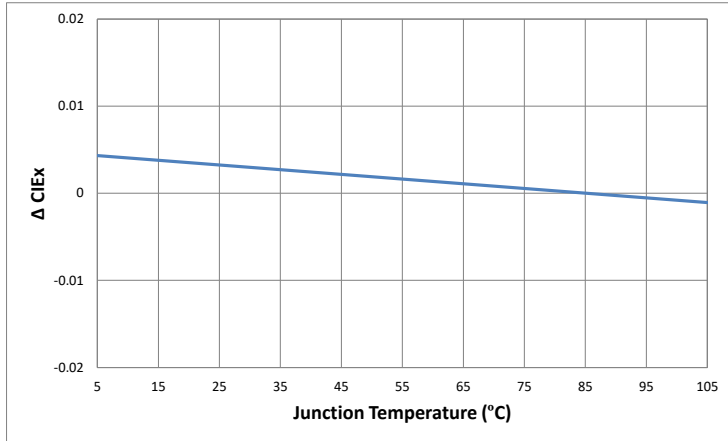
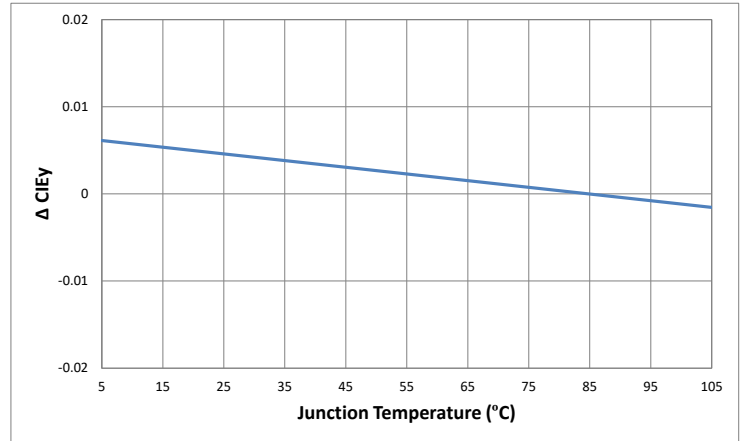
Relative Output Flux vs. Junction Temperature

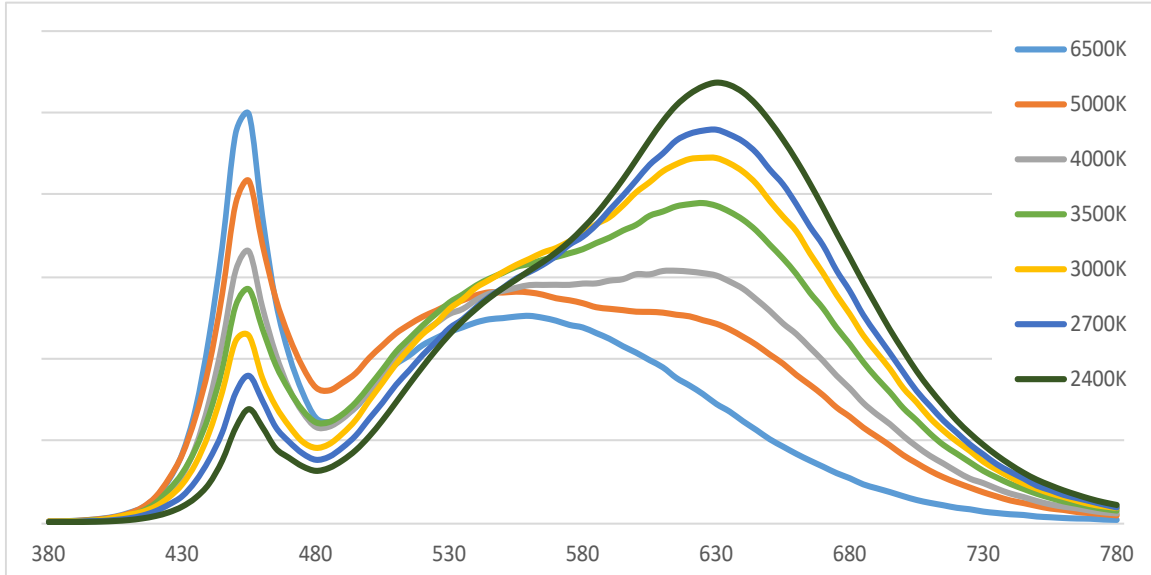
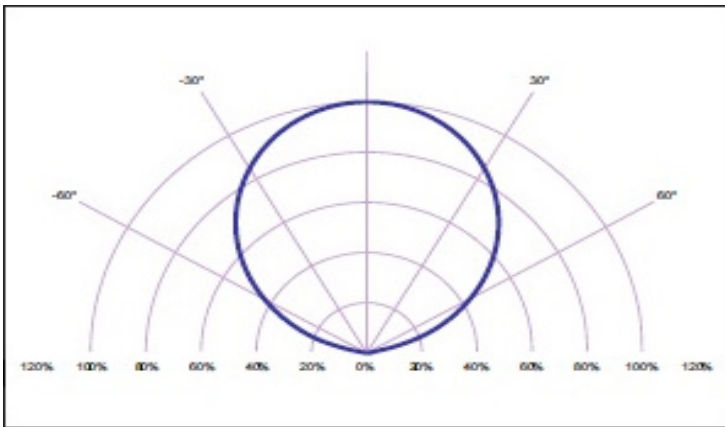
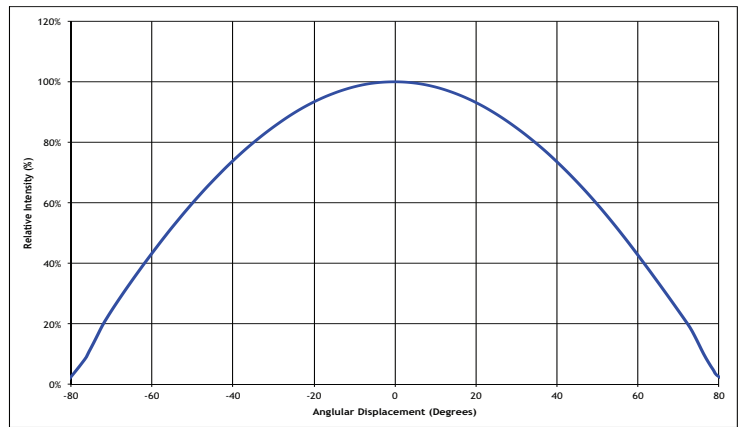
Change in Voltage vs. Junction Temperature

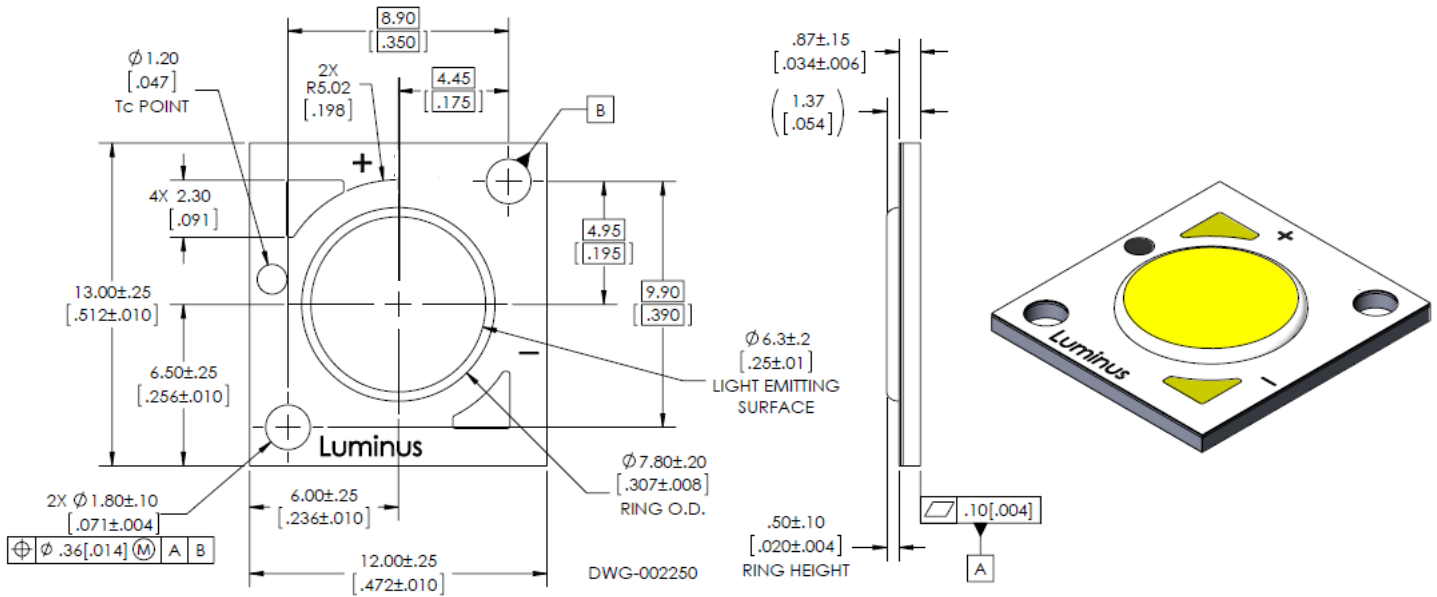
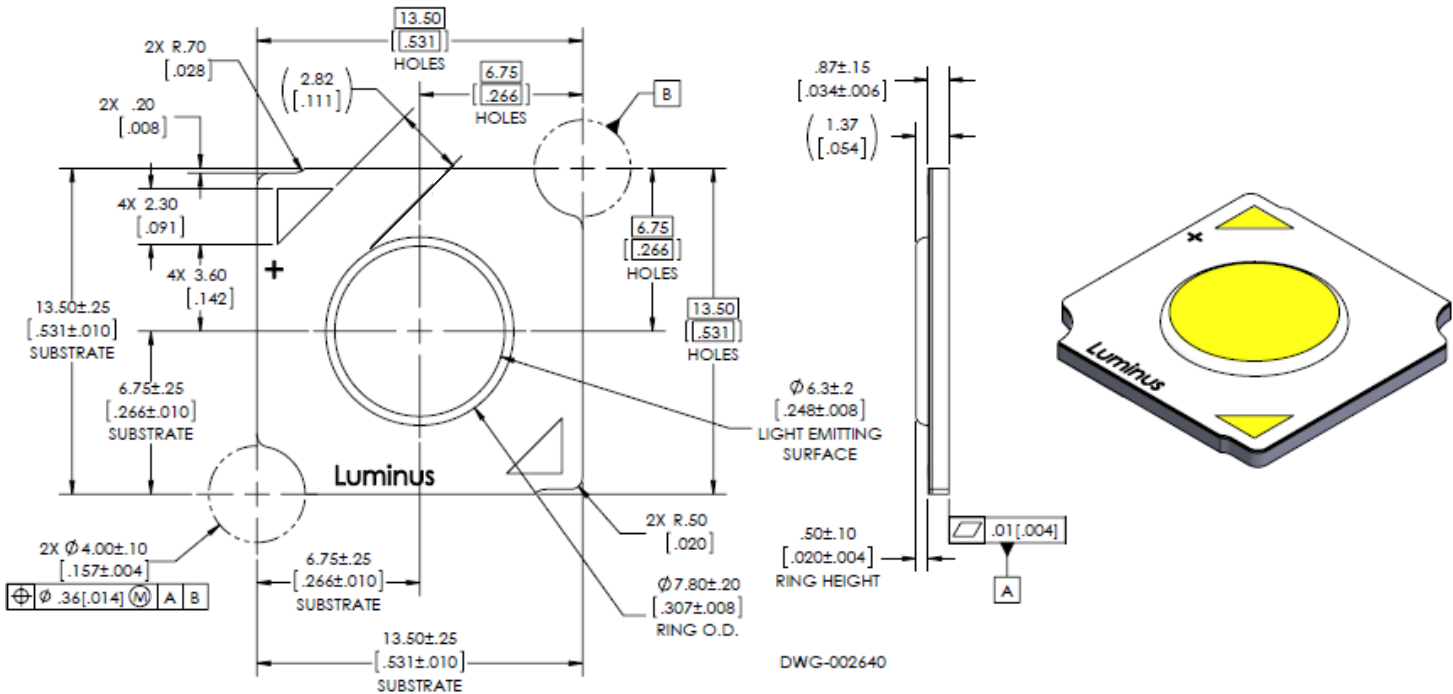
18V Optical & Electrical Characteristics
Relative Output Flux vs. Forward Current @ 85°C

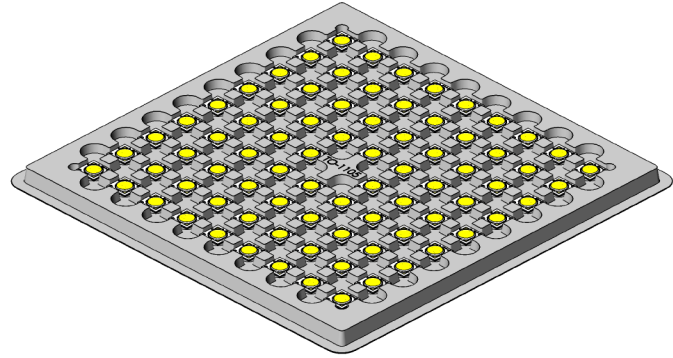
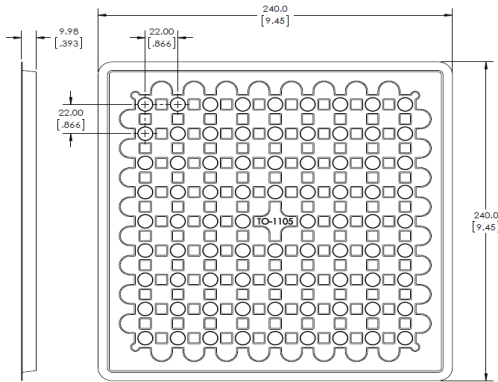
Forward Current vs. Forward Voltage @ 85°C

18V Optical & Electrical Characteristics
Relative Output Flux vs. Junction Temperature

Change in Voltage vs. Junction Temperature

9V Optical & Electrical Characteristics
Relative Output Flux vs. Forward Current @ 85°C

Forward Current vs. Forward Voltage @ 85°C

Relative Output Flux vs. Junction Temperature

Change in Voltage vs. Junction Temperature

Change in CIE_x vs. Junction Temp. (3000K, 80CRI)

Change in CIE_y vs. Junction Temp. (3000K, 80CRI)

Optical & Electrical Characteristics
Typical Spectrum

Typical Polar Radiation Pattern

Typical Angular Radiation Pattern

Mechanical Dimensions (CXM-6-AA30)

Mechanical Dimensions (CXM-6-AC30)

Shipping Container (CXM-6-AA/AC30)

400 pcs per box
Each bag is boxed for easier storage/ stacking

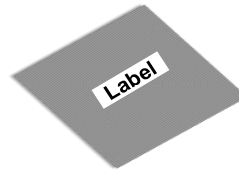

Trays are sealed in an anti-static bag



80 pcs per tray
5 trays are stacked together with separate cover

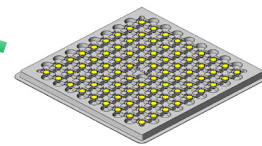

Luminus Label Model:

		Luminus Devices Inc		RoHS Compliant
XXXXXX-XX-XX (Manufacturer Part Number & Bin Kits)		Rev XX		
<input type="text" value="Bar code"/>		<input type="text" value="Bar code"/>		
XXX-XX-XX-XX-XX-XXXX-XX-X (Customer Part Number)				
XXXXXXXXXXXXXXX (Box ID)		Qty: XX		
<input type="text" value="Bar code"/>		<input type="text" value="Bar code"/>		

Handling Notes for Luminus COBs

Luminus products are designed for robust performance in general lighting application. However, care must be taken when handling and assembling the LEDs into their fixtures. To avoid damaging Luminus COBs please follow these guidelines.

The following is an overview of the application notes detailing some of the practices to follow when working with these devices. More detailed information is available on the Luminus web site at www.luminus.com.

General Handling

Devices are made to be lifted or carried with tweezers on two adjacent corners opposite the contact pads. At no time should the devices be handled by or should anything come in contact with the light emitting surface (LES) area. This area includes the yellow colored circular area and the ring surrounding it. There are electrical connections under the LES which if damaged will cause the device to fail.

In addition, the ring frame itself should not be used for moving, lifting or carrying the device. Also do not attach any optics or mechanical holders to the ring as it is not capable to handle the mechanical stress.

Static Electricity

Luminus COBs are electronic devices which can be damaged by electrostatic discharge (ESD). Please use appropriate measures to assure the devices do not experience ESD during their handling and or storage. ESD protection guidelines should be used at all times when working with Luminus COBs.

Storage: Luminus products are delivered in ESD shielded bags and should be stored in these bags until used.

Assembly: Individuals handling Luminus COBs during assembly should be trained in ESD protection practices. Assemblers should maintain constant conductive contact with a path to ground by means of a wrist strap, ankle straps, mat or other ESD protection system.

Transporting: When transporting the devices from one assembly area to another, ESD shielded carts and carriers should be used.

Electrical Contact

Luminus COBs are designed with contact pads on their top surface. These pads are clearly marked with + and – polarity. Wires can be soldered to the contact pads for electrical connections or other solderless connector products are available.

If wires are being soldered to the COB product, we recommend attaching these wires prior to mounting the devices to a heat sink. Please contact Luminus for specific recommendations on how to solder wires if not familiar with the standard practice. Luminus can also offer design recommendations for jigs to allow easily soldering multiple products in rapid succession.

Chemical Compatibility

The resin material used to form the LES can get hydrocarbons from the surrounding environment. As a result, certain chemical compounds are not recommended for use with the Luminus products. Use of these compounds can cause damage to the light output of the device and may permanently damage the device. Please refer to www.luminus.com for a list of the compounds not recommended for use with the Luminus COB products.

Thermal Interface Material (TIM)

Proper thermal management is critical for successful operation of any LED system. Excess operating temperature can reduce the light output of the device. And excessive heating can cause permanent damage to the device. Proper TIM material is a crucial component for effective heat transfer away from the LED during normal operation. Please refer to www.luminus.com for specific recommendations for TIM solutions.



Компания «ЭлектроПласт» предлагает заключение долгосрочных отношений при поставках импортных электронных компонентов на взаимовыгодных условиях!

Наши преимущества:

- Оперативные поставки широкого спектра электронных компонентов отечественного и импортного производства напрямую от производителей и с крупнейших мировых складов;
- Поставка более 17-ти миллионов наименований электронных компонентов;
- Поставка сложных, дефицитных, либо снятых с производства позиций;
- Оперативные сроки поставки под заказ (от 5 рабочих дней);
- Экспресс доставка в любую точку России;
- Техническая поддержка проекта, помощь в подборе аналогов, поставка прототипов;
- Система менеджмента качества сертифицирована по Международному стандарту ISO 9001;
- Лицензия ФСБ на осуществление работ с использованием сведений, составляющих государственную тайну;
- Поставка специализированных компонентов (Xilinx, Altera, Analog Devices, Intersil, Interpoint, Microsemi, Aeroflex, Peregrine, Syfer, Eurofarad, Texas Instrument, Miteq, Cobham, E2V, MA-COM, Hittite, Mini-Circuits, General Dynamics и др.);

Помимо этого, одним из направлений компании «ЭлектроПласт» является направление «Источники питания». Мы предлагаем Вам помощь Конструкторского отдела:

- Подбор оптимального решения, техническое обоснование при выборе компонента;
- Подбор аналогов;
- Консультации по применению компонента;
- Поставка образцов и прототипов;
- Техническая поддержка проекта;
- Защита от снятия компонента с производства.



Как с нами связаться

Телефон: 8 (812) 309 58 32 (многоканальный)

Факс: 8 (812) 320-02-42

Электронная почта: org@eplast1.ru

Адрес: 198099, г. Санкт-Петербург, ул. Калинина, дом 2, корпус 4, литера А.