



EDAC GROUP



A world class manufacturer of high quality electronic connectors
with offices in

Canada
United States
England
Taiwan
China

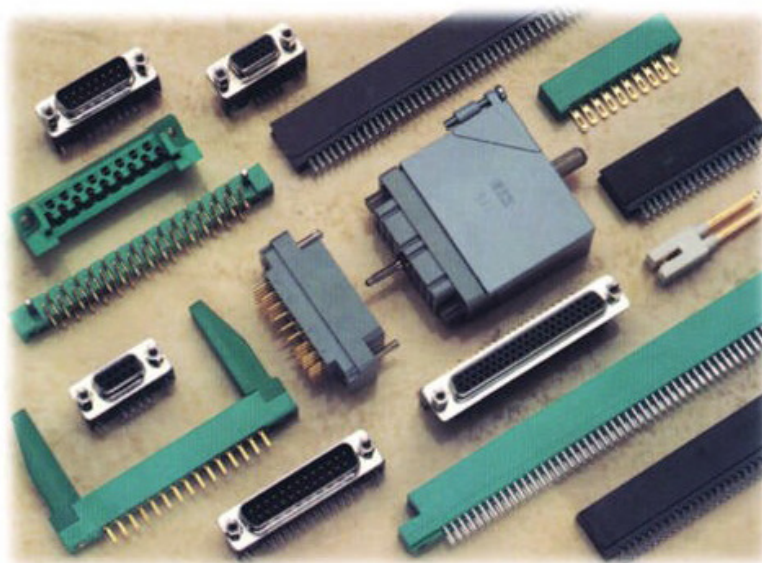

EDAC components are available through a worldwide network of
Distributors and Manufacturers Representatives

For the contact name and number of an EDAC representative in your area
please refer to our web site at

<http://www.edac.net>

Our policy is to ship error free parts, on time at competitive price

EDAC

GROUP

| NUMERICAL INDEX | | | | TABLE OF CONTENTS | |
|-----------------|------|---------------|------|---------------------------------------|-----------|
| Series | Page | Series | Page | Section | Page |
| 100 | 73 | 345 Guide | 66 | Introduction | 0 |
| 103 | 73 | 345 Tools | 72 | Connector Applications | 1 |
| 105 | 73 | 346 | 29 | Engineering and General Notes | 3 |
| 106 | 73 | 346 Guide | 66 | | |
| 205 | 72 | 349 | 57 | | |
| 206 | 72 | 355 | 31 | | |
| 207 | 72 | 356 | 33 | | |
| 237 | 72 | 357 | 35 | | |
| 241 | 72 | 368 | 53 | | |
| 243 | 59 | 368 Guide | 65 | Compliant Pin Card | |
| 243 Guide | 65 | 379 | 55 | Edge Press Fit Connector Group | 5 |
| 245 | 72 | 384 | 58 | .100" (2.54mm) Contact Spacing | 7 |
| 246 | 72 | 387 | 37 | .125" (3.18mm) Contact Spacing | 9 |
| 301 | 14 | 389 | 27 | .156" (3.96mm) Contact Spacing | 11 |
| 302 | 15 | 391 | 19 | .100" (2.54mm) 98 Pin-AT Style | 13 |
| 303 | 39 | 392 | 21 | Compliant Connector Tools | 6 |
| 305 | 31 | 395 | 17 | | |
| 306 | 33 | 395 98 Pin-AT | 23 | Card Edge Connector Group | 14 |
| 307 | 35 | 396 | 29 | .050" (1.27mm) Contact Spacing | 14 |
| 307 Guide | 66 | 399 | 72 | .100" (2.54mm) Contact Spacing | 17 |
| 308 | 72 | 408 | 77 | .100" (2.54mm) 98 Pin-AT Style | 23 |
| 310 | 49 | 415 | 79 | .100" (2.54mm) Bellows | 27 |
| 315 | 31 | 417 | 81 | .125" (3.18mm) Contact Spacing | 29 |
| 316 | 33 | 418 | 83 | .156" (3.96mm) Contact Spacing | 31 |
| 317 | 41 | 421 | 75 | .150" (3.81mm) Contact Spacing | 55 |
| 317 Guide | 66 | 422 | 75 | .200" (5.08mm) Contact Spacing | 59 |
| 321 | 50 | 423 | 75 | Additional Series, Tools | 72 |
| 322 | 51 | 424 | 77 | High Temperature Options | 60 |
| 323 | 52 | 438 | 79 | Contact Bend Details | 61 |
| 324 | 72 | 516 | 85 | Mounting Option Details | 63 |
| 325 | 25 | 516 Cover | 88 | Card Guides, Uniguides | 66 |
| 327 | 54 | 516 Shield | 89 | Dimension Charts | 67 |
| 330 | 72 | 519 | 93 | | |
| 333 | 43 | 556 | 95 | | |
| 334 | 72 | 616 Guide | 66 | Edacon Two Piece Connector | |
| 336 | 45 | 737 | 11 | Group | 73 |
| 337 | 37 | 737 Tools | 6 | Loose Contacts & Contact Strips | 73 |
| 338 | 47 | 745 | 7 | Metal to Metal (Board to Board) | 75 |
| 339 | 27 | 745 98 Pin-AT | 13 | Rack & Panel Connectors | 85 |
| 340 | 24 | 745 Tools | 6 | Rack & Panel Covers | 88 |
| 341 | 19 | 746 | 9 | 3 to 6 Position Plug & Receptacle | 95 |
| 342 | 21 | 746 Tools | 6 | | |
| 345 | 17 | 800 Series | 60 | | |
| 345 Guide | 66 | | | Your Connection to Quality | |
| | | | | and Service | |

CONNECTOR APPLICATIONS

Edac connectors are used around the world in a wide variety of applications. The Edac product line includes a broad range of card edge connectors together with rack & panel and metal to metal interconnect systems, application tooling and card guide components.

INDUSTRIES SERVICED BY EDAC

- Computer (mainframes, personal, terminals and peripheral equipment)
- Broadcast & Motion Picture (studio equipment, interconnect cabling)
- Consumer Electronics (video and arcade games, interactive toys)
- Military Electronics (weapons systems)
- Aviation Electronics (ground based radar, test equipment)
- Telecommunications (central office, PBX and electronic key systems)
- Industrial Electronics (controllers, monitoring systems)
- Test Equipment (general and special purpose instruments and systems)
- Traffic Control (highway safety and monitoring systems)

CARD EDGE CONNECTORS

The most common application for card edge connectors involves the use of printed circuit daughter boards. The connectors are frequently mounted within an enclosure and interconnected using either a printed circuit mother board (backplane), wire wrap technology or hand wiring.

Edac supplies connectors in a variety of row spacings and contact pitches suitable for motherboard and wire wrap applications. The backplane connectors are available in either solder dip or compliant (non-solder press fit) configurations.

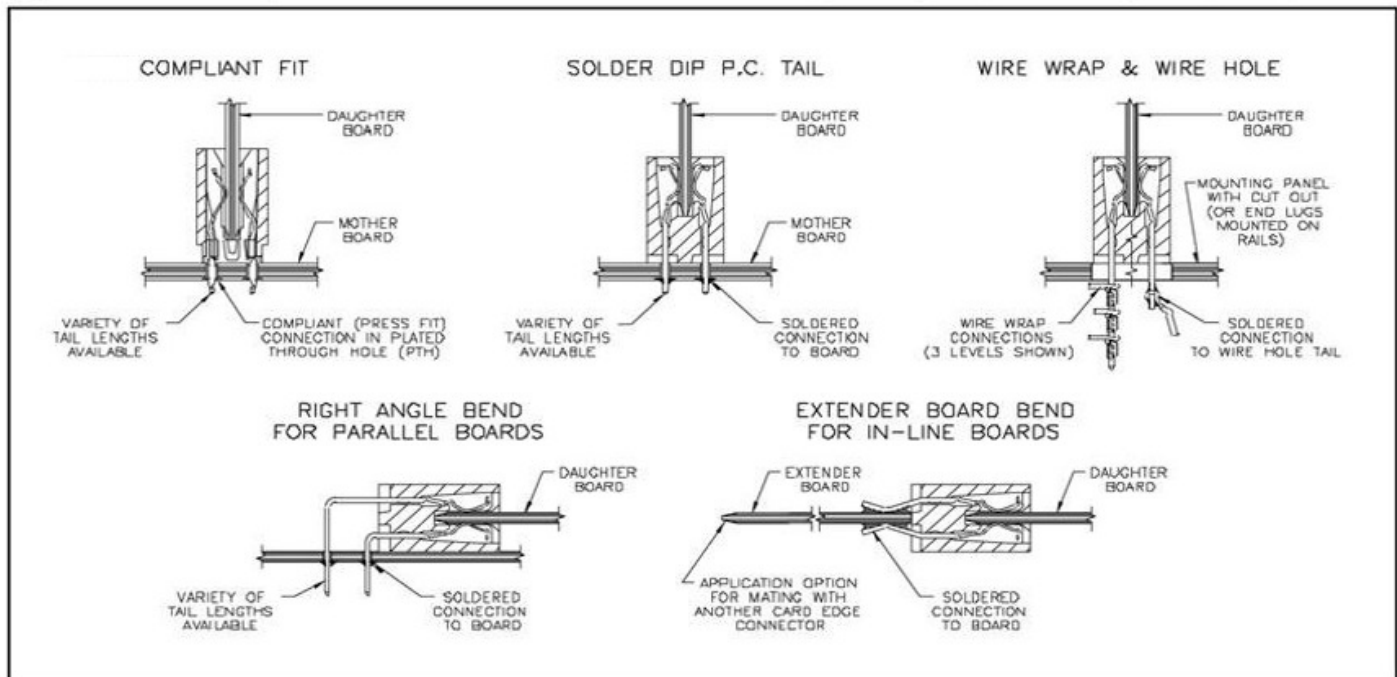

Edac connectors can be designed into many of the industry standard bus systems. For your convenience, the following chart may be used as a guide.

| BUS SYSTEM | CONNECTOR SPECIFICATION | EDAC SERIES | BUS SYSTEM | CONNECTOR SPECIFICATION | EDAC SERIES |
|------------------|------------------------------------|--------------|--------------------|------------------------------------|--------------|
| APPLEBUS | 2 x 25 Pin, .100" (2.54mm) Spacing | 345, 50 Pin | MOTOROLA EXERCISOR | 2 x 43 Pin, .156" (3.96mm) Spacing | 337, 86 Pin |
| EISA | 2 x 94 Pin, .050" (1.27mm) Spacing | 301, 188 Pin | MULTIBUS 1 | 2 x 43 Pin, .156" (3.96mm) Spacing | 337, 86 Pin |
| IBM PC-XT | 2 x 31 Pin, .100" (2.54mm) Spacing | 345, 62 Pin | | 2 x 30 Pin, .100" (2.54mm) Spacing | 345, 60 Pin |
| IBM PC-AT(ISA) | 2 x 49 Pin, .100" (2.54mm) Spacing | 395, 98 Pin | STANDARD BUS | 2 x 28 Pin, .125" (3.18mm) Spacing | 346, 56 Pin |
| IBM MICROCHANNEL | 2 x 56 Pin, .050" (1.27mm) Spacing | 302, 112 Pin | S100 | 2 x 50 Pin, .125" (3.18mm) Spacing | 346, 100 Pin |
| | 2 x 66 Pin, .050" (1.27mm) Spacing | 302, 132 Pin | VERSABUS | 2 x 70 Pin, .100" (2.54mm) Spacing | 345, 140 Pin |
| | 2 x 91 Pin, .050" (1.27mm) Spacing | 302, 182 Pin | | 2 x 60 Pin, .100" (2.54mm) Spacing | 345, 120 Pin |

CONNECTOR APPLICATIONS

METAL TO METAL AND RACK & PANEL CONNECTORS

When ultra reliable interconnections are required, use of our metal to metal contact system is suggested. Either standard sized connectors can be specified, or a customer's own contact pattern can be accommodated using individual components mounted directly to the printed circuit board. The principle of the Edacon metal to metal contact is shown below.

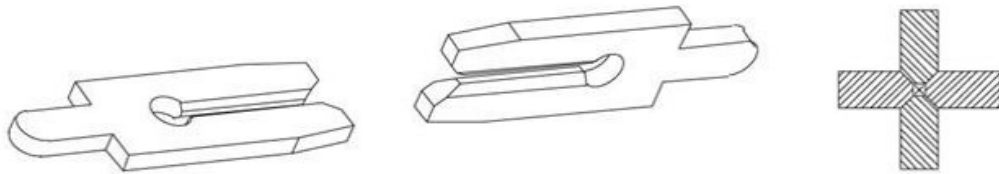

Edacon
Hermaphroditic
Contact Design
with
Four Contact
Mating Surfaces

Typical arrangements for metal to metal interconnect systems.

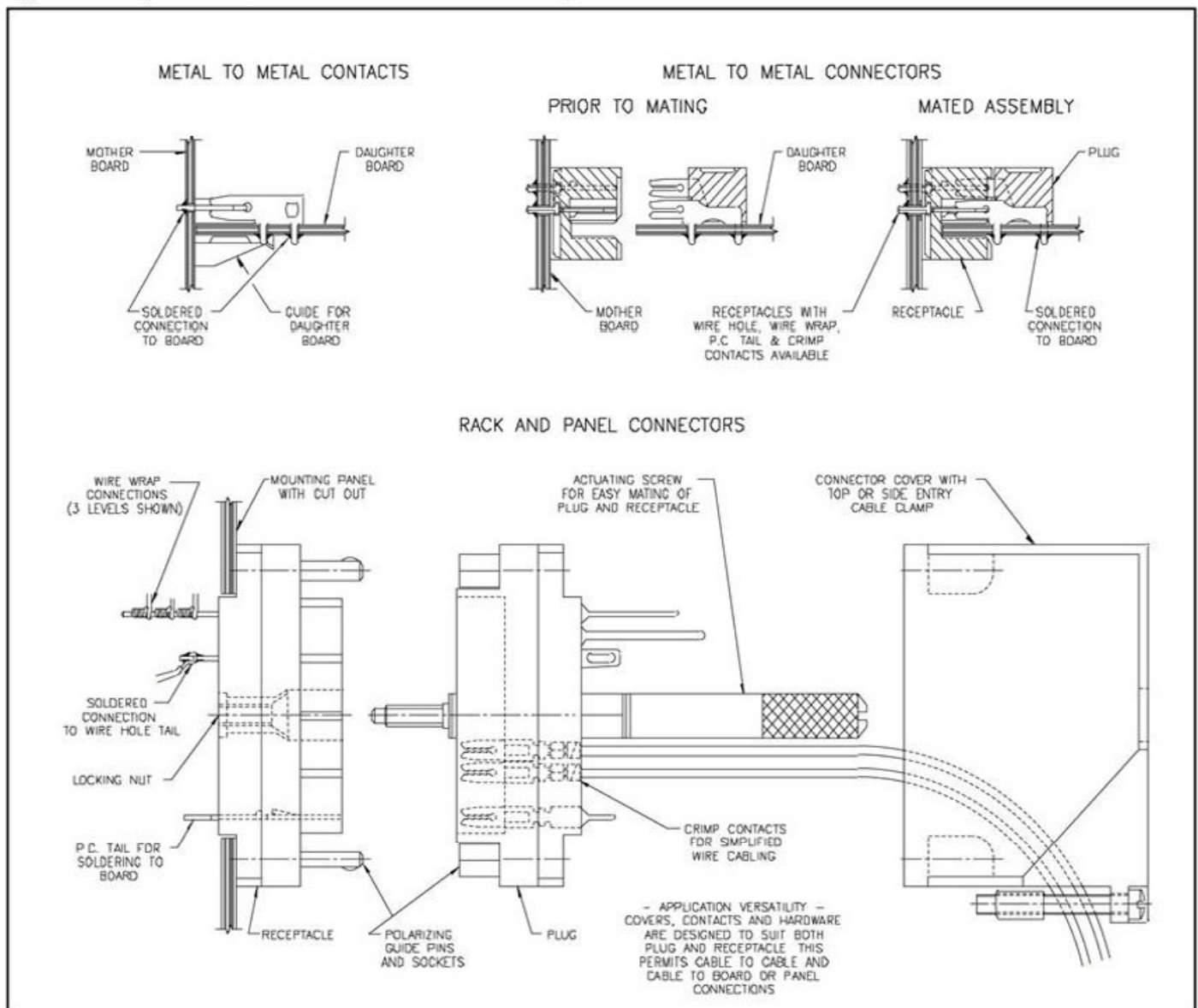

SPECIAL APPLICATIONS

Edac specializes in providing many customized connectors for both small and large orders. If you need a special card slot, body width, card guide, contact tail, mounting option, etc. then call the factory for a quotation. Our tooling system allows us to manufacture many non-standard options at a low cost.

ENGINEERING NOTES

Plastic Moulding Materials

Edac offers a wide range of insulator materials including polyester, diallyl phthalate, polyphenylene sulphide, polycarbonate and nylon. Card guides are moulded in polyester or polycarbonate and polarizing keys are moulded in nylon. If a specific material is required to suit your application, please consult with Edac.

All of the moulding materials used by Edac have excellent mechanical, electrical and thermal properties. Some of the notable differences between the material characteristics are as follows:

- 1) Diallyl phthalate is a thermoset material. All other materials used are thermoplastics.
- 2) Polyphenylene sulphide and diallyl phthalate are capable of being used in vapour phase or infra-red soldering applications up to 260 degc. Frequently these materials are also used in burn-in applications up to 150 degrees Celsius.
- 3) In general, chemical resistance is excellent for all of the materials, except polycarbonate. With polycarbonate, chemicals such as amines, aromatic or halogenated hydrocarbons, esters and ketones should be avoided.
- 4) The flammability rating is UL 94V-0 for all materials, except for polycarbonate which is rated at UL 94V-2 and nylon which is rated at UL 94HB.

Contact Materials

Contact base materials are copper alloy.

Contact Finish

The standard contact finishes offered include:

- 1) Selective plating - nickel overall followed by gold on the contact mating area and tin alloy on the contact tails
- 2) Overall plating - gold over nickel or tin alloy

With this manufacturing flexibility, Edac can also provide contact finishes to meet specific requirements. Examples of special platings regularly performed include various plating thicknesses and selectively plated gold on both the mating area and the contact tail.

Metal Hardware Materials

The majority of metal hardware such as threaded inserts, bushings and actuating screws are nickel plated brass or steel. Consult with Edac if specific details are required.

Underwriters Laboratories (UL) and Canadian Standard Association (CSA)

Connectors recognized by UL and certified by CSA (as indicated on the individual series pages) are listed under UL File No. E62838 & E215269 and CSA File No. LR 39927. Consult with Edac if additional product listings are required.

Wire Data

Diameters of wire sizes commonly used with Edac connectors are summarized below. The actual stranded wire diameter is dependant upon the number of strands and individual strand gauge.

| Gauge AWG | Diameter of Solid Wire Conductor | Diameter of Stranded Wire Conductor |
|--------------|--|---|
| 18 | .0403 (1.024) | .047 to .049 (1.19 to 1.24) |
| 20 | .0320 (0.813) | .035 to .038 (0.89 to 0.97) |
| 22 | .0253 (0.643) | .030 to .031 (0.76 to 0.79) |
| 24 | .0201 (0.511) | .023 to .024 (0.58 to 0.61) |
| 26 | .0159 (0.404) | .019 to .021 (0.48 to 0.53) |
| 28 | .0126 (0.320) | .015 to .016 (0.38 to 0.41) |
| 30 | .0100 (0.254) | .012 (0.30) |

The insulation diameter will vary depending upon the application, rating and material.

ENGINEERING & GENERAL NOTES

ENGINEERING NOTES

Special Variation Connectors

Over the past 40 years, Edac has manufactured a wide selection of special connectors. In the part numbering system, they are identified as special by the last group of digits in the part number.

Example Part Number 345 - 072 - 520 - 3 05

Special Variation Identification Code
No. 3 - for Series 100 to 438
No. 9 - for Series 516 to 746

Unique Listing Code for Special Connector
This number is assigned by Edac. Note that connector part number 345-060-520-305 may have completely different features than the part number in the example above.

Some examples of special connector features previously used in manufacturing include:

- Special contact assembly patterns
- Polarizing key installed or moulded into position
- Cost saving options such as no part marking
- Material and plating options
- Special insulator dimensions (length, width, height, mounting)
- Insulator features such as open card slot ends
- Special contact bends, board lock forms, tail lengths
- Customer part number marking
- Specific quality requirements or testing
- Specific control on insertion and withdrawal forces
- Mounting features such as side holes through card guides
- Special rack & panel polarization or cover designs

If you have any unique or unusual connector requirements, discuss them with the specialists at Edac, where even the strangest design ideas can become reality.

Environmental Responsibility

Edac's products and manufacturing processes are free of ozone depleting substances (CFC's and HCFC's) as listed by the Environmental Protection Agency. In addition, waste water quality management and 3R (reduce, re-use and recycle) programs form part of the Edac commitment to environmental responsibility.

GENERAL NOTES

- 1) Unless indicated otherwise, all dimensions are in inches with the millimeter equivalent in parenthesis, for example .125 (3.18).
- 2) Some helpful unit conversion factors are as follows:
1.000 inch = 25.40 millimeters
.000001 inch = 1 microinch = 0.0254 microns
16 ounces force = 1 pound force = 4.448 Newtons
- 3) Dimensional drawings are presented using orthographic third angle projection.
- 4) Abbreviations used in this catalogue are summarized below:

| | |
|------|---|
| AWG | - American Wire Gauge |
| C | - Celcius |
| CSA | - Canadian Standards Association |
| Dia. | - Diameter |
| EISA | - Extended Industry Standard Architecture |
| I.D. | - Inside Diameter |
| ISA | - Industry Standard Architecture |
| kN | - kilonewton |
| kPa | - kilopascal |
| lbs | - pounds |
| MCA | - Microchannel Architecture |
| mm | - millimeters |
| N | - newton |
| oz | - ounce |
| P.C. | - Printed Circuit |
| P/N | - Part Number |
| psi | - pounds per square inch |
| rms | - root mean squared |
| V AC | - Volts, Alternating Current |
| UL | - Underwriters Laboratories |
- 5) Registered trademarks to be acknowledged include:
Wire Wrap - Gardner Denver Corp.
- 6) Edac is a licensed user of the connector design technology that permits the use of flat rock tooling for the installation of the compliant pin card edge connectors.
- 7) Every effort has been made to ensure the accuracy of information within this catalogue. When changes or corrections are necessary, trade announcements are made to customers, distributors or representatives of Edac. Readers of this catalogue are invited to offer suggestions for improvements to future publications.

700 SERIES GROUP

Compliant Pin Card Edge Connectors

Contact Spacings of .100 (2.54), .125 (3.18) and .156 (3.96)

Full Range of Connector Sizes - Up to 150 Contacts

Variety of Contact Tail Lengths and Contact Point Styles

Make-Before-Break Switching Contacts also Available

Simple Flat Rock Tooling for Connector Installation

Unique Compliant Pin Design offers Low Installation Force, Symmetrical Internal Force Distribution, a Large Uniform Compliant Surface Area and will Cause No Damage to the Circuit Board Holes

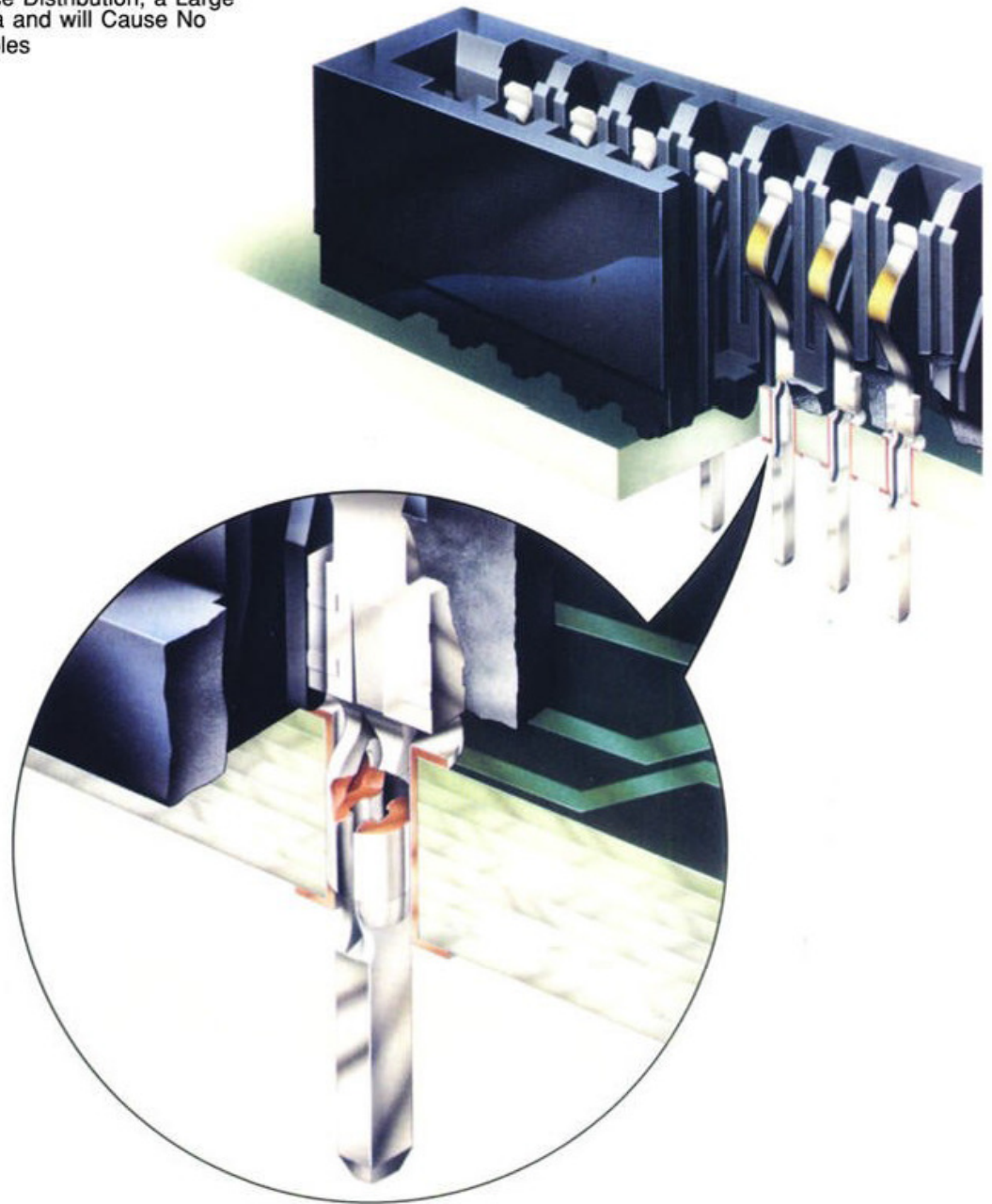

PRESS FIT CARD EDGE CONNECTOR TOOLS

Compliant Pin Connector Installation, Contact and Insulator Removal

CONNECTOR INSTALLATION

Connectors received by the customer are ready for installation into the circuit board. The flat rock insertion technique requires a press and adequate support for the circuit board. Once the number of contacts to be pressed into the board together has been determined, the press tonnage should be calculated at approximately 30 pounds (134 N) per contact. The support plate should be designed with clearance where the contact tails protrude through the underside of the board.

INSULATION REMOVAL TOOL

Part Number 745-280-200 for Use with 737 and 745 Series Connectors

Part Number 746-280-200 for Use with 746 Series Connectors
Tool Latches under Side Steps of Insulator and Lifts Insulator while Leaving Contacts Firmly Positioned in the Circuit Board

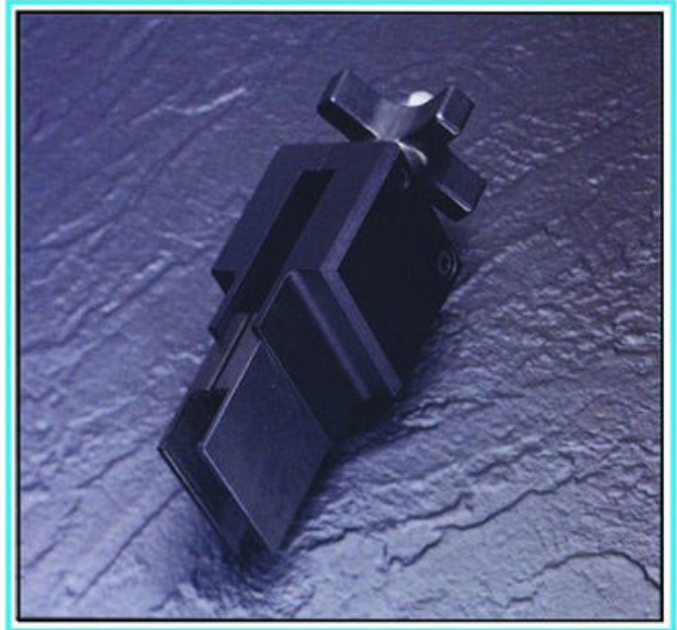

CONTACT REMOVAL TOOL

Part Number 745-280-300 for Contact Codes 520 and 525

Part Number 345-280-200 for All Other Contact Codes
Used for 737, 745 and 746 Series

Removes a Contact from the Circuit Board after the Insulator has been Removed

CONTACT REMOVAL OR REPLACEMENT PROCEDURE

Using the insulator removal tool, lift the insulator up to remove it from the contacts. The contacts will be left standing firmly on the circuit board. Remove any contacts necessary. If replacement contacts are needed, assemble contacts into the appropriate positions in the insulator and push them in lightly so that they will stay in position during re-assembly. Align the insulator with the contacts in the board and push it down until the new contacts are positioned over their holes. Using the flat rock installation technique, push the insulator and new contacts down into their final position.



745 SERIES PRESS FIT CARD EDGE CONNECTOR

.100" (2.54mm) Contact Spacing, Compliant Pin

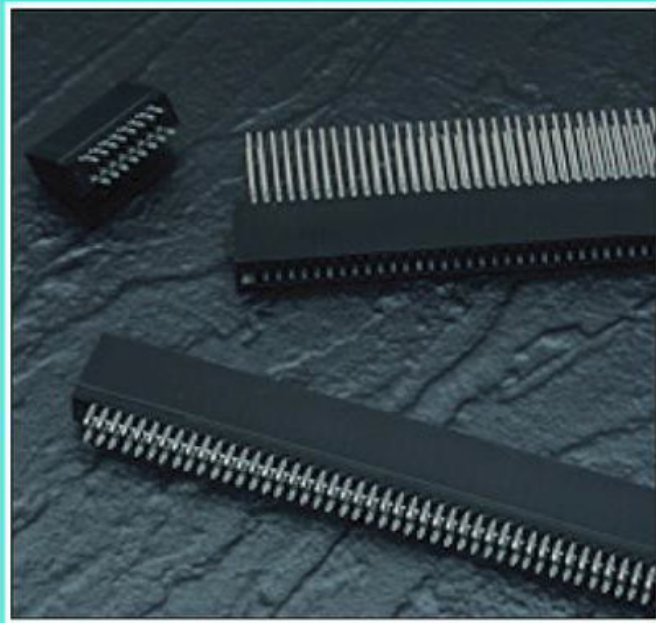

FEATURES

- CSA Approved and UL Recognized
- .100 (2.54) Contact Spacing x .200 (5.08) Row Spacing
- Accepts .062 (1.57) Nominal Thickness P.C. Board
- High Profile Insulator Body, .645 (16.38) with End Notch Option
- **Press Fit Compliant Section for Gas-Tight Reliable Connection in Plated Through Holes Eliminates Soldering Operations**
- Contact Termination Options include P.C. Tail and .025 (0.64) Square Wire Wrap
- Single or Dual Row Configurations
- Accepts Between Contact and In-Contact Polarizing Keys
- Tools Available for Insulator and Contact Removal. Simple "Flat Rock" Tooling is Used for Connector Installation

SPECIFICATIONS

- ◆ Insulator Material: Thermoplastic Polyester, UL 94V-O, Colour: Black
- ◆ **Contact Material: Copper Alloy**
- ◆ Contact Plating: 30 Microinches (0.76 Microns) Gold on the Mating Area, Tin on the Compliant Section and Contact Tails, Nickel Underplate. Other Plating Options Available upon Request.
- ◆ Current Rating: 2 Amperes Continuous
- ◆ Contact Resistance: 10 Milliohms Maximum
- ◆ Dielectric Withstanding Voltage: 1200 V AC rms at Sea Level Between Adjacent Contacts
- ◆ Insulation Resistance: 5000 Megohms Minimum
- ◆ Operating Temperature: -65 to +105 Degrees C
- ◆ Daughter Board Insertion Force: 16 oz (4.45 N) Maximum per Contact Pair when Tested with a .070 (1.78) Thick Gauge
- ◆ Daughter Board Withdrawal Force: 1 oz (0.28 N) Minimum per Contact Pair when Tested with a .054 (1.37) Thick Gauge
- ◆ Contact Insertion Into Hole: 20 lbs (89 N) Maximum
- ◆ Contact Retention In Hole: 10 lbs (44 N) Minimum
- ◆ Re-Insertability of Hole: 3 Times Minimum

745 SERIES ORDERING CODE

Example Part Number **745 - 100 - 520 - 2 06**

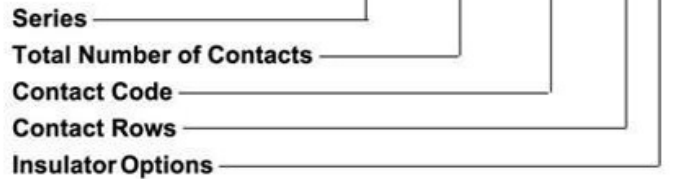

Series 745

| Total Number of Contacts ¹ | Contact Rows |
|---------------------------------------|--------------|
| 005, 006,...075 | Single Row |
| 010, 012,...150 | Dual Row |

| Contact Code ² | Description & Contact Point | Tail Length "G" |
|---------------------------|-----------------------------|-----------------|
| 520 | P.C. Tail Regular Point | .175 (4.45) |
| 522 | P.C. Tail Regular Point | .375 (9.53) |
| 525 | P.C. Tail High Point | .175 (4.45) |
| 540 | Wire Wrap Regular Point | .560 (14.22) |
| 541 | Wire Wrap Regular Point | .750 (19.05) |
| 545 | Wire Wrap High Point | .560 (14.22) |

| Contact Rows | Description |
|--------------|-------------|
| 1 | Single Row |
| 2 | Dual Row |

| Insulator Options | Description |
|-------------------|-------------------------------|
| 01 | .645 (16.38) Full Height Ends |
| 06 | .550 (13.97) Notched Ends |

Ordering Code Notes

- 1) All connector sizes up to 75 contacts single row / 150 contacts dual row are available upon request.
- 2) Make-before-break switching contacts, assembled in specific contact positions, are available upon request.

IN-CONTACT
POLARIZING KEY

P/N 745-240-328



BETWEEN CONTACT
POLARIZING KEY

P/N 306-240-318



PRESS FIT CARD EDGE CONNECTOR SERIES 745

Compliant Pin, Contact Spacing .100" (2.54mm)

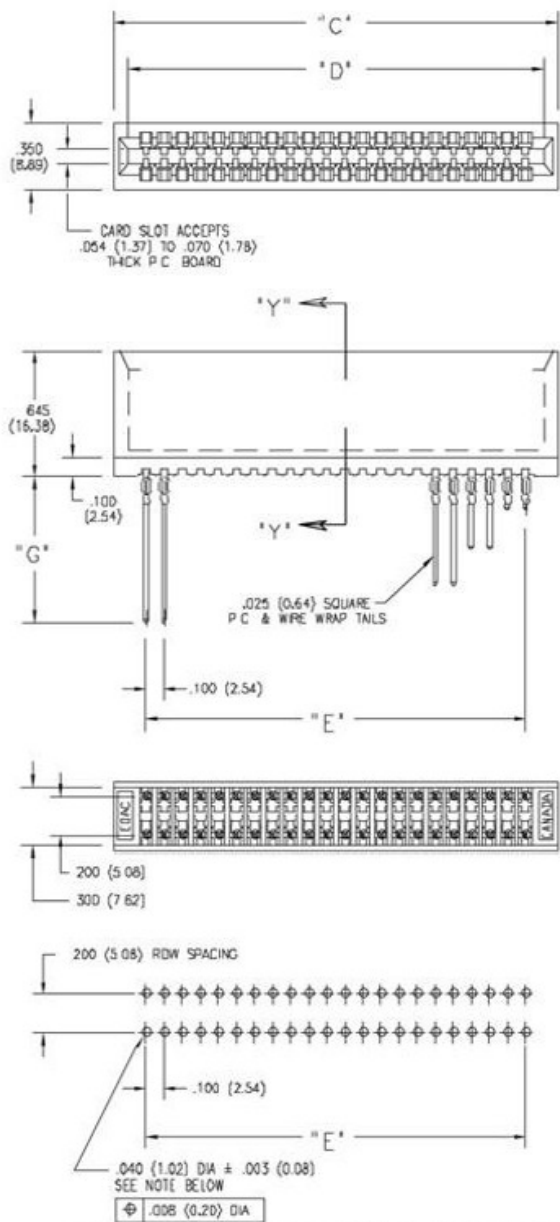

RECOMMENDED MOTHER BOARD HOLE PATTERN

TO OBTAIN OPTIMUM COMPLIANT SECTION PERFORMANCE,
 DRILL HOLES .0453 ± .001 (1.15 ± 0.03) DIAMETER
 COPPER PLATE, .001 (25.4 MICRONS) MINIMUM THICKNESS,
 FOLLOWED BY TIN PLATE TO PROVIDE FINISHED
 HOLES .040 ± .003 (1.02 ± 0.08) DIAMETER.

SECTIONS 'Y' - 'Y'

CONTACT ROWS & INSULATOR OPTIONS

Single Row Versions May Require Backup Springs Dependent upon the Application. Consult with EDAC for Details.

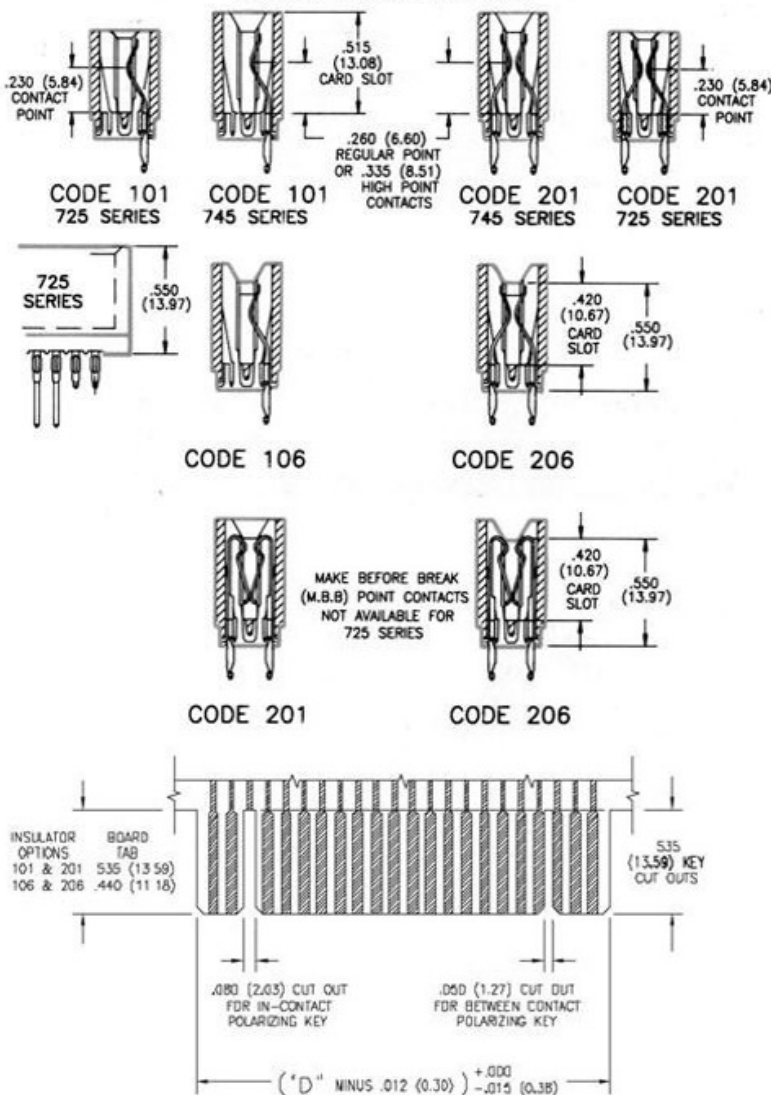

RECOMMENDED DAUGHTER BOARD

| NUMBER OF CONTACTS | | "C" | | "D" | | "E" | |
|--------------------|------|-------|----------|-------|----------|-------|----------|
| Single | Dual | Inch | (mm) | Inch | (mm) | Inch | (mm) |
| 5 | 10 | .760 | (19.30) | .600 | (15.24) | .400 | (10.16) |
| 10 | 20 | 1.260 | (32.00) | 1.100 | (27.94) | .900 | (22.86) |
| 15 | 30 | 1.760 | (44.70) | 1.600 | (40.64) | 1.400 | (35.56) |
| 18 | 36 | 2.060 | (52.32) | 1.900 | (48.26) | 1.700 | (43.18) |
| 22 | 44 | 2.460 | (62.48) | 2.300 | (58.42) | 2.100 | (53.34) |
| 25 | 50 | 2.760 | (70.10) | 2.600 | (66.04) | 2.400 | (60.96) |
| 28 | 56 | 3.060 | (77.72) | 2.900 | (73.66) | 2.700 | (68.58) |
| 30 | 60 | 3.260 | (82.80) | 3.100 | (78.74) | 2.900 | (73.66) |
| 31 | 62 | 3.360 | (85.34) | 3.200 | (81.28) | 3.000 | (76.20) |
| 35 | 70 | 3.760 | (95.50) | 3.600 | (91.44) | 3.400 | (86.36) |
| 36 | 72 | 3.860 | (98.04) | 3.700 | (93.98) | 3.500 | (88.90) |
| 43 | 86 | 4.560 | (115.82) | 4.400 | (111.76) | 4.200 | (106.68) |
| 50 | 100 | 5.260 | (133.60) | 5.100 | (129.54) | 4.900 | (124.46) |
| 75 | 150 | 7.760 | (197.10) | 7.600 | (193.04) | 7.400 | (187.96) |

Dimensions of Other Connector Sizes are Listed

746 SERIES PRESS FIT CARD EDGE CONNECTOR

.125" (3.18mm) Contact Spacing, Compliant Pin

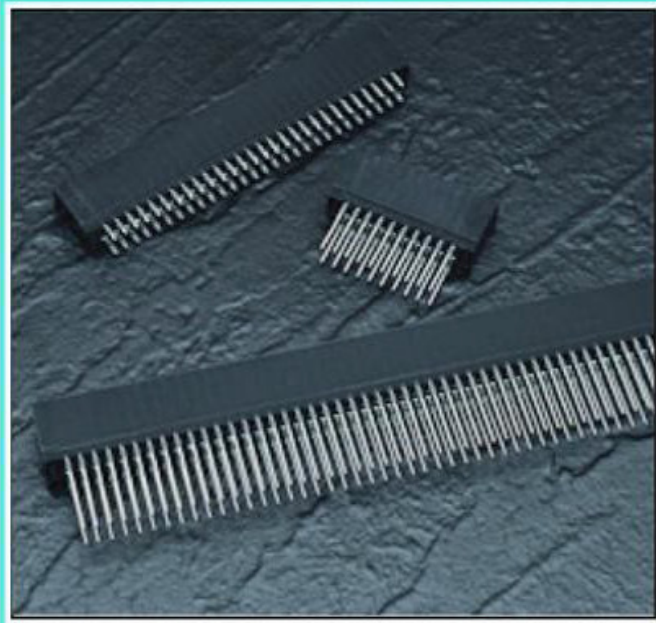

FEATURES

- CSA Approved and UL Recognized
- .125 (3.18) Contact Spacing x .250 (6.35) Row Spacing
- Accepts .062 (1.57) Nominal Thickness P.C. Board
- High Profile Insulator Body, .645 (16.38) with End Notch Option
- **Press Fit Compliant Section for Gas-Tight Reliable Connection in Plated Through Holes Eliminates Soldering Operations**
- Contact Termination Options include P.C. Tail and .025 (0.64) Square Wire Wrap
- Single or Dual Row Configurations
- Accepts Between Contact and In-Contact Polarizing Keys
- Tools Available for Insulator and Contact Removal. Simple "Flat Rock" Tooling is Used for Connector Installation

SPECIFICATIONS

- ◆ Insulator Material: Thermoplastic Polyester, UL 94V-O, Colour: Black
- ◆ **Contact Material: Copper Alloy**
- ◆ Contact Plating: 30 Microinches (0.76 Microns) Gold on the Mating Area, Tin on the Compliant Section and Contact Tails, Nickel Underplate. Other Plating Options Available upon Request.
- ◆ Current Rating: 3 Amperes Continuous
- ◆ Dielectric Withstanding Voltage: 1500 V AC rms at Sea Level Between Adjacent Contacts
- ◆ Insulation Resistance: 5000 Megohms Minimum
- ◆ Operating Temperature: -65 to +105 Degrees C
- ◆ Daughter Board Insertion Force: 16 oz (4.45 N) Maximum per Contact Pair when Tested with a .070 (1.78) Thick Gauge
- ◆ Daughter Board Withdrawal Force: 1 oz (0.28 N) Minimum per Contact Pair when Tested with a .054 (1.37) Thick Gauge
- ◆ Contact Insertion Into Hole: 20 lbs (89 N) Maximum
- ◆ Contact Retention In Hole: 10 lbs (44 N) Minimum
- ◆ Re-Insertability of Hole: 3 Times Minimum

746 SERIES ORDERING CODE

Example Part Number **746 - 070 - 525 - 6 01**

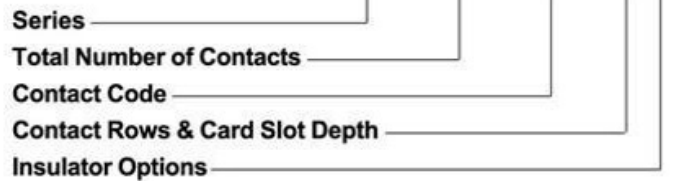

Series 746

| Total Number of Contacts ¹ | Contact Rows |
|---------------------------------------|--------------|
| 005, 006,...060 | Single Row |
| 010, 012,...120 | Dual Row |

| Contact Code ² | Description & Contact Point | Tail Length "G" |
|---------------------------|-----------------------------|-----------------|
| 520 | P.C. Tail Regular Point | .175 (4.45) |
| 525 | P.C. Tail High Point | .175 (4.45) |
| 527 | P.C. Tail High Point | .375 (9.53) |
| 540 | Wire Wrap Regular Point | .560 (14.22) |
| 541 | Wire Wrap Regular Point | .750 (19.05) |
| 545 | Wire Wrap High Point | .560 (14.22) |
| 553 | Wire Wrap Medium Point | .702 (17.83) |

| Contact Rows & Card Slot Depth | Description |
|--------------------------------|-------------------------------------|
| 1 | Single Row, .515 (13.08) Slot Depth |
| 2 | Dual Row, .515 (13.08) Slot Depth |
| 5 | Single Row, .340 (8.64) Slot Depth |
| 6 | Dual Row, .340 (8.64) Slot Depth |

| Insulator Options | Description |
|-------------------|-------------------------------|
| 01 | .645 (16.38) Full Height Ends |
| 06 | .550 (13.97) Notched Ends |

Ordering Code Notes

- 1) All connector sizes up to 60 contacts single row / 120 contacts dual row are available upon request.
- 2) Make-before-break switching contacts, assembled in specific contact positions, are available upon request.

IN-CONTACT
POLARIZING KEY

P/N 745-240-328



BETWEEN CONTACT
POLARIZING KEY

P/N 306-240-318



PRESS FIT CARD EDGE CONNECTOR SERIES 746

Compliant Pin, Contact Spacing .125" (3.18mm)

SECTIONS "Y"-"Y" CONTACT ROWS & INSULATOR OPTIONS

Single Row Versions May Require Backup Springs Depending on the Application. Consult with EDAC for Details.

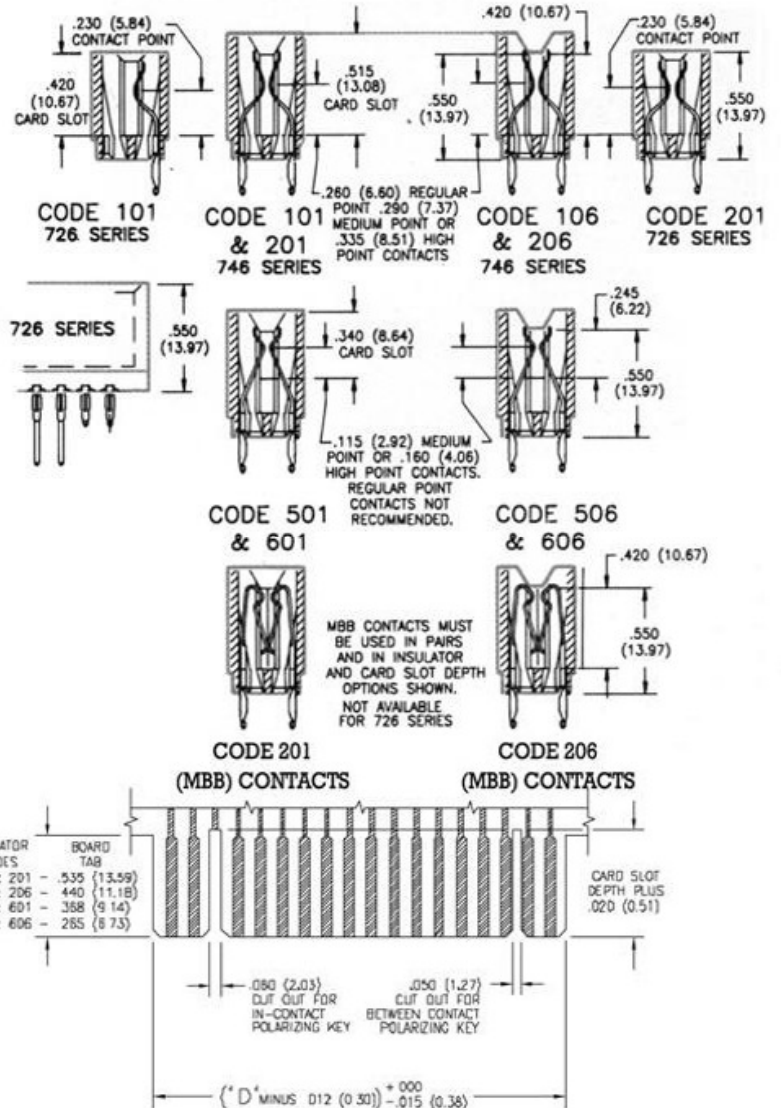
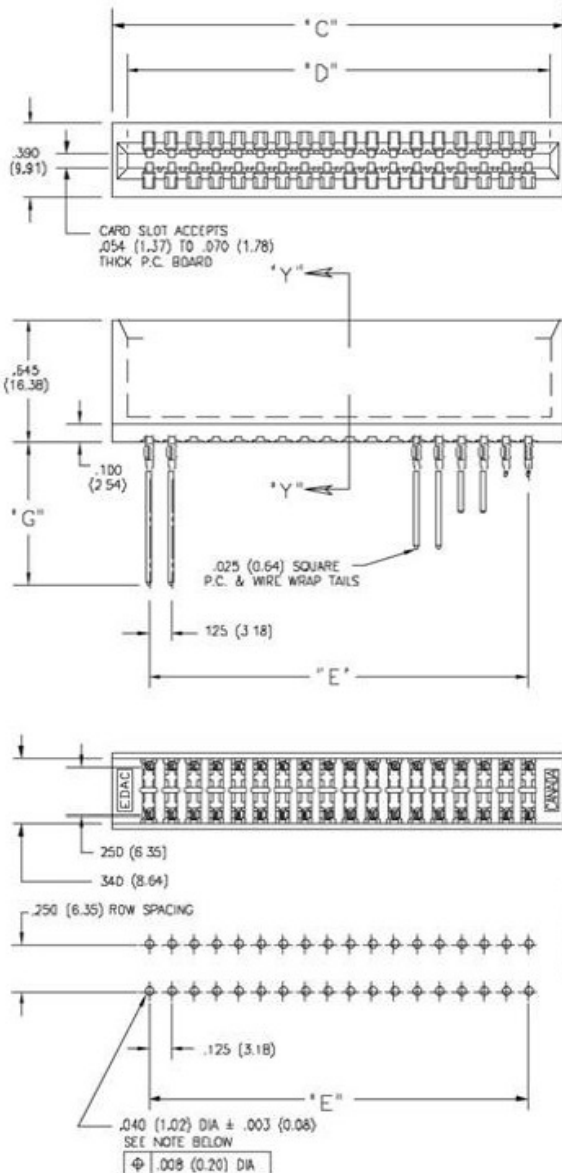

| NUMBER OF CONTACTS | | "C" | | "D" | | "E" | |
|--------------------|------|-------|----------|-------|----------|-------|----------|
| Single | Dual | Inch | (mm) | Inch | (mm) | Inch | (mm) |
| 5 | 10 | .910 | (23.11) | .750 | (19.05) | .500 | (12.70) |
| 6 | 12 | 1.035 | (26.29) | .875 | (22.23) | .625 | (15.88) |
| 15 | 30 | 2.160 | (54.86) | 2.000 | (50.80) | 1.750 | (44.45) |
| 18 | 36 | 2.535 | (64.39) | 2.375 | (60.33) | 2.125 | (53.98) |
| 22 | 44 | 3.035 | (77.09) | 2.875 | (73.03) | 2.625 | (66.68) |
| 25 | 50 | 3.410 | (86.61) | 3.250 | (82.55) | 3.000 | (76.20) |
| 28 | 56 | 3.785 | (96.14) | 3.625 | (92.08) | 3.375 | (85.73) |
| 30 | 60 | 4.035 | (102.49) | 3.875 | (98.43) | 3.625 | (92.08) |
| 35 | 70 | 4.660 | (118.36) | 4.500 | (114.30) | 4.250 | (107.95) |
| 36 | 72 | 4.785 | (121.54) | 4.625 | (117.48) | 4.375 | (111.13) |
| 40 | 80 | 5.285 | (134.24) | 5.125 | (130.18) | 4.875 | (123.83) |
| 43 | 86 | 5.660 | (143.76) | 5.500 | (139.70) | 5.250 | (133.35) |
| 50 | 100 | 6.535 | (165.99) | 6.375 | (161.93) | 6.125 | (155.58) |
| 60 | 120 | 7.785 | (197.74) | 7.625 | (193.68) | 7.375 | (187.33) |

Dimensions of Other Connector Sizes are Listed

737 SERIES PRESS FIT CARD EDGE CONNECTOR

.156" (3.96mm) Contact Spacing, Compliant Pin

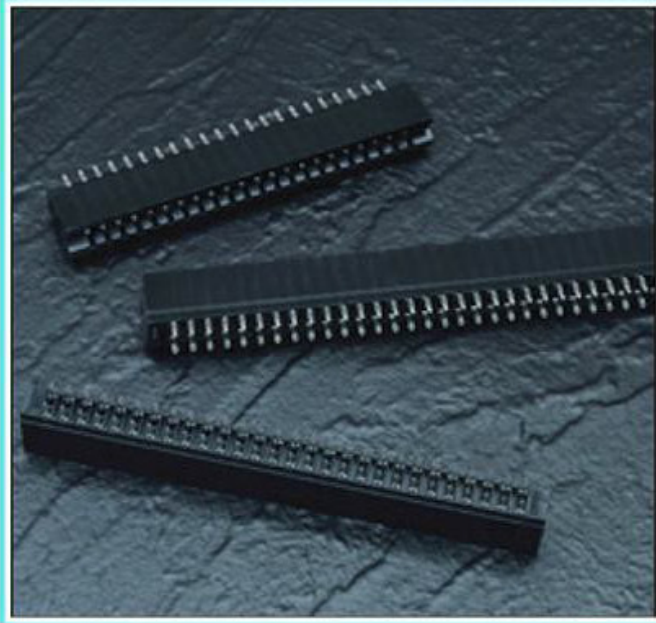

FEATURES

- UL Recognized
- .156 (3.96) Contact Spacing x .200 (5.08) Row Spacing
- Accepts .062 (1.57) Nominal Thickness P.C. Board
- High Profile Insulator Body, .645 (16.38) with End Notches
- **Press Fit Compliant Section for Gas-Tight Reliable Connection in Plated Through Holes Eliminates Soldering Operations**
- Contact Termination Options include P.C. Tail and .025 (0.64) Square Wire Wrap
- Single or Dual Row Configurations
- Accepts Between Contact and In-Contact Polarizing Keys
- Tools Available for Insulator and Contact Removal. Simple "Flat Rock" Tooling is Used for Connector Installation

SPECIFICATIONS

- ◆ Insulator Material: Thermoplastic Polyester, UL 94V-O, Colour: Black
- ◆ **Contact Material: Copper Alloy**
- ◆ Contact Plating: 30 Microinches (0.76 Microns) Gold on the Mating Area, Tin on the Compliant Section and Contact Tails, Nickel Underplate. Other Plating Options Available upon Request.
- ◆ Current Rating: 3 Amperes Continuous
- ◆ Contact Resistance: 10 Milliohms Maximum
- ◆ Dielectric Withstanding Voltage: 1800 V AC rms at Sea Level Between Adjacent Contacts
- ◆ Insulation Resistance: 5000 Megohms Minimum
- ◆ Operating Temperature: -65 to +105 Degrees C
- ◆ Daughter Board Insertion Force: 16 oz (4.45 N) Maximum per Contact Pair when Tested with a .070 (1.78) Thick Gauge
- ◆ Daughter Board Withdrawal Force: 1 oz (0.28 N) Minimum per Contact Pair when Tested with a .054 (1.37) Thick Gauge
- ◆ Contact Insertion into Hole: 20 lbs (89 N) Maximum
- ◆ Contact Retention in Hole: 10 lbs (44 N) Minimum
- ◆ Re-Insertability of Hole: 3 Times Minimum

737 SERIES ORDERING CODE

Example Part Number **737 - 044 - 520 - 206**

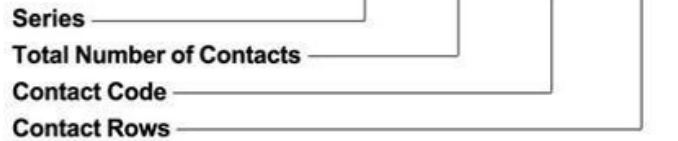

Series 737

| Total Number of Contacts ¹ | Contact Rows |
|---------------------------------------|--------------|
| 005, 006,...043 | Single Row |
| 010, 012,...086 | Dual Row |

| Contact Code ² | Description & Contact Point | Tail Length "G" |
|---------------------------|-----------------------------|-----------------|
| 520 | P.C. Tail Regular Point | .175 (4.45) |
| 522 | P.C. Tail Regular Point | .375 (9.53) |
| 525 | P.C. Tail High Point | .175 (4.45) |
| 540 | Wire Wrap Regular Point | .560 (14.22) |
| 541 | Wire Wrap Regular Point | .750 (19.05) |
| 545 | Wire Wrap High Point | .560 (14.22) |

| Contact Rows | Description |
|--------------|-------------|
| 106 | Single Row |
| 206 | Dual Row |

Ordering Code Notes

- 1) All connector sizes up to 43 contacts single row / 86 contacts dual row are available upon request.
- 2) Make-before-break switching contacts, assembled in specific contact positions, are available upon request.

IN-CONTACT
POLARIZING KEY

P/N 745-240-32B



BETWEEN CONTACT
POLARIZING KEY

P/N 306-240-31B



PRESS FIT CARD EDGE CONNECTOR SERIES 737

Compliant Pin, Contact Spacing .156" (3.96mm)

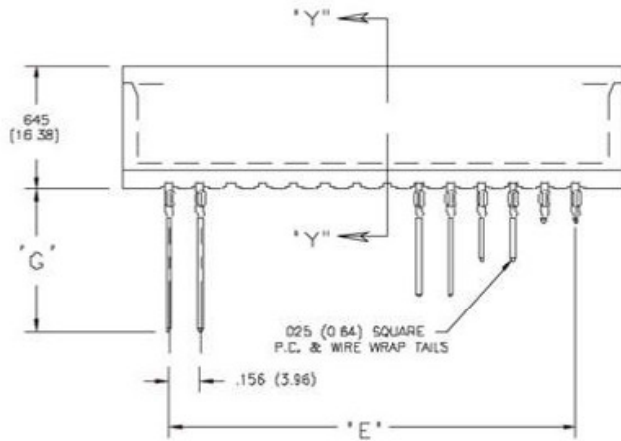
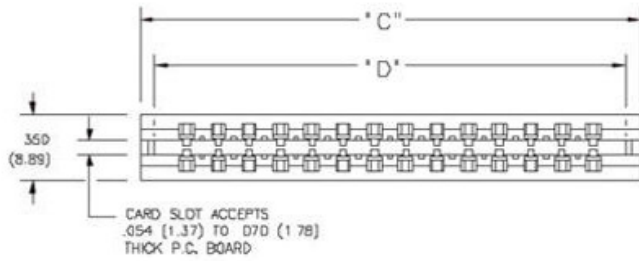

SECTIONS "Y" - "Y" CONTACT ROW OPTIONS

Single Row Version, Code 106, May Require Backup Springs
Depending on the Application Consult with EDAC for Details.

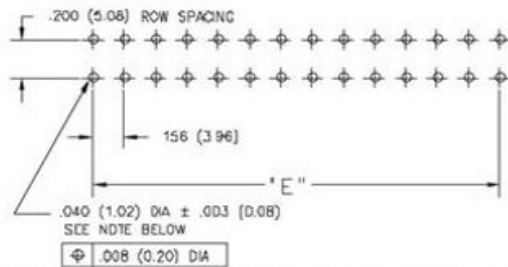
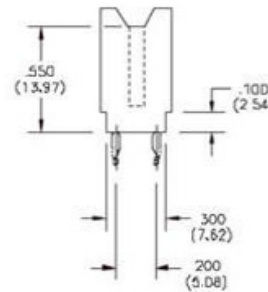
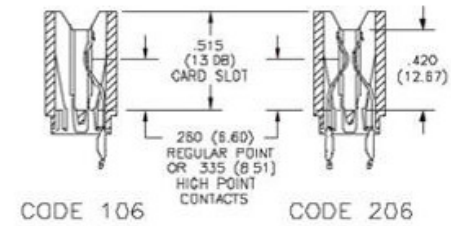

RECOMMENDED MOTHER BOARD HOLE PATTERN

TO OBTAIN OPTIMUM COMPLIANT SECTION PERFORMANCE,
DRILL HOLES $D45.3 \pm .001$ (.15 ± 0.03) DIAMETER
COPPER PLATE, .001 (25.4 MICRONS) MINIMUM THICKNESS,
FOLLOWED BY TIN PLATE TO PROVIDE FINISHED
HOLES $D40 \pm .003$ (.12 ± 0.08) DIAMETER

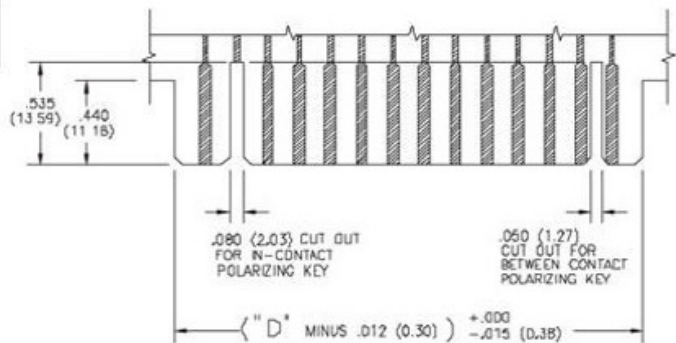

RECOMMENDED DAUGHTER BOARD

| NUMBER OF CONTACTS | | "C" | | "D" | | "E" | |
|--------------------|------|-------|----------|-------|----------|-------|----------|
| Single | Dual | Inch | (mm) | Inch | (mm) | Inch | (mm) |
| 5 | 10 | 1.246 | (31.65) | 1.100 | (27.94) | .780 | (19.81) |
| 6 | 12 | 1.402 | (35.61) | 1.256 | (31.90) | .936 | (23.77) |
| 10 | 20 | 2.026 | (51.46) | 1.880 | (47.75) | 1.560 | (39.62) |
| 15 | 30 | 2.806 | (71.27) | 2.660 | (67.56) | 2.340 | (59.44) |
| 18 | 36 | 3.274 | (83.16) | 3.128 | (79.45) | 2.808 | (71.32) |
| 20 | 40 | 3.586 | (91.08) | 3.440 | (87.38) | 3.120 | (79.25) |
| 22 | 44 | 3.898 | (99.01) | 3.752 | (95.30) | 3.432 | (87.17) |
| 25 | 50 | 4.366 | (110.90) | 4.220 | (107.19) | 3.900 | (99.06) |
| 28 | 56 | 4.834 | (122.78) | 4.688 | (119.08) | 4.368 | (110.95) |
| 30 | 60 | 5.146 | (130.71) | 5.000 | (127.00) | 4.680 | (118.87) |
| 31 | 62 | 5.302 | (134.67) | 5.156 | (130.96) | 4.836 | (122.83) |
| 33 | 66 | 5.614 | (142.60) | 5.468 | (138.89) | 5.148 | (130.76) |
| 36 | 72 | 6.082 | (154.48) | 5.936 | (150.77) | 5.616 | (142.65) |
| 43 | 86 | 7.174 | (182.22) | 7.028 | (178.51) | 6.708 | (170.38) |

Dimensions of Other Connector Sizes are Listed

745 SERIES (98 PIN-AT) PRESS FIT CARD EDGE CONNECTOR

.100" (2.54mm) Contact Spacing, Compliant Pin

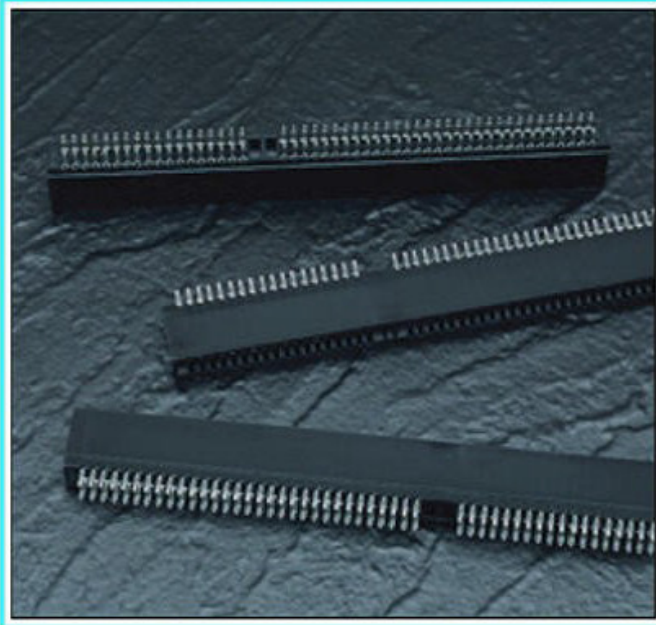

745 SERIES (98 PIN-AT) ORDERING CODE

Example Part Number **745 - 098 - 520 - 900**

Series _____
 Total Number of Contacts _____
 Contact Code _____
 Variation Code _____

Series 745

Total Number of Contacts 098

Contact Code

See 745 Series for Available Contact Options and "G" Dimension

Variation Code

Description

900 Card Slot Barrier with .645 (16.38) Full Height Ends
 904 Card Slot Barrier with .550 (13.97) Notched Ends

FEATURES

- CSA Approved and UL Recognized
- Press Fit Compliant Pin Connector for IBM-AT Industry Standard Architecture
- Card Slot Barrier Divides 98 Pin Connector into Groups of 62 and 36 Contacts
- For Additional Features and Specifications, Refer to 745 Series

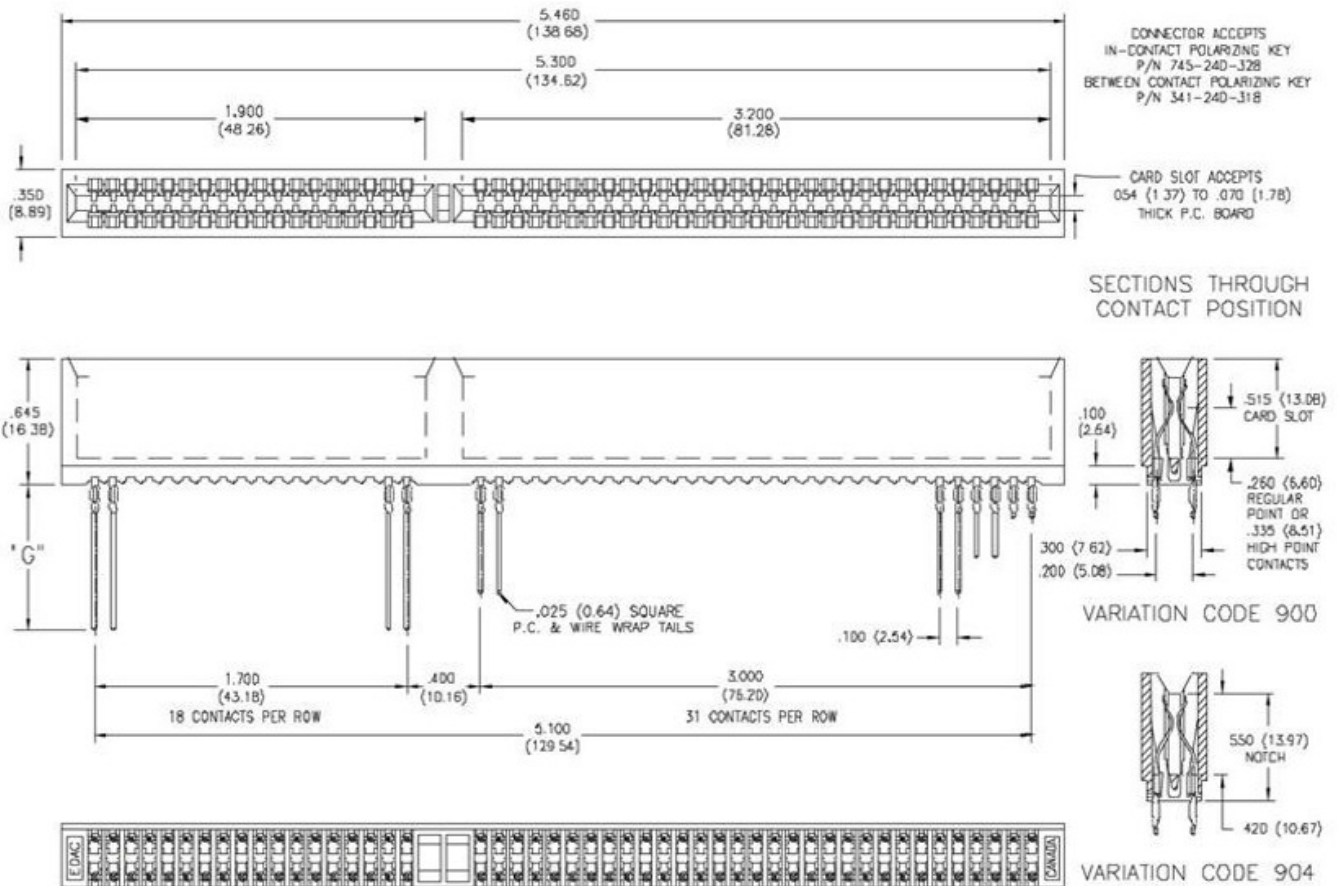

EISA CARD EDGE CONNECTOR SERIES 301

Contact Spacing .050" (1.27mm)

301 SERIES ORDERING CODE

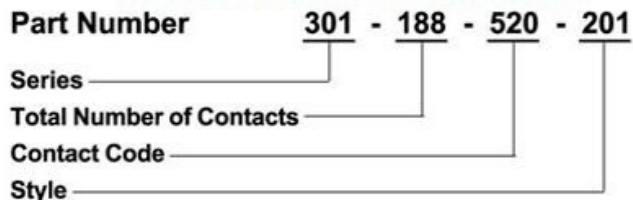

FEATURES

- EISA or ISA (IBM XT/AT) Daughter Boards Accommodated with Bi-Level Contact Points and Card Slot Depths
- .050 (1.27) Contact Spacing with Staggered Tail Bend Results in 4 Rows at .100 (2.54) Spacing
- Accepts .062 (1.57) Nominal Thickness P.C. Board, Accurately Positioned by a Card Slot Barrier
- High Profile Insulator Body, .610 (15.49)
- Mounting Posts Provide Positive Location and Retention
- P.C. Tail Contact Termination

SPECIFICATIONS

- ◆ Insulator Material: Polyphenylene Sulphide, UL 94V-0, Colour: Brown
- ◆ **Contact Material: Copper Alloy**
- ◆ Contact Plating: Gold on the Mating Area, Tin on the Contact Tails, Nickel Underplate
- ◆ Current Rating: 1 Ampere Continuous
- ◆ Contact Resistance: 30 Milliohms Maximum
- ◆ Dielectric Withstanding Voltage: 500 V AC rms at Sea Level
- ◆ Insulation Resistance: 1000 Megohms Minimum
- ◆ Operating Temperature: -55 to +85 Degrees C
- ◆ Insertion Force: 6 oz (1.67 N) Maximum per Contact Pair when Tested with a .062 (1.57) Thick Gauge
- ◆ Withdrawal Force: .75 oz (0.21 N) Minimum per Contact Pair when Tested with a .062 (1.57) Thick Gauge

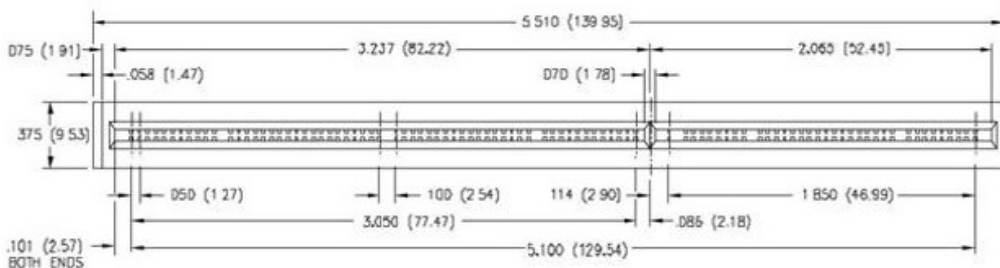
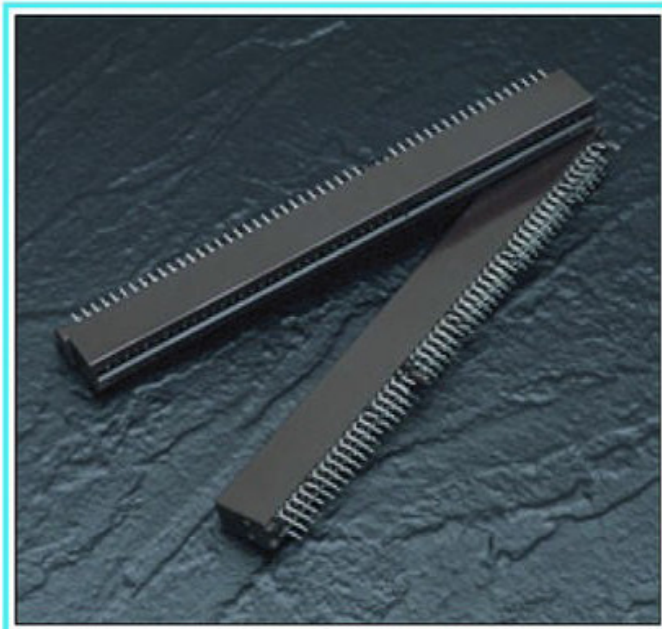

SECTION THROUGH CONTACT POSITION
SHOWING BOTH UPPER AND LOWER TIER CONTACTS (OPPOSING CONTACTS ARE ACTUALLY ON THE SAME TIER)

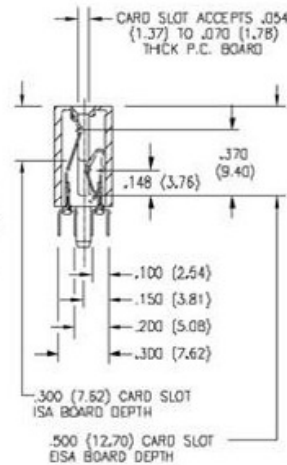
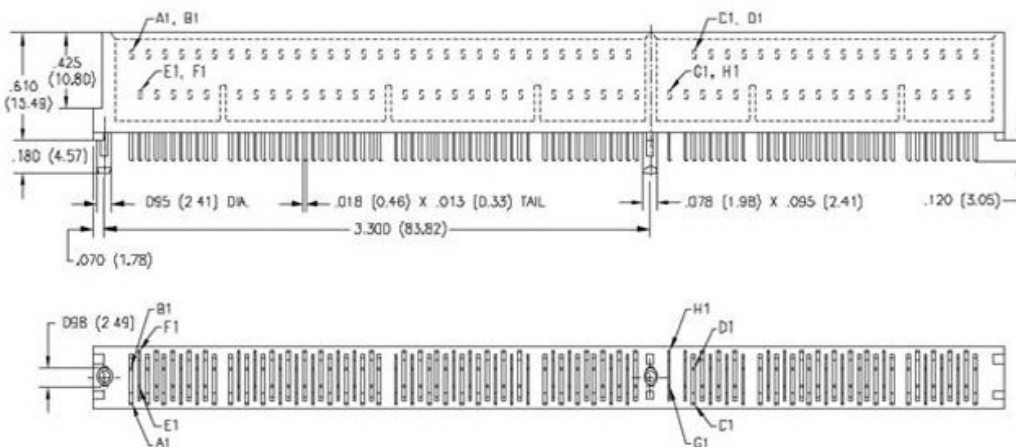

302 SERIES MCA CARD EDGE CONNECTOR

.050"(1.27mm) Contact Spacing

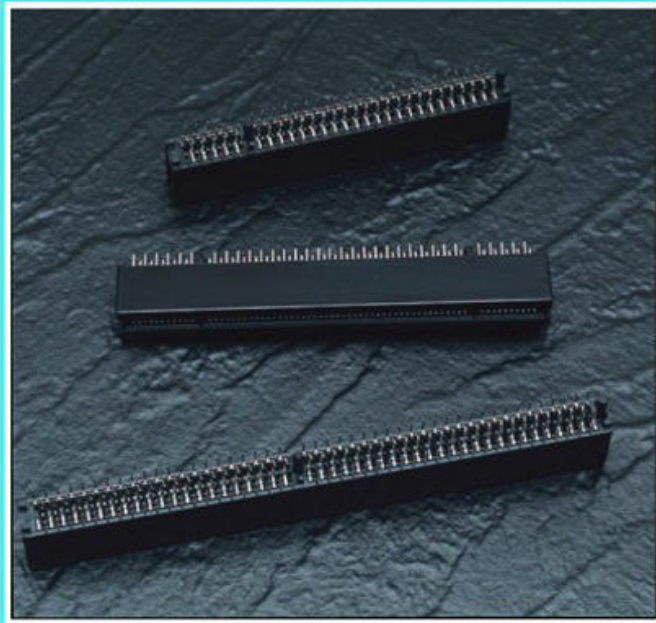

302 SERIES ORDERING CODE

Example Part Number **302 - 182 - 520 - 201**

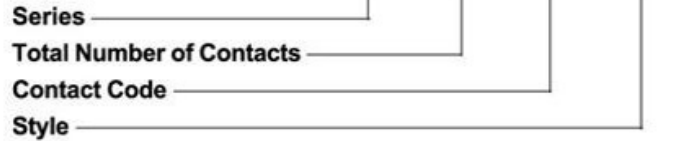

Series 302

| Total Number of Contacts | Description |
|--------------------------|---|
| 112 | Divided into Groups of 90 & 22 Contacts |
| 132 | Divided into Groups of 20, 90 & 22 Contacts |
| 182 | Divided into Groups of 98 & 84 Contacts |

Contact Code 520

Style 201

FEATURES

- Accommodates MCA (Microchannel Architecture) Daughter Boards for IBM PS/2 Systems
- .050 (1.27) Contact Spacing with Staggered Tail Bend Results in 4 Rows at .100 (2.54) Spacing
- Accepts .062 (1.57) Nominal Thickness P.C. Board, Accurately Positioned by Card Slot Barrier
- High Profile Insulator Body, .610 (15.49)
- Mounting Posts Provide Positive Location and Retention
- P.C. Tail Contact Termination
- Many other sizes available. Please contact Edac for additional items

SPECIFICATIONS

- Insulator Material: Polyphenylene Sulphide, UL 94V-0, Colour: Black
- Contact Material: Copper Alloy
- Contact Plating: Gold on the Mating Area, Tin on the Contact Tails, Nickel Underplate
- Current Rating: 1 Ampere Continuous
- Contact Resistance: 30 Milliohms Maximum
- Dielectric Withstanding Voltage: 500 V AC rms at Sea Level
- Insulation Resistance: 1000 Megohms Minimum
- Operating Temperature: -65 to +125 Degrees C
- Insertion Force: 8 oz (2.22 N) Maximum per Contact Pair when Tested with a .062 (1.57) Thick Gauge
- Withdrawal Force: 1 oz (0.28 N) Minimum per Contact Pair when Tested with a .062 (1.57) Thick Gauge

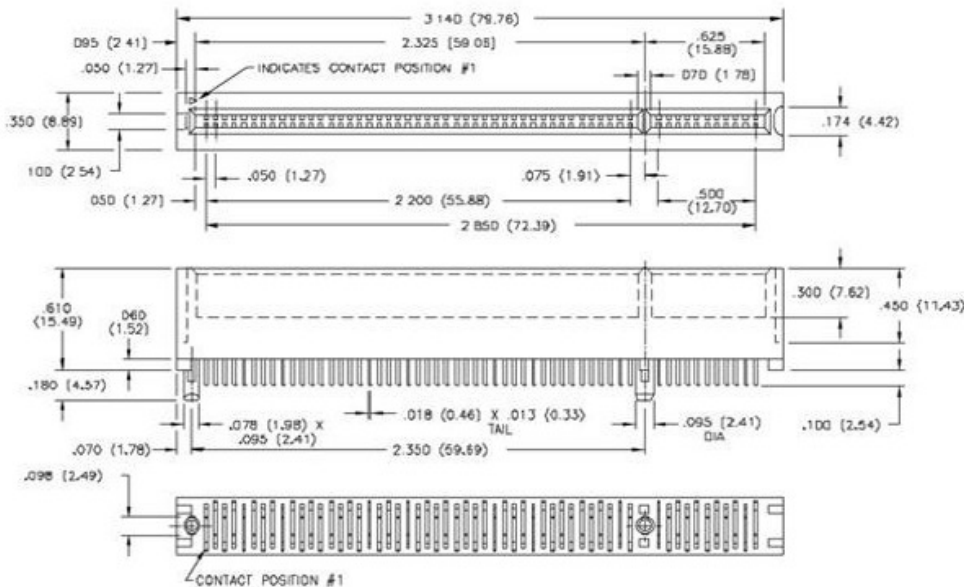

P/N 302-112-520-201

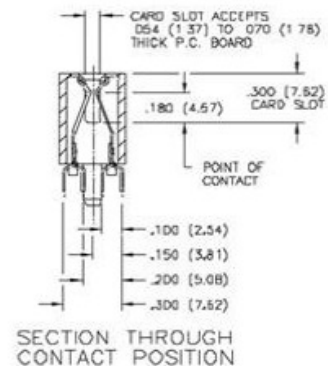

MCA CARD EDGE CONNECTOR SERIES 302

Contact Spacing .050" (1.27mm)

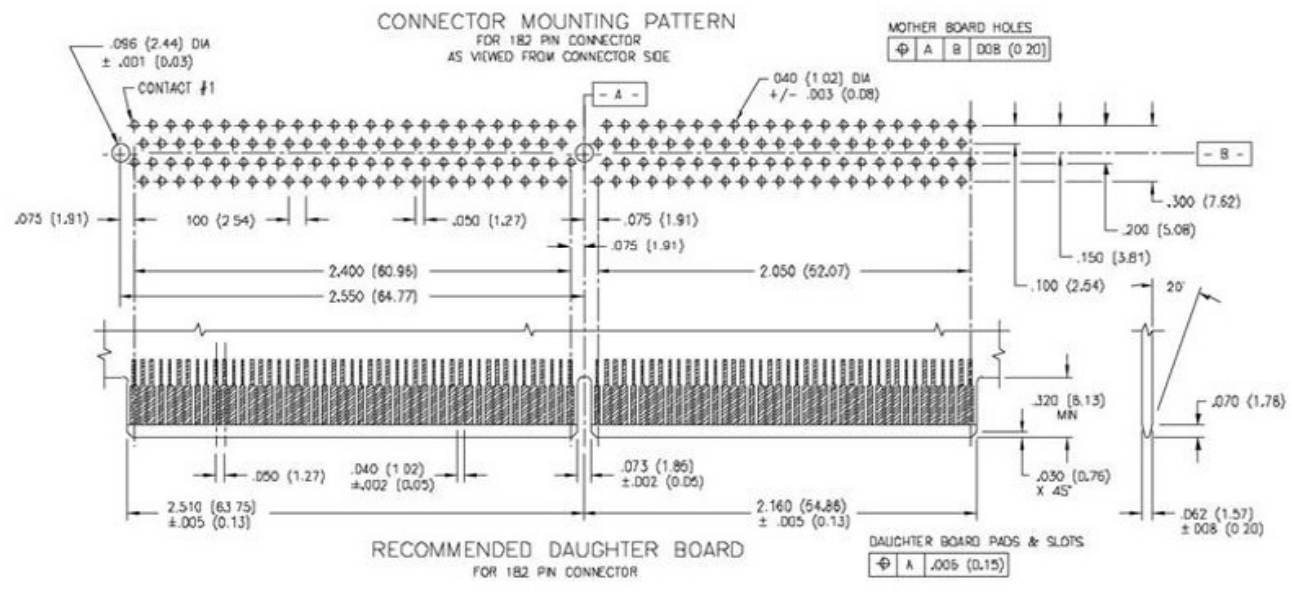
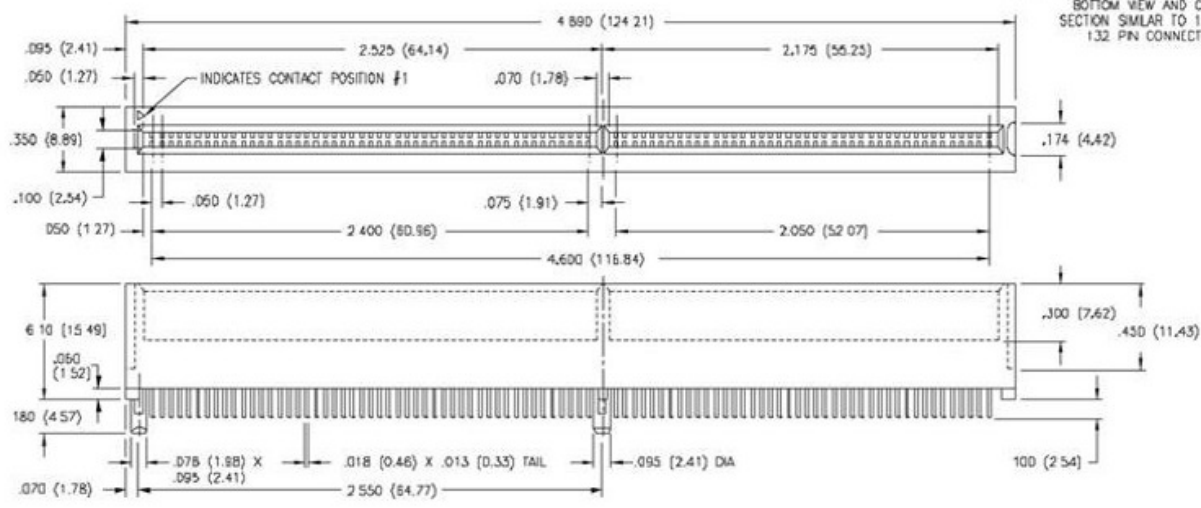
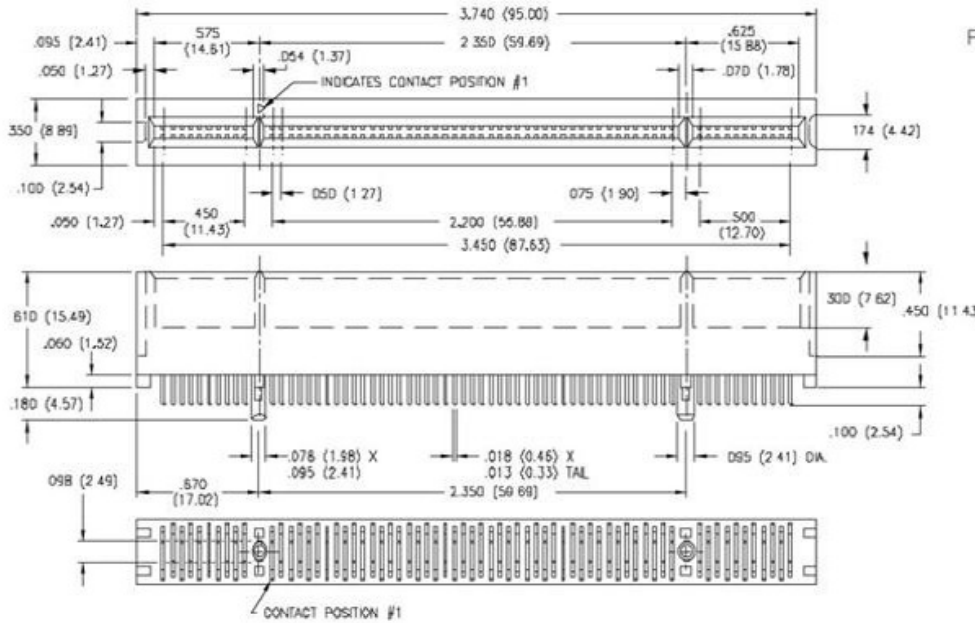

345/395 SERIES CARD EDGE CONNECTOR

.100" (2.54mm) Contact Spacing

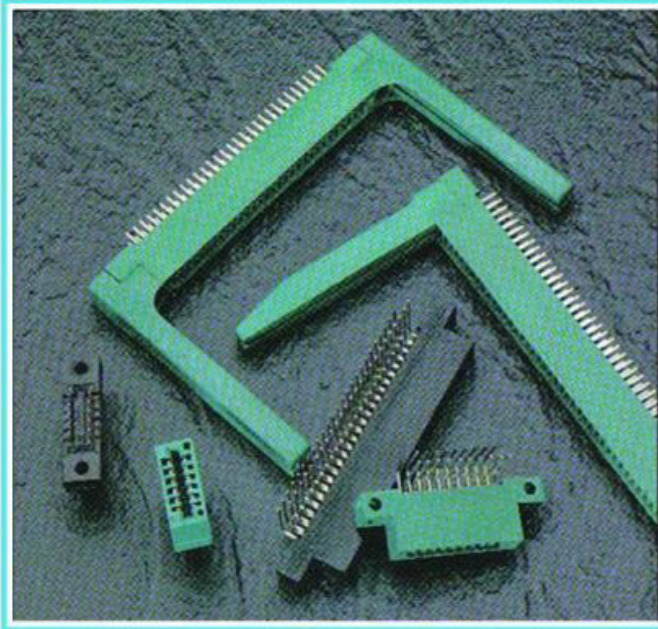

FEATURES

- CSA Approved and UL Recognized
- .100 (2.54) Contact Spacing x .200 (5.08) Row Spacing
- Accepts .062 (1.57) Nominal Thickness P.C. Board
- High Profile Insulator Body, .600 (15.24)
- Contact Termination Options include P.C. Tail, Wire Hole, Wire Wrap, 90 Degree & Extender Board Bends
- Single or Dual Row Configurations
- Large Variety of Mounting Options, Flush or Offset Lugs
- Pre-assembled Card Guides Available
- Accepts Between Contact and In-Contact Polarizing Keys
- Automatic Wire Wrap Positioning Holes

SPECIFICATIONS

- ◆ Insulator Material: Thermoplastic Polyester, UL 94V-0
- ◆ **Contact Material: Copper Alloy**
- ◆ Contact Plating: Gold on the Mating Area, Tin on the Contact Tails, Nickel Underplate
- ◆ Current Rating: 3 Amperes Continuous
- ◆ Contact Resistance: 10 Milliohms Maximum
- ◆ Dielectric Withstanding Voltage: 1200 V AC rms at Sea Level Between Adjacent Contacts
- ◆ Insulation Resistance: 5000 Megohms Minimum
- ◆ Operating Temperature: -65 to +105 Degrees C
- ◆ Insertion Force: 16 oz (4.45 N) Maximum per Contact Pair when Tested with a .070 (1.78) Thick Gauge
- ◆ Withdrawal Force: 1 oz (0.28 N) Minimum per Contact Pair when Tested with a .054 (1.37) Thick Gauge

345/395 SERIES ORDERING CODE

Example Part Number **345 - 050 - 520 - 2 02**

Series _____
 Total Number of Contacts _____
 Contact Code _____
 Contact Rows and Insulator Style _____
 Mounting Options _____

| Series | Insulator Colour |
|--------|------------------|
| 345 | Green |
| 395 | Black |

| Total Number of Contacts ¹ | Contact Rows |
|---------------------------------------|--------------|
| 005, 006,...072 | Single Row |
| 010, 012,...144 | Dual Row |

| Contact Code ^{2,3} | Description & Tail Size | Tail Length"G" |
|-----------------------------|---|----------------|
| 500 | Wire Hole .050 x .025 (1.27 x 0.64) | .260 (6.60) |
| 520 | P.C. Tail .030 x .018 (0.76 x 0.46) | .175 (4.45) |
| 521 | P.C. Tail .025 Square (0.64 Square) | .150 (3.81) |
| 523 | P.C. Tail .025 Square (0.64 Square) | .390 (9.91) |
| 524 | P.C. Tail .018 Square (0.46 Square) | .175 (4.45) |
| 540 | Wire Wrap .025 Square (0.64 Square) | .560 (14.22) |
| 541 | Wire Wrap .025 Square (0.64 Square) | .750 (19.05) |
| 542 | Wire Wrap .025 Square (0.64 Square) | .645 (16.38) |
| 544 | Wire Wrap .050 x .025 (1.27 x 0.64) | .750 (19.05) |
| 555 | Extender Board Bend (Code 500 Contacts) | |
| 556 | Extender Board Bend (Code 520 Contacts) | |
| 558 | 90 Degree Bend (Code 541 Contacts) | |
| 559 | 90 Degree Bend (Code 541 Contacts) | |
| 560 | Extender Board Bend (Code 523 Contacts) | |

| Contact Rows and Insulator Style | Description |
|----------------------------------|-------------------------------------|
| 1 | Single Row, Flush Mounting Lugs |
| 2 | Dual Row, Flush Mounting Lugs |
| 4 | Single Row, .110 (2.79) Offset Lugs |
| 5 | Dual Row, .110 (2.79) Offset Lugs |
| 6 | Single Row, .170 (4.32) Offset Lugs |
| 8 | Dual Row, .170 (4.32) Offset Lugs |

| Mounting Options ^{4,5} | Description |
|---------------------------------|--|
| 01 | No Mounting Lugs |
| 02 | .128 (3.25) Dia. Mounting Holes |
| 03 | .116 (2.95) I.D. Floating Eyelets |
| 04 | .156 (3.96) Dia. Mounting Holes |
| 07 | M3-0.5 Metric Threaded Inserts |
| 08 | #4-40 Unified Threaded Inserts |
| 12 | .128 (3.25) Dia. Side Mounting Holes |
| 58 | .468 (11.89) Offset Card Guides |
| 78 | In-Line Card Guides 2.750 (69.85) Long |
| 88 | In-Line Card Guides 1.250 (31.75) Long |

Ordering Code Notes

- 1) All connector sizes up to 72 contacts single row / 144 contacts dual row are available upon request.
- 2) The 500 contact code is only available in the 345 series. Green polyphenylene sulphide insulator material will be supplied.
- 3) For details of the extender board and 90 degree bends, refer to page 61.
- 4) For lugless connectors, code 01 mounting, specify contact row codes 1 or 2.
- 5) For details of the mounting options, refer to page 63.

CARD EDGE CONNECTOR SERIES 345/395

Contact Spacing .100" (2.54mm)

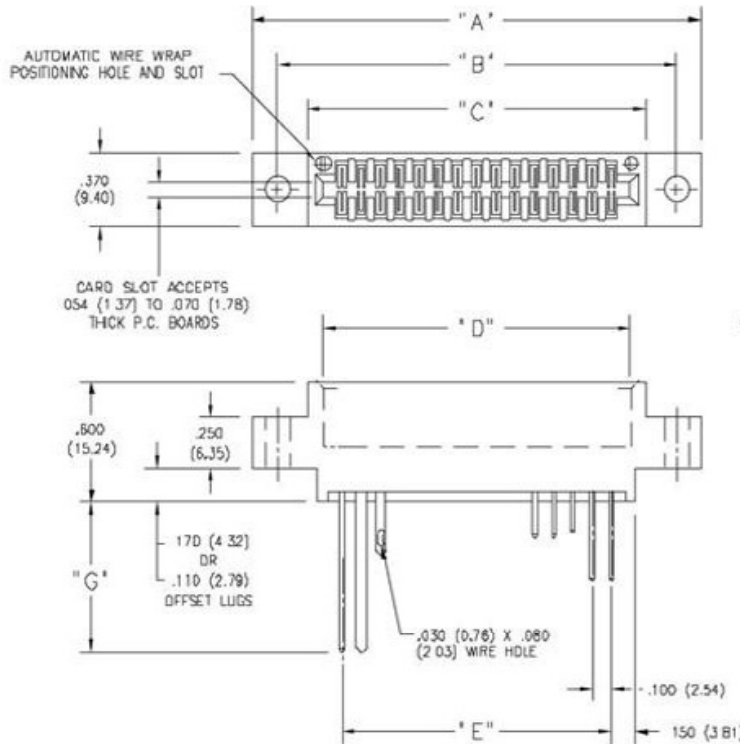

SECTIONS THROUGH CONTACT POSITION

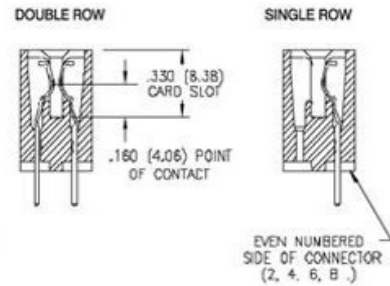

IN-CONTACT POLARIZING KEY

P/N 345-240-328



BETWEEN CONTACT POLARIZING KEY

P/N 345-240-318

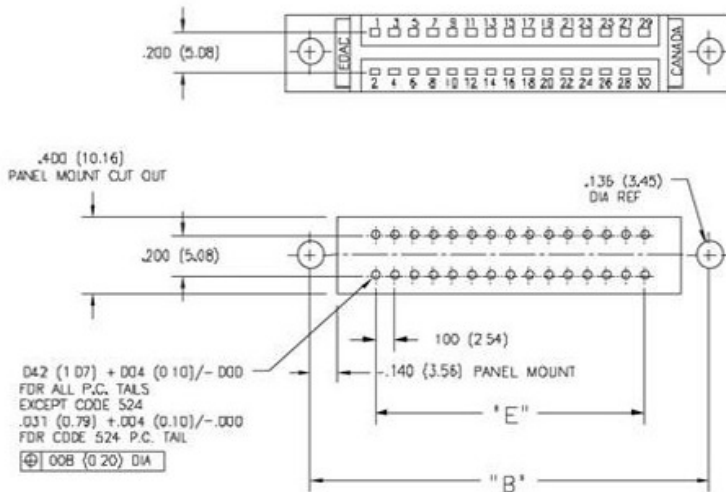

CONNECTOR MOUNTING PATTERN

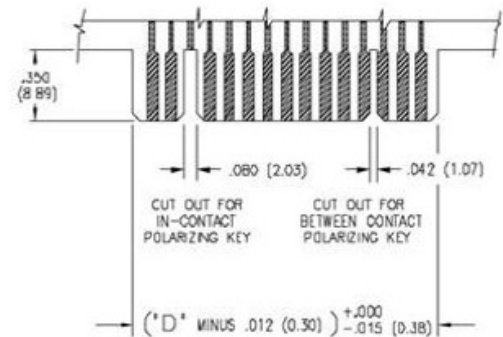

RECOMMENDED DAUGHTER BOARD

| NUMBER OF CONTACTS | | "A" | | "B" | | "C" | | "D" | | "E" | |
|--------------------|------|-------|----------|-------|----------|-------|----------|-------|----------|-------|----------|
| Single | Dual | Inch | (mm) | Inch | (mm) | Inch | (mm) | Inch | (mm) | Inch | (mm) |
| 5 | 10 | 1.335 | (33.91) | 1.075 | (27.31) | .760 | (19.30) | .600 | (15.24) | .400 | (10.16) |
| 10 | 20 | 1.835 | (46.61) | 1.575 | (40.01) | 1.260 | (32.00) | 1.100 | (27.94) | .900 | (22.86) |
| 13 | 26 | 2.135 | (54.23) | 1.875 | (47.63) | 1.560 | (39.62) | 1.400 | (35.56) | 1.200 | (30.48) |
| 15 | 30 | 2.335 | (59.31) | 2.075 | (52.71) | 1.760 | (44.70) | 1.600 | (40.64) | 1.400 | (35.56) |
| 18 | 36 | 2.635 | (66.93) | 2.375 | (60.33) | 2.060 | (52.32) | 1.900 | (48.26) | 1.700 | (43.18) |
| 22 | 44 | 3.035 | (77.09) | 2.775 | (70.49) | 2.460 | (62.48) | 2.300 | (58.42) | 2.100 | (53.34) |
| 25 | 50 | 3.335 | (84.71) | 3.075 | (78.11) | 2.760 | (70.10) | 2.600 | (66.04) | 2.400 | (60.96) |
| 30 | 60 | 3.835 | (97.41) | 3.575 | (90.81) | 3.260 | (82.80) | 3.100 | (78.74) | 2.900 | (73.66) |
| 31 | 62 | 3.935 | (99.95) | 3.675 | (93.35) | 3.360 | (85.34) | 3.200 | (81.28) | 3.000 | (76.20) |
| 36 | 72 | 4.435 | (112.65) | 4.175 | (106.05) | 3.860 | (98.04) | 3.700 | (93.98) | 3.500 | (88.90) |
| 43 | 86 | 5.135 | (130.43) | 4.875 | (123.83) | 4.560 | (115.82) | 4.400 | (111.76) | 4.200 | (106.68) |
| 50 | 100 | 5.835 | (148.21) | 5.575 | (141.61) | 5.260 | (133.60) | 5.100 | (129.54) | 4.900 | (124.46) |
| 60 | 120 | 6.835 | (173.61) | 6.575 | (167.01) | 6.260 | (159.00) | 6.100 | (154.94) | 5.900 | (149.86) |
| 72 | 144 | 8.035 | (204.09) | 7.775 | (197.49) | 7.460 | (189.48) | 7.300 | (185.42) | 7.100 | (180.34) |

Dimensions of Other Connector Sizes are Listed

341/391 SERIES CARD EDGE CONNECTOR

.100" (2.54mm) Contact Spacing



FEATURES

- UL Recognized
- .100 (2.54) Contact Spacing x .140 (3.56) Row Spacing
- Accepts .062 (1.57) Nominal Thickness P.C. Board
- Low Profile Insulator Body, .437 (11.10)
- Contact Termination Options include P.C. Tail, Wire Hole & Extender Board Bends
- Single or Dual Row Configurations
- Variety of Mounting Options
- Accepts Between Contact and In-Contact Polarizing Keys

SPECIFICATIONS

- ◆ Insulator Material: Thermoplastic Polyester, UL 94V-0
- ◆ **Contact Material: Copper Alloy**
- ◆ Contact Plating: Gold on the Mating Area, Tin on the Contact Tails, Nickel Underplate
- ◆ Current Rating: 3 Amperes Continuous
- ◆ Contact Resistance: 10 Milliohms Maximum
- ◆ Dielectric Withstanding Voltage: 1200 V AC rms at Sea Level Between Adjacent Contacts
- ◆ Insulation Resistance: 5000 Megohms Minimum
- ◆ Operating Temperature: -65 to +105 Degrees C
- ◆ Insertion Force: 16 oz (4.45 N) Maximum per Contact Pair when Tested with a .070 (1.78) Thick Gauge
- ◆ Withdrawal Force: 1 oz (0.28 N) Minimum per Contact Pair when Tested with a .054 (1.37) Thick Gauge

341/391 SERIES ORDERING CODE

Example Part Number **341 - 062 - 520 - 2 02**

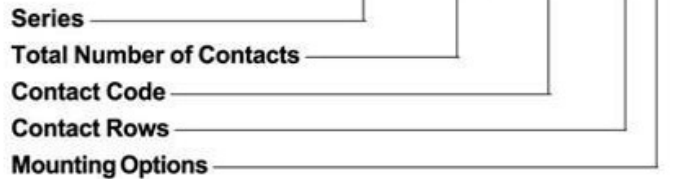

| Series | Insulator Colour |
|--------|------------------|
| 341 | Green |
| 391 | Black |

| Total Number of Contacts ¹ | Contact Rows |
|---------------------------------------|--------------|
| 005, 006,...060 | Single Row |
| 010, 012,...120 | Dual Row |

| Contact Code ^{2,3} | Description & Tail Size | Tail Length "G" |
|-----------------------------|---|-----------------|
| 500 | Wire Hole .050 x .013 (1.27 x 0.33) | .220 (5.59) |
| 520 | P.C. Tail .025 x .013 (0.64 x 0.33) | .125 (3.18) |
| 521 | P.C. Tail .025 x .013 (0.64 x 0.33) | .260 (6.60) |
| 522 | P.C. Tail .025 x .013 (0.64 x 0.33) | .375 (9.53) |
| 524 | P.C. Tail .025 x .013 (0.64 x 0.33) | .100 (2.54) |
| 555 | Extender Board Bend (Code 500 Contacts) | |
| 556 | Extender Board Bend (Code 521 Contacts) | |
| 560 | Extender Board Bend (Code 522 Contacts) | |

| Contact Rows | Description |
|--------------|-------------|
| 1 | Single Row |
| 2 | Dual Row |

| Mounting Options ⁴ | Description |
|-------------------------------|-----------------------------------|
| 01 | No Mounting Lugs |
| 02 | .128 (3.25) Dia. Mounting Holes |
| 03 | .116 (2.95) I.D. Floating Eyelets |
| 04 | .156 (3.96) Dia. Mounting Holes |
| 07 | M3-0.5 Metric Threaded Inserts |
| 08 | #4-40 Unified Threaded Inserts |

Ordering Code Notes

- 1) All connector sizes up to 60 contacts single row / 120 contacts dual row are available upon request.
- 2) The 500 contact code is only available in the 341 series. Green polyphenylene sulphide insulator material will be supplied.
- 3) For details of the extender board bends, refer to page 61.
- 4) For details of the mounting options, refer to page 63.

CARD EDGE CONNECTOR SERIES 341/391

Contact Spacing .100" (2.54mm)

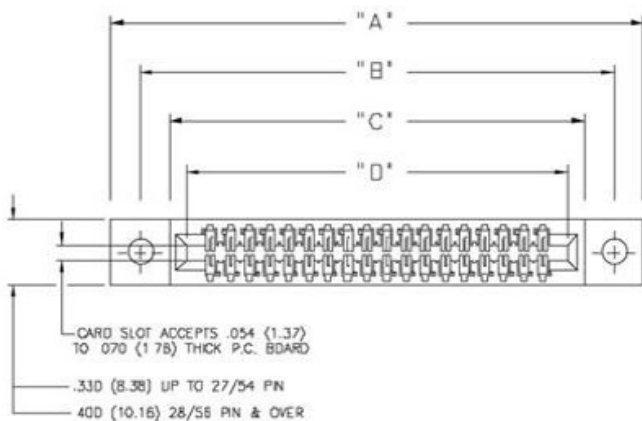

IN-CONTACT
POLARIZING KEY
P/N 321-240-328



BETWEEN CONTACT
POLARIZING KEY
P/N 341-240-318

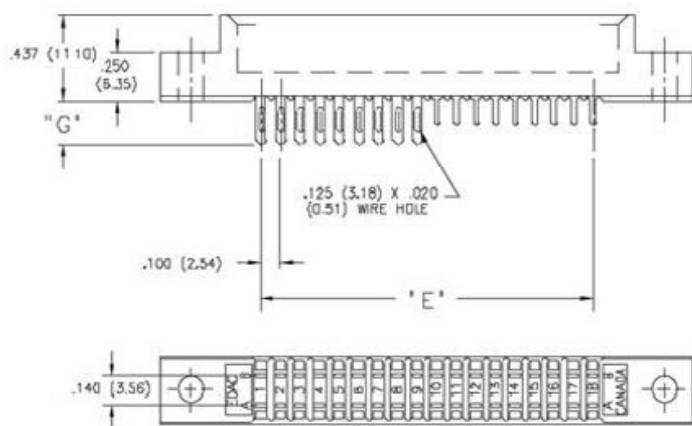

SECTION THROUGH
CONTACT POSITION

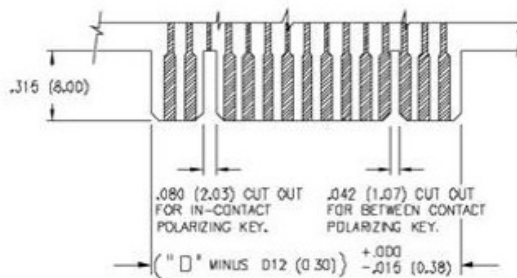
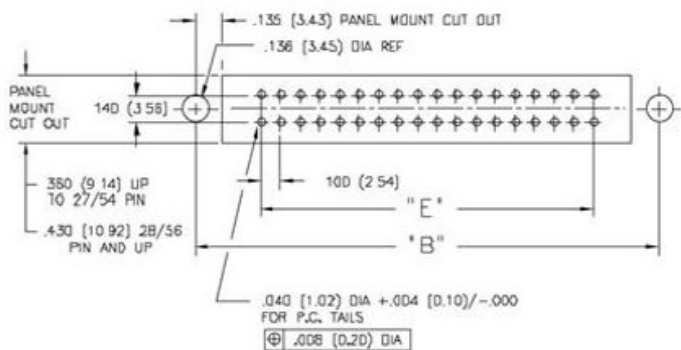
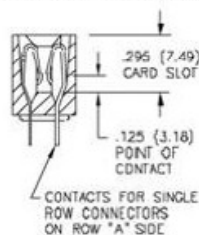

CONNECTOR MOUNTING PATTERN

RECOMMENDED DAUGHTER BOARD

| NUMBER OF CONTACTS | | "A" | | "B" | | "C" | | "D" | | "E" | |
|--------------------|------|-------|----------|-------|----------|-------|----------|-------|----------|-------|----------|
| Single | Dual | Inch | (mm) | Inch | (mm) | Inch | (mm) | Inch | (mm) | Inch | (mm) |
| 5 | 10 | 1.375 | (34.93) | 1.075 | (27.31) | .775 | (19.69) | .600 | (15.24) | .400 | (10.16) |
| 6 | 12 | 1.475 | (37.47) | 1.175 | (29.85) | .875 | (22.23) | .700 | (17.78) | .500 | (12.70) |
| 10 | 20 | 1.875 | (47.63) | 1.575 | (40.01) | 1.275 | (32.39) | 1.100 | (27.94) | .900 | (22.86) |
| 15 | 30 | 2.375 | (60.33) | 2.075 | (52.71) | 1.775 | (45.09) | 1.600 | (40.64) | 1.400 | (35.56) |
| 18 | 36 | 2.675 | (67.95) | 2.375 | (60.33) | 2.075 | (52.71) | 1.900 | (48.26) | 1.700 | (43.18) |
| 22 | 44 | 3.075 | (78.11) | 2.775 | (70.49) | 2.475 | (62.87) | 2.300 | (58.42) | 2.100 | (53.34) |
| 25 | 50 | 3.375 | (85.73) | 3.075 | (78.11) | 2.775 | (70.49) | 2.600 | (66.04) | 2.400 | (60.96) |
| 28 | 56 | 3.675 | (93.35) | 3.375 | (85.73) | 3.075 | (78.11) | 2.900 | (73.66) | 2.700 | (68.58) |
| 30 | 60 | 3.875 | (98.43) | 3.575 | (90.81) | 3.275 | (83.19) | 3.100 | (78.74) | 2.900 | (73.66) |
| 36 | 72 | 4.475 | (113.67) | 4.175 | (106.05) | 3.875 | (98.43) | 3.700 | (93.98) | 3.500 | (88.90) |
| 40 | 80 | 4.875 | (123.83) | 4.575 | (116.21) | 4.275 | (108.59) | 4.100 | (104.14) | 3.900 | (99.06) |
| 43 | 86 | 5.175 | (131.45) | 4.875 | (123.83) | 4.575 | (116.21) | 4.400 | (111.76) | 4.200 | (106.68) |
| 50 | 100 | 5.875 | (149.23) | 5.575 | (141.61) | 5.275 | (133.99) | 5.100 | (129.54) | 4.900 | (124.46) |
| 60 | 120 | 6.875 | (174.63) | 6.575 | (167.01) | 6.275 | (159.39) | 6.100 | (154.94) | 5.900 | (149.86) |

Dimensions of Other Connector Sizes are Listed

342/392 SERIES CARD EDGE CONNECTOR

.100" (2.54mm) Contact Spacing

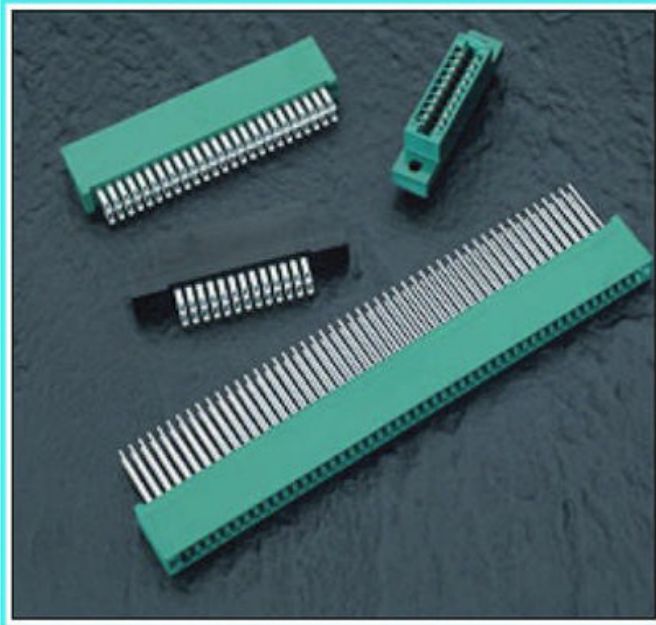

FEATURES

- UL Recognized
- .100 (2.54) Contact Spacing x .200 (5.08) Row Spacing
- Accepts .062 (1.57) Nominal Thickness P.C. Board
- High Profile Insulator Body, .590 (14.99)
- Contact Termination Options include P.C. Tail, Wire Hole, Wire Wrap, 90 Degree & Extender Board Bends
- Single or Dual Row Configurations
- Variety of Mounting Options
- Accepts Between Contact and In-Contact Polarizing Keys
- Design based on Requirements of HE 901 Specification

SPECIFICATIONS

- ◆ Insulator Material: Thermoplastic Polyester, UL 94V-0
- ◆ Contact Material: Copper Alloy
- ◆ Contact Plating: Gold on the Mating Area, Tin on the Contact Tails, Nickel Underplate
- ◆ Current Rating: 3 Amperes Continuous
- ◆ Contact Resistance: 10 Milliohms Maximum
- ◆ Dielectric Withstanding Voltage: 1200 V AC rms at Sea Level Between Adjacent Contacts
- ◆ Insulation Resistance: 5000 Megohms Minimum
- ◆ Operating Temperature: -65 to +105 Degrees C
- ◆ Insertion Force: 16 oz (4.45 N) Maximum per Contact Pair when Tested with a .070 (1.78) Thick Gauge
- ◆ Withdrawal Force: 1 oz (0.28 N) Minimum per Contact Pair when Tested with a .054 (1.37) Thick Gauge

342/392 SERIES ORDERING CODE

Example Part Number **342 - 100 - 541 - 2 02**

Series _____
 Total Number of Contacts _____
 Contact Code _____
 Contact Rows _____
 Mounting Options _____

| Series | Insulator Colour |
|--------|------------------|
| 342 | Green |
| 392 | Black |

| Total Number of Contacts ¹ | Contact Rows |
|---------------------------------------|--------------|
| 005, 006,...058 | Single Row |
| 010, 012,...116 | Dual Row |

| Contact Code ^{2,3} | Description & Tail Size | Tail Length "G" |
|-----------------------------|---|-----------------|
| 500 | Wire Hole .050 x .025 (1.27 x 0.64) | .270 (6.86) |
| 520 | P.C. Tail .030 x .018 (0.76 x 0.46) | .185 (4.70) |
| 521 | P.C. Tail .025 Square (0.64 Square) | .160 (4.06) |
| 523 | P.C. Tail .025 Square (0.64 Square) | .400 (10.16) |
| 524 | P.C. Tail .018 Square (0.46 Square) | .185 (4.70) |
| 540 | Wire Wrap .025 Square (0.64 Square) | .570 (14.48) |
| 541 | Wire Wrap .025 Square (0.64 Square) | .760 (19.30) |
| 542 | Wire Wrap .025 Square (0.64 Square) | .655 (16.64) |
| 544 | Wire Wrap .050 x .025 (1.27 x 0.64) | .760 (19.30) |
| 555 | Extender Board Bend (Code 500 Contacts) | |
| 556 | Extender Board Bend (Code 520 Contacts) | |
| 558 | 90 Degree Bend (Code 541 Contacts) | |
| 559 | 90 Degree Bend (Code 541 Contacts) | |
| 560 | Extender Board Bend (Code 523 Contacts) | |

| Contact Rows | Description |
|--------------|-------------|
| 1 | Single Row |
| 2 | Dual Row |

| Mounting Options ⁴ | Description |
|-------------------------------|--------------------------------------|
| 01 | No Mounting Lugs |
| 02 | .128 (3.25) Wide Mounting Slots |
| 03 | .116 (2.95) I.D. Floating Eyelets |
| 04 | .156 (3.96) Dia. Mounting Holes |
| 07 | M3-0.5 Metric Threaded Inserts |
| 08 | #4-40 Unified Threaded Inserts |
| 12 | .128 (3.25) Dia. Side Mounting Holes |

Ordering Code Notes

- 1) All connector sizes up to 58 contacts single row / 116 contacts dual row are available upon request.
- 2) The 500 contact code is only available in the 342 series. Green polyphenylene sulphide insulator material will be supplied.
- 3) For details of the extender board and 90 degree bends, refer to page 61.
- 4) For details of the mounting options, refer to page 63.

CARD EDGE CONNECTOR SERIES 342/392

Contact Spacing .100" (2.54mm)

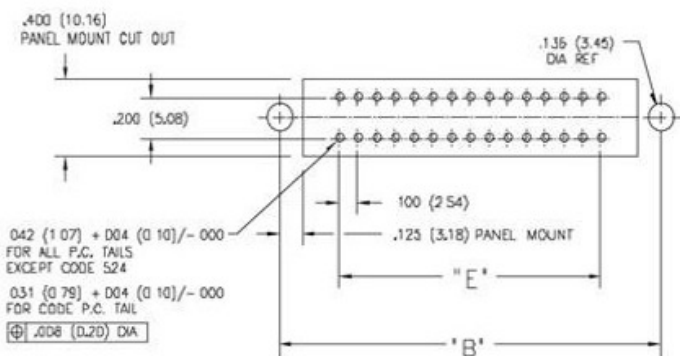
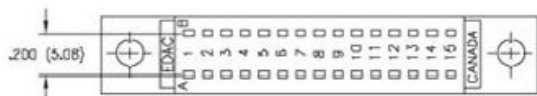
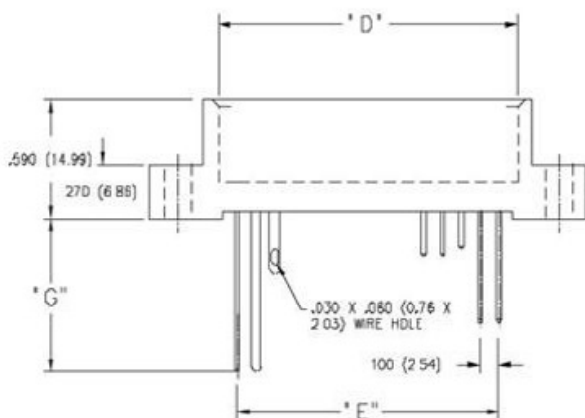
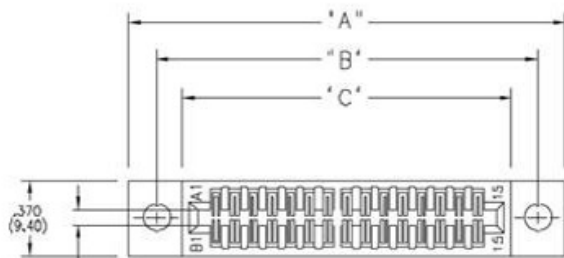

CONNECTOR MOUNTING PATTERN

IN-CONTACT
POLARIZING KEY

P/N 345-240-328



BETWEEN CONTACT
POLARIZING KEY

P/N 342-240-318

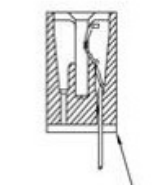

LETTER "A" SIDE
OF CONNECTOR
SINGLE ROW

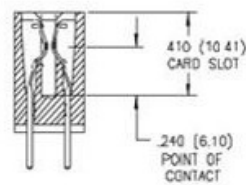

DUAL ROW

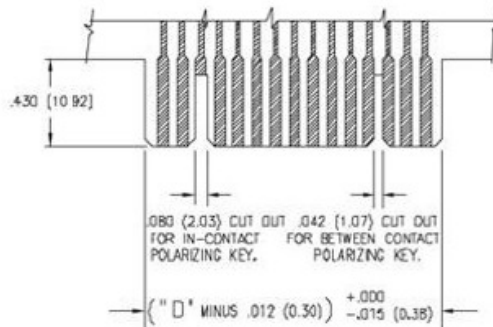

RECOMMENDED DAUGHTER BOARD

| NUMBER OF CONTACTS | | "A" | | "B" | | "C" | | "D" | | "E" | |
|--------------------|------|-------|----------|-------|----------|-------|----------|-------|----------|-------|----------|
| Single | Dual | Inch | (mm) | Inch | (mm) | Inch | (mm) | Inch | (mm) | Inch | (mm) |
| 5 | 10 | 1.300 | (33.02) | 1.022 | (25.96) | .746 | (18.95) | .600 | (15.24) | .400 | (10.16) |
| 10 | 20 | 1.800 | (45.72) | 1.522 | (38.66) | 1.246 | (31.65) | 1.100 | (27.94) | .900 | (22.86) |
| 13 | 26 | 2.100 | (53.34) | 1.822 | (46.28) | 1.546 | (39.27) | 1.400 | (35.56) | 1.200 | (30.48) |
| 15 | 30 | 2.300 | (58.42) | 2.022 | (51.36) | 1.746 | (44.35) | 1.600 | (40.64) | 1.400 | (35.56) |
| 18 | 36 | 2.600 | (66.04) | 2.322 | (58.98) | 2.046 | (51.97) | 1.900 | (48.26) | 1.700 | (43.18) |
| 22 | 44 | 3.000 | (76.20) | 2.722 | (69.14) | 2.446 | (62.13) | 2.300 | (58.42) | 2.100 | (53.34) |
| 25 | 50 | 3.300 | (83.82) | 3.022 | (76.76) | 2.746 | (69.75) | 2.600 | (66.04) | 2.400 | (60.96) |
| 30 | 60 | 3.800 | (96.52) | 3.522 | (89.46) | 3.246 | (82.45) | 3.100 | (78.74) | 2.900 | (73.66) |
| 31 | 62 | 3.900 | (99.06) | 3.622 | (92.00) | 3.346 | (84.99) | 3.200 | (81.28) | 3.000 | (76.20) |
| 35 | 70 | 4.300 | (109.22) | 4.022 | (102.16) | 3.746 | (95.15) | 3.600 | (91.44) | 3.400 | (86.36) |
| 36 | 72 | 4.400 | (111.76) | 4.122 | (104.70) | 3.846 | (97.69) | 3.700 | (93.98) | 3.500 | (88.90) |
| 43 | 86 | 5.100 | (129.54) | 4.822 | (122.48) | 4.546 | (115.47) | 4.400 | (111.76) | 4.200 | (106.68) |
| 50 | 100 | 5.800 | (147.32) | 5.522 | (140.26) | 5.246 | (133.25) | 5.100 | (129.54) | 4.900 | (124.46) |
| 58 | 116 | 6.600 | (167.64) | 6.322 | (160.58) | 6.046 | (153.57) | 5.900 | (149.86) | 5.700 | (144.78) |

Dimensions of Other Connector Sizes are Listed

395 SERIES (98 PIN-AT) CARD EDGE CONNECTOR

.100" (2.54mm) Contact Spacing

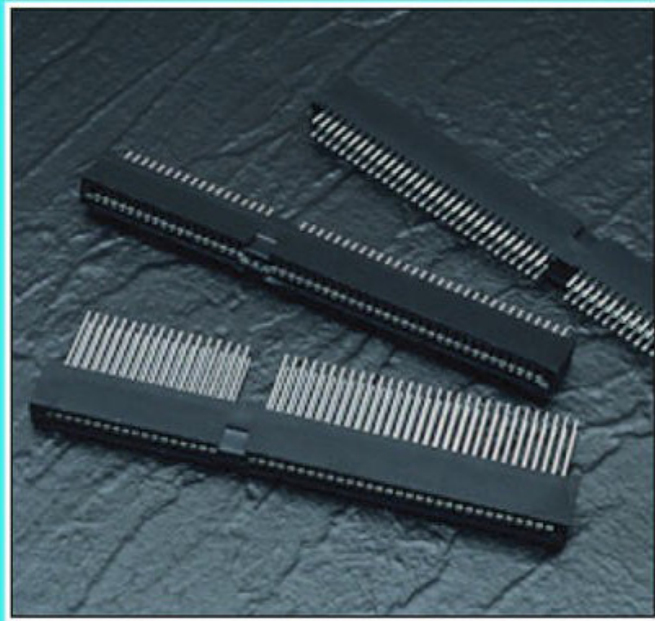

395 SERIES (98 PIN-AT) ORDERING CODE

Example Part Number **395 - 098 - 520 - 300**

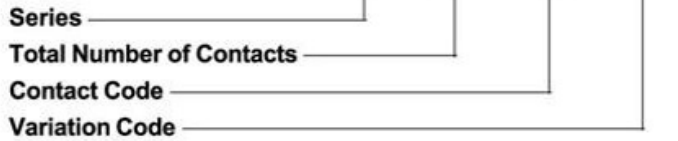

Series 395

Total Number of Contacts 098

Contact Code

See 345/395 Series for Available Contact Options and "G" Dimension
Code 500 Contact is Not Standard for 398-AT Connector

Variation Code

300

Description

Card Slot Barrier Divides the 98 Contacts into Groups of 62 and 36

FEATURES

- CSA Approved and UL Recognized
- For IBM-AT Industry Standard Architecture
- .100 (2.54) Contact Spacing x .200 (5.08) Row Spacing
- Accepts .062 (1.57) Nominal Thickness P.C. Board
- High Profile Insulator Body, .600 (15.24), Divided into Groups of 62 and 36 Contacts
- Contact Termination Options include P.C. Tail, Wire Wrap, 90 Degree & Extender Board Bends
- Accepts Between Contact and In-Contact Polarizing Keys

SPECIFICATIONS

- ◆ Insulator Material: Thermoplastic Polyester, UL 94V-0, Colour: Black
- ◆ Contact Material: Copper Alloy
- ◆ Contact Plating: Gold on the Mating Area, Tin on the Contact Tails, Nickel Underplate
- ◆ Current Rating: 3 Amperes Continuous
- ◆ For Additional Specifications, Refer to 345/395 Series

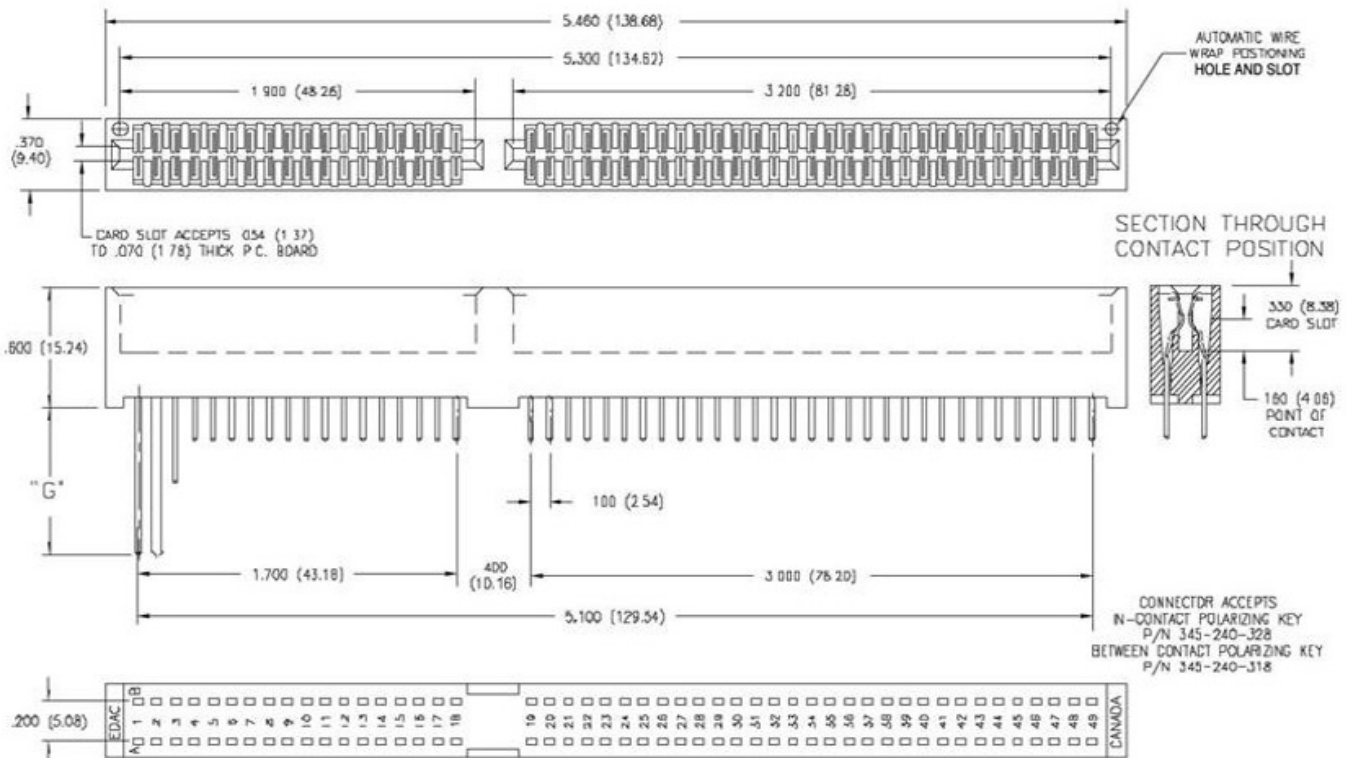

CARD EDGE CONNECTOR SERIES 340

Contact Spacing .100" (2.54mm)

340 SERIES ORDERING CODE

Example Part Number **340 - 050 - 523 - 2 02**

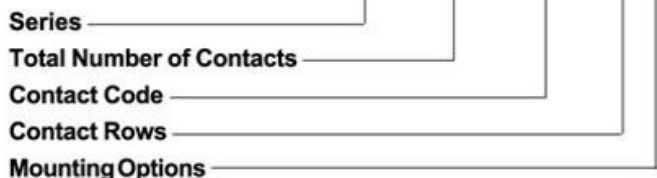

Series 340

| Total Number of Contacts ¹ | Contact Rows |
|---------------------------------------|--------------|
| 005, 006,...060 | Single Row |
| 010, 012,...120 | Dual Row |

Contact Code
See 345/395 Series for Available Contact Options and "G" Dimension

| Contact Rows | Description |
|--------------|-------------|
| 1 | Single Row |
| 2 | Dual Row |

| Mounting Options ² | Description |
|-------------------------------|---------------------------------|
| 01 | No Mounting Lugs |
| 02 | .128 (3.25) Dia. Mounting Holes |
| 04 | .156 (3.96) Dia. Mounting Holes |

Ordering Code Notes

- 1) All connector sizes up to 60 contacts single row / 120 contacts dual row are available upon request.
- 2) For details of the mounting options, refer to page 62.

FEATURES

- .100 (2.54) Contact Spacing x .200 (5.08) Row Spacing
- Accepts .062 (1.57) Nominal Thickness P.C. Board
- High Profile Insulator Body, .600 (15.24)
- Contact Termination Options include P.C. Tail, Wire Hole, Wire Wrap, 90 Degree & Extender Board Bends
- Single or Dual Row Configurations
- Accepts Between Contact and In-Contact Polarizing Keys

SPECIFICATIONS

- ◆ Insulator Material: Thermoplastic Polyester, UL 94V-0, Colour: Green
- ◆ Contact Material: Copper Alloy
- ◆ Contact Plating: Gold on the Mating Area, Tin on the Contact Tails, Nickel Underplate
- ◆ Current Rating: 3 Amperes Continuous
- ◆ For Additional Specifications, Refer to 345/395 Series

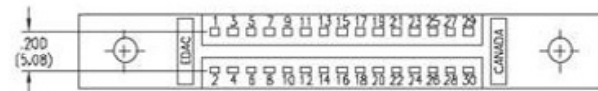
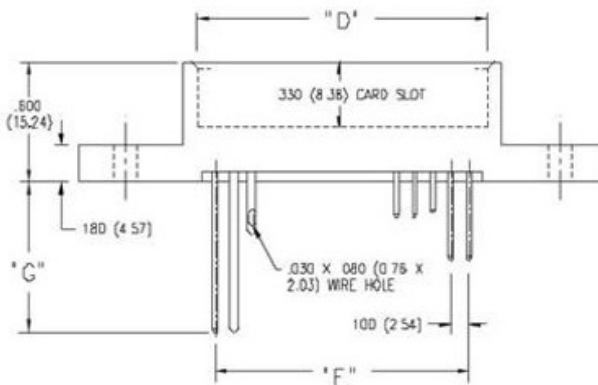
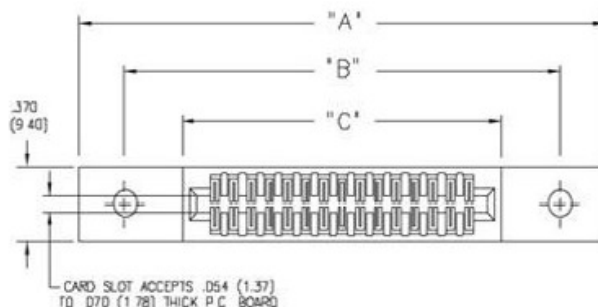
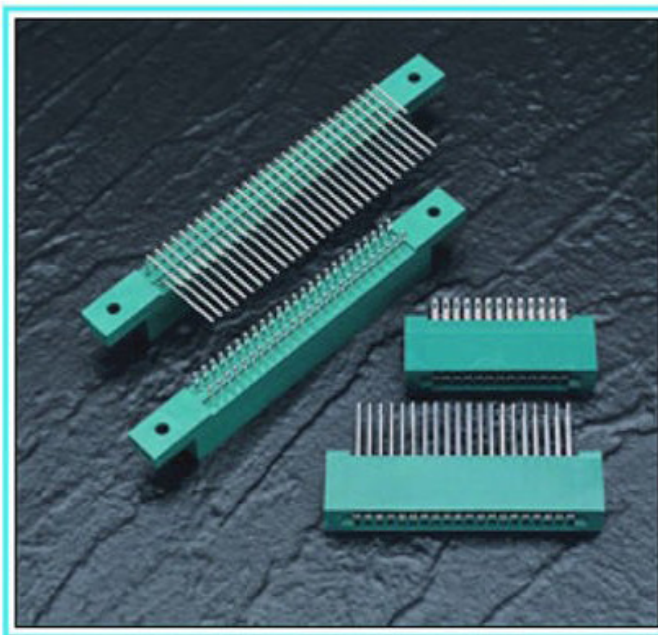

REFER TO 345/395 SERIES FOR CROSS SECTION AND POLARIZING KEY INFORMATION

| NUMBER OF CONTACTS | | "A" | | "B" | | "C" | | "D" | | "E" | |
|--------------------|------|-------|----------|-------|----------|-------|----------|-------|----------|-------|----------|
| Single | Dual | Inch | (mm) | Inch | (mm) | Inch | (mm) | Inch | (mm) | Inch | (mm) |
| 5 | 10 | 1.900 | (48.26) | 1.400 | (35.56) | .965 | (24.51) | .610 | (15.49) | .400 | (10.16) |
| 18 | 36 | 3.200 | (81.28) | 2.700 | (68.58) | 2.265 | (57.53) | 1.910 | (48.51) | 1.700 | (43.18) |
| 30 | 60 | 4.400 | (111.76) | 3.900 | (99.06) | 3.465 | (88.01) | 3.110 | (78.99) | 2.900 | (73.66) |
| 43 | 86 | 5.700 | (144.78) | 5.200 | (132.08) | 4.765 | (121.03) | 4.410 | (112.01) | 4.200 | (106.68) |
| 60 | 120 | 7.400 | (187.96) | 6.900 | (175.26) | 6.465 | (164.21) | 6.110 | (155.19) | 5.900 | (149.86) |

Dimensions of Other Connector Sizes are Listed

325 SERIES CARD EDGE CONNECTOR

.100" (2.54mm) Contact Spacing, Accepts .125" (3.18mm) Thick Board

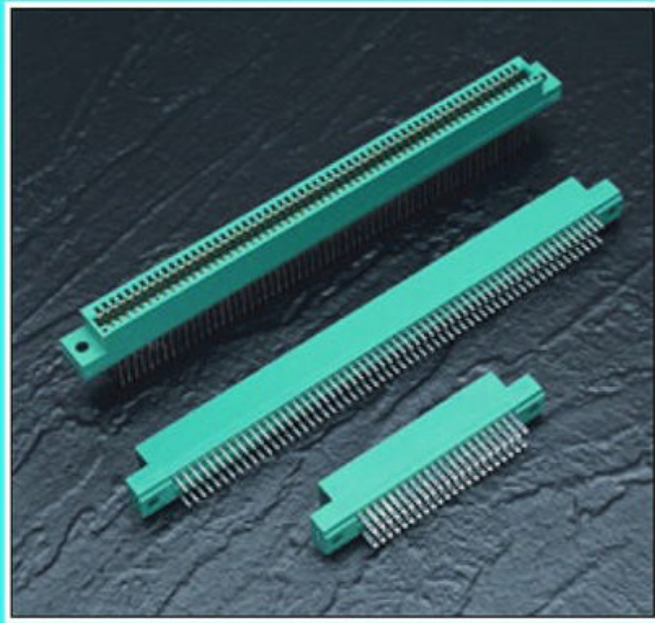

325 SERIES ORDERING CODE

Example Part Number **325 - 122 - 520 - 2 09**

Series _____
 Total Number of Contacts _____
 Contact Code _____
 Contact Rows _____
 Mounting Options _____

Series 325

| Total Number of Contacts ¹ | Contact Rows |
|---------------------------------------|--------------|
| 005, 006,...061 | Single Row |
| 010, 012,...122 | Dual Row |

| Contact Code | Description & Tail Size | Tail Length "G" |
|--------------|-------------------------------------|-----------------|
| 500 | Wire Hole .050 x .025 (1.27 x 0.64) | .260 (6.60) |
| 520 | P.C. Tail .025 Square (0.64 Square) | .175 (4.45) |
| 540 | Wire Wrap .025 Square (0.64 Square) | .560 (14.22) |

| Contact Rows | Description |
|--------------|-------------|
| 1 | Single Row |
| 2 | Dual Row |

| Mounting Options ² | Description |
|-------------------------------|---------------------------------|
| 01 | No Mounting Lugs |
| 07 | M3-0.5 Metric Threaded Inserts |
| 08 | #4-40 Unified Threaded Inserts |
| 09 | .160 (4.06) Dia. Mounting Holes |

Ordering Code Notes

- 1) All connector sizes up to 61 contacts single row / 122 contacts dual row are available upon request.
- 2) For details of the mounting options, refer to page 63.

FEATURES

- .100 (2.54) Contact Spacing x .300 (7.62) Row Spacing
- Accepts .125 (3.18) Nominal Thickness P.C. Board
- High Profile Insulator Body, .600 (15.24)
- Contact Termination Options include P.C. Tail, Wire Hole & .025 (0.64) Square Wire Wrap
- Single or Dual Row Configurations
- Variety of Mounting Options
- Accepts In-Contact Polarizing Keys
- Automatic Wire Wrap Positioning Holes

SPECIFICATIONS

- ◆ Insulator Material: Polyphenylene Sulphide, UL 94V-0, Colour: Green
- ◆ Contact Material: Copper Alloy
- ◆ Contact Plating: Gold on the Mating Area, Tin on the Contact Tails, Nickel Underplate
- ◆ Current Rating: 3 Amperes Continuous
- ◆ Contact Resistance: 10 Milliohms Maximum
- ◆ Dielectric Withstanding Voltage: 1200 V AC rms at Sea Level Between Adjacent Contacts
- ◆ Insulation Resistance: 5000 Megohms Minimum
- ◆ Operating Temperature: -65 to +125 Degrees C
- ◆ Insertion Force: 16 oz (4.45 N) Maximum per Contact Pair when Tested with a .135 (3.43) Thick Gauge
- ◆ Withdrawal Force: 1 oz (0.28 N) Minimum per Contact Pair when Tested with a .115 (2.92) Thick Gauge

CARD EDGE CONNECTOR SERIES 325

Accepts .125" (3.18mm) Thick Board, Contact Spacing .100" (2.54mm)

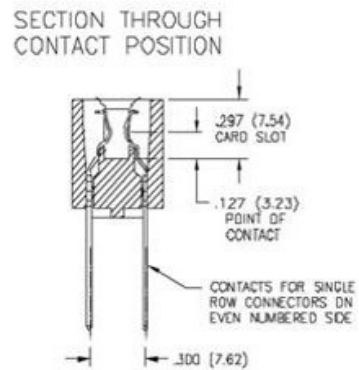
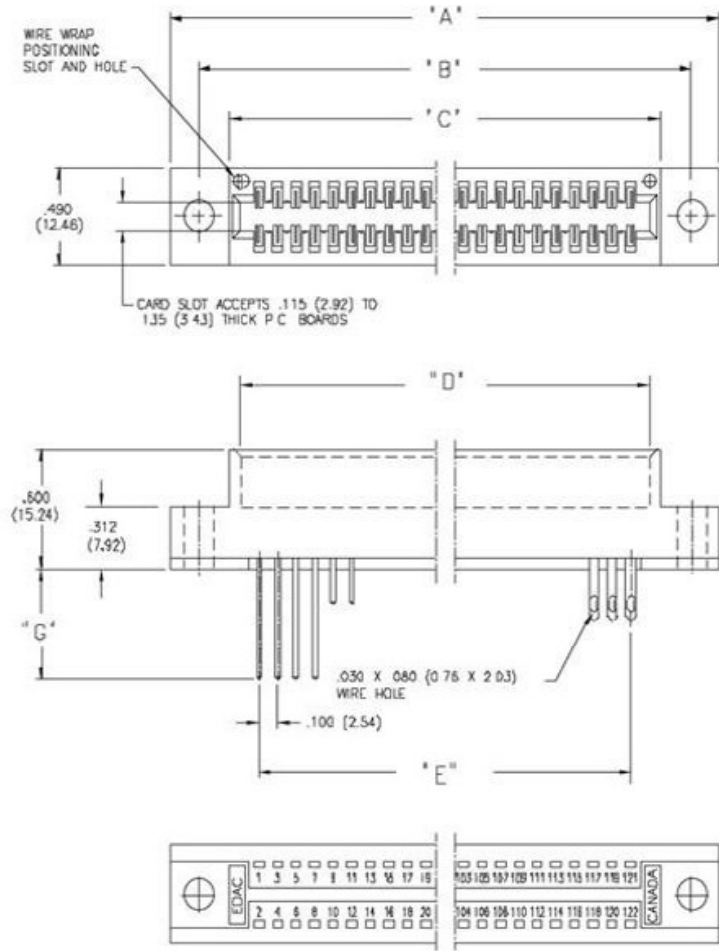

IN-CONTACT POLARIZING KEY
P/N 325-240-328

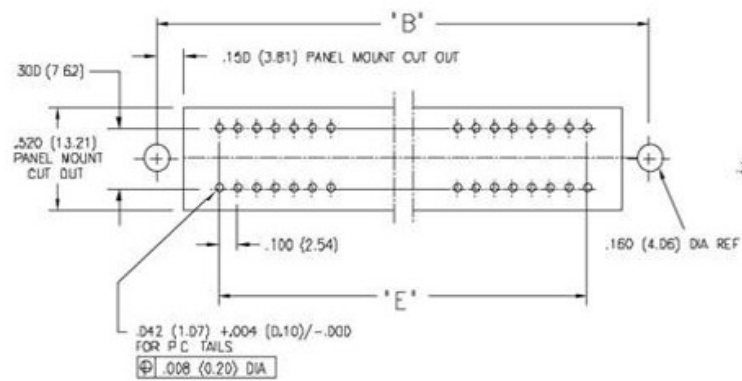
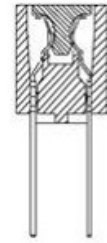

CONNECTOR MOUNTING PATTERN

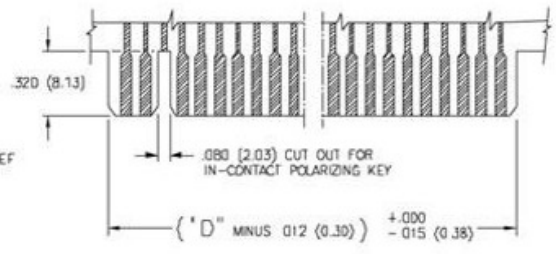

RECOMMENDED DAUGHTER BOARD

| NUMBER OF CONTACTS | | "A" | | "B" | | "C" | | "D" | | "E" | |
|--------------------|------|-------|----------|-------|----------|-------|----------|-------|----------|-------|----------|
| Single | Dual | Inch | (mm) | Inch | (mm) | Inch | (mm) | Inch | (mm) | Inch | (mm) |
| 5 | 10 | 1.355 | (34.42) | 1.056 | (26.82) | .722 | (18.34) | .600 | (15.24) | .400 | (10.16) |
| 15 | 30 | 2.355 | (59.82) | 2.056 | (52.22) | 1.722 | (43.74) | 1.600 | (40.64) | 1.400 | (35.56) |
| 18 | 36 | 2.655 | (67.44) | 2.356 | (59.84) | 2.022 | (51.36) | 1.900 | (48.26) | 1.700 | (43.18) |
| 22 | 44 | 3.055 | (77.60) | 2.756 | (70.00) | 2.422 | (61.52) | 2.300 | (58.42) | 2.100 | (53.34) |
| 25 | 50 | 3.355 | (85.22) | 3.056 | (77.62) | 2.722 | (69.14) | 2.600 | (66.04) | 2.400 | (60.96) |
| 30 | 60 | 3.855 | (97.92) | 3.556 | (90.32) | 3.222 | (81.84) | 3.100 | (78.74) | 2.900 | (73.66) |
| 36 | 72 | 4.455 | (113.16) | 4.156 | (105.56) | 3.822 | (97.08) | 3.700 | (93.98) | 3.500 | (88.90) |
| 40 | 80 | 4.855 | (123.32) | 4.556 | (115.72) | 4.222 | (107.24) | 4.100 | (104.14) | 3.900 | (99.06) |
| 43 | 86 | 5.155 | (130.94) | 4.856 | (123.34) | 4.522 | (114.86) | 4.400 | (111.76) | 4.200 | (106.68) |
| 50 | 100 | 5.855 | (148.72) | 5.556 | (141.12) | 5.222 | (132.64) | 5.100 | (129.54) | 4.900 | (124.46) |
| 61 | 122 | 6.955 | (176.66) | 6.656 | (169.06) | 6.322 | (160.58) | 6.200 | (157.48) | 6.000 | (152.40) |

Dimensions of Other Connector Sizes are Listed

339/389 SERIES CARD EDGE CONNECTOR

.100" (2.54mm) Contact Spacing (Bellows Contacts)

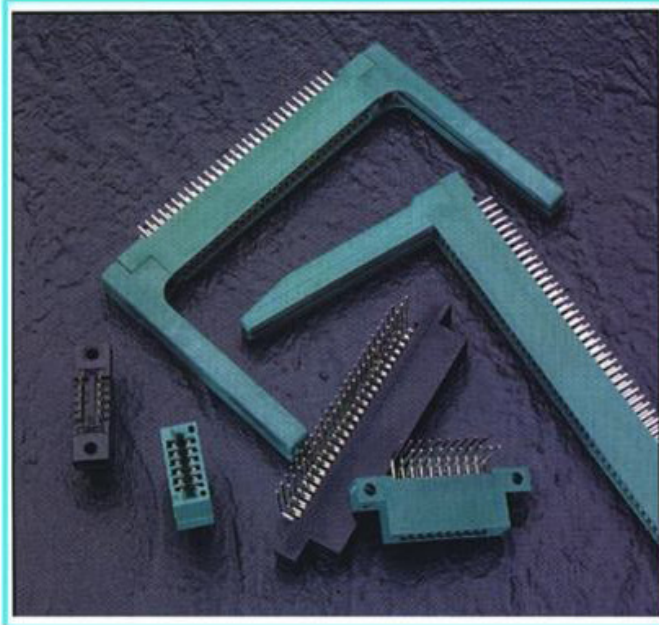

FEATURES

- CSA Approved and UL Recognized
- .100 (2.54) Contact Spacing x .200 (5.08) Row Spacing
- Accepts .062 (1.57) Nominal Thickness P.C. Board
- High Profile Insulator Body, .600 (15.24)
- Contact Termination Options include P.C. Tail, Wire Wrap, 90 Degree & Extender Board Bends
- Round P.C. Tails available to fit .036 (.091) diameter holes
- Single or Dual Row Configurations
- Large Variety of Mounting Options, Flush or Offset Lugs
- Pre-assembled Card Guides Available
- Accepts Between Contact and In-Contact Polarizing Keys
- Automatic Wire Wrap Positioning Holes

SPECIFICATIONS

- ◆ Insulator Material: Thermoplastic Polyester, UL 94V-0
- ◆ Contact Material: Copper Alloy
- ◆ Contact Plating: Gold on the Mating Area, Tin on the Contact Tails, Nickel Underplate
- ◆ Current Rating: 3 Amperes Continuous
- ◆ Contact Resistance: 10 Milliohms Maximum
- ◆ Dielectric Withstanding Voltage: 1200 V AC rms at Sea Level Between Adjacent Contacts
- ◆ Insulation Resistance: 5000 Megohms Minimum
- ◆ Operating Temperature: -65 to +105 Degrees C
- ◆ Insertion Force: 16 oz (4.45 N) Maximum per Contact Pair when Tested with a .070 (1.78) Thick Gauge
- ◆ Withdrawal Force: 1 oz (0.28 N) Minimum per Contact Pair when Tested with a .054 (1.37) Thick Gauge

339/389 SERIES ORDERING CODE

Example Part Number **339 - 050 - 520 - 2 02**

Series _____
 Total Number of Contacts _____
 Contact Code _____
 Contact Rows and Insulator Style _____
 Mounting Options _____

Series Insulator Colour

339 Green
 389 Black

Total Number of Contacts ¹

005, 006, ..., 072 Single Row
 010, 012, ..., 144 Dual Row

| Contact Code ^{2,3} | Description & Tail Size | Tail Length "G" |
|-----------------------------|-------------------------------------|-----------------|
| 521 | P.C. Tail .025 Square (0.64 Square) | .150 (3.81) |
| 523 | P.C. Tail .025 Square (0.64 Square) | .186 (4.72) |
| 524 | P.C. Tail .025 Square (0.64 Square) | .376 (9.55) |
| 540 | Wire Wrap .025 Square (0.64 Square) | .539 (13.69) |
| 541 | Wire Wrap .025 Square (0.64 Square) | .556 (14.12) |
| 556 | Extender Board Bend | |
| 558 | 90 Degree Bend | |
| 559 | 90 Degree Bend | |
| 560 | Extender Board Bend | |

Contact Rows and Insulator Style

Description

| | |
|---|-------------------------------------|
| 1 | Single Row, Flush Mounting Lugs |
| 2 | Dual Row, Flush Mounting Lugs |
| 4 | Single Row, .110 (2.79) Offset Lugs |
| 5 | Dual Row, .110 (2.79) Offset Lugs |
| 6 | Single Row, .170 (4.32) Offset Lugs |
| 8 | Dual Row, .170 (4.32) Offset Lugs |

Mounting Options ^{4,5}

Description

| | |
|----|--|
| 01 | No Mounting Lugs |
| 02 | .128 (3.25) Dia. Mounting Holes |
| 03 | .116 (2.95) I.D. Floating Eyelets |
| 04 | .156 (3.96) Dia. Mounting Holes |
| 07 | M3-0.5 Metric Threaded Inserts |
| 08 | #4-40 Unified Threaded Inserts |
| 12 | .128 (3.25) Dia. Side Mounting Holes |
| 58 | .468 (11.89) Offset Card Guides |
| 78 | In-line Card Guides 2.750 (69.85) Long |
| 88 | In-Line Card Guides 1.250 (31.75) Long |

Ordering Code Notes

- 1) All connector sizes up to 72 contacts single row / 144 contacts dual row are available upon request.
- 2) For details of the extender board and 90 degree bends, refer to page 61.
- 3) For lugless connectors, code 01 mounting, specify contact row codes 1 or 2.
- 4) For details of the mounting options, refer to page 63.

CARD EDGE CONNECTOR SERIES 339/389

Contact Spacing .100" (2.54mm) (Bellows Contacts)

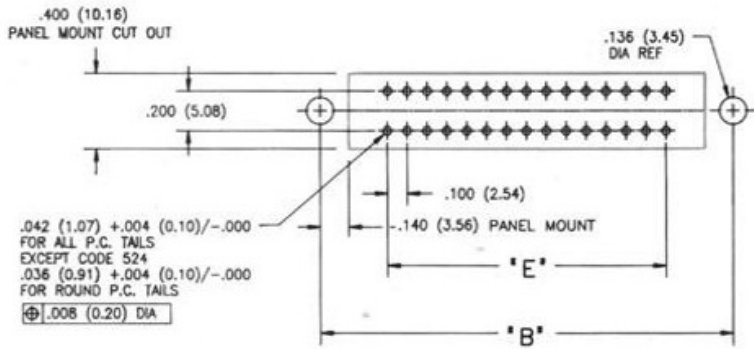
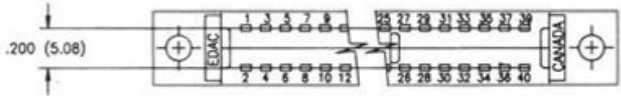
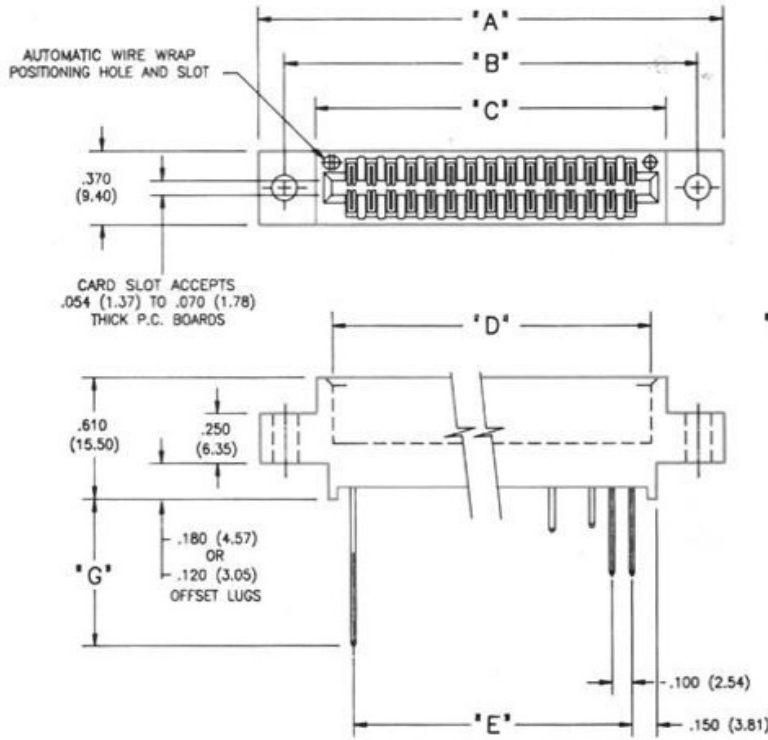

CONNECTOR MOUNTING PATTERN

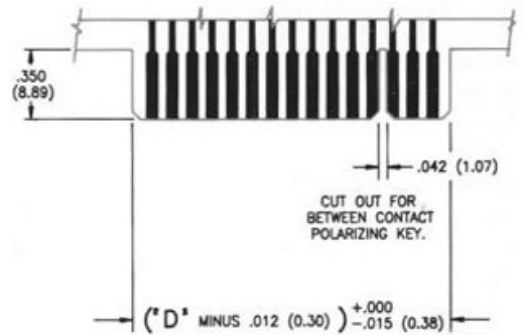

RECOMMENDED DAUGHTER BOARD

| NUMBER OF CONTACTS | | "A" | | "B" | | "C" | | "D" | | "E" | |
|--------------------|------|-------|----------|-------|----------|-------|----------|-------|----------|-------|----------|
| Single | Dual | Inch | (mm) | Inch | (mm) | Inch | (mm) | Inch | (mm) | Inch | (mm) |
| 5 | 10 | 1.335 | (33.91) | 1.075 | (27.31) | .760 | (19.30) | .600 | (15.24) | .400 | (10.16) |
| 10 | 20 | 1.835 | (46.61) | 1.575 | (40.01) | 1.260 | (32.00) | 1.100 | (27.94) | .900 | (22.86) |
| 13 | 26 | 2.135 | (54.23) | 1.875 | (47.63) | 1.560 | (39.62) | 1.400 | (35.56) | 1.200 | (30.48) |
| 15 | 30 | 2.335 | (59.31) | 2.075 | (52.71) | 1.760 | (44.70) | 1.600 | (40.64) | 1.400 | (35.56) |
| 18 | 36 | 2.635 | (66.93) | 2.375 | (60.33) | 2.060 | (52.32) | 1.900 | (48.26) | 1.700 | (43.18) |
| 22 | 44 | 3.035 | (77.09) | 2.775 | (70.49) | 2.460 | (62.48) | 2.300 | (58.42) | 2.100 | (53.34) |
| 25 | 50 | 3.335 | (84.71) | 3.075 | (78.11) | 2.760 | (70.10) | 2.600 | (66.04) | 2.400 | (60.96) |
| 30 | 60 | 3.835 | (97.41) | 3.575 | (90.81) | 3.260 | (82.80) | 3.100 | (78.74) | 2.900 | (73.66) |
| 31 | 62 | 3.935 | (99.95) | 3.675 | (93.35) | 3.360 | (85.34) | 3.200 | (81.28) | 3.000 | (76.20) |
| 36 | 72 | 4.435 | (112.65) | 4.175 | (106.05) | 3.860 | (98.04) | 3.700 | (93.98) | 3.500 | (88.90) |
| 43 | 86 | 5.135 | (130.43) | 4.875 | (123.83) | 4.560 | (115.82) | 4.400 | (111.76) | 4.200 | (106.68) |
| 50 | 100 | 5.835 | (148.21) | 5.575 | (141.61) | 5.260 | (133.60) | 5.100 | (129.54) | 4.900 | (124.46) |
| 60 | 120 | 6.835 | (173.61) | 6.575 | (167.01) | 6.260 | (159.00) | 6.100 | (154.94) | 5.900 | (149.86) |
| 72 | 144 | 8.035 | (204.09) | 7.775 | (197.49) | 7.460 | (189.48) | 7.300 | (185.42) | 7.100 | (180.34) |

Dimensions of Other Connector Sizes are Listed

346/396 SERIES CARD EDGE CONNECTOR

.125" (3.18mm) Contact Spacing

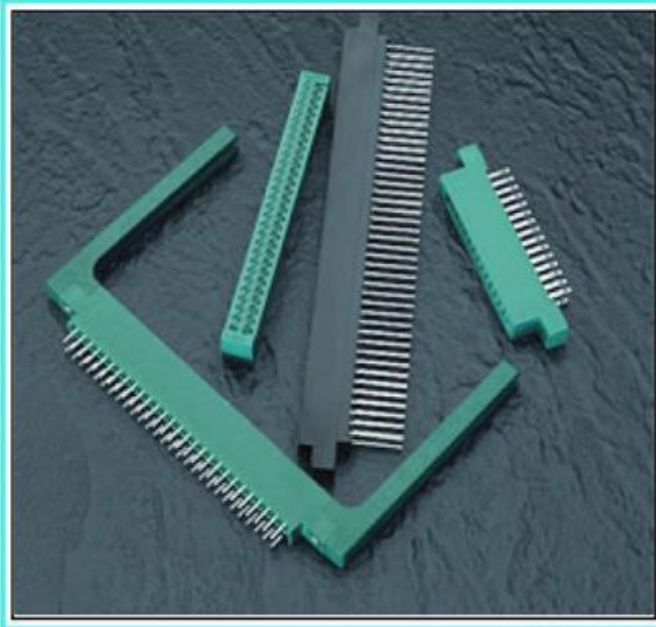

FEATURES

- CSA Approved and UL Recognized
- .125 (3.18) Contact Spacing x .250 (6.35) Row Spacing
- Accepts .062 (1.57) Nominal Thickness P.C. Board
- High Profile Insulator Body, .600 (15.24)
- Contact Termination Options include P.C. Tail, Wire Hole, .025 (0.64) Square Wire Wrap, 90 Degree & Extender Board Bends
- Single or Dual Row Configurations
- Large Variety of Mounting Options, Flush or Offset Lugs
- Pre-assembled Card Guides Available
- Accepts Between Contact and In-Contact Polarizing Keys
- Automatic Wire Wrap Positioning Holes

SPECIFICATIONS

- ◆ Insulator Material: Thermoplastic Polyester, UL 94V-0
- ◆ **Contact Material: Copper Alloy**
- ◆ Contact Plating: Gold on the Mating Area, Tin on the Contact Tails, Nickel Underplate
- ◆ Current Rating: 3 Amperes Continuous
- ◆ Contact Resistance: 10 Milliohms Maximum
- ◆ Dielectric Withstanding Voltage: 1500 V AC rms at Sea Level Between Adjacent Contacts
- ◆ Insulation Resistance: 5000 Megohms Minimum
- ◆ Operating Temperature: -65 to +105 Degrees C
- ◆ Insertion Force: 16 oz (4.45 N) Maximum per Contact Pair when Tested with a .070 (1.78) Thick Gauge
- ◆ Withdrawal Force: 1 oz (0.28 N) Minimum per Contact Pair when Tested with a .054 (1.37) Thick Gauge

346/396 SERIES ORDERING CODE

Example Part Number **346 - 056 - 540 - 8 02**

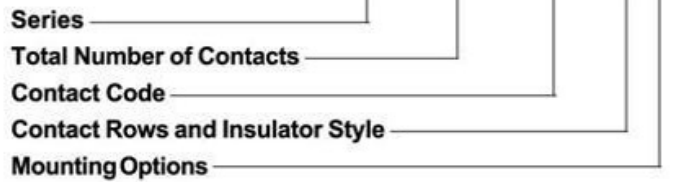

| Series | Insulator Colour |
|--------|------------------|
| 346 | Green |
| 396 | Black |

| Total Number of Contacts ¹ | Contact Rows |
|---------------------------------------|--------------|
| 005, 006,...050 | Single Row |
| 010, 012,...100 | Dual Row |

| Contact Code ^{2,3} | Description & Tail Size | Tail Length "G" |
|-----------------------------|---|-----------------|
| 500 | Wire Hole .050 x .025 (1.27 x 0.64) | .260 (6.60) |
| 520 | P.C. Tail .025 Square (0.64 Square) | .175 (4.45) |
| 521 | P.C. Tail .025 Square (0.64 Square) | .150 (3.81) |
| 522 | P.C. Tail .025 Square (0.64 Square) | .440(11.18) |
| 526 | P.C. Tail .025 Square (0.64 Square) | .350 (8.89) |
| 540 | Wire Wrap .025 Square (0.64 Square) | .560(14.22) |
| 541 | Wire Wrap .025 Square (0.64 Square) | .750(19.05) |
| 555 | Extender Board Bend (Code 500 Contacts) | |
| 556 | Extender Board Bend (Code 520 Contacts) | |
| 558 | 90 Degree Bend (Code 541 Contacts) | |
| 559 | 90 Degree Bend (Code 541 Contacts) | |
| 560 | Extender Board Bend (Code 526 Contacts) | |

| Contact Rows and Insulator Style ⁴ | Description |
|---|-------------------------------------|
| 1 | Single Row, Flush Mounting Lugs |
| 2 | Dual Row, Flush Mounting Lugs |
| 6 | Single Row, .170 (4.32) Offset Lugs |
| 8 | Dual Row, .170 (4.32) Offset Lugs |

| Mounting Options ^{5,6,7} | Description |
|-----------------------------------|--------------------------------------|
| 01 | No Mounting Lugs |
| 02 | .128 (3.25) Dia. Mounting Holes |
| 03 | .116 (2.95) I.D. Floating Eyelets |
| 04 | .156 (3.96) Dia. Mounting Holes |
| 07 | M3-0.5 Metric Threaded Inserts |
| 08 | #4-40 Unified Threaded Inserts |
| 12 | .128 (3.25) Dia. Side Mounting Holes |
| 58 | .468 (11.89) Offset Card Guides |
| 78 | In-Line Card Guides |

Ordering Code Notes

- 1) All connector sizes up to 50 contacts single row / 100 contacts dual row are available upon request.
- 2) The 500 contact code is only available in the 346 series. Green polyphenylene sulphide insulator material will be supplied.
- 3) For details of the extender board and 90 degree bends, refer to page 61.
- 4) Consult with Edac regarding connectors with a .420 (10.67) card slot depth.
- 5) For lugless connectors, code 01 mounting, specify contact row codes 1 or 2.
- 6) In-line card guides are only available with offset mounting lugs.
- 7) For details of the mounting options, refer to page 63.

CARD EDGE CONNECTOR SERIES 346/396

Contact Spacing .125" (3.18mm)

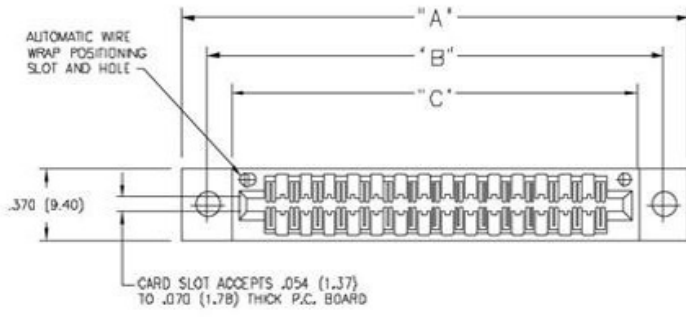

SECTIONS THROUGH CONTACT POSITION

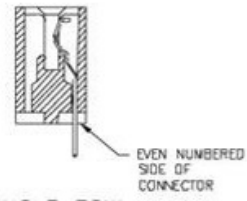

SINGLE ROW

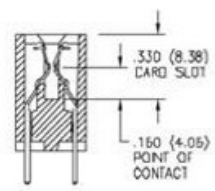
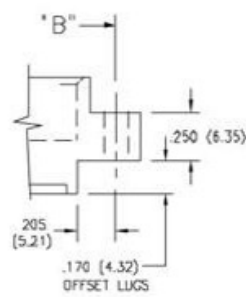
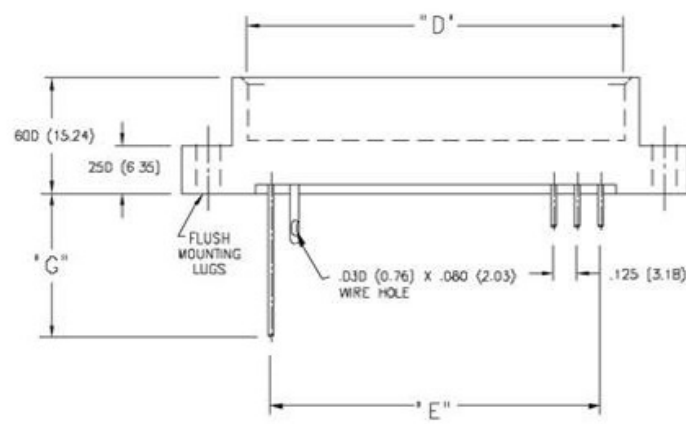

DUAL ROW

IN-CONTACT POLARIZING KEY

P/N 345-240-328

BETWEEN CONTACT POLARIZING KEY

P/N 305-240-318

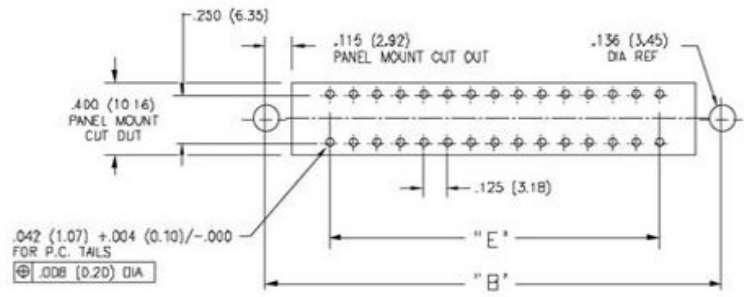
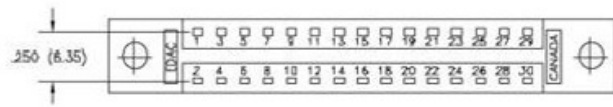

CONNECTOR MOUNTING PATTERN

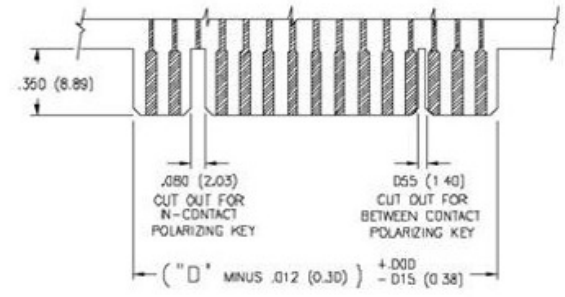

RECOMMENDED DAUGHTER BOARD

| NUMBER OF CONTACTS | | "A" | | "B" | | "C" | | "D" | | "E" | |
|--------------------|------|-------|----------|-------|----------|-------|----------|-------|----------|-------|----------|
| Single | Dual | Inch | (mm) | Inch | (mm) | Inch | (mm) | Inch | (mm) | Inch | (mm) |
| 5 | 10 | 1.435 | (36.45) | 1.170 | (29.72) | .910 | (23.11) | .750 | (19.05) | .500 | (12.70) |
| 6 | 12 | 1.560 | (39.62) | 1.295 | (32.89) | 1.035 | (26.29) | .875 | (22.23) | .625 | (15.88) |
| 10 | 20 | 2.060 | (52.32) | 1.795 | (45.59) | 1.535 | (38.99) | 1.375 | (34.93) | 1.125 | (28.58) |
| 15 | 30 | 2.685 | (68.20) | 2.420 | (61.47) | 2.160 | (54.86) | 2.000 | (50.80) | 1.750 | (44.45) |
| 18 | 36 | 3.060 | (77.72) | 2.795 | (70.99) | 2.535 | (64.39) | 2.375 | (60.33) | 2.125 | (53.98) |
| 22 | 44 | 3.560 | (90.42) | 3.295 | (83.69) | 3.035 | (77.09) | 2.875 | (73.03) | 2.625 | (66.68) |
| 25 | 50 | 3.935 | (99.95) | 3.670 | (93.22) | 3.410 | (86.61) | 3.250 | (82.55) | 3.000 | (76.20) |
| 30 | 60 | 4.560 | (115.82) | 4.295 | (109.09) | 4.035 | (102.49) | 3.875 | (98.43) | 3.625 | (92.08) |
| 31 | 62 | 4.685 | (119.00) | 4.420 | (112.27) | 4.160 | (105.66) | 4.000 | (101.60) | 3.750 | (95.25) |
| 35 | 70 | 5.185 | (131.70) | 4.920 | (124.97) | 4.660 | (118.36) | 4.500 | (114.30) | 4.250 | (107.95) |
| 36 | 72 | 5.310 | (134.87) | 5.045 | (128.14) | 4.785 | (121.54) | 4.625 | (117.48) | 4.375 | (111.13) |
| 40 | 80 | 5.810 | (147.57) | 5.545 | (140.84) | 5.285 | (134.24) | 5.125 | (130.18) | 4.875 | (123.83) |
| 43 | 86 | 6.185 | (157.10) | 5.920 | (150.37) | 5.660 | (143.76) | 5.500 | (139.70) | 5.250 | (133.35) |
| 50 | 100 | 7.060 | (179.32) | 6.795 | (172.59) | 6.535 | (165.99) | 6.375 | (161.93) | 6.125 | (155.58) |

Dimensions of Other Connector Sizes are Listed

305/315/355 SERIES CARD EDGE CONNECTOR

.156" (3.96mm) Contact Spacing



FEATURES

- 305/355 Series CSA Approved and UL Recognized
- 315 Series UL Recognized
- .156 (3.96) Contact Spacing x .140 (3.56) Row Spacing
- Accepts .062 (1.57) Nominal Thickness P.C. Board
- Low Profile Insulator Body, .460 (11.68)
- Contact Termination Options include P.C. Tail, Wire Hole & Extender Board Bends
- Large Variety of Mounting Options
- Pre-assembled Card Guides Available
- Accepts Between Contact and In-Contact Polarizing Keys

SPECIFICATIONS

- ◆ Insulator Material: Thermoplastic Polyester, UL 94V-0
- ◆ **Contact Material: Copper Alloy**
- ◆ Contact Plating: Gold on the Mating Area, Tin on the Contact Tails, Nickel Underplate
- ◆ Current Rating: 5 Amperes Continuous
- ◆ Contact Resistance: 10 Milliohms Maximum
- ◆ Dielectric Withstanding Voltage: 1800 V AC rms at Sea Level Between Adjacent Contacts
- ◆ Insulation Resistance: 5000 Megohms Minimum
- ◆ Operating Temperature: -65 to +105 Degrees C
- ◆ Insertion Force: 16 oz (4.45 N) Maximum per Contact Pair when Tested with a .070 (1.78) Thick Gauge
- ◆ Withdrawal Force: 1 oz (0.28 N) Minimum per Contact Pair when Tested with a .054 (1.37) Thick Gauge

305/315/355 SERIES ORDERING CODE

Example Part Number **305 - 056 - 521 - 2 04**

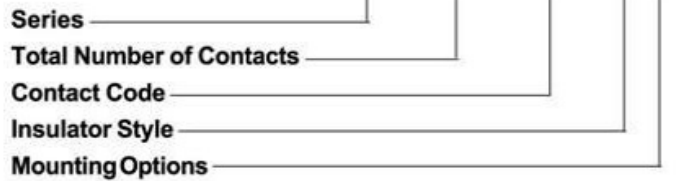

| Series | Insulator Colour | Card Slot Length |
|--------|------------------|-----------------------------------|
| 305 | Green | Standard Length per MIL-C-21097 |
| 315 | Green | .020 (0.51) Shorter than Standard |
| 355 | Black | Standard Length per MIL-C-21097 |

| Total Number of Contacts ¹ | Contact Rows |
|---------------------------------------|--------------|
| 012, 014,...086 | Dual Row |

| Contact Code ^{2,3} | Description & Tail Size | Tail Length "G" |
|-----------------------------|---|-----------------|
| 500 | Wire Hole .087 x .013 (2.21 x 0.33) | .282 (7.16) |
| 520 | P.C. Tail .046 x .013 (1.17 x 0.33) | .213 (5.41) |
| 521 | P.C. Tail .046 x .013 (1.17 x 0.33) | .125 (3.18) |
| 555 | Extender Board Bend (Code 500 Contacts) | |
| 556 | Extender Board Bend (Code 520 Contacts) | |

| Insulator Style ⁴ | Description |
|------------------------------|-----------------------------|
| 2 | .295 (7.49) Card Slot Depth |
| 5 | .330 (8.38) Card Slot Depth |

| Mounting Options ⁵ | Description |
|-------------------------------|-----------------------------------|
| 01 | No Mounting Lugs |
| 02 | .128 (3.25) Dia. Mounting Holes |
| 03 | .116 (2.95) I.D. Floating Eyelets |
| 04 | .156 (3.96) Dia. Mounting Holes |
| 07 | M3-0.5 Metric Threaded Inserts |
| 08 | #4-40 Unified Threaded Inserts |
| 58 | .468 (11.89) Offset Card Guides |
| 68 | .344 (8.74) Offset Card Guides |
| 78 | In-Line Card Guides |

Ordering Code Notes

- 1) All connector sizes up to 86 contacts dual row are available upon request.
- 2) Consult with Edac regarding single row configuration and wire wrap tail options.
- 3) For details of the extender board bends, refer to page 61.
- 4) Insulator style code 5 is available for the 305 and 355 series upon request.
- 5) For details of the mounting options, refer to page 63.

CARD EDGE CONNECTOR SERIES 305/315/355

Contact Spacing .156" (3.96mm)

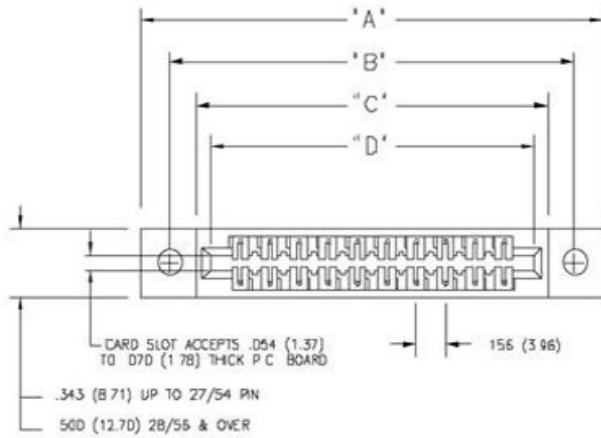

IN-CONTACT
POLARIZING KEY
P/N 307-240-328



BETWEEN CONTACT
POLARIZING KEY
P/N 306-240-318



SECTIONS THROUGH CONTACT POSITION

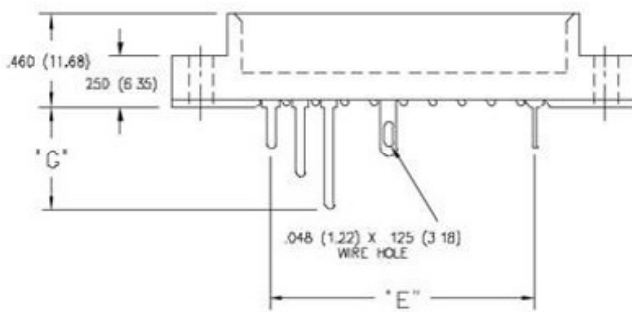

INSULATOR STYLE
CODE 2



INSULATOR STYLE
CODE 5

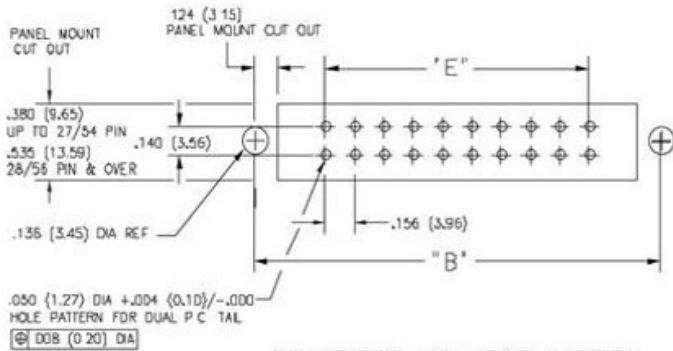
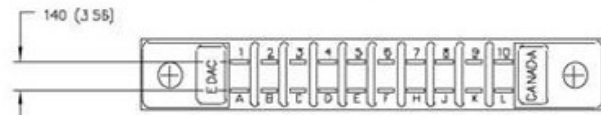

CONNECTOR MOUNTING PATTERN

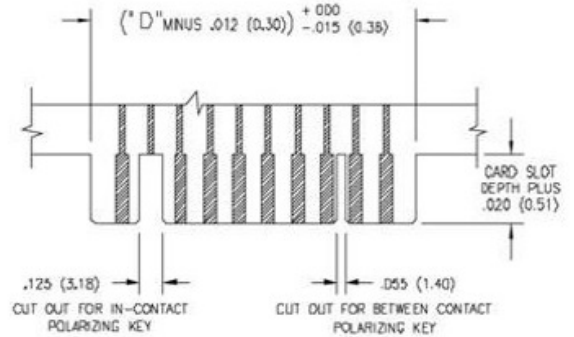

RECOMMENDED DAUGHTER BOARD

| NUMBER OF CONTACTS | "A" | | "B" | | "C" | | "D" | | "E" | | | |
|--------------------|-------|----------|-------|----------|-------|----------|----------|----------|-------|----------|-------|----------|
| | Inch | (mm) | Inch | (mm) | Inch | (mm) | 305, 355 | 315 | Inch | (mm) | | |
| Dual | | | | | | | | | | | | |
| 12 | 1.842 | (46.79) | 1.532 | (38.91) | 1.246 | (31.65) | 1.100 | (27.94) | 1.080 | (27.43) | .780 | (19.81) |
| 20 | 2.466 | (62.64) | 2.156 | (54.76) | 1.870 | (47.50) | 1.724 | (43.79) | 1.704 | (43.28) | 1.404 | (35.66) |
| 24 | 2.778 | (70.56) | 2.468 | (62.69) | 2.182 | (55.42) | 2.036 | (51.71) | 2.016 | (51.21) | 1.716 | (43.59) |
| 30 | 3.246 | (82.45) | 2.936 | (74.57) | 2.650 | (67.31) | 2.504 | (63.60) | 2.484 | (63.09) | 2.184 | (55.47) |
| 36 | 3.714 | (94.34) | 3.404 | (86.46) | 3.118 | (79.20) | 2.972 | (75.49) | 2.952 | (74.98) | 2.652 | (67.36) |
| 44 | 4.338 | (110.19) | 4.028 | (102.31) | 3.742 | (95.05) | 3.596 | (91.34) | 3.576 | (90.83) | 3.276 | (83.21) |
| 48 | 4.650 | (118.11) | 4.340 | (110.24) | 4.054 | (102.97) | 3.908 | (99.26) | 3.888 | (98.76) | 3.588 | (91.14) |
| 50 | 4.806 | (122.07) | 4.496 | (114.20) | 4.210 | (106.93) | 4.064 | (103.23) | 4.044 | (102.72) | 3.744 | (95.10) |
| 56 | 5.274 | (133.96) | 4.964 | (126.09) | 4.678 | (118.82) | 4.532 | (115.11) | 4.512 | (114.60) | 4.212 | (106.98) |
| 60 | 5.586 | (141.88) | 5.276 | (134.01) | 4.990 | (126.75) | 4.844 | (123.04) | 4.824 | (122.53) | 4.524 | (114.91) |
| 72 | 6.522 | (165.66) | 6.212 | (157.78) | 5.926 | (150.52) | 5.780 | (146.81) | 5.760 | (146.30) | 5.460 | (138.68) |
| 86 | 7.614 | (193.40) | 7.304 | (185.52) | 7.018 | (178.26) | 6.872 | (174.55) | 6.852 | (174.04) | 6.552 | (166.42) |

Dimensions of Other Connector Sizes are Listed

306/316/356 SERIES CARD EDGE CONNECTOR

.156" (3.96mm) Contact Spacing



306/316/356 SERIES ORDERING CODE

Example Part Number **306 - 022 - 521 - 178**

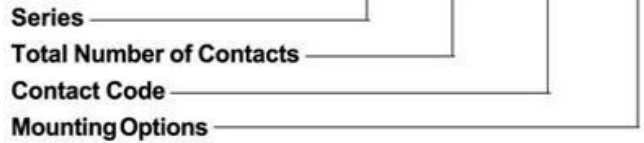

| Series | Insulator Colour | Card Slot Length |
|--------|------------------|-----------------------------------|
| 306 | Green | Standard Length per MIL-C-21097 |
| 316 | Green | .020 (0.51) Shorter than Standard |
| 356 | Black | Standard Length per MIL-C-21097 |

| Total Number of Contacts ¹ | Contact Row |
|---------------------------------------|-------------|
| 006, 007, ..., 043 | Centre Row |

| Contact Code ² | Description & Tail Size | Tail Length "G" |
|---------------------------|-------------------------------------|-----------------|
| 500 | Wire Hole .087 x .015 (2.21 x 0.38) | .282 (7.16) |
| 520 | P.C. Tail .046 x .015 (1.17 x 0.38) | .213 (5.41) |
| 521 | P.C. Tail .037 x .015 (0.94 x 0.38) | .125 (3.18) |

| Mounting Options ³ | Description |
|-------------------------------|-----------------------------------|
| 101 | No Mounting Lugs |
| 102 | .128 (3.25) Dia. Mounting Holes |
| 103 | .116 (2.95) I.D. Floating Eyelets |
| 104 | .156 (3.96) Dia. Mounting Holes |
| 107 | M3-0.5 Metric Threaded Inserts |
| 108 | #4-40 Unified Threaded Inserts |
| 158 | .468 (11.89) Offset Card Guides |
| 168 | .344 (8.74) Offset Card Guides |
| 178 | In-Line Card Guides |

FEATURES

- 306/356 Series CSA Approved and UL Recognized
- 316 Series UL Recognized
- .156 (3.96) Contact Spacing with Single Centreline Row
- Accepts .062 (1.57) Nominal Thickness P.C. Board
- Low Profile Insulator Body, .460 (11.68)
- Contact Termination Options include P.C. Tail & Wire Hole
- Large Variety of Mounting Options
- Pre-assembled Card Guides Available
- Accepts Between Contact and In-Contact Polarizing Keys

SPECIFICATIONS

- ◆ Insulator Material: Thermoplastic Polyester, UL 94V-0
- ◆ **Contact Material: Copper Alloy**
- ◆ Contact Plating: Gold on the Mating Area, Tin on the Contact Tails, Nickel Underplate
- ◆ Current Rating: 5 Amperes Continuous
- ◆ Contact Resistance: 10 Milliohms Maximum
- ◆ Dielectric Withstanding Voltage: 1800 V AC rms at Sea Level Between Adjacent Contacts
- ◆ Insulation Resistance: 5000 Megohms Minimum
- ◆ Operating Temperature: -65 to +105 Degrees C
- ◆ Insertion Force: 16 oz (4.45 N) Maximum per Contact when Tested with a .070 (1.78) Thick Gauge
- ◆ Withdrawal Force: 1 oz (0.28 N) Minimum per Contact when Tested with a .054 (1.37) Thick Gauge

Ordering Code Notes

- 1) All connector sizes up to 43 contacts centre row are available upon request.
- 2) For contacts with overall tin plating, change the first digit of the contact code from 5 to 4.
- 3) For details of the mounting options, refer to page 63.

CARD EDGE CONNECTOR SERIES 306/316/356

Contact Spacing .156" (3.96mm)

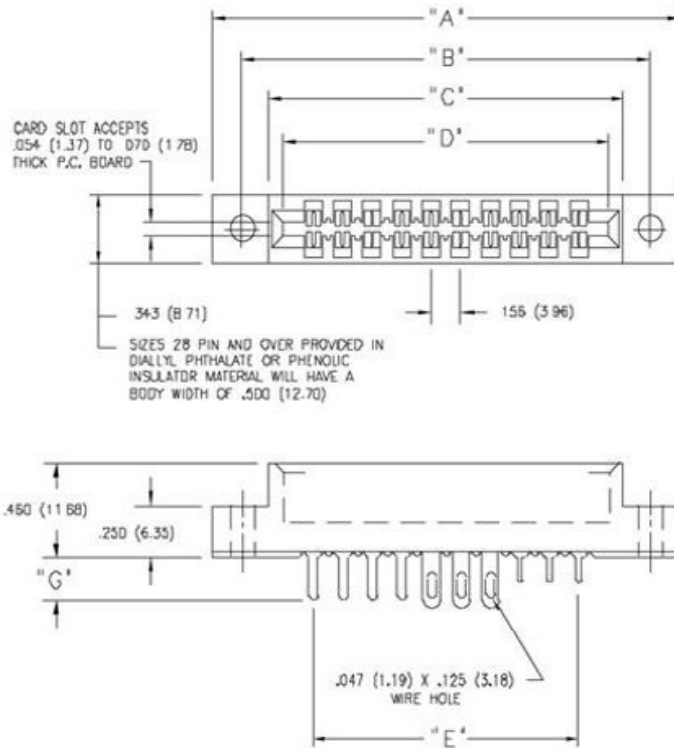

IN-CONTACT POLARIZING KEY
P/N 338-240-328

BETWEEN CONTACT POLARIZING KEY
P/N 306-240-318

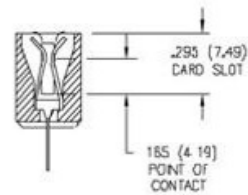

SECTION THROUGH CONTACT POSITION

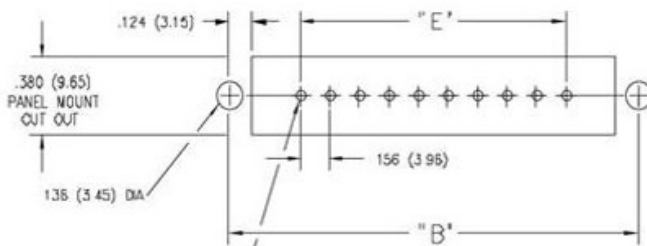

.050 (1.27) DIA +.004 (0.10) /-.000 FOR CODE S20 P.C. TAIL
.041 (1.04) DIA +.004 (0.10) /-.000 FOR CODE S21 P.C. TAIL

⌀ .008 (0.20) DIA

CONNECTOR MOUNTING PATTERN

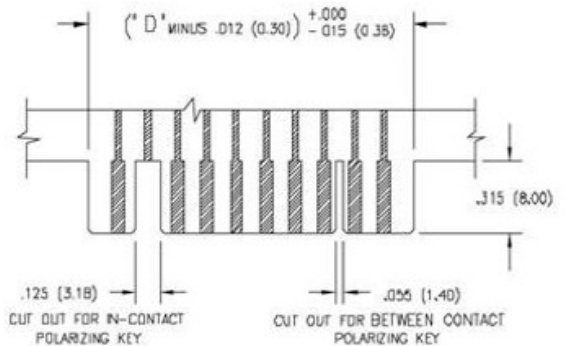

RECOMMENDED DAUGHTER BOARD

| NUMBER OF CONTACTS | "A" | | "B" | | "C" | | "D" | | "E" | | | |
|--------------------|-------|----------|-------|----------|-------|----------|----------|----------|-------|----------|-------|----------|
| | Inch | (mm) | Inch | (mm) | Inch | (mm) | 306, 356 | 316 | Inch | (mm) | | |
| Single | | | | | | | Inch | (mm) | Inch | (mm) | Inch | (mm) |
| 6 | 1.842 | (46.79) | 1.532 | (38.91) | 1.246 | (31.65) | 1.100 | (27.94) | 1.080 | (27.43) | .780 | (19.81) |
| 8 | 2.154 | (54.71) | 1.844 | (46.84) | 1.558 | (39.57) | 1.412 | (35.86) | 1.392 | (35.36) | 1.092 | (27.74) |
| 10 | 2.466 | (62.64) | 2.156 | (54.76) | 1.870 | (47.50) | 1.724 | (43.79) | 1.704 | (43.28) | 1.404 | (35.66) |
| 12 | 2.778 | (70.56) | 2.468 | (62.69) | 2.182 | (55.42) | 2.036 | (51.71) | 2.016 | (51.21) | 1.716 | (43.59) |
| 15 | 3.246 | (82.45) | 2.936 | (74.57) | 2.650 | (67.31) | 2.504 | (63.60) | 2.484 | (63.09) | 2.184 | (55.47) |
| 18 | 3.714 | (94.34) | 3.404 | (86.46) | 3.118 | (79.20) | 2.972 | (75.49) | 2.952 | (74.98) | 2.652 | (67.36) |
| 22 | 4.338 | (110.19) | 4.028 | (102.31) | 3.742 | (95.05) | 3.596 | (91.34) | 3.576 | (90.83) | 3.276 | (83.21) |
| 25 | 4.806 | (122.07) | 4.496 | (114.20) | 4.210 | (106.93) | 4.064 | (103.23) | 4.044 | (102.72) | 3.744 | (95.10) |
| 28 | 5.274 | (133.96) | 4.964 | (126.09) | 4.678 | (118.82) | 4.532 | (115.11) | 4.512 | (114.60) | 4.212 | (106.98) |
| 30 | 5.596 | (141.88) | 5.276 | (134.01) | 4.990 | (126.75) | 4.844 | (123.04) | 4.824 | (122.53) | 4.524 | (114.91) |
| 36 | 6.522 | (165.66) | 6.212 | (157.78) | 5.926 | (150.52) | 5.780 | (146.81) | 5.760 | (146.30) | 5.460 | (138.68) |
| 40 | 7.146 | (181.51) | 6.836 | (173.63) | 6.550 | (166.37) | 6.404 | (162.66) | 6.384 | (162.15) | 6.084 | (154.53) |
| 43 | 7.614 | (193.40) | 7.304 | (185.52) | 7.018 | (178.26) | 6.872 | (174.55) | 6.852 | (174.04) | 6.552 | (166.42) |

Dimensions of Other Connector Sizes are Listed

307/357 SERIES CARD EDGE CONNECTOR

.156" (3.96mm) Contact Spacing

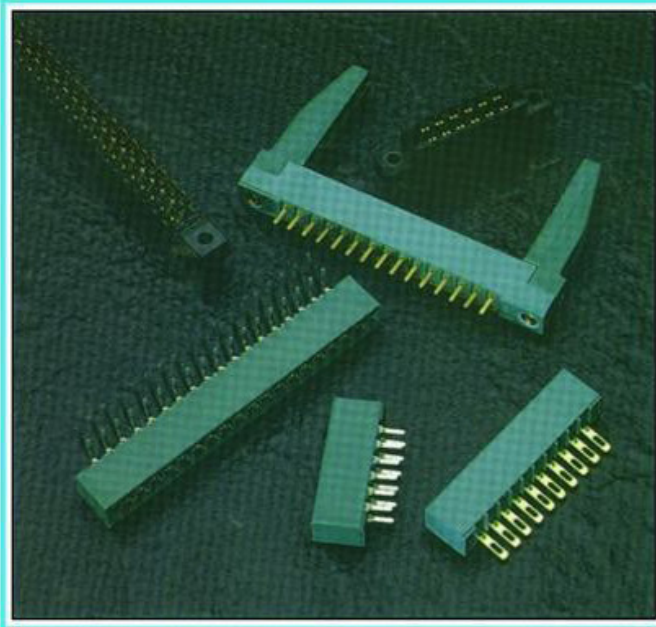

FEATURES

- CSA Approved and UL Recognized
- .156 (3.96) Contact Spacing x .200 (5.08) Row Spacing
- Accepts .062 (1.57) Nominal Thickness P.C. Board
- Low Profile Insulator Body, .460 (11.68)
- Contact Termination Options include P.C. Tail, Wire Hole, Wire Wrap, 90 Degree & Extender Board Bends
- Single or Dual Row Configurations
- Large Variety of Mounting Options
- Pre-assembled Card Guides Available
- Accepts Between Contact and In-Contact Polarizing Keys

SPECIFICATIONS

- ◆ Insulator Material: Thermoplastic Polyester, UL 94V-0
- ◆ **Contact Material: Copper Alloy**
- ◆ Contact Plating: Gold on the Mating Area, Tin on the Contact Tails, Nickel Underplate
- ◆ Current Rating: 5 Amperes Continuous
- ◆ Contact Resistance: 10 Milliohms Maximum
- ◆ Dielectric Withstanding Voltage: 1800 V AC rms at Sea Level Between Adjacent Contacts
- ◆ Insulation Resistance: 5000 Megohms Minimum
- ◆ Operating Temperature: -65 to +105 Degrees C
- ◆ Insertion Force: 16 oz (4.45 N) Maximum per Contact Pair when Tested with a .070 (1.78) Thick Gauge
- ◆ Withdrawal Force: 1 oz (0.28 N) Minimum per Contact Pair when Tested with a .054 (1.37) Thick Gauge

Ordering Code Notes

- 1) All connector sizes up to 44 contacts single row / 88 contacts dual row are available upon request.
- 2) For contacts with overall tin plating, change the first digit of the contact code from 5 to 4.
- 3) **Single row contacts that read both sides of the daughter board are copper alloy material with entire surface plated with gold over nickel underplate.**
- 4) For details of the extender board and 90 degree bends, refer to page 61.
- 5) Switching contacts, assembled in specific contact positions, are available upon request.
- 6) For details of the mounting options, refer to page 63.

307/357 SERIES ORDERING CODE

Example Part Number **307 - 044 - 520 - 2 02**

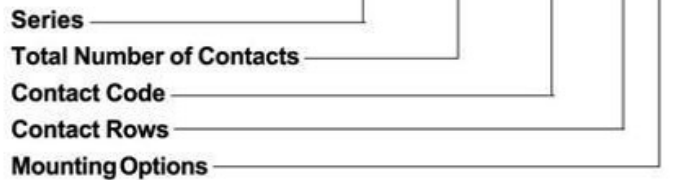

| Series | Insulator Colour |
|--------|------------------|
| 307 | Green |
| 357 | Black |

| Total Number of Contacts ¹ | Contact Rows |
|---------------------------------------|--------------|
| 006, 007, ..., 044 | Single Row |
| 012, 014, ..., 088 | Dual Row |

| Contact Code ^{2,3,4,5} | Description & Tail Size | Tail Length "G" |
|--|--|-----------------|
| <i>Single Row Contacts - Read One Side of Daughter Board</i> | | |
| 505 | Wire Hole .087 x .013 (2.21 x 0.33) | .282 (7.16) |
| 525 | P.C. Tail .046 x .013 (1.17 x 0.33) | .213 (5.41) |
| 527 | P.C. Tail .046 x .013 (1.17 x 0.33) | .358 (9.09) |
| 531 | P.C. Tail .023 x .013 (0.58 x 0.33) | .213 (5.41) |
| 545 | Wire Wrap .046 x .013 (1.17 x 0.33) | .708 (17.98) |
| 547 | Wire Wrap .046 x .013 (1.17 x 0.33) | .520 (13.21) |
| 558 | 90 Degree Bend (Code 545 Contacts) | |
| 559 | 90 Degree Bend (Code 527 Contacts) | |
| <i>Single Row Contacts - Read Both Sides of Daughter Board</i> | | |
| 501 | Wire Hole .089 x .014 (2.29 x 0.36) | .213 (5.41) |
| 521 | P.C. Tail .046 x .014 (1.17 x 0.36) | .213 (5.41) |
| 541 | Wire Wrap .046 x .014 (1.17 x 0.36) | .495 (12.57) |
| 553 | 90 Degree Bend (Code 521 Contacts) | |
| 554 | 90 Degree Bend (Code 501 Contacts) | |
| 557 | 90 Degree Bend (Code 541 Contacts) | |
| <i>Dual Row Contacts - Read Both Sides of Daughter Board</i> | | |
| 500 | Wire Hole .087 x .013 (2.21 x 0.33) | .282 (7.16) |
| 520 | P.C. Tail .046 x .013 (1.17 x 0.33) | .213 (5.41) |
| 522 | P.C. Tail .046 x .013 (1.17 x 0.33) | .358 (9.09) |
| 524 | P.C. Tail .023 x .013 (0.58 x 0.33) | .213 (5.41) |
| 540 | Wire Wrap .046 x .013 (1.17 x 0.33) | .708 (17.98) |
| 542 | Wire Wrap .046 x .013 (1.17 x 0.33) | .520 (13.21) |
| 555 | Extender Board Bend (Code 500 Contacts) | |
| 556 | Extender Board Bend (Code 520 Contacts) | |
| 558 | 90 Degree Bend (Code 522 and 540 Contacts) | |
| 559 | 90 Degree Bend (Code 522 and 540 Contacts) | |
| 560 | Extender Board Bend (Code 522 Contacts) | |

| Contact Rows | Description |
|--------------|-------------|
| 1 | Single Row |
| 2 | Dual Row |

| Mounting Options ⁶ | Description |
|-------------------------------|--------------------------------------|
| 01 | No Mounting Lugs |
| 02 | .128 (3.25) Dia. Mounting Holes |
| 03 | .116 (2.95) I.D. Floating Eyelets |
| 04 | .156 (3.96) Dia. Mounting Holes |
| 07 | M3-0.5 Metric Threaded Inserts |
| 08 | #4-40 Unified Threaded Inserts |
| 12 | .128 (3.25) Dia. Side Mounting Holes |
| 58 | .468 (11.89) Offset Card Guides |
| 68 | .344 (8.74) Offset Card Guides |
| 78 | In-Line Card Guides |

CARD EDGE CONNECTOR SERIES 307/357

Contact Spacing .156" (3.96mm)

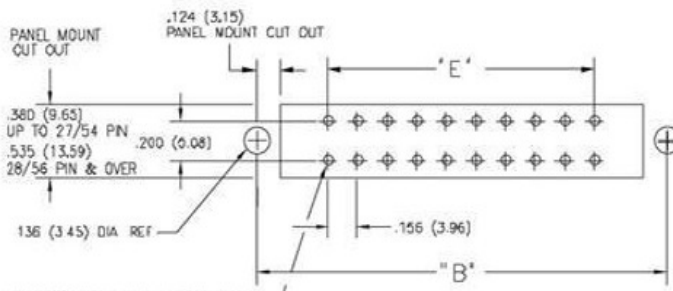
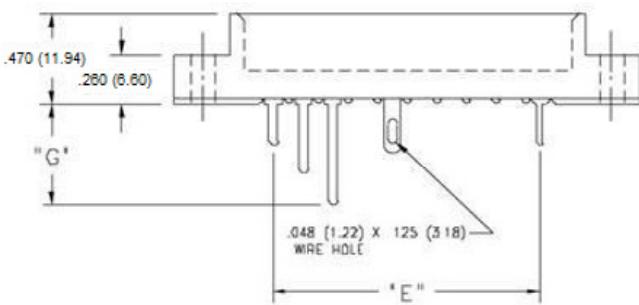
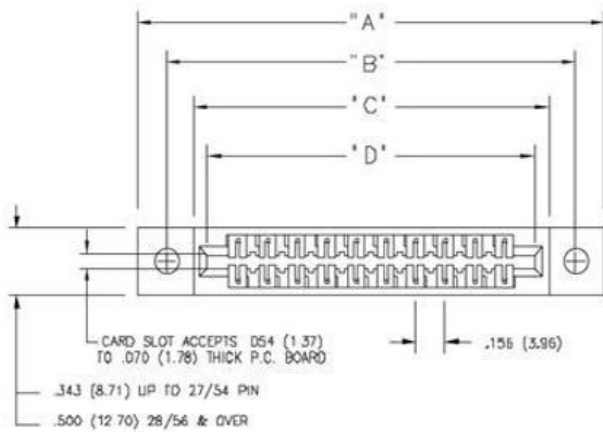

CONNECTOR MOUNTING PATTERN

IN-CONTACT POLARIZING KEY

P/N 307-240-328



BETWEEN CONTACT POLARIZING KEY

P/N 306-240-318



DUAL ROW CONTACTS

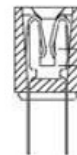

SINGLE ROW CONTACTS

READ ONE SIDE OF DAUGHTER BOARD

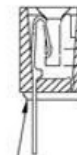

SINGLE ROW CONTACTS

READ BOTH SIDES OF DAUGHTER BOARD

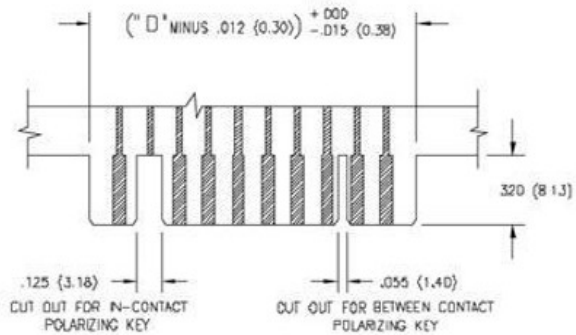
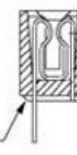

RECOMMENDED DAUGHTER BOARD

| NUMBER OF CONTACTS | | "A" | | "B" | | "C" | | "D" | | "E" | |
|--------------------|------|-------|----------|-------|----------|-------|----------|-------|----------|-------|----------|
| Single | Dual | Inch | (mm) | Inch | (mm) | Inch | (mm) | Inch | (mm) | Inch | (mm) |
| 6 | 12 | 1.842 | (46.79) | 1.532 | (38.91) | 1.246 | (31.65) | 1.100 | (27.94) | .780 | (19.81) |
| 8 | 16 | 2.154 | (54.71) | 1.844 | (46.84) | 1.558 | (39.57) | 1.412 | (35.86) | 1.092 | (27.74) |
| 10 | 20 | 2.466 | (62.64) | 2.156 | (54.76) | 1.870 | (47.50) | 1.724 | (43.79) | 1.404 | (35.66) |
| 12 | 24 | 2.778 | (70.56) | 2.468 | (62.69) | 2.182 | (55.42) | 2.036 | (51.71) | 1.716 | (43.59) |
| 15 | 30 | 3.246 | (82.45) | 2.936 | (74.57) | 2.650 | (67.31) | 2.504 | (63.60) | 2.184 | (55.47) |
| 18 | 36 | 3.714 | (94.34) | 3.404 | (86.46) | 3.118 | (79.20) | 2.972 | (75.49) | 2.652 | (67.36) |
| 20 | 40 | 4.026 | (102.26) | 3.716 | (94.39) | 3.430 | (87.12) | 3.284 | (83.41) | 2.964 | (75.29) |
| 22 | 44 | 4.338 | (110.19) | 4.028 | (102.31) | 3.742 | (95.05) | 3.596 | (91.34) | 3.276 | (83.21) |
| 25 | 50 | 4.806 | (122.07) | 4.496 | (114.20) | 4.210 | (106.93) | 4.064 | (103.23) | 3.744 | (95.10) |
| 28 | 56 | 5.274 | (133.96) | 4.964 | (126.09) | 4.678 | (118.82) | 4.532 | (115.11) | 4.212 | (106.98) |
| 30 | 60 | 5.586 | (141.88) | 5.276 | (134.01) | 4.990 | (126.75) | 4.844 | (123.04) | 4.524 | (114.91) |
| 36 | 72 | 6.522 | (165.66) | 6.212 | (157.78) | 5.926 | (150.52) | 5.780 | (146.81) | 5.460 | (138.68) |
| 43 | 86 | 7.614 | (193.40) | 7.304 | (185.52) | 7.018 | (178.26) | 6.872 | (174.55) | 6.552 | (166.42) |
| 44 | 88 | 7.770 | (197.36) | 7.460 | (189.48) | 7.174 | (182.22) | 7.028 | (178.51) | 6.708 | (170.38) |

Dimensions of Other Connector Sizes are Listed

337/387 SERIES CARD EDGE CONNECTOR

.156" (3.96mm) Contact Spacing

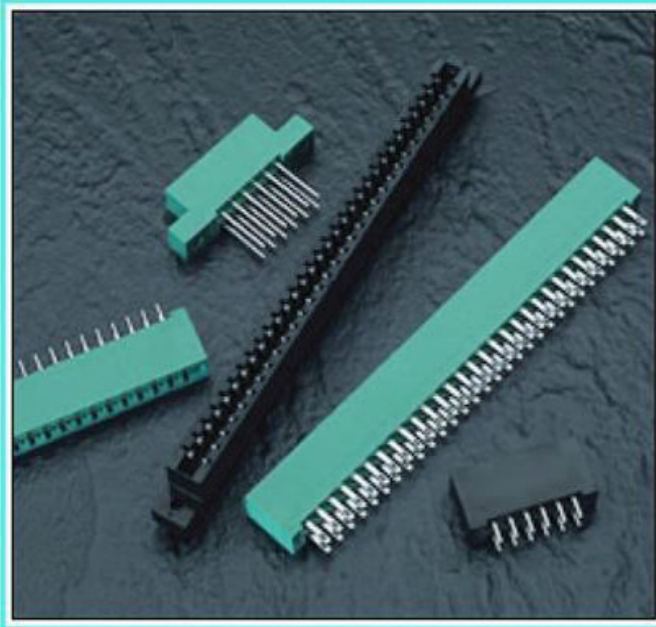

FEATURES

- CSA Approved and UL Recognized
- .156 (3.96) Contact Spacing x .200 (5.08) Row Spacing
- Accepts .062 (1.57) Nominal Thickness P.C. Board
- High Profile Insulator Body, .600 (15.24)
- Contact Termination Options include P.C. Tail, Wire Hole, Wire Wrap, 90 Degree & Extender Board Bends
- Single or Dual Row Configurations
- Large Variety of Mounting Options, Flush or Offset Lugs
- Pre-assembled Card Guides Available
- Accepts Between Contact and In-Contact Polarizing Keys

SPECIFICATIONS

- ◆ Insulator Material: Thermoplastic Polyester, UL 94V-0
- ◆ Contact Material: Copper Alloy
- ◆ Contact Plating: Gold on the Mating Area, Tin on the Contact Tails, Nickel Underplate
- ◆ Current Rating: 3 Amperes Continuous
- ◆ Contact Resistance: 10 Milliohms Maximum
- ◆ Dielectric Withstanding Voltage: 1800 V AC rms at Sea Level Between Adjacent Contacts
- ◆ Insulation Resistance: 5000 Megohms Minimum
- ◆ Operating Temperature: -65 to +105 Degrees C
- ◆ Insertion Force: 16 oz (4.45 N) Maximum per Contact Pair when Tested with a .070 (1.78) Thick Gauge
- ◆ Withdrawal Force: 1 oz (0.28 N) Minimum per Contact Pair when Tested with a .054 (1.37) Thick Gauge

337/387 SERIES ORDERING CODE

Example Part Number **337 - 086 - 524 - 2 04**

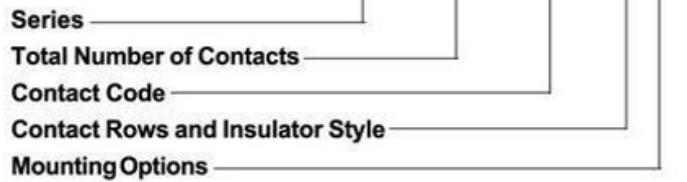

| Series | Insulator Colour |
|--------|------------------|
| 337 | Green |
| 387 | Black |

| Total Number of Contacts ¹ | Contact Rows |
|---------------------------------------|--------------|
| 006, 007,...043 | Single Row |
| 012, 014,...086 | Dual Row |

| Contact Code ^{2,3} | Description & Tail Size | Tail Length "G" |
|-----------------------------|---|-----------------|
| 500 | Wire Hole .050 x .025 (1.27 x 0.64) | .260 (6.60) |
| 520 | P.C. Tail .030 x .018 (0.76 x 0.46) | .175 (4.45) |
| 521 | P.C. Tail .025 Square (0.64 Square) | .150 (3.81) |
| 523 | P.C. Tail .025 Square (0.64 Square) | .390 (9.91) |
| 524 | P.C. Tail .018 Square (0.46 Square) | .175 (4.45) |
| 540 | Wire Wrap .025 Square (0.64 Square) | .560(14.22) |
| 541 | Wire Wrap .025 Square (0.64 Square) | .750(19.05) |
| 542 | Wire Wrap .025 Square (0.64 Square) | .645(16.38) |
| 544 | Wire Wrap .050 x .025 (1.27 x 0.64) | .750(19.05) |
| 555 | Extender Board Bend (Code 500 Contacts) | |
| 556 | Extender Board Bend (Code 520 Contacts) | |
| 558 | 90 Degree Bend (Code 541 Contacts) | |
| 559 | 90 Degree Bend (Code 541 Contacts) | |
| 560 | Extender Board Bend (Code 523 Contacts) | |

| Contact Rows and Insulator Style | Description |
|----------------------------------|-------------------------------------|
| 1 | Single Row, Flush Mounting Lugs |
| 2 | Dual Row, Flush Mounting Lugs |
| 6 | Single Row, .170 (4.32) Offset Lugs |
| 8 | Dual Row, .170 (4.32) Offset Lugs |

| Mounting Options ^{4,5,6} | Description |
|-----------------------------------|--------------------------------------|
| 01 | No Mounting Lugs |
| 02 | .128 (3.25) Dia. Mounting Holes |
| 03 | .116 (2.95) I.D. Floating Eyelets |
| 04 | .156 (3.96) Dia. Mounting Holes |
| 07 | M3-0.5 Metric Threaded Inserts |
| 08 | #4-40 Unified Threaded Inserts |
| 12 | .128 (3.25) Dia. Side Mounting Holes |
| 58 | .468 (11.89) Offset Card Guides |
| 68 | .344 (8.74) Offset Card Guides |
| 78 | In-Line Card Guides |

Ordering Code Notes

- 1) All connector sizes up to 43 contacts single row / 86 contacts dual row are available upon request.
- 2) The 500 contact code is standard in the 337 series only. Green polyphenylene sulphide insulator material will be supplied.
- 3) For details of the extender board and 90 degree bends, refer to page 61.
- 4) For lugless connectors, code 01 mounting, specify contact row codes 1 or 2.
- 5) In-line card guides are only available with offset mounting lugs.
- 6) For details of the mounting options, refer to page 63.

CARD EDGE CONNECTOR SERIES 337/387

Contact Spacing .156" (3.96mm)

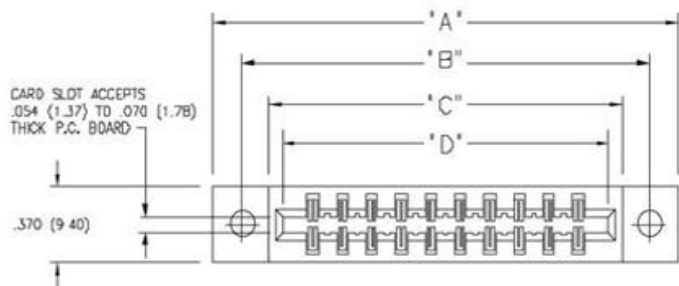

BETWEEN CONTACT
POLARIZING KEY

P/N 306-240-318

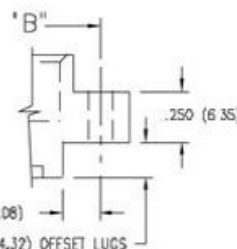
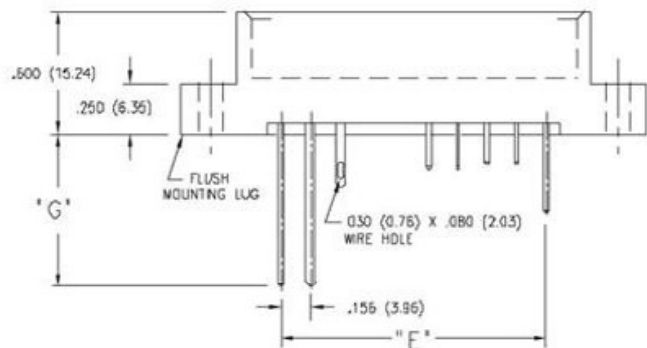

IN-CONTACT
POLARIZING KEY

P/N 345-240-328

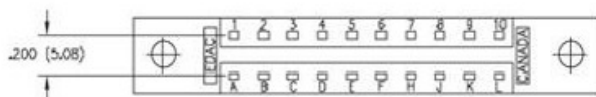

SINGLE ROW

DUAL ROW

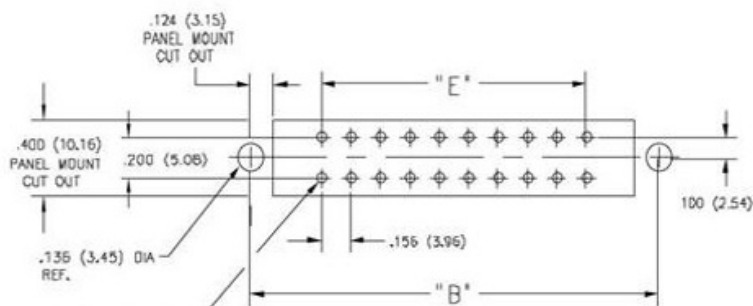
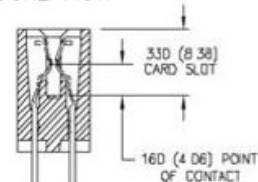
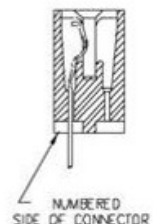

D42 (1.07) + .004 (0.10) / - .000
FOR ALL P.C. TAILS
EXCEPT CODE 524

.031 (0.79) + .004 (0.10) / - .000
FOR CODE 524 P.C. TAIL

⌀ .008 (0.20) DIA

CONNECTOR MOUNTING PATTERN

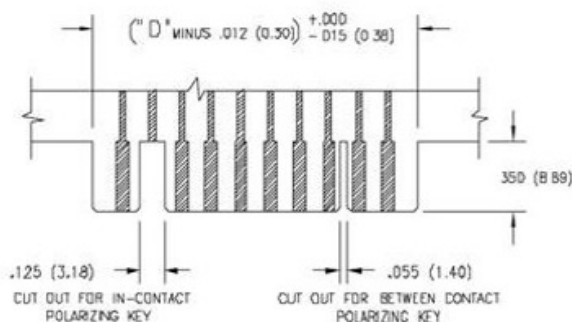

CUT OUT FOR IN-CONTACT
POLARIZING KEY

CUT OUT FOR BETWEEN CONTACT
POLARIZING KEY

RECOMMENDED DAUGHTER BOARD

| NUMBER OF CONTACTS | | "A" | | "B" | | "C" | | "D" | | "E" | |
|--------------------|------|-------|----------|-------|----------|-------|----------|-------|----------|-------|----------|
| Single | Dual | Inch | (mm) | Inch | (mm) | Inch | (mm) | Inch | (mm) | Inch | (mm) |
| 6 | 12 | 1.842 | (46.79) | 1.532 | (38.91) | 1.246 | (31.65) | 1.100 | (27.94) | .780 | (19.81) |
| 10 | 20 | 2.466 | (62.64) | 2.156 | (54.76) | 1.870 | (47.50) | 1.724 | (43.79) | 1.404 | (35.66) |
| 12 | 24 | 2.778 | (70.56) | 2.468 | (62.69) | 2.182 | (55.42) | 2.036 | (51.71) | 1.716 | (43.59) |
| 15 | 30 | 3.246 | (82.45) | 2.936 | (74.57) | 2.650 | (67.31) | 2.504 | (63.60) | 2.184 | (55.47) |
| 18 | 36 | 3.714 | (94.34) | 3.404 | (86.46) | 3.118 | (79.20) | 2.972 | (75.49) | 2.652 | (67.36) |
| 22 | 44 | 4.338 | (110.19) | 4.028 | (102.31) | 3.742 | (95.05) | 3.596 | (91.34) | 3.276 | (83.21) |
| 25 | 50 | 4.806 | (122.07) | 4.496 | (114.20) | 4.210 | (106.93) | 4.064 | (103.23) | 3.744 | (95.10) |
| 26 | 52 | 4.962 | (126.03) | 4.652 | (118.16) | 4.366 | (110.90) | 4.220 | (107.19) | 3.900 | (99.06) |
| 28 | 56 | 5.274 | (133.96) | 4.964 | (126.09) | 4.678 | (118.82) | 4.532 | (115.11) | 4.212 | (106.98) |
| 31 | 62 | 5.742 | (145.85) | 5.432 | (137.97) | 5.146 | (130.71) | 5.000 | (127.00) | 4.680 | (118.87) |
| 33 | 66 | 6.054 | (153.77) | 5.744 | (145.90) | 5.458 | (138.63) | 5.312 | (134.92) | 4.992 | (126.80) |
| 36 | 72 | 6.522 | (165.66) | 6.212 | (157.78) | 5.926 | (150.52) | 5.780 | (146.81) | 5.460 | (138.68) |
| 43 | 86 | 7.614 | (193.40) | 7.304 | (185.52) | 7.018 | (178.26) | 6.872 | (174.55) | 6.552 | (166.42) |

Dimensions of Other Connector Sizes are Listed

303 SERIES CARD EDGE CONNECTOR

.156" (3.96mm) Contact Spacing

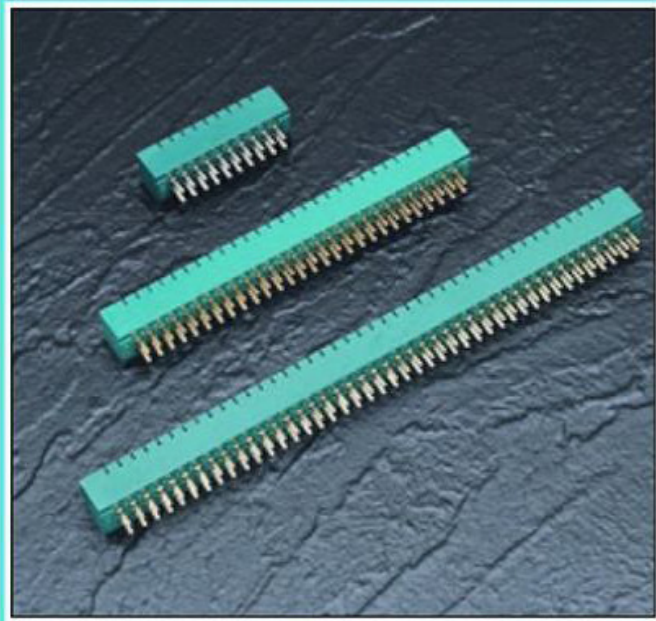

FEATURES

- UL Recognized
- .156 (3.96) Contact Spacing x .140 (3.56) Row Spacing
- Accepts .062 (1.57) Nominal Thickness P.C. Board
- Low Profile Insulator Body, .470 (11.94)
- Contact Termination P.C. Tail
- Variety of Mounting Options
- Accepts Between Contact and In-Contact Polarizing Keys

SPECIFICATIONS

- ◆ Insulator Material: Thermoplastic Polyester, UL 94V-O, Colour: Green
- ◆ Contact Material: Copper Alloy
- ◆ Contact Plating: Gold on the Mating Area, Tin on the Contact Tails, Nickel Underplate
- ◆ Current Rating: 5 Amperes Continuous
- ◆ Contact Resistance: 10 Milliohms Maximum
- ◆ Dielectric Withstanding Voltage: 1800 V AC rms at Sea Level Between Adjacent Contacts
- ◆ Insulation Resistance: 5000 Megohms Minimum
- ◆ Operating Temperature: -65 to +105 Degrees C
- ◆ Insertion Force: 16 oz (4.45 N) Maximum per Contact Pair when Tested with a .070 (1.78) Thick Gauge
- ◆ Withdrawal Force: 1 oz (0.28 N) Minimum per Contact Pair when Tested with a .054 (1.37) Thick Gauge

303 SERIES ORDERING CODE

Example Part Number **303 - 086 - 520 - 202**

Series _____
 Total Number of Contacts _____
 Contact Code _____
 Mounting Options _____

Series 303

| | |
|--|---------------------|
| Total Number of Contacts ¹ | Contact Rows |
| 012, 014,...086 | Dual Row |

| Contact Code | Description & Tail Size | Tail Length "G" |
|--------------|-------------------------------------|-----------------|
| 520 | P.C. Tail .046 x .010 (1.17 x 0.25) | .219 (5.56) |

| Mounting Options ² | Description |
|-------------------------------|-----------------------------------|
| 201 | No Mounting Lugs |
| 202 | .128 (3.25) Dia. Mounting Holes |
| 203 | .116 (2.95) I.D. Floating Eyelets |
| 204 | .156 (3.96) Dia. Mounting Holes |
| 207 | M3-0.5 Metric Threaded Inserts |
| 208 | #4-40 Unified Threaded Inserts |

Ordering Code Notes

- 1) All connector sizes up to 86 contacts dual row are available upon request.
- 2) For details of the mounting options, refer to page 63.

CARD EDGE CONNECTOR SERIES 303

Contact Spacing .156" (3.96mm)

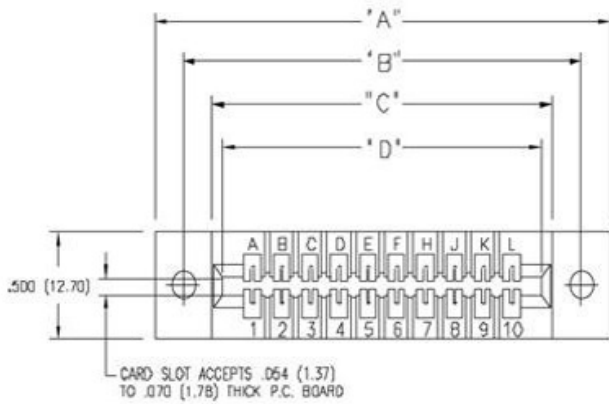

IN-CONTACT
POLARIZING KEY

P/N 307-240-328

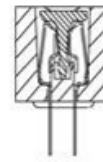

BETWEEN CONTACT
POLARIZING KEY

P/N 306-240-318

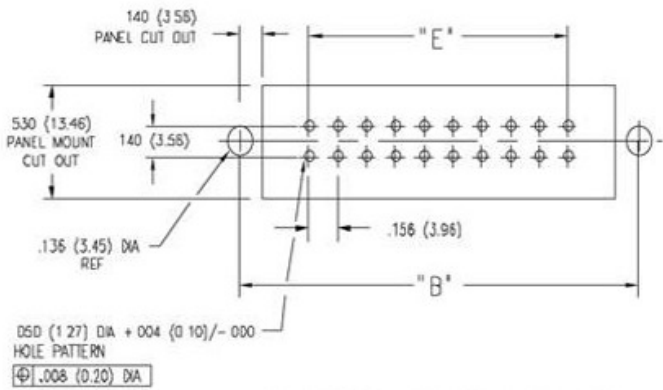
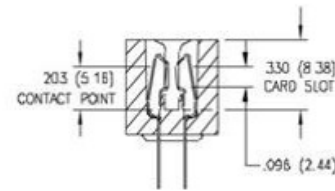
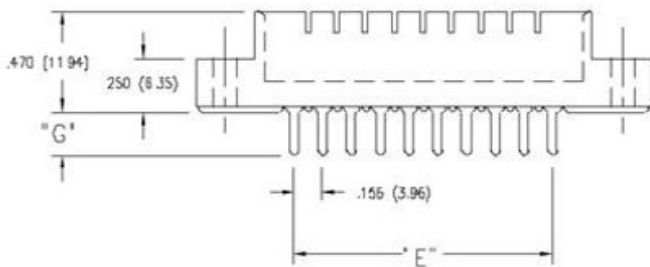

CONNECTOR MOUNTING PATTERN

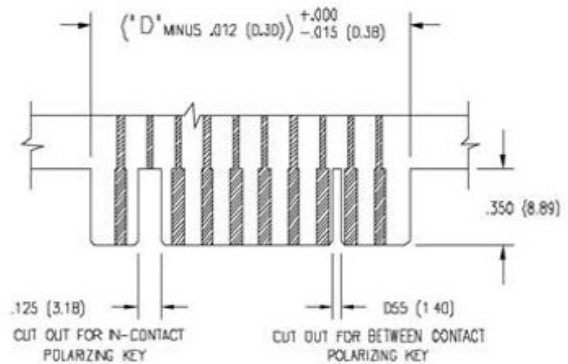

RECOMMENDED DAUGHTER BOARD

| NUMBER OF CONTACTS | "A" | | "B" | | "C" | | "D" | | "E" | |
|--------------------|-------|----------|-------|----------|-------|----------|-------|----------|-------|----------|
| | Inch | (mm) | Inch | (mm) | Inch | (mm) | Inch | (mm) | Inch | (mm) |
| Dual | | | | | | | | | | |
| 12 | 1.842 | (46.79) | 1.532 | (38.91) | 1.220 | (30.99) | 1.100 | (27.94) | .780 | (19.81) |
| 20 | 2.466 | (62.64) | 2.156 | (54.76) | 1.844 | (46.84) | 1.724 | (43.79) | 1.404 | (35.66) |
| 30 | 3.246 | (82.45) | 2.936 | (74.57) | 2.624 | (66.65) | 2.504 | (63.60) | 2.184 | (55.47) |
| 36 | 3.714 | (94.34) | 3.404 | (86.46) | 3.092 | (78.54) | 2.972 | (75.49) | 2.652 | (67.36) |
| 44 | 4.338 | (110.19) | 4.028 | (102.31) | 3.716 | (94.39) | 3.596 | (91.34) | 3.276 | (83.21) |
| 48 | 4.650 | (118.11) | 4.340 | (110.24) | 4.028 | (102.31) | 3.908 | (99.26) | 3.588 | (91.14) |
| 56 | 5.274 | (133.96) | 4.964 | (126.09) | 4.652 | (118.16) | 4.532 | (115.11) | 4.212 | (106.98) |
| 72 | 6.522 | (165.66) | 6.212 | (157.78) | 5.900 | (149.86) | 5.780 | (146.81) | 5.460 | (138.68) |
| 86 | 7.614 | (193.40) | 7.304 | (185.52) | 6.992 | (177.60) | 6.872 | (174.55) | 6.552 | (166.42) |

Dimensions of Other Connector Sizes are Listed

317 SERIES CARD EDGE CONNECTOR

.156" (3.96mm) Contact Spacing

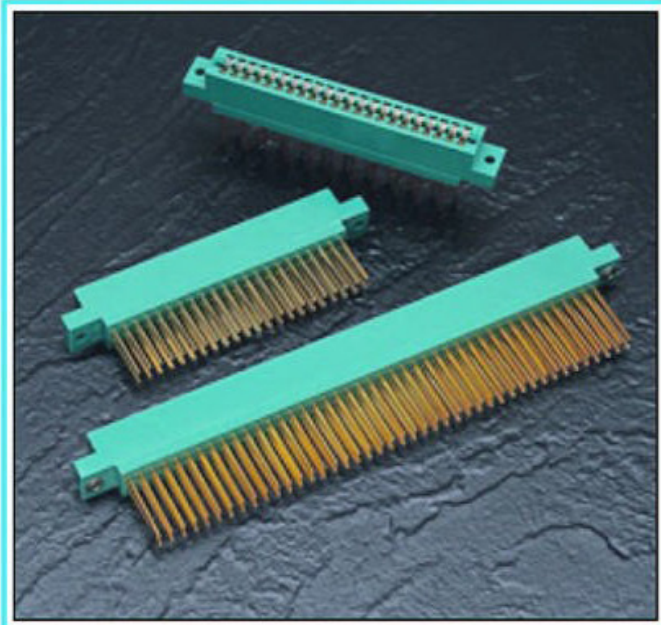

FEATURES

- .156 (3.96) Contact Spacing x .200 (5.08) Row Spacing
- Accepts .062 (1.57) Nominal Thickness P.C. Board
- High Profile Insulator Body, .720 (18.29)
- Contact Termination .045 (1.14) Square Wire Wrap
- Single or Dual Row Configurations
- Large Variety of Mounting Options
- Pre-assembled Card Guides Available
- Accepts Between Contact and In-Contact Polarizing Keys

SPECIFICATIONS

- ◆ Insulator Material: Polyphenylene Sulphide, UL 94V-0, Colour: Green
- ◆ Contact Material: Copper Alloy
- ◆ Contact Plating: Gold on the Mating Area, Tin on the Contact Tails, Nickel Underplate
- ◆ Current Rating: 5 Amperes Continuous
- ◆ Contact Resistance: 10 Milliohms Maximum
- ◆ Dielectric Withstanding Voltage: 1800 V AC rms at Sea Level Between Adjacent Contacts
- ◆ Insulation Resistance: 5000 Megohms Minimum
- ◆ Operating Temperature: -65 to +125 Degrees C
- ◆ Insertion Force: 16 oz (4.45 N) Maximum per Contact Pair when Tested with a .070 (1.78) Thick Gauge
- ◆ Withdrawal Force: 1 oz (0.28 N) Minimum per Contact Pair when Tested with a .054 (1.37) Thick Gauge

317 SERIES ORDERING CODE

Example Part Number **317 - 072 - 542 - 8 08**

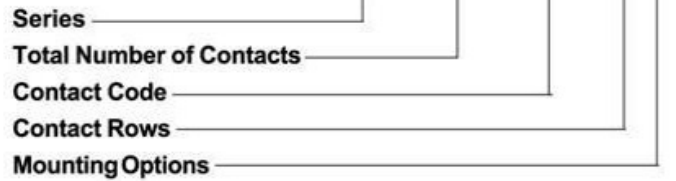

Series 317

| Total Number of Contacts ¹ | Description |
|---------------------------------------|-------------|
| 006, 007,...043 | Single Row |
| 012, 014,...086 | Dual Row |

| Contact Code | Description & Tail Size | Tail Length "G" |
|--|-------------------------------------|-----------------|
| <i>Single Row Contact - Read One Side of Daughter Board</i> | | |
| 542 | Wire Wrap .045 Square (1.14 Square) | .750 (19.05) |
| <i>Single Row Contacts - Read Both Sides of Daughter Board</i> | | |
| 541 | Wire Wrap .045 Square (1.14 Square) | .750 (19.05) |
| <i>Dual Row Contacts</i> | | |
| 540 | Wire Wrap .045 Square (1.14 Square) | .750 (19.05) |
| 542 | Wire Wrap .045 Square (1.14 Square) | .750 (19.05) |

| Contact Rows | Description |
|--------------|-------------|
| 6 | Single Row |
| 8 | Dual Row |

| Mounting Options ² | Description |
|-------------------------------|-----------------------------------|
| 01 | No Mounting Lugs |
| 02 | .144 (3.66) Dia. Mounting Holes |
| 03 | .116 (2.95) I.D. Floating Eyelets |
| 04 | .156 (3.96) Dia. Mounting Holes |
| 07 | M3-0.5 Metric Threaded Inserts |
| 08 | #4-40 Unified Threaded Inserts |
| 78 | In-Line Card Guides |

Ordering Code Notes

- 1) All connector sizes up to 43 contacts single row / 86 contacts dual row are available upon request.
- 2) For details of the mounting options, refer to page 63.

IN-CONTACT
POLARIZING KEY

P/N 321-240-328

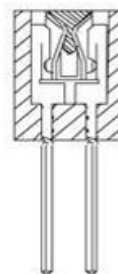

BETWEEN CONTACT
POLARIZING KEY

P/N 306-240-318

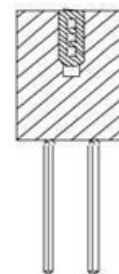

CARD EDGE CONNECTOR SERIES 317

Contact Spacing .156" (3.96mm)

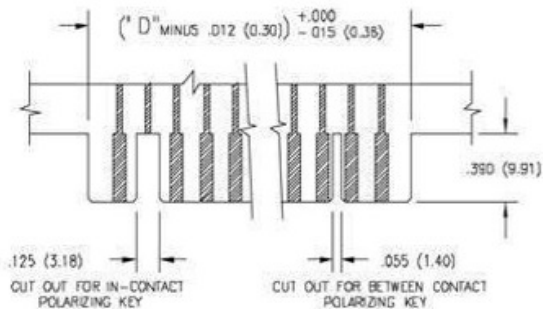
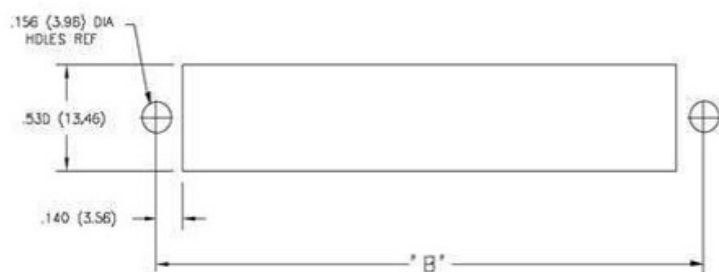
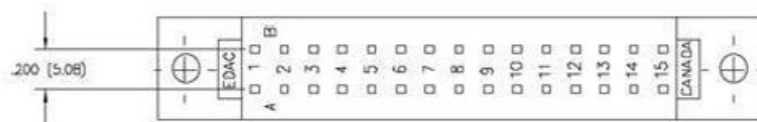
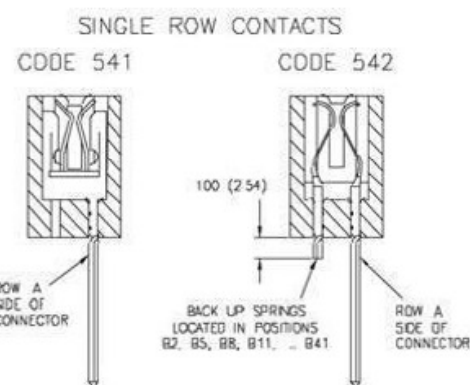
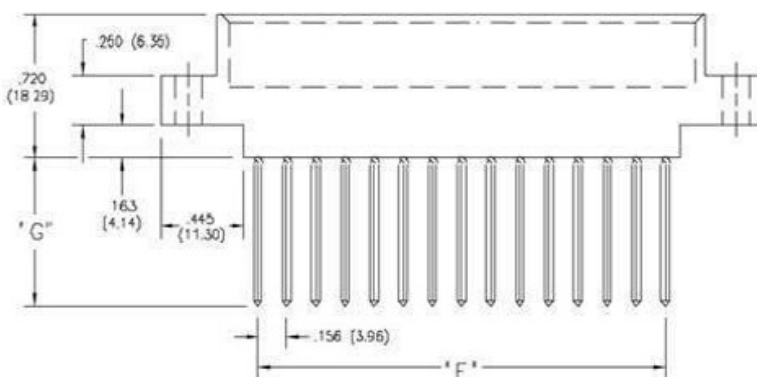
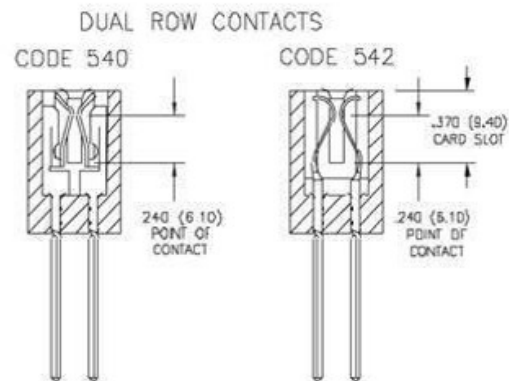
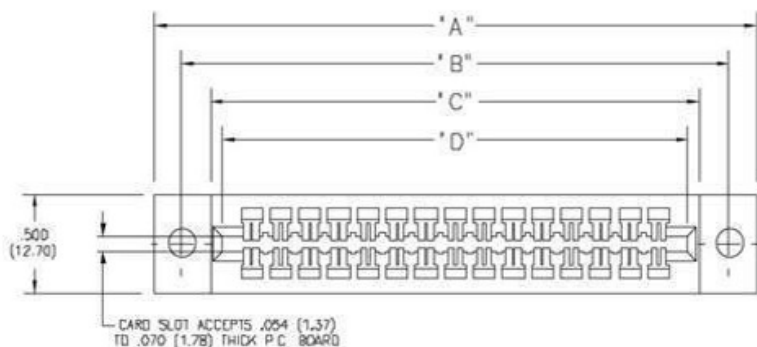

CONNECTOR MOUNTING PATTERN
PANEL MOUNT CUT OUT

RECOMMENDED DAUGHTER BOARD

| NUMBER OF CONTACTS | | "A" | | "B" | | "C" | | "D" | | "E" | |
|--------------------|------|-------|----------|-------|----------|-------|----------|-------|----------|-------|----------|
| Single | Dual | Inch | (mm) | Inch | (mm) | Inch | (mm) | Inch | (mm) | Inch | (mm) |
| 6 | 12 | 1.830 | (46.48) | 1.539 | (39.09) | 1.220 | (30.99) | 1.100 | (27.94) | .780 | (19.81) |
| 10 | 20 | 2.454 | (62.33) | 2.163 | (54.94) | 1.844 | (46.84) | 1.724 | (43.79) | 1.404 | (35.66) |
| 15 | 30 | 3.234 | (82.14) | 2.943 | (74.75) | 2.624 | (66.65) | 2.504 | (63.60) | 2.184 | (55.47) |
| 18 | 36 | 3.702 | (94.03) | 3.411 | (86.64) | 3.092 | (78.54) | 2.972 | (75.49) | 2.652 | (67.36) |
| 22 | 44 | 4.326 | (109.88) | 4.035 | (102.49) | 3.716 | (94.39) | 3.596 | (91.34) | 3.276 | (83.21) |
| 25 | 50 | 4.794 | (121.77) | 4.503 | (114.38) | 4.184 | (106.27) | 4.064 | (103.23) | 3.744 | (95.10) |
| 28 | 56 | 5.262 | (133.65) | 4.971 | (126.26) | 4.652 | (118.16) | 4.532 | (115.11) | 4.212 | (106.98) |
| 30 | 60 | 5.574 | (141.58) | 5.283 | (134.19) | 4.964 | (126.09) | 4.844 | (123.04) | 4.524 | (114.91) |
| 36 | 72 | 6.510 | (165.35) | 6.219 | (157.96) | 5.900 | (149.86) | 5.780 | (146.81) | 5.460 | (138.68) |
| 43 | 86 | 7.602 | (193.09) | 7.311 | (185.70) | 6.992 | (177.60) | 6.872 | (174.55) | 6.552 | (166.42) |

Dimensions of Other Connector Sizes are Listed

333 SERIES CARD EDGE CONNECTOR

.156" (3.96mm) Contact Spacing

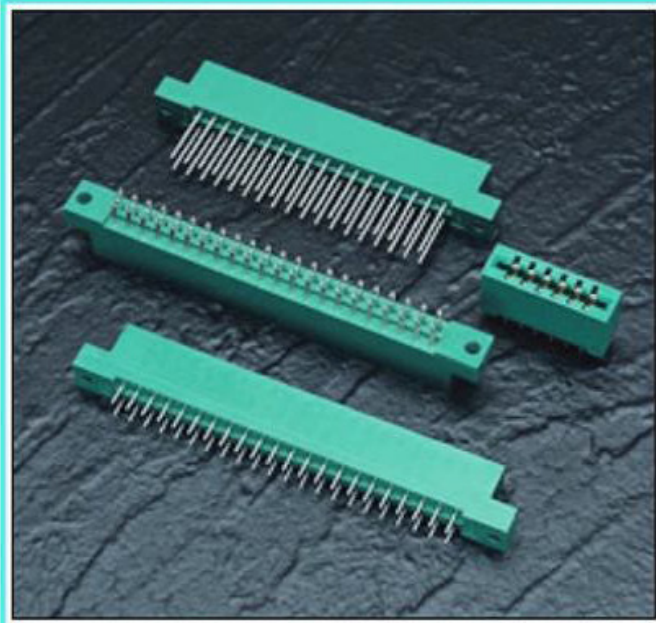

FEATURES

- .156 (3.96) Contact Spacing x .200 (5.08) Row Spacing
- Accepts .062 (1.57) Nominal Thickness P.C. Board
- High Profile Insulator Body, .600 (15.24)
- Contact Termination Options include P.C. Tail, Wire Hole, Wire Wrap, 90 Degree & Extender Board Bends
- Single or Dual Row Configurations
- Variety of Mounting Options, Flush or Offset Lugs
- Accepts Between Contact and In-Contact Polarizing Keys

SPECIFICATIONS

- ◆ Insulator Material: Thermoplastic Polyester, UL 94V-0, Colour: Green
- ◆ Contact Material: Copper Alloy
- ◆ Contact Plating: Gold on the Mating Area, Tin on the Contact Tails, Nickel Underplate
- ◆ Current Rating: 3 Amperes Continuous
- ◆ Contact Resistance: 10 Milliohms Maximum
- ◆ Dielectric Withstanding Voltage: 1800 V AC rms at Sea Level Between Adjacent Contacts
- ◆ Insulation Resistance: 5000 Megohms Minimum
- ◆ Operating Temperature: -65 to +105 Degrees C
- ◆ Insertion Force: 16 oz (4.45 N) Maximum per Contact Pair when Tested with a .070 (1.78) Thick Gauge
- ◆ Withdrawal Force: 1 oz (0.28 N) Minimum per Contact Pair when Tested with a .054 (1.37) Thick Gauge

333 SERIES ORDERING CODE

Example Part Number **333 - 044 - 520 - 2 04**

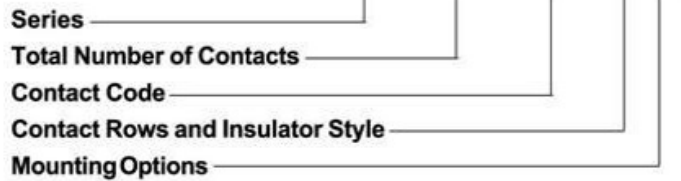

Series 333

| Total Number of Contacts ¹ | Description |
|---------------------------------------|-------------|
| 006, 007,...043 | Single Row |
| 012, 014,...086 | Dual Row |

| Contact Code ^{2,3} | Description & Tail Size | Tail Length "G" |
|-----------------------------|---|-----------------|
| 500 | Wire Hole .050 x .025 (1.27 x 0.64) | .260 (6.60) |
| 520 | P.C. Tail .030 x .018 (0.76 x 0.46) | .175 (4.45) |
| 521 | P.C. Tail .025 Square (0.64 Square) | .150 (3.81) |
| 523 | P.C. Tail .025 Square (0.64 Square) | .390 (9.91) |
| 524 | P.C. Tail .018 Square (0.46 Square) | .175 (4.45) |
| 540 | Wire Wrap .025 Square (0.64 Square) | .560(14.22) |
| 541 | Wire Wrap .025 Square (0.64 Square) | .750(19.05) |
| 542 | Wire Wrap .025 Square (0.64 Square) | .645(16.38) |
| 544 | Wire Wrap .050 x .025 (1.27 x 0.64) | .750(19.05) |
| 555 | Extender Board Bend (Code 500 Contacts) | |
| 556 | Extender Board Bend (Code 520 Contacts) | |
| 558 | 90 Degree Bend (Code 541 Contacts) | |
| 559 | 90 Degree Bend (Code 541 Contacts) | |
| 560 | Extender Board Bend (Code 523 Contacts) | |

| Contact Rows and Insulator Style | Description |
|----------------------------------|-------------------------------------|
| 1 | Single Row, Flush Mounting Lugs |
| 2 | Dual Row, Flush Mounting Lugs |
| 6 | Single Row, .170 (4.32) Offset Lugs |
| 8 | Dual Row, .170 (4.32) Offset Lugs |

| Mounting Options ^{4,5} | Description |
|---------------------------------|--------------------------------------|
| 01 | No Mounting Lugs |
| 02 | .128 (3.25) Dia. Mounting Holes |
| 03 | .116 (2.95) I.D. Floating Eyelets |
| 04 | .156 (3.96) Dia. Mounting Holes |
| 07 | M3-0.5 Metric Threaded Inserts |
| 08 | #4-40 Unified Threaded Inserts |
| 12 | .128 (3.25) Dia. Side Mounting Holes |

Ordering Code Notes

- 1) All connector sizes up to 43 contacts single row / 86 contacts dual row are available upon request.
- 2) When the 500 contact code is ordered, green polyphenylene sulphide insulator material will be supplied.
- 3) For details of the extender board and 90 degree bends, refer to page 61.
- 4) For lugless connectors, code 01 mounting, specify contact row codes 1 or 2.
- 5) For details of the mounting options, refer to page 63.

CARD EDGE CONNECTOR SERIES 333

Contact Spacing .156" (3.96mm)

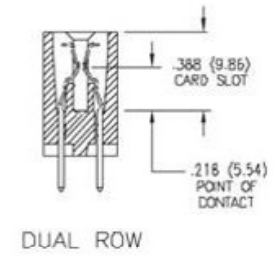
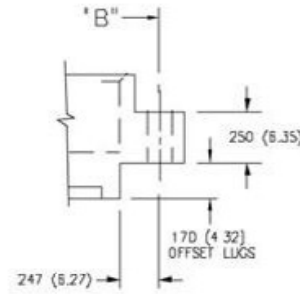
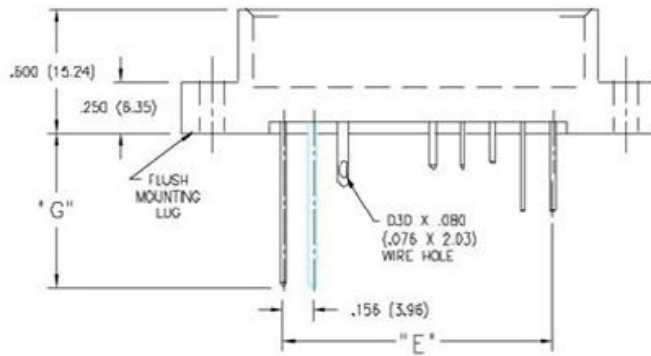
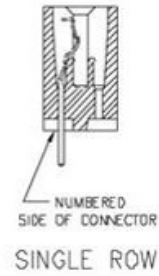
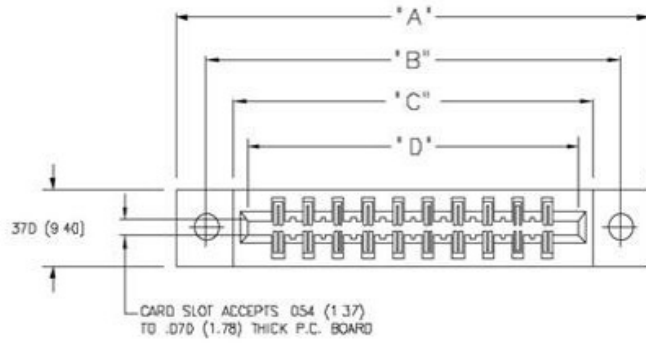

IN-CONTACT
POLARIZING KEY
P/N 345-240-328

BETWEEN CONTACT
POLARIZING KEY
P/N 306-240-318

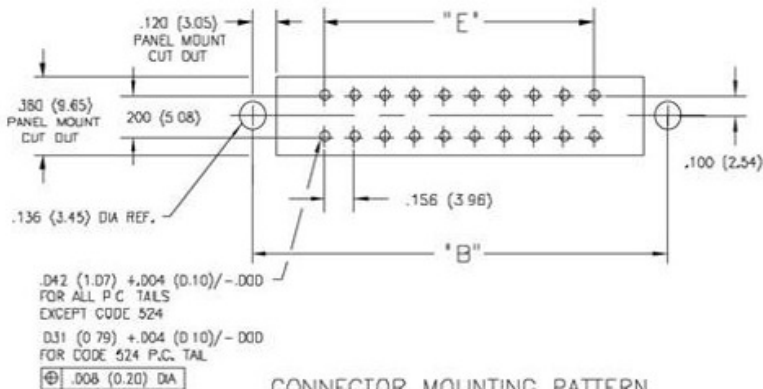
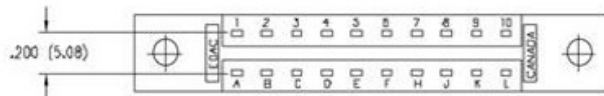

CONNECTOR MOUNTING PATTERN

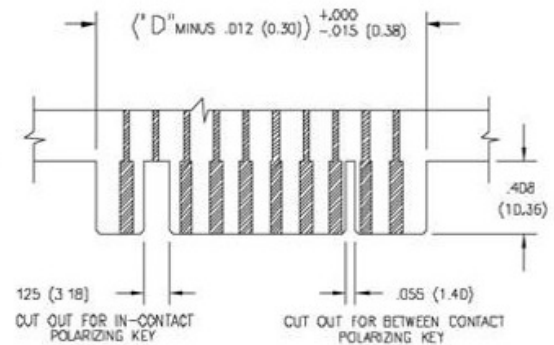

RECOMMENDED DAUGHTER BOARD

| NUMBER OF CONTACTS | | "A" | | "B" | | "C" | | "D" | | "E" | |
|--------------------|------|-------|----------|-------|----------|-------|----------|-------|----------|-------|----------|
| Single | Dual | Inch | (mm) | Inch | (mm) | Inch | (mm) | Inch | (mm) | Inch | (mm) |
| 6 | 12 | 1.784 | (45.31) | 1.534 | (38.96) | 1.261 | (32.03) | 1.100 | (27.94) | .780 | (19.81) |
| 10 | 20 | 2.408 | (61.16) | 2.158 | (54.81) | 1.885 | (47.88) | 1.724 | (43.79) | 1.404 | (35.66) |
| 15 | 30 | 3.188 | (80.98) | 2.938 | (74.63) | 2.665 | (67.69) | 2.504 | (63.60) | 2.184 | (55.47) |
| 18 | 36 | 3.656 | (92.86) | 3.406 | (86.51) | 3.133 | (79.58) | 2.972 | (75.49) | 2.652 | (67.36) |
| 22 | 44 | 4.280 | (108.71) | 4.030 | (102.36) | 3.757 | (95.43) | 3.596 | (91.34) | 3.276 | (83.21) |
| 28 | 56 | 5.216 | (132.49) | 4.966 | (126.14) | 4.693 | (119.20) | 4.532 | (115.11) | 4.212 | (106.98) |
| 36 | 72 | 6.464 | (164.19) | 6.214 | (157.84) | 5.941 | (150.90) | 5.780 | (146.81) | 5.460 | (138.68) |
| 37 | 74 | 6.620 | (168.15) | 6.370 | (161.80) | 6.097 | (154.86) | 5.936 | (150.77) | 5.616 | (142.65) |
| 43 | 86 | 7.556 | (191.92) | 7.306 | (185.57) | 7.033 | (178.64) | 6.872 | (174.55) | 6.552 | (166.42) |

Dimensions of Other Connector Sizes are Listed

336 SERIES CARD EDGE CONNECTOR

.156" (3.96mm) Contact Spacing

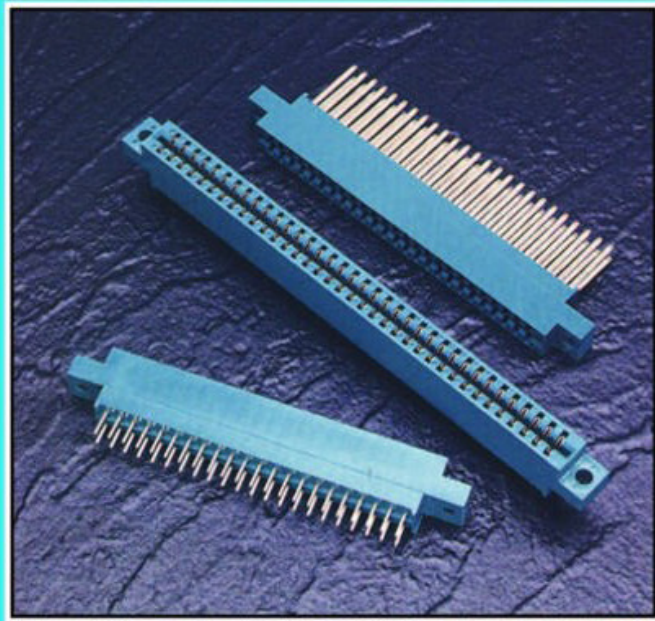

FEATURES

- .156 (3.96) Contact Spacing x .188 (4.78) Row Spacing
- Accepts .062 (1.57) Nominal Thickness P.C. Board
- High Profile Insulator Body, .720 (18.29)
- Contact Termination Options include P.C. Tail and .062 (1.57) x .031 (0.79) Wire Wrap
- Single or Dual Row Configurations
- Variety of Mounting Options
- Accepts Between Contact and In-Contact Polarizing Keys

SPECIFICATIONS

- ◆ Insulator Material: Polyphenylene Sulphide, UL 94V-O, Colour: Green
- ◆ Contact Material: Copper Alloy
- ◆ Contact Plating: Gold on the Mating Area, Tin on the Contact Tails, Nickel Underplate
- ◆ Current Rating: 5 Amperes Continuous
- ◆ Contact Resistance: 10 Milliohms Maximum
- ◆ Dielectric Withstanding Voltage: 1800 V AC rms at Sea Level Between Adjacent Contacts
- ◆ Insulation Resistance: 5000 Megohms Minimum
- ◆ Operating Temperature: -65 to +125 Degrees C
- ◆ Insertion Force: 16 oz (4.45 N) Maximum per Contact Pair when Tested with a .070 (1.78) Thick Gauge
- ◆ Withdrawal Force: 1 oz (0.28 N) Minimum per Contact Pair when Tested with a .054 (1.37) Thick Gauge

336 SERIES ORDERING CODE

Example Part Number **336 - 072 - 520 - 8 09**

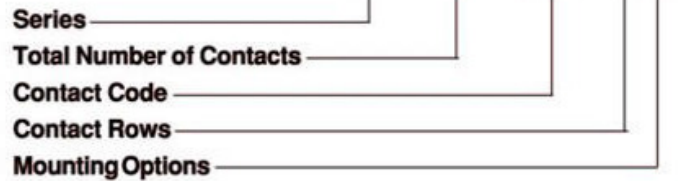

Series 336

| Total Number of Contacts ¹ | Contact Rows |
|---------------------------------------|--------------|
| 006, 007,...043 | Single Row |
| 012, 014,...086 | Dual Row |

| Contact Code | Description & Tail Size | Tail Length "G" |
|--------------|-------------------------------------|-----------------|
| 520 | P.C. Tail .031 Square (0.79 Square) | .260 (6.60) |
| 541 | Wire Wrap .062 x .031 (1.57 x 0.79) | .750(19.05) |

| Contact Rows | Description |
|--------------|-------------|
| 6 | Single Row |
| 8 | Dual Row |

| Mounting Options ² | Description |
|-------------------------------|-----------------------------------|
| 01 | No Mounting Lugs |
| 02 | .128 (3.25) Dia. Mounting Holes |
| 03 | .116 (2.95) I.D. Floating Eyelets |
| 04 | .156 (3.96) Dia. Mounting Holes |
| 07 | M3-0.5 Metric Threaded Inserts |
| 08 | #4-40 Unified Threaded Inserts |
| 09 | .178 (4.52) Dia. Mounting Holes |

Ordering Code Notes

- 1) All connector sizes up to 43 contacts single row / 86 contacts dual row are available upon request.
- 2) For details of the mounting options, refer to page 63.

CARD EDGE CONNECTOR SERIES 336

Contact Spacing .156" (3.96mm)

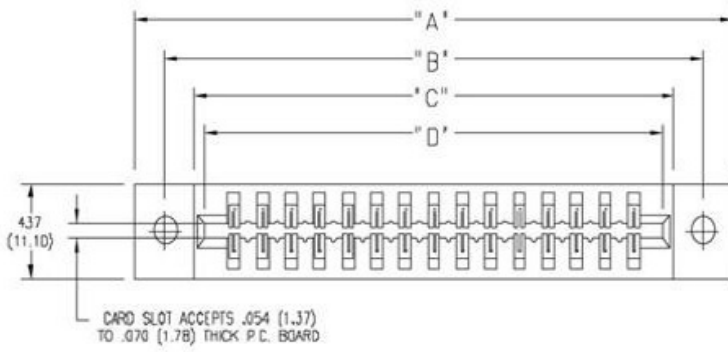

BETWEEN CONTACT
POLARIZING KEY

IN-CONTACT
POLARIZING KEY

P/N 336-240-318

P/N 345-240-328 (DUAL ROW)
P/N 335-240-328 (SINGLE ROW)

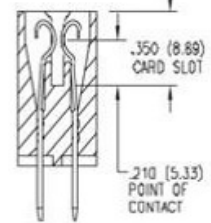
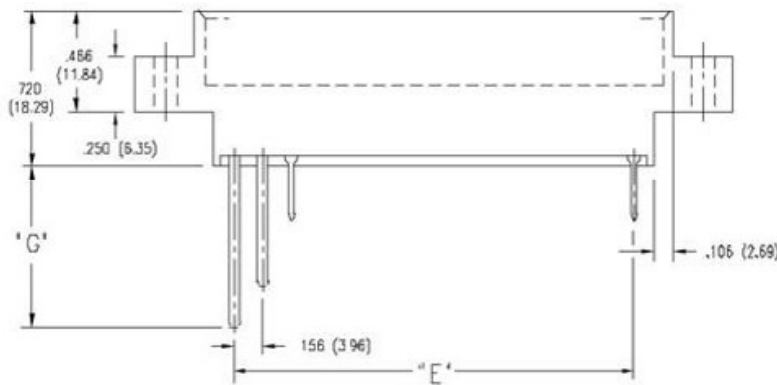
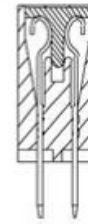

EVEN NUMBERED SIDE
OF CONNECTOR

SINGLE
ROW

DUAL
ROW

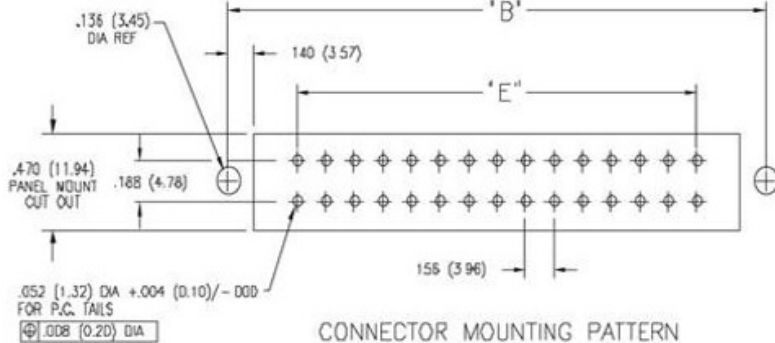

CONNECTOR MOUNTING PATTERN

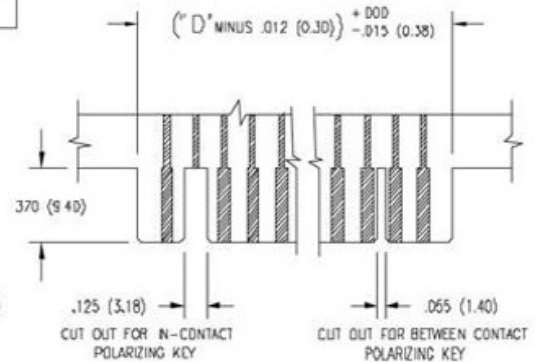

RECOMMENDED DAUGHTER BOARD

| NUMBER OF CONTACTS | | "A" | | "B" | | "C" | | "D" | | "E" | |
|--------------------|------|-------|----------|-------|----------|-------|----------|-------|----------|-------|----------|
| Single | Dual | Inch | (mm) | Inch | (mm) | Inch | (mm) | Inch | (mm) | Inch | (mm) |
| 6 | 12 | 1.857 | (47.17) | 1.534 | (38.96) | 1.216 | (30.89) | 1.100 | (27.94) | .780 | (19.81) |
| 10 | 20 | 2.481 | (63.02) | 2.158 | (54.81) | 1.840 | (46.74) | 1.724 | (43.79) | 1.404 | (35.66) |
| 15 | 30 | 3.261 | (82.83) | 2.938 | (74.63) | 2.620 | (66.55) | 2.504 | (63.60) | 2.184 | (55.47) |
| 18 | 36 | 3.729 | (94.72) | 3.406 | (86.51) | 3.088 | (78.44) | 2.972 | (75.49) | 2.652 | (67.36) |
| 22 | 44 | 4.353 | (110.57) | 4.030 | (102.36) | 3.712 | (94.28) | 3.596 | (91.34) | 3.276 | (83.21) |
| 25 | 50 | 4.821 | (122.45) | 4.498 | (114.25) | 4.180 | (106.17) | 4.064 | (103.23) | 3.744 | (95.10) |
| 28 | 56 | 5.289 | (134.34) | 4.966 | (126.14) | 4.648 | (118.06) | 4.532 | (115.11) | 4.212 | (106.98) |
| 36 | 72 | 6.537 | (166.04) | 6.214 | (157.84) | 5.896 | (149.76) | 5.780 | (146.81) | 5.460 | (138.68) |
| 43 | 86 | 7.629 | (193.78) | 7.306 | (185.57) | 6.988 | (177.50) | 6.872 | (174.55) | 6.552 | (166.42) |

Dimensions of Other Connector Sizes are Listed

338 SERIES CARD EDGE CONNECTOR

.156" (3.96mm) Contact Spacing

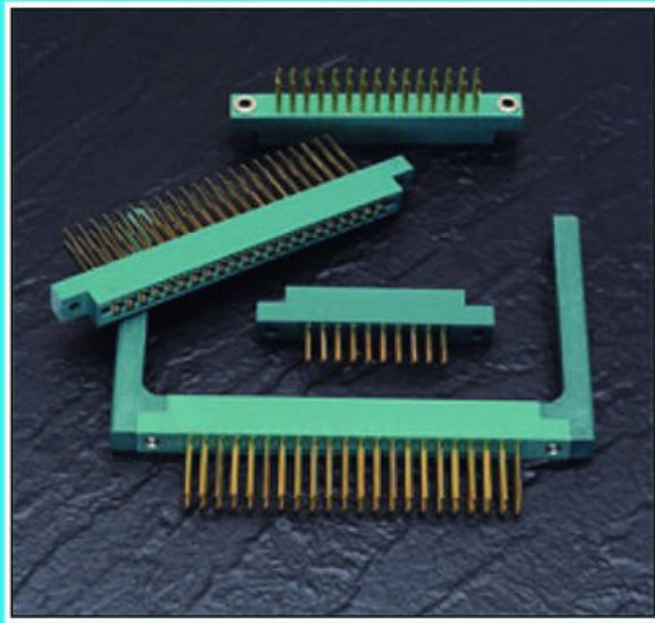

FEATURES

- .156 (3.96) Contact Spacing x .200 (5.08) Row Spacing
- Accepts .062 (1.57) Nominal Thickness P.C. Board
- Low Profile Insulator Body, .473 (12.01)
- Contact Termination .045 (1.14) Square Wire Wrap
- Single or Dual Row Configurations
- Large Variety of Mounting Options
- Pre-assembled Card Guides Available
- Accepts Between Contact and In-Contact Polarizing Keys

SPECIFICATIONS

- ◆ Insulator Material: Polyphenylene Sulphide, UL 94V-O, Colour: Green
- ◆ **Contact Material: Copper Alloy**
- ◆ Contact Plating: Gold over Nickel for Entire Contact
- ◆ Current Rating: 5 Amperes Continuous
- ◆ Contact Resistance: 10 Milliohms Maximum
- ◆ Dielectric Withstanding Voltage: 1800 V AC rms at Sea Level Between Adjacent Contacts
- ◆ Insulation Resistance: 5000 Megohms Minimum
- ◆ Operating Temperature: -65 to +125 Degrees C
- ◆ Insertion Force: 16 oz (4.45 N) Maximum per Contact Pair when Tested with a .070 (1.78) Thick Gauge
- ◆ Withdrawal Force: 1 oz (0.28 N) Minimum per Contact Pair when Tested with a .054 (1.37) Thick Gauge

338 SERIES ORDERING CODE

Example Part Number **338 - 044 - 541 - 2 08**

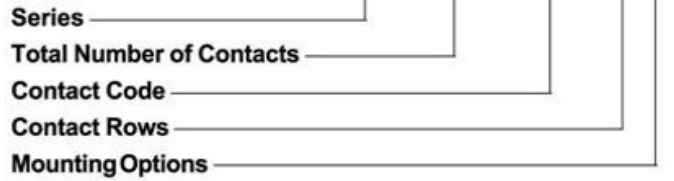

Series 338

| Total Number of Contacts | Contact Rows |
|---------------------------|--------------|
| 010, 015, 018, 022 or 028 | Single Row |
| 020, 030, 036, 044 or 056 | Dual Row |

| Contact Code | Description & Tail Size | Tail Length "G" |
|--------------|-------------------------------------|-----------------|
| 540 | Wire Wrap .045 Square (1.14 Square) | .480(12.19) |
| 541 | Wire Wrap .045 Square (1.14 Square) | .730(18.54) |

| Contact Rows | Description |
|--------------|-------------|
| 1 | Single Row |
| 2 | Dual Row |

| Mounting Options ¹ | Description |
|-------------------------------|-----------------------------------|
| 01 | No Mounting Lugs |
| 02 | .128 (3.25) Dia. Mounting Holes |
| 03 | .116 (2.95) I.D. Floating Eyelets |
| 04 | .156 (3.96) Dia. Mounting Holes |
| 07 | M3-0.5 Metric Threaded Inserts |
| 08 | #4-40 Unified Threaded Inserts |
| 58 | .468 (11.89) Offset Card Guides |
| 68 | .344 (8.74) Offset Card Guides |
| 78 | In-Line Card Guides |

Ordering Code Notes

1) For details of the mounting options, refer to page 63.

CARD EDGE CONNECTOR SERIES 338

Contact Spacing .156" (3.96mm)

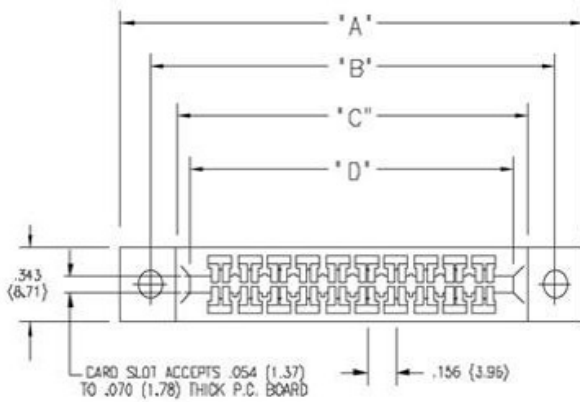

IN-CONTACT
POLARIZING KEY

P/N 338-240-328



BETWEEN CONTACT
POLARIZING KEY

P/N 306-240-318

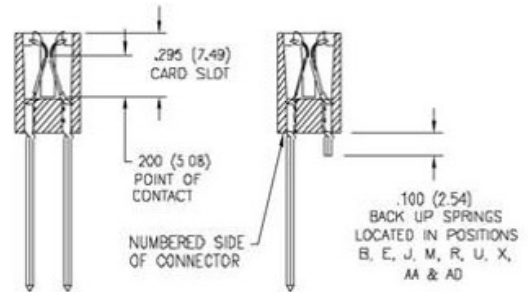
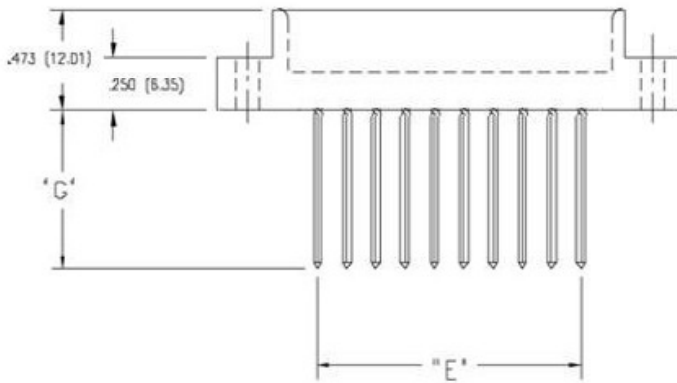

DUAL
ROW

SINGLE
ROW

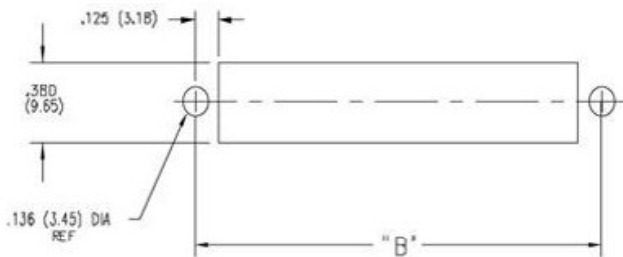
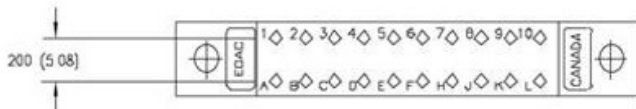

CONNECTOR MOUNTING PATTERN
PANEL MOUNT CUT OUT

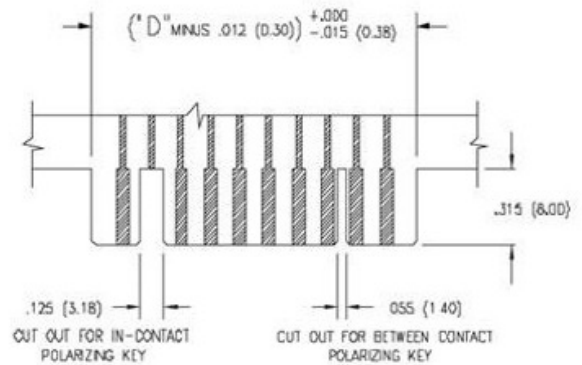

RECOMMENDED DAUGHTER BOARD

| NUMBER OF CONTACTS | | "A" | | "B" | | "C" | | "D" | | "E" | |
|--------------------|------|-------|----------|-------|----------|-------|----------|-------|----------|-------|----------|
| Single | Dual | Inch | (mm) | Inch | (mm) | Inch | (mm) | Inch | (mm) | Inch | (mm) |
| 10 | 20 | 2.466 | (62.64) | 2.156 | (54.76) | 1.870 | (47.50) | 1.724 | (43.79) | 1.404 | (35.66) |
| 15 | 30 | 3.246 | (82.45) | 2.936 | (74.57) | 2.650 | (67.31) | 2.504 | (63.60) | 2.184 | (55.47) |
| 18 | 36 | 3.714 | (94.34) | 3.404 | (86.46) | 3.118 | (79.20) | 2.972 | (75.49) | 2.652 | (67.36) |
| 22 | 44 | 4.338 | (110.19) | 4.028 | (102.31) | 3.742 | (95.05) | 3.596 | (91.34) | 3.276 | (83.21) |
| 28 | 56 | 5.274 | (133.96) | 4.964 | (126.09) | 4.678 | (118.82) | 4.532 | (115.11) | 4.212 | (106.98) |

310 SERIES CARD EDGE CONNECTOR

.156" (3.96mm) Contact Spacing

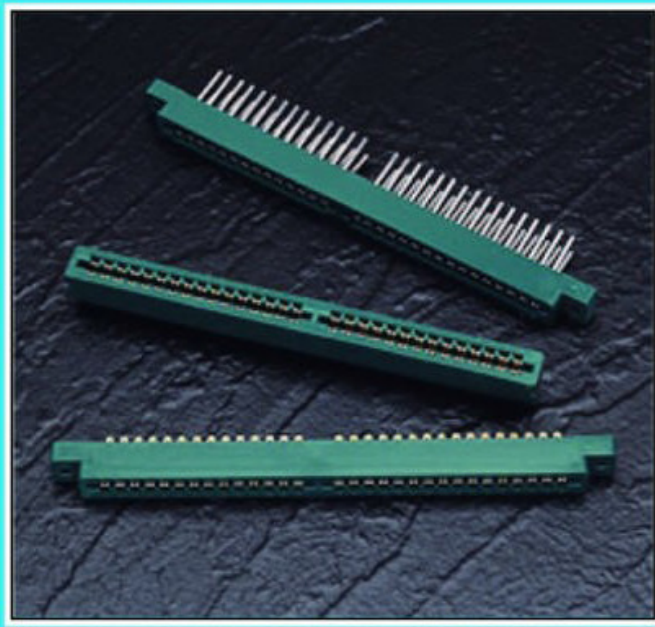

FEATURES

- .156 (3.96) Contact Spacing x .200 (5.08) Row Spacing
- Accepts .062 (1.57) Nominal Thickness P.C. Board
- Low Profile Insulator Body .460 (11.68), with Card Slot Barrier
- Contact Termination Options include P.C. Tail, Wire Hole, Wire Wrap & Extender Board Bends
- Single or Dual Row Configurations
- Variety of Mounting Options
- Accepts Between Contact and In-Contact Polarizing Keys

SPECIFICATIONS

- ◆ Insulator Material: Thermoplastic Polyester, UL 94V-0, Colour: Green
- ◆ Contact Material: Copper Alloy
- ◆ Contact Plating: Gold on the Mating Area, Tin on the Contact Tails, Nickel Underplate
- ◆ Current Rating: 5 Amperes Continuous
- ◆ For Additional Specifications, Refer to 307/357 Series.

310 SERIES ORDERING CODE

Example Part Number **310 - 060 - 520 - 2 02**

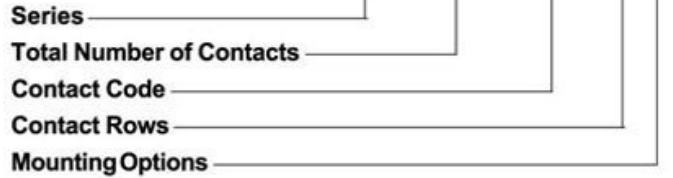

| | |
|--|---------------------|
| Series 310 | |
| Total Number of Contacts | Contact Rows |
| 030 | Single Row |
| 060 | Dual Row |
| Contact Code ¹ | |
| See 307/357 Series for Available Contact Options and "G" Dimension | |

| | |
|---------------------|--------------------|
| Contact Rows | Description |
| 1 | Single Row |
| 2 | Dual Row |

| | |
|--------------------------------------|-----------------------------------|
| Mounting Options ² | Description |
| 01 | No Mounting Lugs |
| 02 | .128 (3.25) Dia. Mounting Holes |
| 03 | .116 (2.95) I.D. Floating Eyelets |
| 04 | .156 (3.96) Dia. Mounting Holes |
| 07 | M3-0.5 Metric Threaded Inserts |
| 08 | #4-40 Unified Threaded Inserts |

Ordering Code Notes

- 1) 90 degree bends are not available on the 310 series.
- 2) For details of the mounting options, refer to page 63.

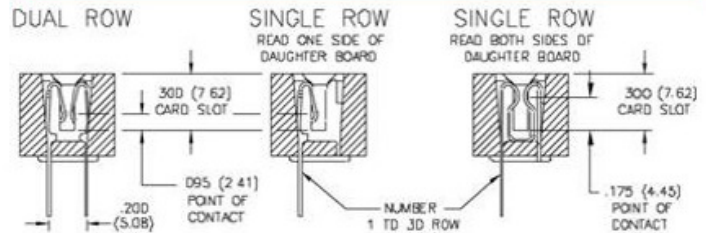
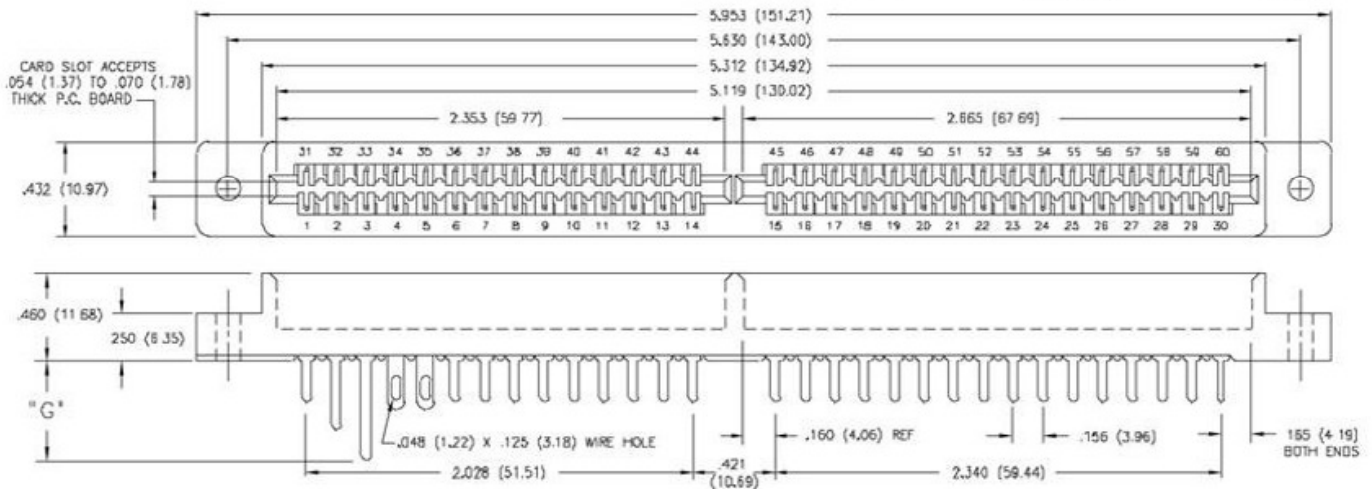

CARD EDGE CONNECTOR SERIES 321

Contact Spacing .156" (3.96mm)

321 SERIES ORDERING CODE

Example Part Number **321 - 030 - 542 - 8 02**

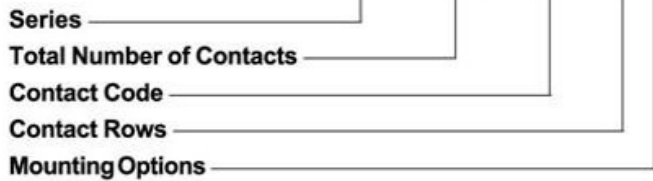

Series 321

| Total Number of Contacts | Contact Rows |
|--------------------------|--------------|
| 015 | Single Row |
| 030 | Dual Row |

Contact Code

See 317 Series for Available Contact Options and "G" Dimension

| Contact Rows | Description |
|--------------|-------------|
| 6 | Single Row |
| 8 | Dual Row |

Mounting Options¹

| Mounting Options ¹ | Description |
|-------------------------------|-----------------------------------|
| 01 | No Mounting Lugs |
| 02 | .128 (3.25) Dia. Mounting Holes |
| 03 | .116 (2.95) I.D. Floating Eyelets |
| 04 | .156 (3.96) Dia. Mounting Holes |
| 07 | M3-0.5 Metric Threaded Inserts |
| 08 | #4-40 Unified Threaded Inserts |

Ordering Code Notes

1) For details of the mounting options, refer to page 63.



FEATURES

- .156 (3.96) Contact Spacing x .200 (5.08) Row Spacing
- Accepts .062 (1.57) Nominal Thickness P.C. Board
- High Profile Insulator Body, .705 (17.91)
- Contact Termination .045 (1.14) Square Wire Wrap
- Single or Dual Row Configurations
- Variety of Mounting Options
- Accepts Between Contact and In-Contact Polarizing Keys

SPECIFICATIONS

- ◆ Insulator Material: Polyphenylene Sulphide, UL 94V-0, Colour: Green
- ◆ Contact Material: Copper Alloy
- ◆ Contact Plating: Gold over Nickel for Entire Contact
- ◆ Current Rating: 5 Amperes Continuous
- ◆ For Additional Specifications, Refer to 317 Series

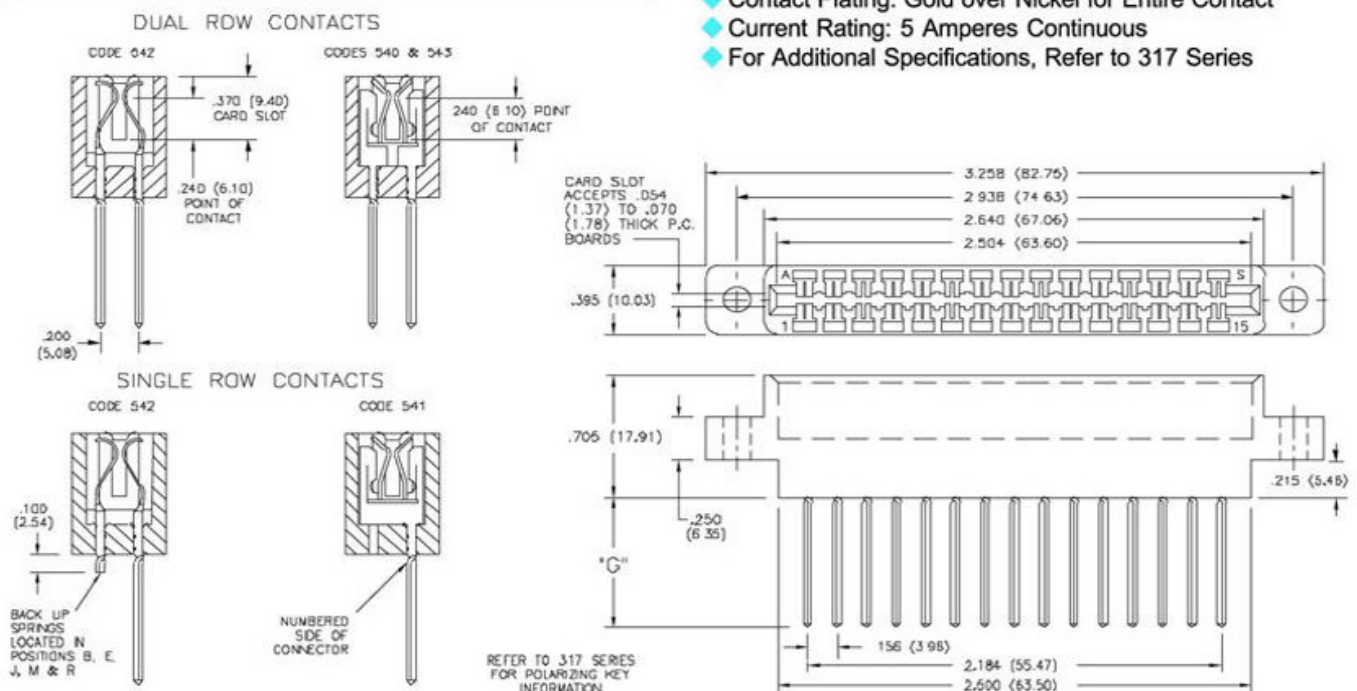

322 SERIES CARD EDGE CONNECTOR

.156" (3.96mm) Contact Spacing

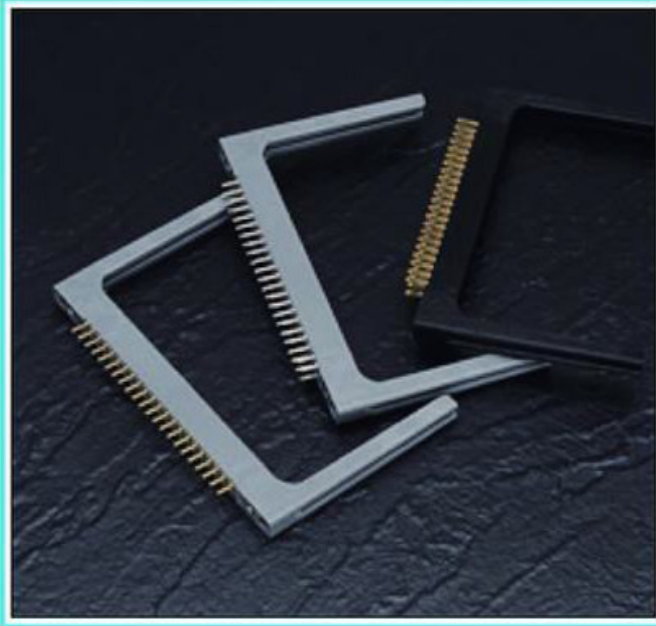

FEATURES

- .156 (3.96) Contact Spacing x .200 (5.08) Row Spacing
- Accepts .062 (1.57) Nominal Thickness P.C. Board
- Low Profile Insulator Body .473 (12.01), with Card Guides
- Contact Termination Options include P.C. Tail, Wire Hole, Wire Wrap, 90 Degree & Extender Board Bends
- Single or Dual Row Configurations
- Accepts Between Contact and In-Contact Polarizing Keys

SPECIFICATIONS

- ◆ Insulator Material: Polycarbonate , Glass Reinforced
- ◆ Contact Material: Copper Alloy

322 SERIES ORDERING CODE

Example Part Number **322 - 044 - 500 - 2 58**

Series _____
 Total Number of Contacts _____
 Contact Code _____
 Contact Rows and Insulator Material _____
 Mounting Options _____

Series 322

| Total Number of Contacts | Contact Rows |
|--------------------------|--------------|
| 022 | Single Row |
| 044 | Dual Row |

Contact Code

See 307/357 Series for Available Contact Options and "G" Dimension

| Contact Rows and Insulator Material | Description |
|-------------------------------------|--------------------------------|
| 1 | Single Row, Grey Polycarbonate |
| 2 | Dual Row, Grey Polycarbonate |

Mounting Options

| Mounting Options | Description |
|------------------|---|
| 54 | .156 (3.96) Dia. x .300 (7.62) Deep Holes |
| 57 | M3-0.5 Metric Threaded Inserts |
| 58 | #4-40 Unified Threaded Inserts |

- ◆ Contact Plating: Gold on the Mating Area, Tin on the Contact Tails, Nickel Underplate
- ◆ Current Rating: 5 Amperes Continuous
- ◆ For Additional Specifications, Refer to 307/357 Series.

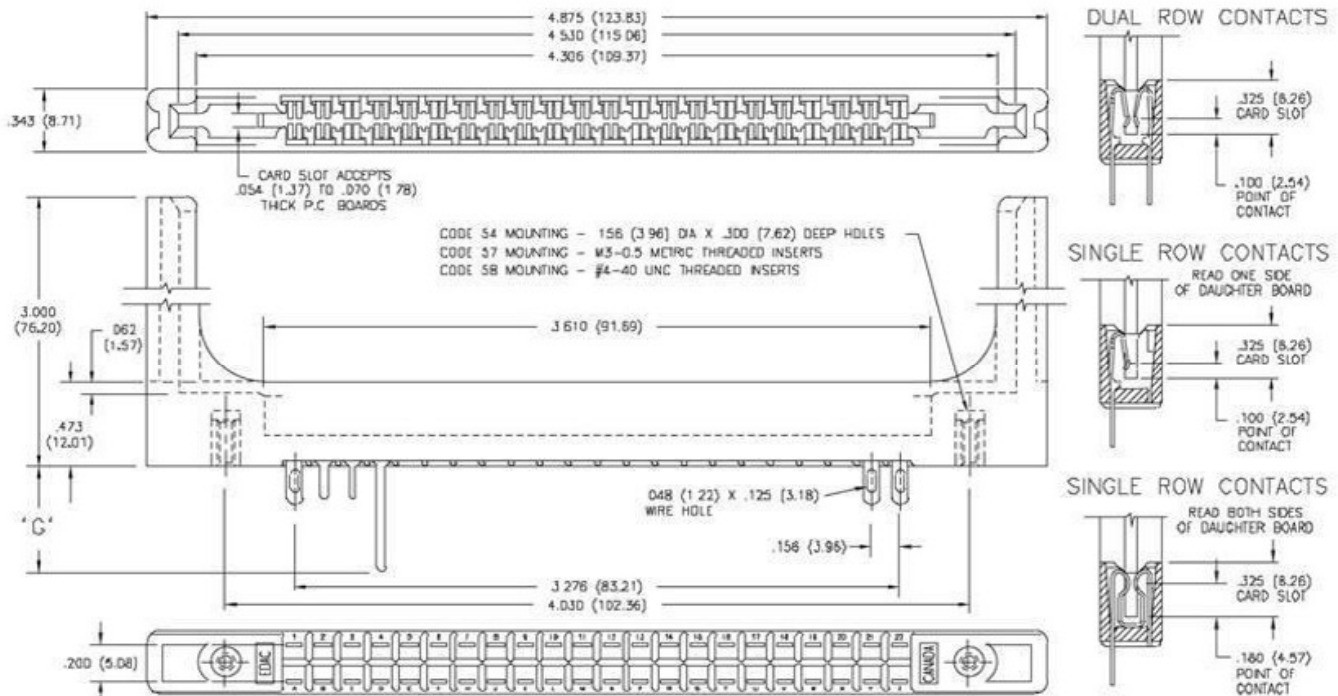

CARD EDGE CONNECTOR SERIES 323

Contact Spacing .156" (3.96mm)

323 SERIES ORDERING CODE

Example Part Number **323 - 086 - 540 - 802**

Series _____
 Total Number of Contacts _____
 Contact Code _____
 Mounting Options _____

Series 323

Total Number of Contacts 086

| Contact Code | Description & Tail Size | Tail Length "G" |
|--------------|-------------------------------------|-----------------|
| 542 | Wire Wrap .045 Square (1.14 Square) | .750(19.05) |

| Mounting Options ¹ | Description |
|-------------------------------|-----------------------------------|
| 802 | .144 (3.66) Dia. Mounting Holes |
| 803 | .116 (2.95) I.D. Floating Eyelets |
| 804 | .156 (3.96) Dia. Mounting Holes |
| 807 | M3-0.5 Metric Threaded Inserts |
| 808 | #4-40 Unified Threaded Inserts |

Ordering Code Notes

1) For details of the mounting options, refer to page 63.

SPECIFICATIONS

- ◆ Insulator Material: Polycarbonate, Colour: Grey
- ◆ Contact Material: Copper Alloy
- ◆ Contact Plating: Gold over Nickel for Entire Contact
- ◆ For Additional Specifications, Refer to 317 Series



FEATURES

- .156 (3.96) Contact Spacing x .200 (5.08) Row Spacing
- Accepts .062 (1.57) Nominal Thickness P.C. Board
- High Profile Insulator Body, .720 (18.29)
- Contact Termination .045 (1.14) Square Wire Wrap
- Variety of Mounting Options
- Accepts Between Contact and In-Contact Polarizing Keys

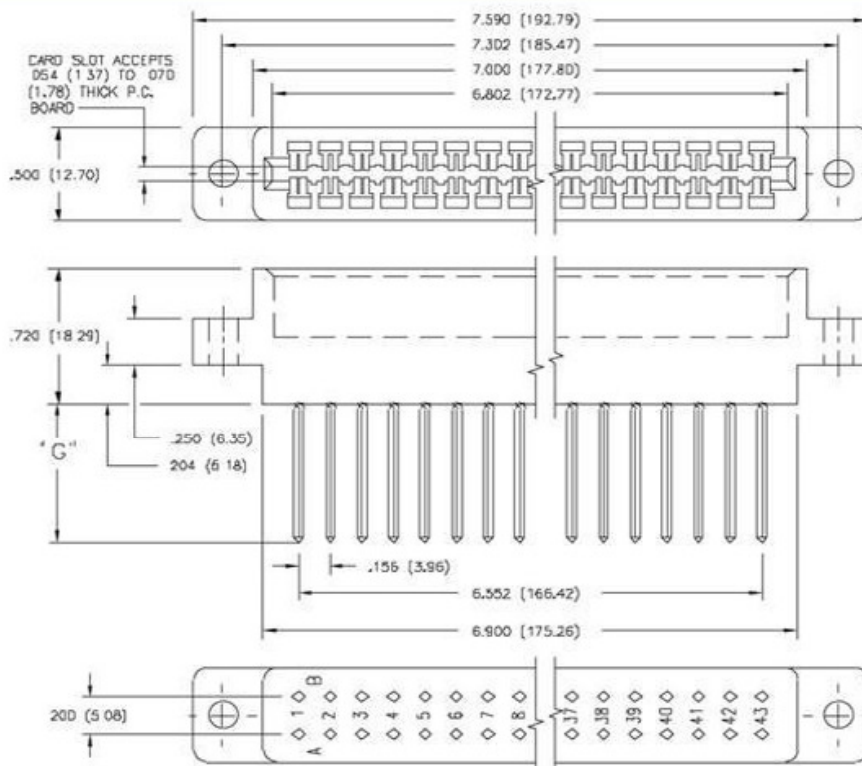

SECTION THROUGH CONTACT POSITION

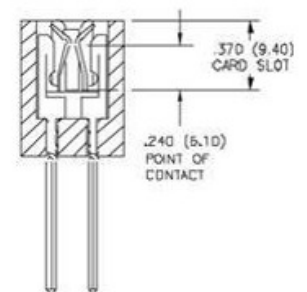

FOR 323 SERIES CONNECTOR, SPECIFY BETWEEN CONTACT POLARIZING KEY
 P/N 243-240-318 OR
 IN-CONTACT POLARIZING KEY
 P/N 321-240-328

368 SERIES EDGE CARD CONNECTOR

.156" (3.96mm) Contact Spacing

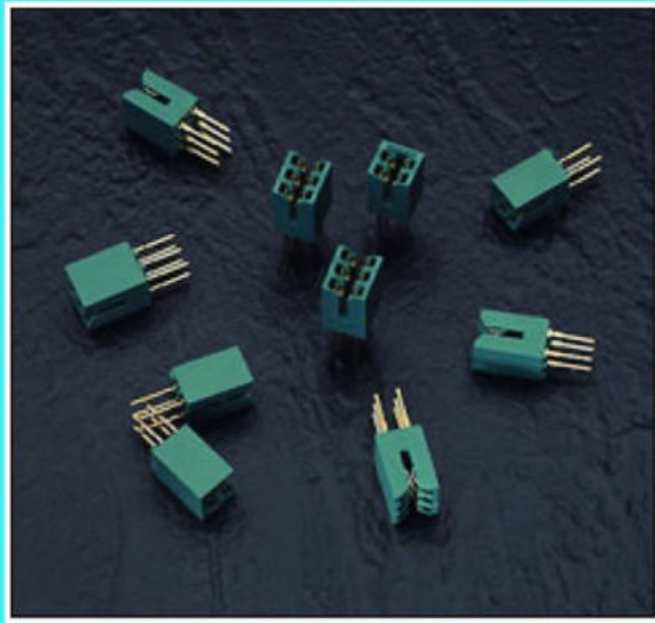

368 SERIES ORDERING CODE

Example Part Number **368 - 006 - 540 - 201**

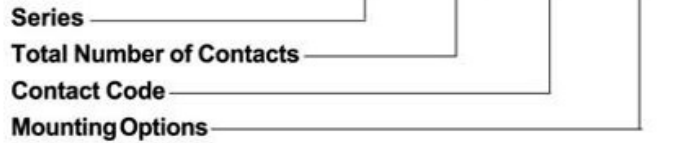

Series 368

| Total Number of Contacts | Connector Style |
|--------------------------|-----------------|
| 004 | End Module |
| 006 | Centre Module |

| Contact Code | Description & Tail Size | Tail Length "G" |
|--------------|-------------------------------------|-----------------|
| 520 | P.C. Tail .031 Square (0.79 Square) | .380 (9.65) |
| 540 | Wire Wrap .031 Square (0.79 Square) | .600 (15.24) |

Mounting Option 201

FEATURES

- .156 (3.96) Contact Spacing x .200 (5.08) Row Spacing
- Accepts .062 (1.57) Nominal Thickness P.C. Board
- High Profile Insulator Body, .630 (16.00)
- Press Fit Contact Termination Options include .031 (0.79) Square Wire Wrap & P.C. Tails
- Modular Design permits any Connector Length Assembly
- Accepts Between Contact and In-Contact Polarizing Keys

SPECIFICATIONS

- ◆ Insulator Material: Polyphenylene Sulphide, UL 94V-0, Colour: Green
- ◆ Contact Material: Copper Alloy
- ◆ Contact Plating: Gold over Nickel for Entire Contact
- ◆ Current Rating: 5 Amperes Continuous
- ◆ For Additional Specifications, Refer to 317 Series

4 CONTACT END MODULE

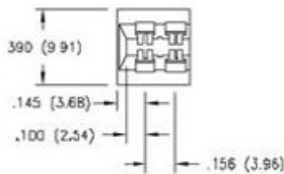

6 CONTACT CENTRE MODULE

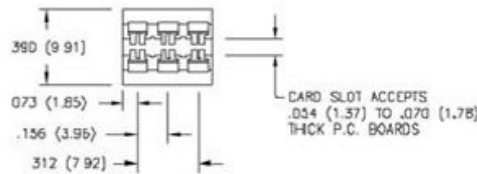

FOR BETWEEN CONTACT POLARIZING KEY, SPECIFY P/N 368-240-318

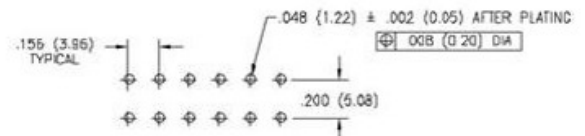
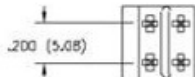
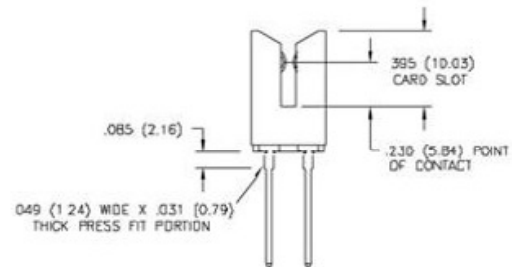
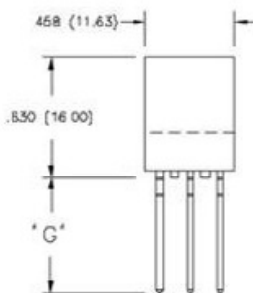
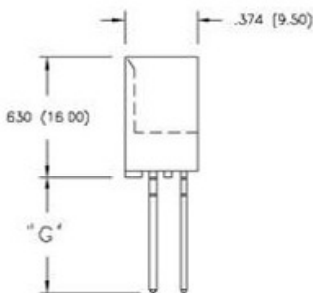

RECOMMENDED HOLE PATTERN FOR PRESS FIT

CARD EDGE CONNECTOR SERIES 327

Accepts .125" (3.18mm) Thick Board, Contact Spacing .156" (3.96mm)

327 SERIES ORDERING CODE

Example Part Number **327 - 044 - 520 - 2 09**

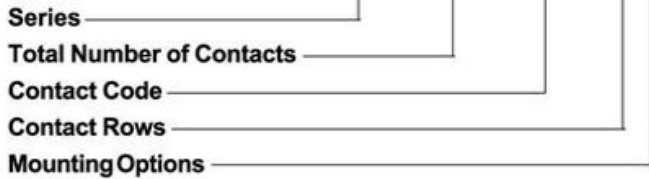

Series 327

| Total Number of Contacts | Contact Rows |
|--------------------------|--------------|
| 022 | Single Row |
| 044 | Dual Row |

| Contact Code | Description & Tail Size | Tail Length "G" |
|--------------|-------------------------------------|-----------------|
| 500 | Wire Hole .050 x .025 (1.27 x 0.64) | .260 (6.60) |
| 520 | P.C. Tail .025 Square (0.64 Square) | .175 (4.45) |
| 540 | Wire Wrap .025 Square (0.64 Square) | .560 (14.22) |

| Contact Rows | Description |
|--------------|-------------|
| 1 | Single Row |
| 2 | Dual Row |

| Mounting Options ¹ | Description |
|-------------------------------|---------------------------------|
| 01 | No Mounting Lugs |
| 09 | .163 (4.14) Dia. Mounting Holes |

Ordering Code Notes

1) For details of the mounting options, refer to page 63.

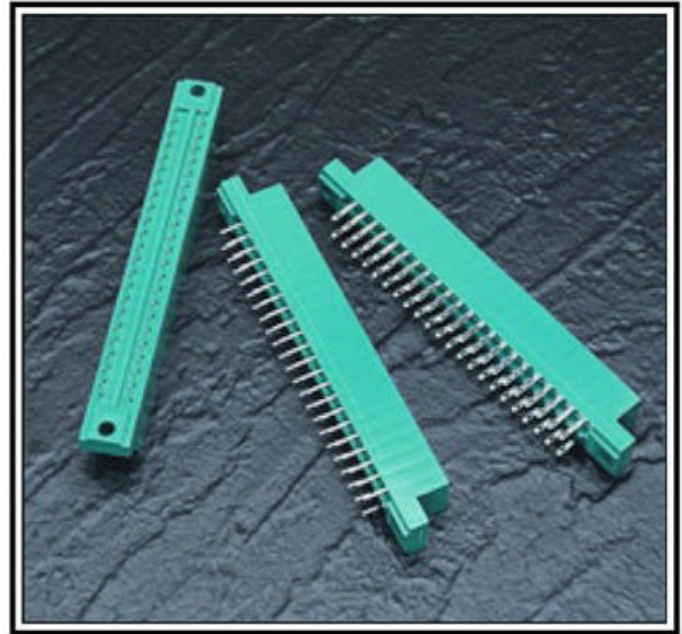

FEATURES

- .156 (3.96) Contact Spacing x .300 (7.62) Row Spacing
- Accepts .125 (3.18) Nominal Thickness P.C. Board
- High Profile Insulator Body, .600 (15.24)
- Contact Termination Options include P.C. Tail, Wire Hole & .025 (0.64) Square Wire Wrap
- Single or Dual Row Configurations
- Accepts In-Contact Polarizing Keys

SPECIFICATIONS

- ◆ Insulator Material: Polyphenylene Sulphide, 94V-0, Colour: Green
- ◆ Contact Material: Copper Alloy
- ◆ Contact Plating: Gold on the Mating Area, Tin on the Contact Tails, Nickel Underplate
- ◆ Current Rating: 3 Amperes Continuous
- ◆ Dielectric Withstanding Voltage: 1800 V AC rms at Sea Level Between Adjacent Contacts
- ◆ For Additional Specifications, Refer to 325 Series

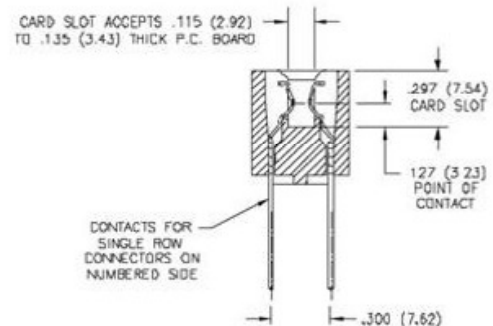
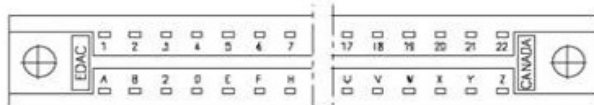
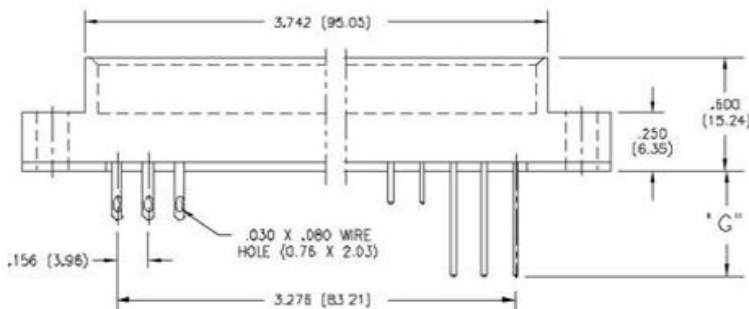
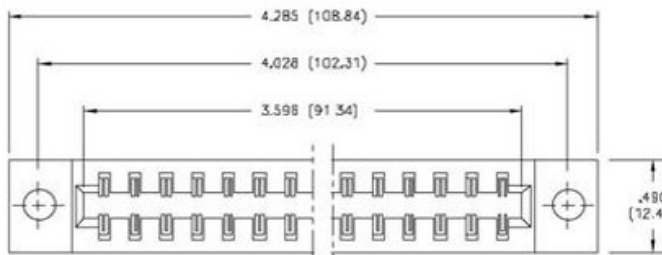

SECTION THROUGH CONTACT POSITION

FOR 327 SERIES CONNECTORS SPECIFY IN-CONTACT POLARIZING KEY P/N 325-240-328 CONSULT WITH EDAC REGARDING BETWEEN CONTACT POLARIZATION MOULDED INTO POSITION

379 SERIES CARD EDGE CONNECTOR

.150" (3.81mm) Contact Spacing



FEATURES

- .150 (3.81) Contact Spacing x .200 (5.08) Row Spacing
- Accepts .062 (1.57) Nominal Thickness P.C. Board
- High Profile Insulator Body, .600 (15.24)
- Contact Termination Options include P.C. Tail, Wire Wrap & Extender Board Bends
- Single or Dual Row Configurations
- Variety of Mounting Options
- Accepts In-Contact Polarizing Keys

SPECIFICATIONS

- ◆ Insulator Material: Thermoplastic Polyester, UL 94V-0, Colour: Black
- ◆ **Contact Material: Copper Alloy**
- ◆ Contact Plating: Gold on the Mating Area, Tin on the Contact Tails, Nickel Underplate
- ◆ Current Rating: 3 Amperes Continuous
- ◆ Contact Resistance: 10 Milliohms Maximum
- ◆ Dielectric Withstanding Voltage: 1800 V AC rms at Sea Level Between Adjacent Contacts
- ◆ Insulation Resistance: 5000 Megohms Minimum
- ◆ Operating Temperature: -65 to +105 Degrees C
- ◆ Insertion Force: 16 oz (4.45 N) Maximum per Contact Pair when Tested with a .070 (1.78) Thick Gauge
- ◆ Withdrawal Force: 1 oz (0.28 N) Minimum per Contact Pair when Tested with a .054 (1.37) Thick Gauge

379 SERIES ORDERING CODE

Example Part Number **379 - 040 - 520 - 2 08**

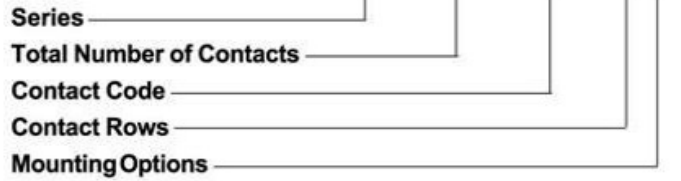

Series 379

| Total Number of Contacts | Contact Rows |
|--------------------------|--------------|
| 020 | Single Row |
| 040 | Dual Row |

| Contact Code ^{1,2} | Description & Tail Size | Tail Length "G" |
|-----------------------------|---|-----------------|
| 520 | P.C. Tail .030 x .018 (0.76 x 0.46) | .175 (4.45) |
| 521 | P.C. Tail .025 Square (0.64 Square) | .150 (3.81) |
| 523 | P.C. Tail .025 Square (0.64 Square) | .390 (9.91) |
| 524 | P.C. Tail .018 Square (0.46 Square) | .175 (4.45) |
| 540 | Wire Wrap .025 Square (0.64 Square) | .560(14.22) |
| 541 | Wire Wrap .025 Square (0.64 Square) | .750(19.05) |
| 542 | Wire Wrap .025 Square (0.64 Square) | .645(16.38) |
| 544 | Wire Wrap .050 x .025 (1.27 x 0.64) | .750(19.05) |
| 555 | Extender Board Bend (Code 500 Contacts) | |
| 556 | Extender Board Bend (Code 520 Contacts) | |
| 560 | Extender Board Bend (Code 523 Contacts) | |

| Contact Rows | Description |
|--------------|-------------|
| 1 | Single Row |
| 2 | Dual Row |

| Mounting Options ³ | Description |
|-------------------------------|-----------------------------------|
| 01 | No Mounting Lugs |
| 02 | .128 (3.25) Dia. Mounting Holes |
| 03 | .116 (2.95) I.D. Floating Eyelets |
| 04 | .156 (3.96) Dia. Mounting Holes |
| 07 | M3-0.5 Metric Threaded Inserts |
| 08 | #4-40 Unified Threaded Inserts |

Ordering Code Notes

- 1) For details of the extender board bends, refer to page 61.
- 2) Consult with Edac regarding 90 degree bend availability.
- 3) For details of the mounting options, refer to page 63.

CARD EDGE CONNECTOR SERIES 379

Contact Spacing .150" (3.81mm)

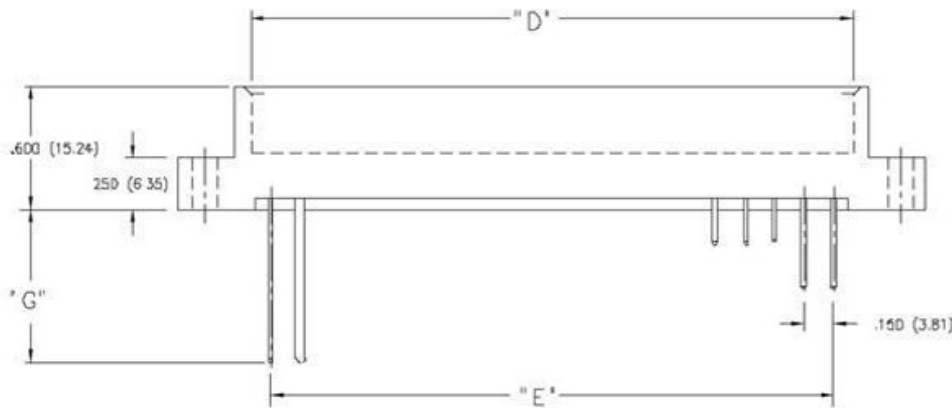
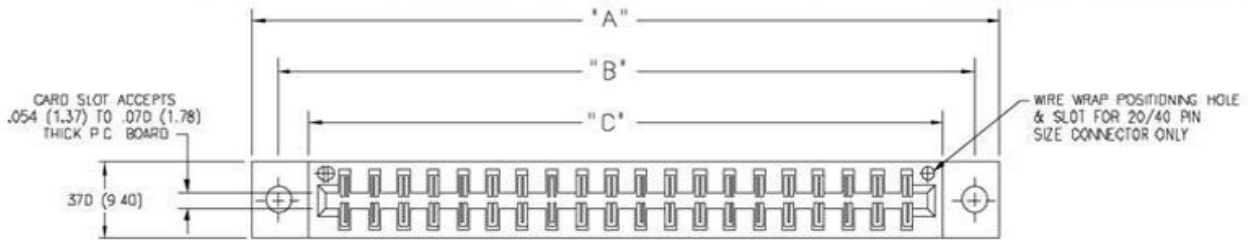

SECTION THROUGH CONTACT POSITION

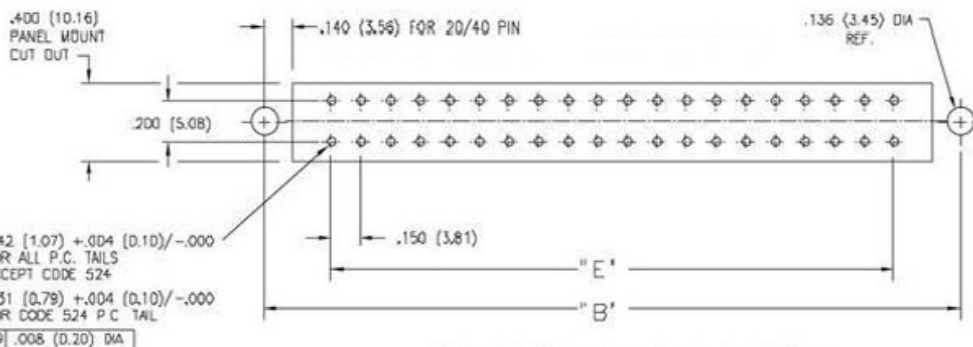
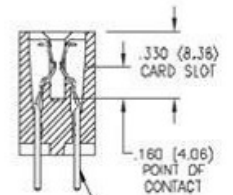

IN-CONTACT POLARIZING KEY

P/N 345-240-328



CONNECTOR MOUNTING PATTERN

CONSULT WITH EDAC REGARDING CONNECTORS WITH BETWEEN CONTACT POLARIZING KEY MOULDED INTO POSITION.

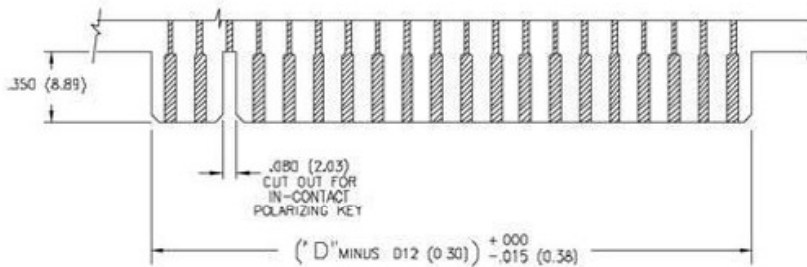

RECOMMENDED DAUGHTER BOARD

| NUMBER OF CONTACTS | | "A" | | "B" | | "C" | | "D" | | "E" | | COMMENTS |
|--------------------|------|-------|---------|-------|---------|-------|---------|-------|---------|-------|---------|---------------------------|
| Single | Dual | Inch | (mm) | Inch | (mm) | Inch | (mm) | Inch | (mm) | Inch | (mm) | |
| 20 | 40 | 3.875 | (98.43) | 3.610 | (91.69) | 3.300 | (83.82) | 3.140 | (79.76) | 2.850 | (72.39) | Position Numbers as Shown |

349 SERIES CARD EDGE CONNECTOR

.150" (3.81mm) Contact Spacing

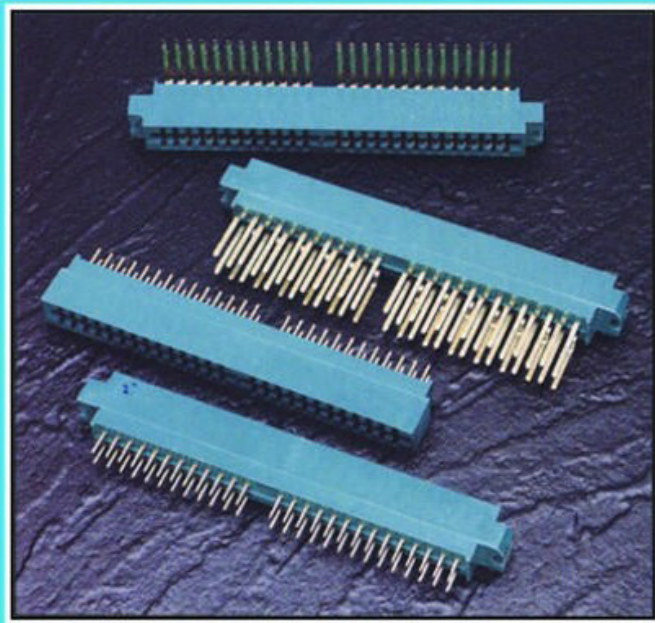

FEATURES

- .150 (3.81) Contact Spacing x .188 (4.78) Row Spacing
- Accepts .062 (1.57) Nominal Thickness P.C. Board
- High Profile Insulator Body, .720 (18.29)
- Contact Termination Options include P.C. Tail, .062 (1.57) x .031 (0.79) Wire Wrap, 90 Degree & Staggered Tail Bends
- Single or Dual Row Configurations
- Accepts Between Contact and In-Contact Polarizing Keys

SPECIFICATIONS

- ◆ Insulator Material: Polyphenylene Sulphide, UL 94V-0, Colour: Green

349 SERIES ORDERING CODE

Example Part Number **349 - 052 - 541 - 8 04**

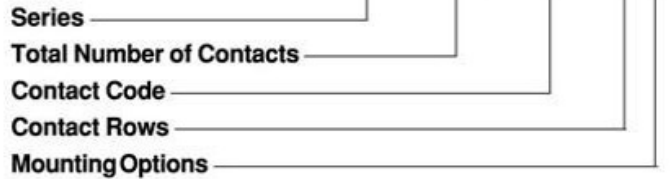

Series 349

| Total Number of Contacts | Contact Rows |
|--------------------------|--------------|
| 026 | Single Row |
| 052 | Dual Row |

| Contact Code | Description and Tail Size | Tail Length "G" |
|--------------|---|-----------------|
| 520 | P.C. Tail .031 Square (0.79 Square) | .260 (6.60) |
| 541 | Wire Wrap .062 x .031 (1.57 x 0.79) | .750 (19.05) |
| 558 | 90 Degree Bend (Code 541 Contacts) | |
| 561 | Staggered Tail Bend (Code 541 Contacts) | |

| Contact Rows | Description |
|--------------|-------------|
| 6 | Single Row |
| 8 | Dual Row |

| Mounting Options | Description |
|------------------|---------------------------------|
| 01 | No Mounting Lugs |
| 04 | .152 (3.86) Wide Mounting Slots |

- ◆ **Contact Material: Copper Alloy**
- ◆ **Contact Plating: Gold on the Mating Area, Tin on the Contact Tails, Nickel Underplate**
- ◆ **Current Rating: 5 Amperes Continuous**
- ◆ **For Additional Specifications, Refer to 336 Series**

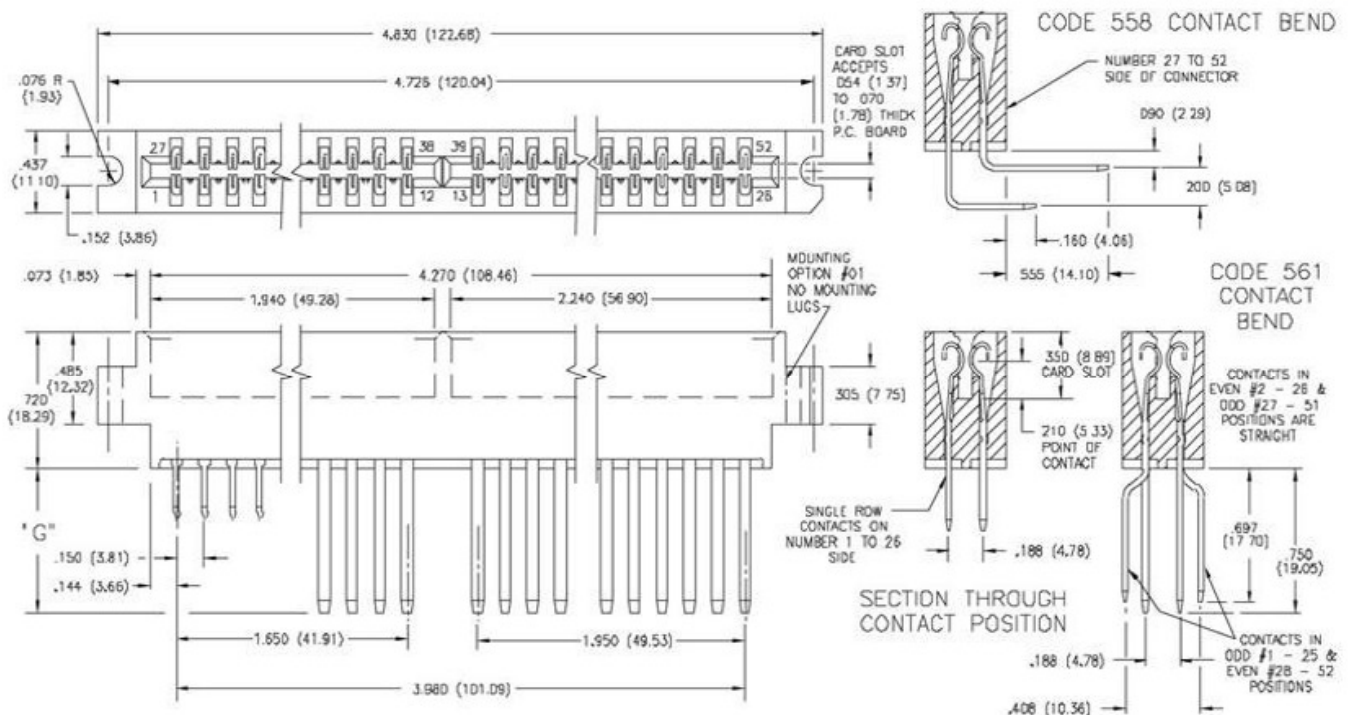

CARD EDGE CONNECTOR SERIES 334

Contact Spacing .150" (3.81mm)

384 SERIES ORDERING CODE

Example Part Number **334 - 018 - 525 - 102**

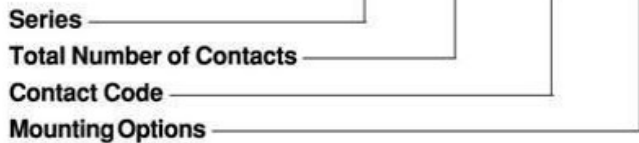

Series 334

Total Number of Contacts 018

| Contact Code ¹ | Description & Tail Size | Tail Length "G" |
|---------------------------|-------------------------------------|-----------------|
| 505 | Wire Hole .087 x .013 (2.21 x 0.33) | .282 (7.16) |
| 525 | P.C. Tail .046 x .013 (1.17 x 0.33) | .213 (5.41) |
| 527 | P.C. Tail .046 x .013 (1.17 x 0.33) | .358 (9.09) |
| 531 | P.C. Tail .023 x .013 (0.58 x 0.33) | .213 (5.41) |
| 545 | Wire Wrap .046 x .013 (1.17 x 0.33) | .520 (13.21) |

| Mounting Options ² | Description |
|-------------------------------|-----------------------------------|
| 101 | No Mounting Lugs |
| 102 | .128 (3.25) Dia. Mounting Holes |
| 103 | .116 (2.95) I.D. Floating Eyelets |
| 104 | .156 (3.96) Dia. Mounting Holes |
| 107 | M3-0.5 Metric Threaded Inserts |
| 108 | #4-40 Unified Threaded Inserts |

Ordering Code Notes

- 1) For contacts with overall tin plating, change the first digit of the contact code from 5 to 4.
- 2) For details of the mounting options, refer to page 63.

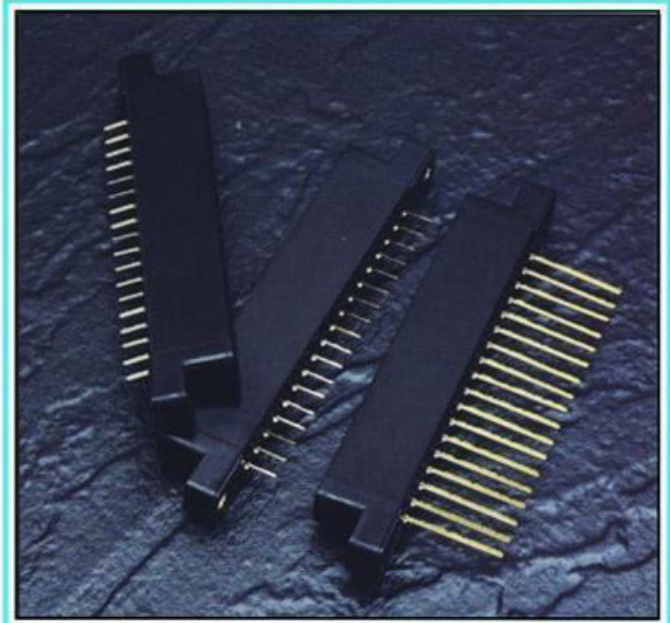

FEATURES

- UL Recognized
- .150 (3.81) Contact Spacing, Single Contact Row
- Accepts .062 (1.57) Nominal Thickness P.C. Board
- High Profile Insulator Body, .600 (15.24)
- Contact Termination Options include P.C. Tail, Wire Hole & Wire Wrap
- Variety of Mounting Options
- Accepts Between Contact Polarizing Keys

SPECIFICATIONS

- Insulator Material: Thermoplastic Polyester, UL 94V-0, Colour: Green
- Contact Material: Copper Alloy
- Contact Plating: Gold on the Mating Area, Tin on the Contact Tails, Nickel Underplate
- Current Rating: 5 Amperes Continuous
- For Additional Specifications, Refer to 307/357 Series

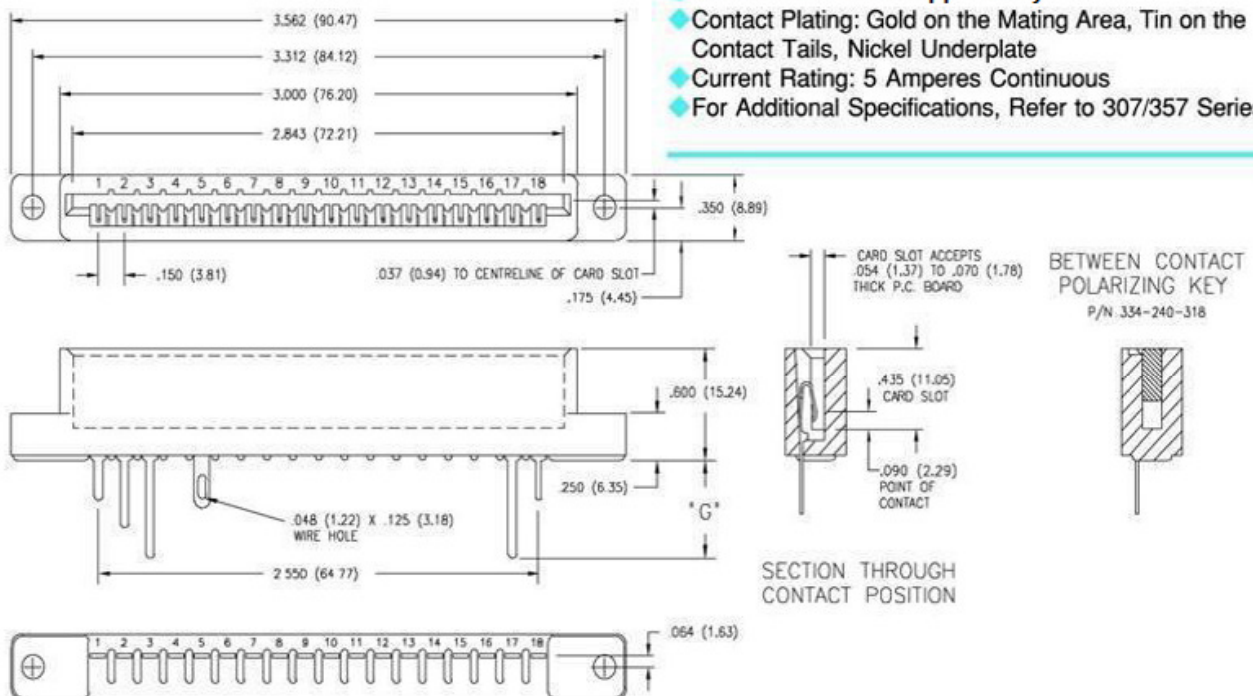

243 SERIES CARD EDGE CONNECTOR

.200" (5.08mm) Contact Spacing

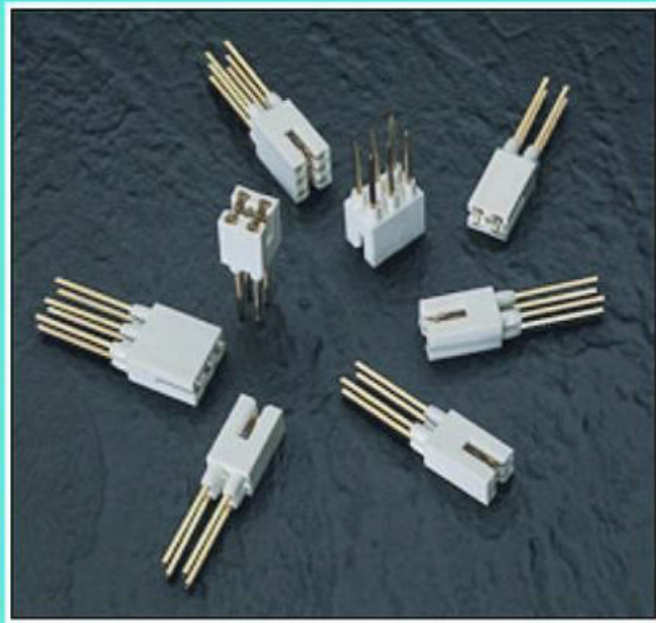

243 SERIES ORDERING CODE

Example Part Number **243 - 006 - 542 - 201**

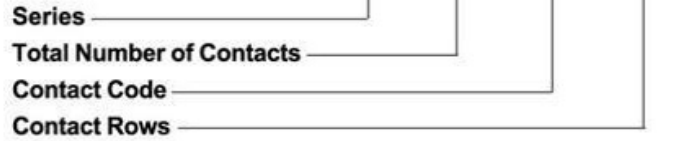

| | | |
|--------------------------|-------------------------------------|-----------------|
| Series 243 | | |
| Total Number of Contacts | | Contact Rows |
| 002 or 003 | | Single Row |
| 004 or 006 | | Dual Row |
| Contact Code | Description & Tail Size | Tail Length "G" |
| 542 | Wire Wrap .045 Square (1.14 Square) | .650(16.51) |
| Contact Rows | | Description |
| 101 | | Single Row |
| 201 | | Dual Row |

FEATURES

- .200 (5.08) Contact Spacing x .200 (5.08) Row Spacing
- Accepts .062 (1.57) Nominal Thickness P.C. Board
- High Profile Insulator Body, .656 (16.66)
- Insulating Bushings Press into Metal Backplane
- Modular Design permits any Connector Length Assembly
- Contact Termination .045 (1.14) Square Wire Wrap
- Accepts Between Contact and In-Contact Polarizing Keys

SPECIFICATIONS

- ◆ Insulator Material: Thermoplastic Polyester, UL 94V-0, Colour: White
- ◆ Contact Material: Copper Alloy
- ◆ Contact Plating: Gold over Nickel for Entire Contact
- ◆ Current Rating: 5 Amperes Continuous
- ◆ Contact Resistance: 10 Milliohms Maximum
- ◆ Dielectric Withstanding Voltage: 1800 V AC rms at Sea Level Between Adjacent Contacts
- ◆ Insulation Resistance: 5000 Megohms Minimum
- ◆ Operating Temperature: -65 to +105 Degrees C
- ◆ Insertion Force: 16 oz (4.45 N) Maximum per Contact Pair when Tested with a .070 (1.78) Thick Gauge
- ◆ Withdrawal Force: 1 oz (0.28 N) Minimum per Contact Pair when Tested with a .054 (1.37) Thick Gauge

TWO OR FOUR CONTACT ASSEMBLY

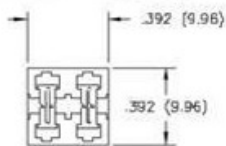

THREE OR SIX CONTACT ASSEMBLY

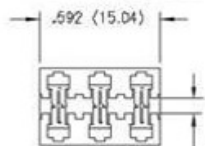

CARD SLOT ACCEPTS .054 (1.37) TO .070 (1.78) THICK P.C. BOARD

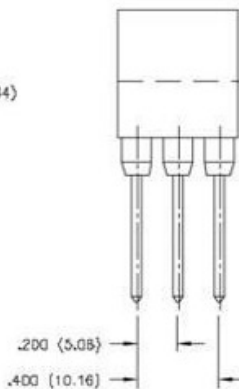
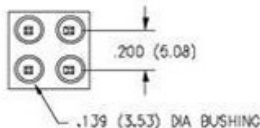
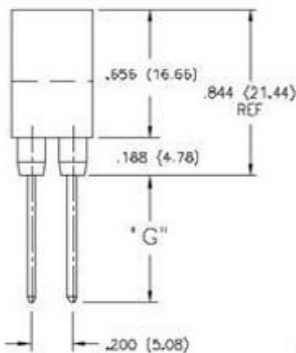

FOR IN-CONTACT POLARIZING USE KEY P/N 321-240-328
FOR BETWEEN CONTACT POLARIZING USE KEY P/N 243-240-318

DUAL ROW

SINGLE ROW

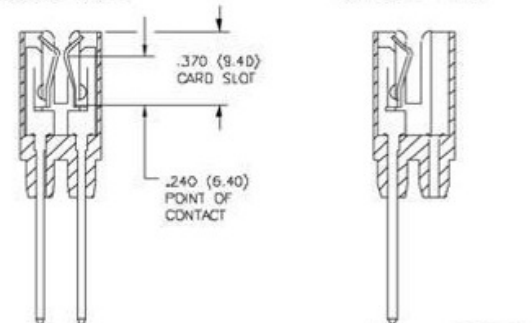

PANEL HOLE PATTERN 4 PIN / 6 PIN MODULE

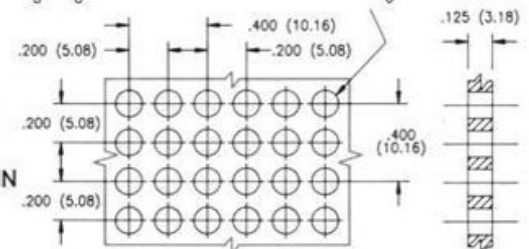

800 SERIES CARD EDGE CONNECTORS

For High Temperature Environments

SERIES 807

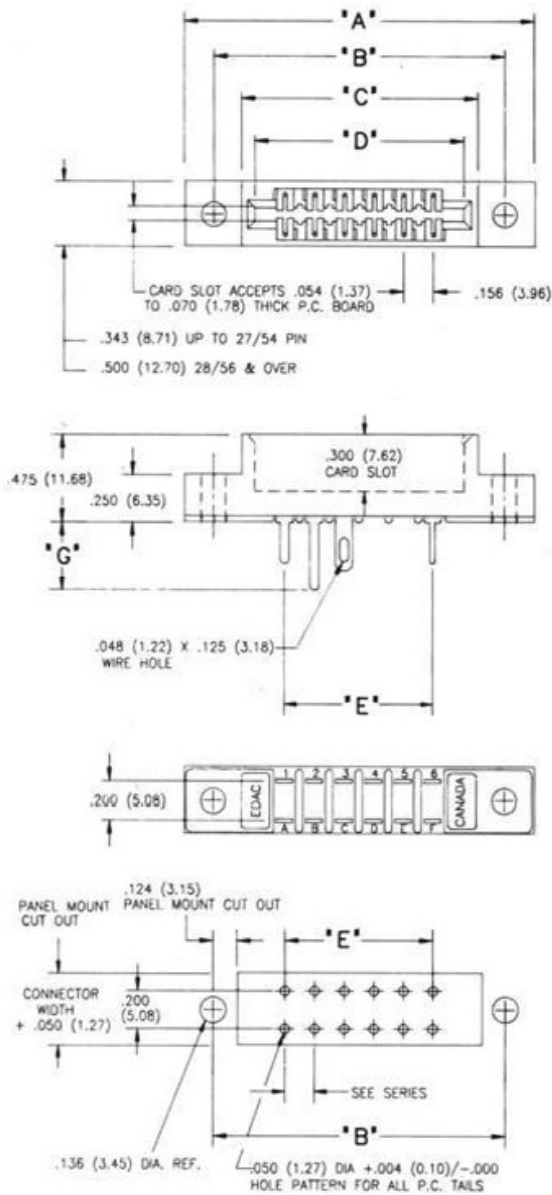

CONNECTOR MOUNTING PATTERN
ALL SERIES

SERIES 842,845,846,837,833

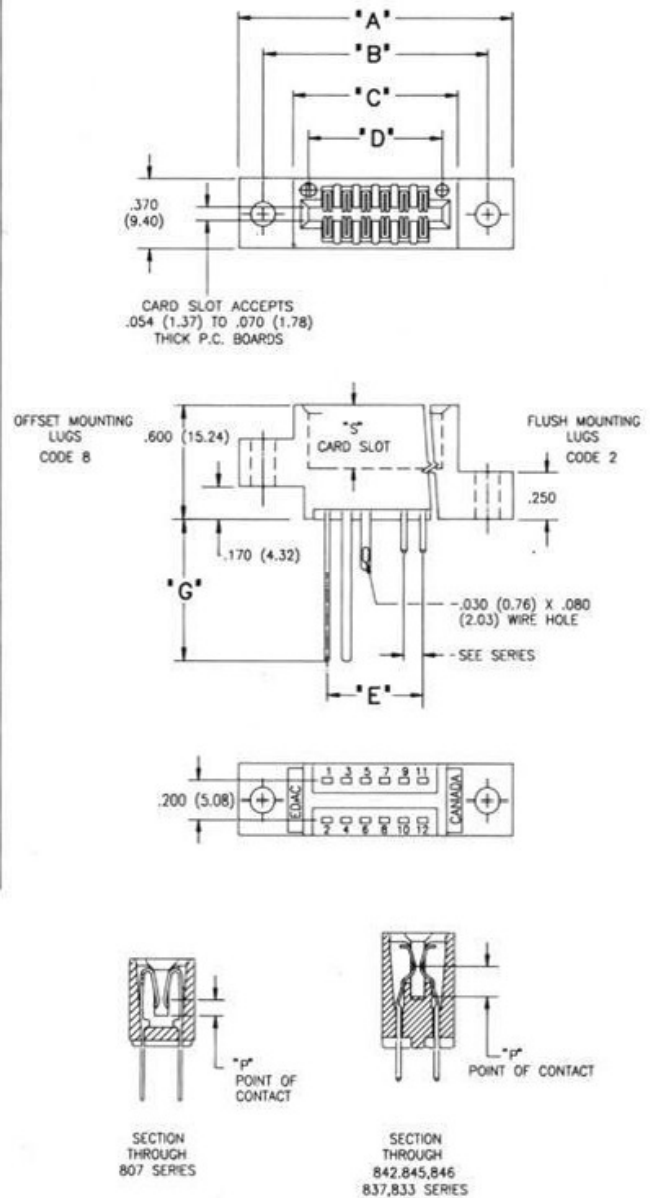

| PITCH | SERIES | DIMENSIONS | "S" | "p" |
|-------------|--------|----------------------------------|--------------|-------------|
| .100 (2.54) | 842 | See chart for 342/392 on page 67 | .410 (10.41) | .240 (6.10) |
| .100 (2.54) | 845 | See chart for 345/395 on page 67 | .410 (10.41) | .240 (6.10) |
| .125 (2.54) | 846 | See chart for 346/396 on page 71 | .330 (8.39) | .160 (4.06) |
| .156 (3.96) | 837 | See chart for 337 on page 69 | .330 (8.39) | .160 (4.06) |
| .156 (3.96) | 833 | See chart for 333 on page 69 | .388 (9.86) | .218 (5.43) |
| .156 (3.96) | 807 | See chart for 307 on page 69 | .300 (7.62) | .095 (2.41) |

CONTACT TAIL BENDS - CARD EDGE CONNECTORS

Standard Bend Details

CONTACT CODE 553 - 90 DEGREE BEND

- Applicable for 307, 322 and 357 Series
- For 307 and 357 Series with .500 (12.70) Connector Width, Longer Contacts are Used and Cut to Length Indicated

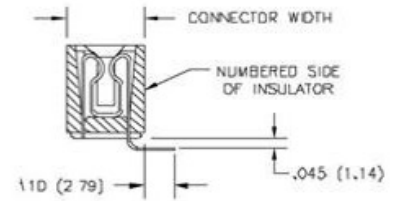

CONTACT CODE 553

CONTACT CODE 554 - 90 DEGREE BEND

- Applicable for 307, 322 and 357 Series
- This Bend is Not Recommended for 307 and 357 Series with .500 (12.70) Connector Width

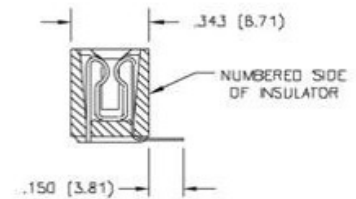

CONTACT CODE 554
BEND USES WIRE HOLE CONTACTS

CONTACT CODE 555 - EXTENDER BOARD BEND

| Applicable Series | "A" |
|---|-------------|
| 305, 307, 310, 315, 322, 355, 357 | .265 (6.73) |
| 333, 337, 340, 345, 346, 379, 387, 395, 395-AT, 396 | .245 (6.22) |
| 341, 391 | .205 (5.21) |
| 342, 392 | .255 (6.48) |

- For Contact Bend to Accept .125 (3.18) Thick Extender Board, Specify Contact Code 552

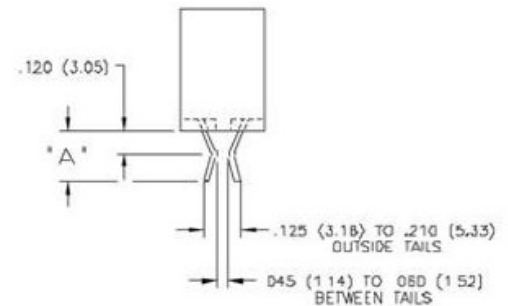

CONTACT CODE 555
BEND USES WIRE HOLE CONTACTS

CONTACT CODE 556 - EXTENDER BOARD BEND

| Applicable Series | "A" |
|---|-------------|
| 305, 307, 310, 315, 322, 355, 357 | .195 (4.95) |
| 333, 337, 340, 345, 346, 379, 387, 395, 395-AT, 396 | .170 (4.32) |
| 341, 391 | .235 (5.97) |
| 342, 392 | .180 (4.57) |

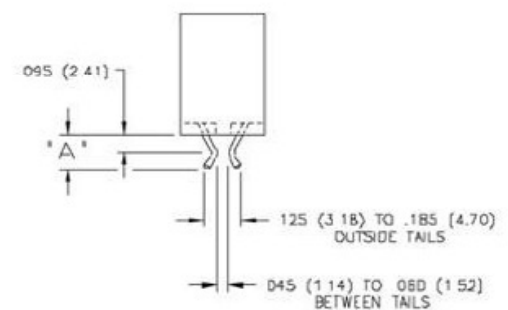

CONTACT CODE 556

CARD EDGE CONNECTORS - CONTACT TAIL BENDS

Standard Bend Details

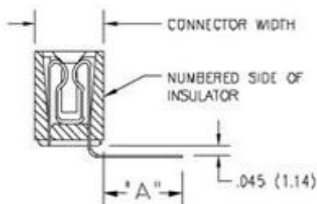

CONTACT CODE 557

CONTACT CODE 557 - 90 DEGREE BEND

| Applicable Series | Connector Width | "A" |
|-------------------|-----------------|-------------|
| 307, 322, 357 | .343 (8.71) | .392 (9.96) |
| 305, 357 | .500 (12.70) | .314 (7.98) |

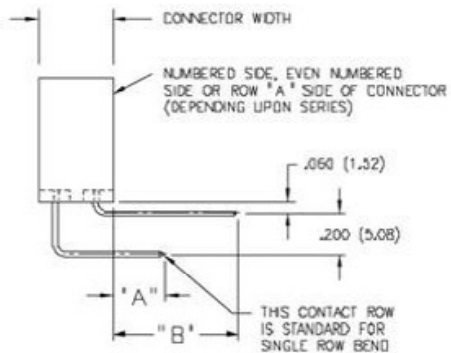

CONTACT CODE 558

CONTACT CODE 558 - 90 DEGREE BEND

| Applicable Series | Connector Width | "A" | "B" |
|--------------------------------------|-----------------|-------------|--------------|
| 307, 322, 357 | .343 (8.71) | .240 (6.10) | .240 (6.10) |
| 307, 357 | .500 (12.70) | .162 (4.11) | .162 (4.11) |
| 333, 337, 340, 345, 387, 395, 395-AT | .370 (9.40) | .235 (5.97) | .635 (16.13) |
| 342, 392 | .370 (9.40) | .245 (6.22) | .645 (16.38) |
| 346, 396 | .370 (9.40) | .210 (5.33) | .660 (16.76) |

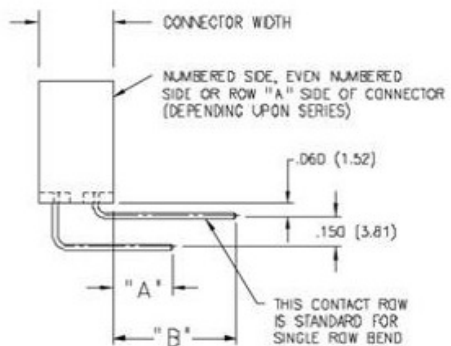

CONTACT CODE 559

CONTACT CODE 559 - 90 DEGREE BEND

| Applicable Series | Connector Width | "A" | "B" |
|--------------------------------------|-----------------|-------------|--------------|
| 307, 322, 357 | .343 (8.71) | .290 (7.37) | .240 (6.10) |
| 307, 357 | .500 (12.70) | .212 (5.38) | .162 (4.11) |
| 333, 337, 340, 345, 387, 395, 395-AT | .370 (9.40) | .285 (7.24) | .635 (16.13) |
| 342, 392 | .370 (9.40) | .295 (7.49) | .645 (16.38) |
| 346, 396 | .370 (9.40) | .260 (6.60) | .660 (16.76) |

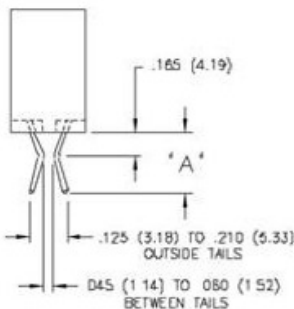

CONTACT CODE 560

CONTACT CODE 560 - EXTENDER BOARD BEND

| Applicable Series | "A" |
|---|-------------|
| 307, 310, 322, 357 | .343 (8.71) |
| 333, 337, 340, 345, 379, 387, 395, 395-AT | .375 (9.53) |
| 341, 391 | .365 (9.27) |
| 342, 392 | .385 (9.78) |
| 346, 396 | .335 (8.51) |

MOUNTING OPTIONS - CARD EDGE CONNECTORS

Standard Mounting Details

CODE x01 - NO MOUNTING LUGS

- Applicable for 303, 305, 306, 307, 310, 315, 316, 317, 321, 325, 327, 333, 336, 337, 338, 340, 341, 342, 345, 346, 355, 356, 357, 379, 384, 387, 391, 392, 395 and 396 Series

CODE x02, x04 & x09 - THROUGH MOUNTING HOLES

| Applicable Series | Code x02 "A" Dia. | Code x04 "A" Dia. | Code x09 "A" Dia. |
|---|-------------------------------------|----------------------|----------------------|
| 305, 306, 307, 310, 315, 316, 321, 333, 337, 338, 340, 341, 345, 346, 355, 356, 357, 379, 384, 387, 391, 395, 396 | .128 (3.25) | .156 (3.96) | — |
| 317, 323 | .144 (3.66) | .156 (3.96) | — |
| 325 | — | — | .160 (4.06) |
| 327 | — | — | .163 (4.14) |
| 342, 392 | .128(3.25) x .146 (3.71) Slot | .156 (3.96) | — |

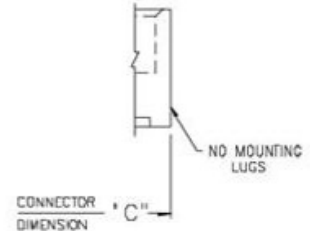

MOUNTING OPTION
CODE x01

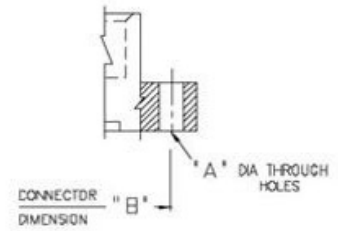

MOUNTING OPTION
CODES x02, x04 & x09

CODE x03 - FLOATING EYELETS

| Applicable Series | "A" |
|--|-------------|
| 305, 306, 307, 310, 315, 316, 317, 321, 323, 333, 337, 338, 341, 345, 346, 355, 356, 357, 379, 384, 387, 391, 395, 396 | .328 (8.33) |
| 342, 392 | .348 (8.84) |

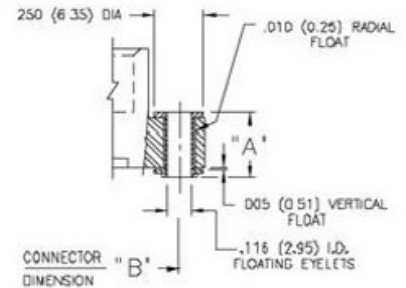

MOUNTING OPTION
CODE x03

CODE x07 & x08 - THREADED INSERTS

- Applicable for 305, 306, 307, 310, 315, 316, 317, 321, 323, 325, 333, 337, 338, 341, 342, 345, 346, 356, 357, 379, 384, 387, 391, 392, 395 and 396 Series
- See Code x12 for Side Mounting Threaded Inserts

CODE x12 - SIDE MOUNTING HOLES

| Applicable Series | "A" |
|---|-------------|
| 307, 333, 337, 345, 346, 357, 387, 395, 396 | .125 (3.18) |
| 342, 392 | .135 (3.43) |

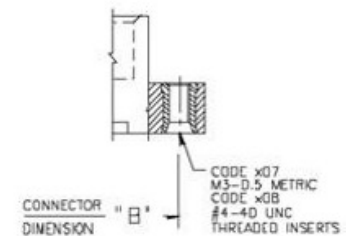

MOUNTING OPTION
CODES x07 & x08

- Series Listed Above based on Availability of 90 Degree Bend Contact Tails. Side Mounting Holes may also be Used for Other Card Edge Connectors with a Lug Height of .250 (6.35) or Greater.
- For Side Mounting with Threaded Inserts, Specify Code x17 for M3-0.5 Metric Threads or Code x18 for #4-40 Unified Threads.

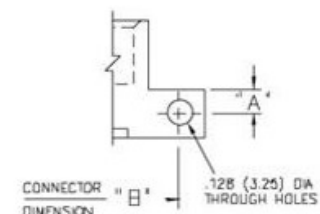

MOUNTING OPTION
CODE x12

CARD EDGE CONNECTORS - MOUNTING OPTIONS

Standard Mounting Details

CODE x58 & x68 - OFFSET CARD GUIDES

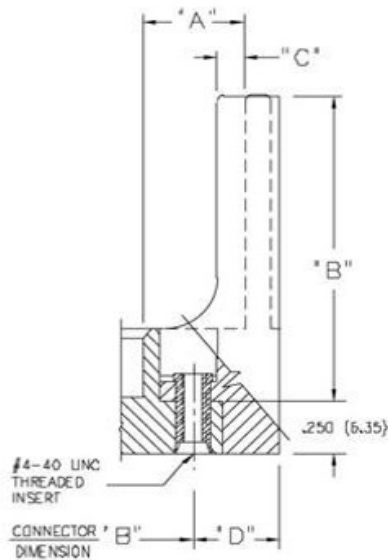

MOUNTING OPTION
CODES x58 & x68

| Applicable Series for Code x58 Guides | "A" | "B" | "C" | "D" |
|---|-------------|--------------|------------|-------------|
| 305, 306, 307, 315, 316, 337, 338, 355, 356, 357, 387 | .468(11.89) | 2.755(69.98) | .125(3.18) | .423(10.74) |
| 345, 395 | .468(11.89) | 2.755(69.98) | .120(3.05) | .402(10.21) |
| 346, 396 | .468(11.89) | 2.755(69.98) | .120(3.05) | .398(10.11) |
| Applicable Series for Code x68 Guides | "A" | "B" | "C" | "D" |
| 305, 306, 307, 315, 316, 337, 338, 355, 356, 357, 387 | .344(8.74) | 2.505(63.63) | .060(1.52) | .242(6.15) |

- For Card Guides with .128 (3.25) Dia. Through Hole Inserts, Specify Code x52 or x62.
- For Card Guides with M3-0.5 Metric Threaded Inserts, Specify Code x57 or x67.
- For Field Assembly of Card Guides, Refer to Page 72.

CODE x78 & x88 - IN-LINE CARD GUIDES

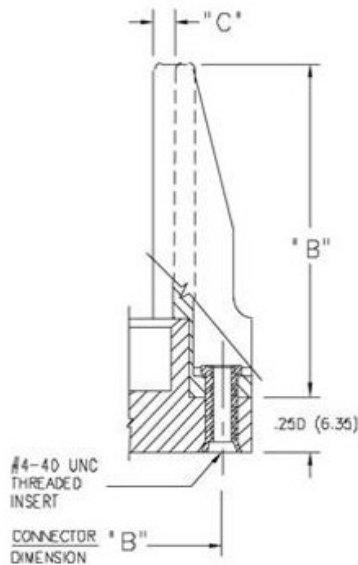

MOUNTING OPTION
CODES x78 & x88

| Applicable Series for Code x78 Guides | "B" | "C" |
|---|--------------|------------|
| 305, 306, 307, 315, 316, 337, 338, 355, 356, 357, 387 | 1.550(39.37) | .090(2.29) |
| 317 | 1.712(43.48) | .110(2.79) |
| 345, 395 | 2.750(69.85) | .083(2.11) |
| 346, 396 | 2.750(69.85) | .091(2.31) |
| Applicable Series for Code x88 Guides | "B" | "C" |
| 345, 395 | 1.250(31.75) | .083(2.11) |

- In-Line Card Guides are Not Suitable for the Flush Mounting Lug Versions of 337, 387, 346 or 396 Series
- For Card Guides with .128 (3.25) Dia. Through Hole Inserts, Specify Code x72 or x82.
- For Card Guides with M3-0.5 Metric Threaded Inserts, Specify Code x77 or x87
- For Field Assembly of Card Guides, Refer to Page 72.

CARD GUIDES

243, 368 Series Card Guides



368 SERIES CARD GUIDE FEATURES

- Accepts .062 (1.57) Nominal Thickness P.C. Board
- Stand-Alone Guide with "Back to Back" Board Slots
- Through Mounting Holes for #4 or M3 Screws or #6 Self-Threading Screws

SPECIFICATIONS

- ◆ Guide Material: Thermoplastic Polyester, UL 94V-0, Colour: Green
- ◆ Operating Temperature: -65 to +105 Degrees C

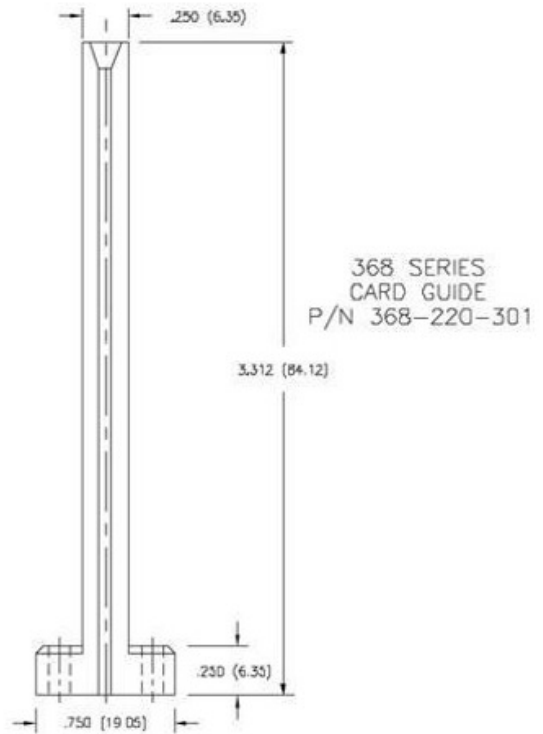
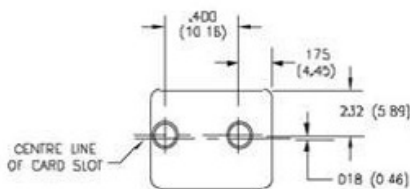
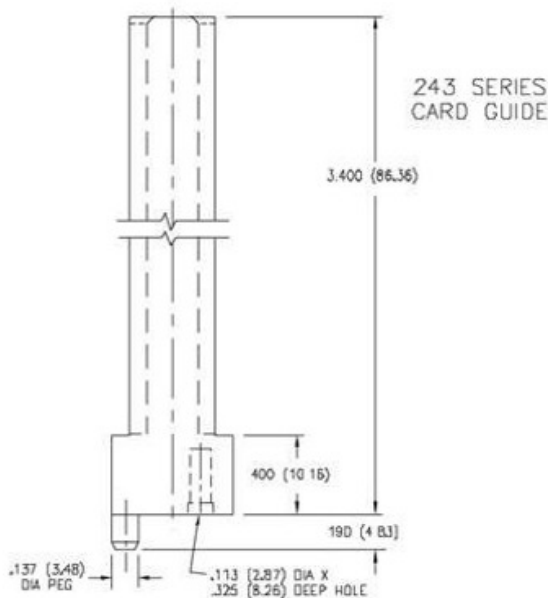
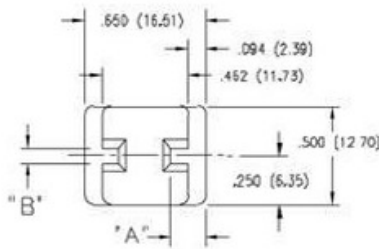
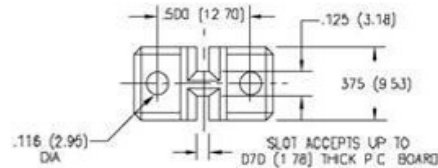

243 SERIES CARD GUIDE FEATURES

- Accepts .062 (1.57) or .250 (6.35) Nominal Thickness P.C. Board
- Stand-Alone Guide with "Back to Back" Board Slots
- Mounting Peg and Hole for #5 Self-Threading Screw

SPECIFICATIONS

- ◆ Guide Material: Polycarbonate, Colour: Grey
- ◆ Operating Temperature: -65 to +105 Degrees C

243 SERIES CARD GUIDE DIMENSIONS

| PartNumber | "A" | "B"(Accepts Nominal P.C. Board) |
|-------------|-------------|---------------------------------|
| 243-220-301 | .187 (4.75) | .062 (1.57) Thick |
| 243-220-302 | .237 (6.02) | .250 (6.35) Thick |

307/317/345/346 SERIES CARD GUIDE FEATURES

- Accepts .062 (1.57) Nominal Thickness P.C. Board
- For Field Assembly of Card Guides to a Connector with Code 04 Mounting - .156 (3.96) Dia. Mounting Holes. Use an Alignment Bushing Part Number 345-250-442-102, a Hex or Round Head Screw, Washer and Nut to hold the Assembly to a Circuit Board.

SPECIFICATIONS

- ◆ Guide Material: Thermoplastic Polyester, UL94V-0, Colour: Green, Black Colour Available Upon Request
- ◆ Operating Temperature: -65 to +105 Degrees C

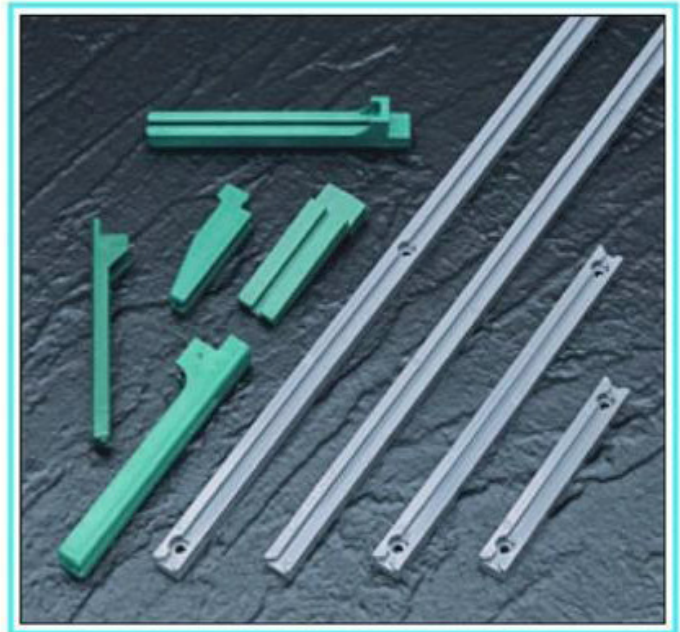
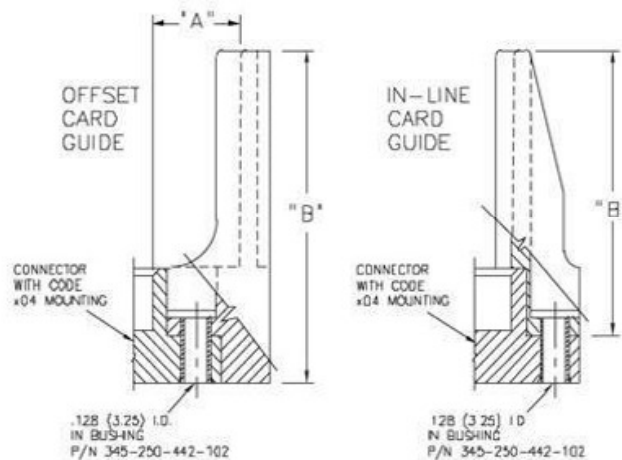

307/317/345/346 SERIES CARD GUIDES

| Part Number | Style | "A" | "B" | Used for Connector Series |
|-------------|---------|--------------|---------------|---------------------------|
| 307-220-058 | Offset | .468 (11.89) | 3.000 (76.20) | 305, 306, 307, 315, |
| 307-220-068 | Offset | .344 (8.74) | 2.750 (69.85) | 316, 337, 338, 355, |
| 307-220-078 | In-Line | — | 1.550 (39.37) | 356, 357, 387 |
| 317-220-078 | In-Line | — | 1.712 (43.48) | 317 |
| 345-220-058 | Offset | .468 (11.89) | 3.000 (76.20) | 345, 395 |
| 345-220-078 | In-Line | — | 2.750 (69.85) | |
| 345-220-088 | In-Line | — | 1.250 (31.75) | |
| 346-220-058 | Offset | .468 (11.89) | 3.000 (76.20) | 346, 396 |
| 346-220-078 | In-Line | — | 2.750 (69.85) | |

Notes for Card Guides Chart

- 1) Card guide part number 307-220-078 is not suitable for 337 or 387 series connectors with flush mounting lugs.
- 2) Card guide part number 346-220-078 is not suitable for 346 or 396 series connectors with flush mounting lugs.

616 SERIES UNI-GUIDE FEATURES

- Variety of Sizes for Equipment Design Flexibility
- Accepts .062 (1.57) Nominal Thickness P.C. Board
- Supports P.C. Board and Provides Board to Connector Alignment
- May be Installed in a "Back to Back" Configuration
- Easy Installation Using .093 (2.36) Dia. Eyelets or Pop Rivets or Two Sided Tape (Very High Bond)

SPECIFICATIONS

- ◆ Uni-Guide Material: Polycarbonate, Colour: Grey
- ◆ Operating Temperature: -65 to +105 Degrees C

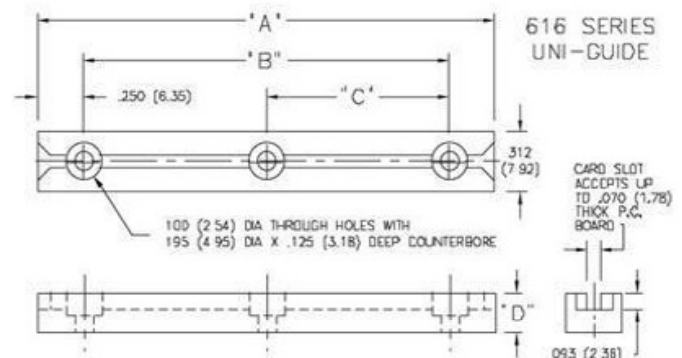

616 SERIES UNI-GUIDES

| Part Number | "A" | "B" | "C" | "D" | Mounting Holes |
|-------------|-----------------|-----------------|----------------|-------------|----------------|
| 616-220-301 | 6.375 (161.92) | 5.875 (149.23) | — | .218 (5.54) | 2 |
| 616-220-302 | 2.500 (63.50) | 2.000 (50.80) | — | .218 (5.54) | 2 |
| 616-220-303 | 4.500 (114.30) | 4.000 (101.60) | — | .218 (5.54) | 2 |
| 616-220-304 | 5.500 (139.70) | 5.000 (127.00) | — | .218 (5.54) | 2 |
| 616-220-305 | 8.000 (203.20) | 7.500 (190.50) | 3.750 (95.25) | .218 (5.54) | 3 |
| 616-220-306 | 9.000 (228.60) | 8.500 (215.90) | 4.250 (107.95) | .218 (5.54) | 3 |
| 616-220-307 | 11.000 (279.40) | 10.500 (266.70) | 5.250 (133.35) | .218 (5.54) | 3 |
| 616-220-310 | 9.000 (228.60) | — | — | .141 (3.58) | 0 |
| 616-220-311 | 9.000 (228.60) | — | — | .205 (5.21) | 0 |
| 616-220-313 | 11.000 (279.40) | 10.500 (266.70) | 5.250 (133.35) | .205 (5.21) | 3 |

CONNECTOR DIMENSIONS CONTACT SPACING .100" (2.54mm)

Card Edge Connector Series 325, 340, 341, 342, 345, 391, 392, 395, 745

| DIMENSION | | | "C" | | | | | "D" | | "E" | | | | | | |
|--------------------------------------|-------|----------|---------|----------|----------|----------|----------|----------|-----------------|----------|---------|----------|-------------------|----------|---------------|----------|
| SERIES | 325 | | 340 | | 341, 391 | | 342, 392 | | 345, 395 745 | | 340 | | REST OF SERIES | | ALL SERIES | |
| Number of Contacts Single Dual | Inch | (mm) | Inch | (mm) | Inch | (mm) | Inch | (mm) | Inch | (mm) | Inch | (mm) | Inch | (mm) | Inch | (mm) |
| | 5 10 | .722 | (18.34) | .965 | (24.51) | .775 | (19.69) | .746 | (18.95) | .760 | (19.30) | .610 | (15.49) | .600 | (15.24) | .400 |
| 6 12 | .822 | (20.88) | 1.065 | (27.05) | .875 | (22.23) | .846 | (21.49) | .860 | (21.84) | .710 | (18.03) | .700 | (17.78) | .500 | (12.70) |
| 7 14 | .922 | (23.42) | 1.165 | (29.59) | .975 | (24.77) | .946 | (24.03) | .960 | (24.38) | .810 | (20.57) | .800 | (20.32) | .600 | (15.24) |
| 8 16 | 1.022 | (25.96) | 1.265 | (32.13) | 1.075 | (27.31) | 1.046 | (26.57) | 1.060 | (26.92) | .910 | (23.11) | .900 | (22.86) | .700 | (17.78) |
| 9 18 | 1.122 | (28.50) | 1.365 | (34.67) | 1.175 | (29.85) | 1.146 | (29.11) | 1.160 | (29.46) | 1.010 | (25.65) | 1.000 | (25.40) | .800 | (20.32) |
| 10 20 | 1.222 | (31.04) | 1.465 | (37.21) | 1.275 | (32.39) | 1.246 | (31.65) | 1.260 | (32.00) | 1.110 | (28.19) | 1.100 | (27.94) | .900 | (22.86) |
| 11 22 | 1.322 | (33.58) | 1.565 | (39.75) | 1.375 | (34.93) | 1.346 | (34.19) | 1.360 | (34.54) | 1.210 | (30.73) | 1.200 | (30.48) | 1.000 | (25.40) |
| 12 24 | 1.422 | (36.12) | 1.665 | (42.29) | 1.475 | (37.47) | 1.446 | (36.73) | 1.460 | (37.08) | 1.310 | (33.27) | 1.300 | (33.02) | 1.100 | (27.94) |
| 13 26 | 1.522 | (38.66) | 1.765 | (44.83) | 1.575 | (40.01) | 1.546 | (39.27) | 1.560 | (39.62) | 1.410 | (35.81) | 1.400 | (35.56) | 1.200 | (30.48) |
| 14 28 | 1.622 | (41.20) | 1.865 | (47.37) | 1.675 | (42.55) | 1.646 | (41.81) | 1.660 | (42.16) | 1.510 | (38.35) | 1.500 | (38.10) | 1.300 | (33.02) |
| 15 30 | 1.722 | (43.74) | 1.965 | (49.91) | 1.775 | (45.09) | 1.746 | (44.35) | 1.760 | (44.70) | 1.610 | (40.89) | 1.600 | (40.64) | 1.400 | (35.56) |
| 16 32 | 1.822 | (46.28) | 2.065 | (52.45) | 1.875 | (47.63) | 1.846 | (46.89) | 1.860 | (47.24) | 1.710 | (43.43) | 1.700 | (43.18) | 1.500 | (38.10) |
| 17 34 | 1.922 | (48.82) | 2.165 | (54.99) | 1.975 | (50.17) | 1.946 | (49.43) | 1.960 | (49.78) | 1.810 | (45.97) | 1.800 | (45.72) | 1.600 | (40.64) |
| 18 36 | 2.022 | (51.36) | 2.265 | (57.53) | 2.075 | (52.71) | 2.046 | (51.97) | 2.060 | (52.32) | 1.910 | (48.51) | 1.900 | (48.26) | 1.700 | (43.18) |
| 19 38 | 2.122 | (53.90) | 2.365 | (60.07) | 2.175 | (55.25) | 2.146 | (54.51) | 2.160 | (54.86) | 2.010 | (51.05) | 2.000 | (50.80) | 1.800 | (45.72) |
| 20 40 | 2.222 | (56.44) | 2.465 | (62.61) | 2.275 | (57.79) | 2.246 | (57.05) | 2.260 | (57.40) | 2.110 | (53.59) | 2.100 | (53.34) | 1.900 | (48.26) |
| 21 42 | 2.322 | (58.98) | 2.565 | (65.15) | 2.375 | (60.33) | 2.346 | (59.59) | 2.360 | (59.94) | 2.210 | (56.13) | 2.200 | (55.88) | 2.000 | (50.80) |
| 22 44 | 2.422 | (61.52) | 2.665 | (67.69) | 2.475 | (62.87) | 2.446 | (62.13) | 2.460 | (62.48) | 2.310 | (58.67) | 2.300 | (58.42) | 2.100 | (53.34) |
| 23 46 | 2.522 | (64.06) | 2.765 | (70.23) | 2.575 | (65.41) | 2.546 | (64.67) | 2.560 | (65.02) | 2.410 | (61.21) | 2.400 | (60.96) | 2.200 | (55.88) |
| 24 48 | 2.622 | (66.60) | 2.865 | (72.77) | 2.675 | (67.95) | 2.646 | (67.21) | 2.660 | (67.56) | 2.510 | (63.75) | 2.500 | (63.50) | 2.300 | (58.42) |
| 25 50 | 2.722 | (69.14) | 2.965 | (75.31) | 2.775 | (70.49) | 2.746 | (69.75) | 2.760 | (70.10) | 2.610 | (66.29) | 2.600 | (66.04) | 2.400 | (60.96) |
| 26 52 | 2.822 | (71.68) | 3.065 | (77.85) | 2.875 | (73.03) | 2.846 | (72.29) | 2.860 | (72.64) | 2.710 | (68.83) | 2.700 | (68.58) | 2.500 | (63.50) |
| 27 54 | 2.922 | (74.22) | 3.165 | (80.39) | 2.975 | (75.57) | 2.946 | (74.83) | 2.960 | (75.18) | 2.810 | (71.37) | 2.800 | (71.12) | 2.600 | (66.04) |
| 28 56 | 3.022 | (76.76) | 3.265 | (82.93) | 3.075 | (78.11) | 3.046 | (77.37) | 3.060 | (77.72) | 2.910 | (73.91) | 2.900 | (73.66) | 2.700 | (68.58) |
| 29 58 | 3.122 | (79.30) | 3.365 | (85.47) | 3.175 | (80.65) | 3.146 | (79.91) | 3.160 | (80.26) | 3.010 | (76.45) | 3.000 | (76.20) | 2.800 | (71.12) |
| 30 60 | 3.222 | (81.84) | 3.465 | (88.01) | 3.275 | (83.19) | 3.246 | (82.45) | 3.260 | (82.80) | 3.110 | (78.99) | 3.100 | (78.74) | 2.900 | (73.66) |
| 31 62 | 3.322 | (84.38) | 3.565 | (90.55) | 3.375 | (85.73) | 3.346 | (84.99) | 3.360 | (85.34) | 3.210 | (81.53) | 3.200 | (81.28) | 3.000 | (76.20) |
| 32 64 | 3.422 | (86.92) | 3.665 | (93.09) | 3.475 | (88.27) | 3.446 | (87.53) | 3.460 | (87.88) | 3.310 | (84.07) | 3.300 | (83.82) | 3.100 | (78.74) |
| 33 66 | 3.522 | (89.46) | 3.765 | (95.63) | 3.575 | (90.81) | 3.546 | (90.07) | 3.560 | (90.42) | 3.410 | (86.61) | 3.400 | (86.36) | 3.200 | (81.28) |
| 34 68 | 3.622 | (92.00) | 3.865 | (98.17) | 3.675 | (93.35) | 3.646 | (92.61) | 3.660 | (92.96) | 3.510 | (89.15) | 3.500 | (88.90) | 3.300 | (83.82) |
| 35 70 | 3.722 | (94.54) | 3.965 | (100.71) | 3.775 | (95.89) | 3.746 | (95.15) | 3.760 | (95.50) | 3.610 | (91.69) | 3.600 | (91.44) | 3.400 | (86.36) |
| 36 72 | 3.822 | (97.08) | 4.065 | (103.25) | 3.875 | (98.43) | 3.846 | (97.69) | 3.860 | (98.04) | 3.710 | (94.23) | 3.700 | (93.98) | 3.500 | (88.90) |
| 37 74 | 3.922 | (99.62) | 4.165 | (105.79) | 3.975 | (100.97) | 3.946 | (100.23) | 3.960 | (100.58) | 3.810 | (96.77) | 3.800 | (96.52) | 3.600 | (91.44) |
| 38 76 | 4.022 | (102.16) | 4.265 | (108.33) | 4.075 | (103.51) | 4.046 | (102.77) | 4.060 | (103.12) | 3.910 | (99.31) | 3.900 | (99.06) | 3.700 | (93.98) |
| 39 78 | 4.122 | (104.70) | 4.365 | (110.87) | 4.175 | (106.05) | 4.146 | (105.31) | 4.160 | (105.66) | 4.010 | (101.85) | 4.000 | (101.60) | 3.800 | (96.52) |
| 40 80 | 4.222 | (107.24) | 4.465 | (113.41) | 4.275 | (108.59) | 4.246 | (107.85) | 4.260 | (108.20) | 4.110 | (104.39) | 4.100 | (104.14) | 3.900 | (99.06) |
| 41 82 | 4.322 | (109.78) | 4.565 | (115.95) | 4.375 | (111.13) | 4.346 | (110.39) | 4.360 | (110.74) | 4.210 | (106.93) | 4.200 | (106.68) | 4.000 | (101.60) |
| 42 84 | 4.422 | (112.32) | 4.665 | (118.49) | 4.475 | (113.67) | 4.446 | (112.93) | 4.460 | (113.28) | 4.310 | (109.47) | 4.300 | (109.22) | 4.100 | (104.14) |
| 43 86 | 4.522 | (114.86) | 4.765 | (121.03) | 4.575 | (116.21) | 4.546 | (115.47) | 4.560 | (115.82) | 4.410 | (112.01) | 4.400 | (111.76) | 4.200 | (106.68) |
| 44 88 | 4.622 | (117.40) | 4.865 | (123.57) | 4.675 | (118.75) | 4.646 | (118.01) | 4.660 | (118.36) | 4.510 | (114.55) | 4.500 | (114.30) | 4.300 | (109.22) |
| 45 90 | 4.722 | (119.94) | 4.965 | (126.11) | 4.775 | (121.29) | 4.746 | (120.55) | 4.760 | (120.90) | 4.610 | (117.09) | 4.600 | (116.84) | 4.400 | (111.76) |
| 46 92 | 4.822 | (122.48) | 5.065 | (128.65) | 4.875 | (123.83) | 4.846 | (123.09) | 4.860 | (123.44) | 4.710 | (119.63) | 4.700 | (119.38) | 4.500 | (114.30) |
| 47 94 | 4.922 | (125.02) | 5.165 | (131.19) | 4.975 | (126.37) | 4.946 | (125.63) | 4.960 | (125.98) | 4.810 | (122.17) | 4.800 | (121.92) | 4.600 | (116.84) |
| 48 96 | 5.022 | (127.56) | 5.265 | (133.73) | 5.075 | (128.91) | 5.046 | (128.17) | 5.060 | (128.52) | 4.910 | (124.71) | 4.900 | (124.46) | 4.700 | (119.38) |
| 49 98 | 5.122 | (130.10) | 5.365 | (136.27) | 5.175 | (131.45) | 5.146 | (130.71) | 5.160 | (131.06) | 5.010 | (127.25) | 5.000 | (127.00) | 4.800 | (121.92) |
| 50 100 | 5.222 | (132.64) | 5.465 | (138.81) | 5.275 | (133.99) | 5.246 | (133.25) | 5.260 | (133.60) | 5.110 | (129.79) | 5.100 | (129.54) | 4.900 | (124.46) |
| 51 102 | 5.322 | (135.18) | 5.565 | (141.35) | 5.375 | (136.53) | 5.346 | (135.79) | 5.360 | (136.14) | 5.210 | (132.33) | 5.200 | (132.08) | 5.000 | (127.00) |
| 52 104 | 5.422 | (137.72) | 5.665 | (143.89) | 5.475 | (139.07) | 5.446 | (138.33) | 5.460 | (138.68) | 5.310 | (134.87) | 5.300 | (134.62) | 5.100 | (129.54) |
| 53 106 | 5.522 | (140.26) | 5.765 | (146.43) | 5.575 | (141.61) | 5.546 | (140.87) | 5.560 | (141.22) | 5.410 | (137.41) | 5.400 | (137.16) | 5.200 | (132.08) |
| 54 108 | 5.622 | (142.80) | 5.865 | (148.97) | 5.675 | (144.15) | 5.646 | (143.41) | 5.660 | (143.76) | 5.510 | (139.95) | 5.500 | (139.70) | 5.300 | (134.62) |
| 55 110 | 5.722 | (145.34) | 5.965 | (151.51) | 5.775 | (146.69) | 5.746 | (145.95) | 5.760 | (146.30) | 5.610 | (142.49) | 5.600 | (142.24) | 5.400 | (137.16) |
| 56 112 | 5.822 | (147.88) | 6.065 | (154.05) | 5.875 | (149.23) | 5.846 | (148.49) | 5.860 | (148.84) | 5.710 | (145.03) | 5.700 | (144.78) | 5.500 | (139.70) |
| 57 114 | 5.922 | (150.42) | 6.165 | (156.59) | 5.975 | (151.77) | 5.946 | (151.03) | 5.960 | (151.38) | 5.810 | (147.57) | 5.800 | (147.32) | 5.600 | (142.24) |
| 58 116 | 6.022 | (152.96) | 6.265 | (159.13) | 6.075 | (154.31) | 6.046 | (153.57) | 6.060 | (153.92) | 5.910 | (150.11) | 5.900 | (149.86) | 5.700 | (144.78) |
| 59 118 | 6.122 | (155.50) | 6.365 | (161.67) | 6.175 | (156.85) | 6.146 | (156.11) | 6.160 | (156.46) | 6.010 | (152.65) | 6.000 | (152.40) | 5.800 | (147.32) |
| 60 120 | 6.222 | (158.04) | 6.465 | (164.21) | 6.275 | (159.39) | 6.246 | (158.35) | 6.260 | (158.70) | 6.110 | (155.19) | 6.100 | (154.94) | 5.900 | (149.86) |
| 61 122 | 6.322 | (160.58) | | | | | | | 6.360 | (161.54) | | | 6.200 | (157.48) | 6.000 | (152.40) |
| 62 124 | | | | | | | | | 6.460 | (164.08) | | | 6.300 | (160.02) | 6.100 | (154.94) |
| 63 126 | | | | | | | | | 6.560 | (166.62) | | | 6.400 | (162.56) | 6.200 | (157.48) |
| 64 128 | | | | | | | | | 6.660 | (169.16) | | | 6.500 | (165.10) | 6.300 | (160.02) |
| 65 130 | | | | | | | | | 6.760 | (171.70) | | | 6.600 | (167.64) | 6.400 | (162.56) |
| 66 132 | | | | | | | | | 6.860 | (174.24) | | | 6.700 | (170.18) | 6.500 | (165.10) |
| 67 134 | | | | | | | | | 6.960 | (176.78) | | | 6.800 | (172.72) | 6.600 | (167.64) |
| 68 136 | | | | | | | | | 7.060 | (179.32) | | | 6.900 | (175.26) | 6.700 | (170.18) |
| 69 138 | | | | | | | | | 7.160 | (181.86) | | | 7.000 | (177.80) | 6.800 | (172.72) |
| 70 140 | | | | | | | | | 7.260 | (184.40) | | | 7.100 | (180.34) | 6.900 | (175.26) |
| 71 142 | | | | | | | | | 7.360 | (186.94) | | | 7.200 | (182.88) | 7.000 | (177.80) |
| 72 144 | | | | | | | | | 7.460 | (189.48) | | | 7.300 | (185.42) | 7.100 | (180.34) |
| 73 146 | | | | | | | | | 7.560 | (192.02) | | | 7.400 | (187.96) | 7.200 | (182.88) |
| 74 148 | | | | | | | | | 7.660 | (194.56) | | | 7.500 | (190.50) | 7.300 | (185.42) |
| 75 150 | | | | | | | | | 7.760 | (197.10) | | | 7.600 | (193.04) | 7.400 | (187.96) |

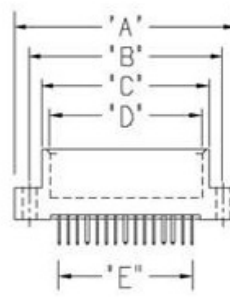

.156" (3.96mm) CONTACT SPACING CONNECTOR DIMENSIONS

303, 305, 306, 307, 315, 316, 317, 333, 336, 337, 355, 356, 357, 387, 737 Series Card Edge Connectors

| DIMENSION | | "A" | | | | "B" | | | | | | | | | |
|--------------------|-------------|-------|----------|-------|----------|-------|----------|----------------|----------|-------|----------|----------|----------|----------------|----------|
| SERIES | | 317 | | 333 | | 336 | | REST OF SERIES | | 317 | | 333, 336 | | REST OF SERIES | |
| Number of Contacts | Single Dual | Inch | (mm) | Inch | (mm) | Inch | (mm) | Inch | (mm) | Inch | (mm) | Inch | (mm) | Inch | (mm) |
| | | | | | | | | | | | | | | | |
| 6 | 12 | 1.830 | (46.48) | 1.784 | (45.31) | 1.857 | (47.17) | 1.842 | (46.79) | 1.539 | (39.09) | 1.534 | (38.96) | 1.532 | (38.91) |
| 7 | 14 | 1.986 | (50.44) | 1.940 | (49.28) | 2.013 | (51.13) | 1.998 | (50.75) | 1.695 | (43.05) | 1.690 | (42.93) | 1.688 | (42.88) |
| 8 | 16 | 2.142 | (54.41) | 2.096 | (53.24) | 2.169 | (55.09) | 2.154 | (54.71) | 1.851 | (47.02) | 1.846 | (46.89) | 1.844 | (46.84) |
| 9 | 18 | 2.298 | (58.37) | 2.252 | (57.20) | 2.325 | (59.06) | 2.310 | (58.67) | 2.007 | (50.98) | 2.002 | (50.85) | 2.000 | (50.80) |
| 10 | 20 | 2.454 | (62.33) | 2.408 | (61.16) | 2.481 | (63.02) | 2.466 | (62.64) | 2.163 | (54.94) | 2.158 | (54.81) | 2.156 | (54.76) |
| 11 | 22 | 2.610 | (66.29) | 2.564 | (65.13) | 2.637 | (66.98) | 2.622 | (66.60) | 2.319 | (58.90) | 2.314 | (58.78) | 2.312 | (58.72) |
| 12 | 24 | 2.766 | (70.26) | 2.720 | (69.09) | 2.793 | (70.94) | 2.778 | (70.56) | 2.475 | (62.87) | 2.470 | (62.74) | 2.468 | (62.69) |
| 13 | 26 | 2.922 | (74.22) | 2.876 | (73.05) | 2.949 | (74.90) | 2.934 | (74.52) | 2.631 | (66.83) | 2.626 | (66.70) | 2.624 | (66.65) |
| 14 | 28 | 3.078 | (78.18) | 3.032 | (77.01) | 3.105 | (78.87) | 3.090 | (78.49) | 2.787 | (70.79) | 2.782 | (70.66) | 2.780 | (70.61) |
| 15 | 30 | 3.234 | (82.14) | 3.188 | (80.98) | 3.261 | (82.83) | 3.246 | (82.45) | 2.943 | (74.75) | 2.938 | (74.63) | 2.936 | (74.57) |
| 16 | 32 | 3.390 | (86.11) | 3.344 | (84.94) | 3.417 | (86.79) | 3.402 | (86.41) | 3.099 | (78.71) | 3.094 | (78.59) | 3.092 | (78.54) |
| 17 | 34 | 3.546 | (90.07) | 3.500 | (88.90) | 3.573 | (90.75) | 3.558 | (90.37) | 3.255 | (82.68) | 3.250 | (82.55) | 3.248 | (82.50) |
| 18 | 36 | 3.702 | (94.03) | 3.656 | (92.86) | 3.729 | (94.72) | 3.714 | (94.34) | 3.411 | (86.64) | 3.406 | (86.51) | 3.404 | (86.46) |
| 19 | 38 | 3.858 | (97.99) | 3.812 | (96.82) | 3.885 | (98.68) | 3.870 | (98.30) | 3.567 | (90.60) | 3.562 | (90.47) | 3.560 | (90.42) |
| 20 | 40 | 4.014 | (101.96) | 3.968 | (100.79) | 4.041 | (102.64) | 4.026 | (102.26) | 3.723 | (94.56) | 3.718 | (94.44) | 3.716 | (94.39) |
| 21 | 42 | 4.170 | (105.92) | 4.124 | (104.75) | 4.197 | (106.60) | 4.182 | (106.22) | 3.879 | (98.53) | 3.874 | (98.40) | 3.872 | (98.35) |
| 22 | 44 | 4.326 | (109.88) | 4.280 | (108.71) | 4.353 | (110.57) | 4.338 | (110.19) | 4.035 | (102.49) | 4.030 | (102.36) | 4.028 | (102.31) |
| 23 | 46 | 4.482 | (113.84) | 4.436 | (112.67) | 4.509 | (114.53) | 4.494 | (114.15) | 4.191 | (106.45) | 4.186 | (106.32) | 4.184 | (106.27) |
| 24 | 48 | 4.638 | (117.81) | 4.592 | (116.64) | 4.665 | (118.49) | 4.650 | (118.11) | 4.347 | (110.41) | 4.342 | (110.29) | 4.340 | (110.24) |
| 25 | 50 | 4.794 | (121.77) | 4.748 | (120.60) | 4.821 | (122.45) | 4.806 | (122.07) | 4.503 | (114.38) | 4.498 | (114.25) | 4.496 | (114.20) |
| 26 | 52 | 4.950 | (125.73) | 4.904 | (124.56) | 4.977 | (126.42) | 4.962 | (126.03) | 4.659 | (118.34) | 4.654 | (118.21) | 4.652 | (118.16) |
| 27 | 54 | 5.106 | (129.69) | 5.060 | (128.52) | 5.133 | (130.38) | 5.118 | (130.00) | 4.815 | (122.30) | 4.810 | (122.17) | 4.808 | (122.12) |
| 28 | 56 | 5.262 | (133.65) | 5.216 | (132.49) | 5.289 | (134.34) | 5.274 | (133.96) | 4.971 | (126.26) | 4.966 | (126.14) | 4.964 | (126.09) |
| 29 | 58 | 5.418 | (137.62) | 5.372 | (136.45) | 5.445 | (138.30) | 5.430 | (137.92) | 5.127 | (130.23) | 5.122 | (130.10) | 5.120 | (130.05) |
| 30 | 60 | 5.574 | (141.58) | 5.528 | (140.41) | 5.601 | (142.27) | 5.586 | (141.88) | 5.283 | (134.19) | 5.278 | (134.06) | 5.276 | (134.01) |
| 31 | 62 | 5.730 | (145.54) | 5.684 | (144.37) | 5.757 | (146.23) | 5.742 | (145.85) | 5.439 | (138.15) | 5.434 | (138.02) | 5.432 | (137.97) |
| 32 | 64 | 5.886 | (149.50) | 5.840 | (148.34) | 5.913 | (150.19) | 5.898 | (149.81) | 5.595 | (142.11) | 5.590 | (141.99) | 5.588 | (141.94) |
| 33 | 66 | 6.042 | (153.47) | 5.996 | (152.30) | 6.069 | (154.15) | 6.054 | (153.77) | 5.751 | (146.08) | 5.746 | (145.95) | 5.744 | (145.90) |
| 34 | 68 | 6.198 | (157.43) | 6.152 | (156.26) | 6.225 | (158.12) | 6.210 | (157.73) | 5.907 | (150.04) | 5.902 | (149.91) | 5.900 | (149.86) |
| 35 | 70 | 6.354 | (161.39) | 6.308 | (160.22) | 6.381 | (162.08) | 6.366 | (161.70) | 6.063 | (154.00) | 6.058 | (153.87) | 6.056 | (153.82) |
| 36 | 72 | 6.510 | (165.35) | 6.464 | (164.19) | 6.537 | (166.04) | 6.522 | (165.66) | 6.219 | (157.96) | 6.214 | (157.84) | 6.212 | (157.78) |
| 37 | 74 | 6.666 | (169.32) | 6.620 | (168.15) | 6.693 | (170.00) | 6.678 | (169.62) | 6.375 | (161.93) | 6.370 | (161.80) | 6.368 | (161.75) |
| 38 | 76 | 6.822 | (173.28) | 6.776 | (172.11) | 6.849 | (173.96) | 6.834 | (173.58) | 6.531 | (165.89) | 6.526 | (165.76) | 6.524 | (165.71) |
| 39 | 78 | 6.978 | (177.24) | 6.932 | (176.07) | 7.005 | (177.93) | 6.990 | (177.55) | 6.687 | (169.85) | 6.682 | (169.72) | 6.680 | (169.67) |
| 40 | 80 | 7.134 | (181.20) | 7.088 | (180.04) | 7.161 | (181.89) | 7.146 | (181.51) | 6.843 | (173.81) | 6.838 | (173.69) | 6.836 | (173.63) |
| 41 | 82 | 7.290 | (185.17) | 7.244 | (184.00) | 7.317 | (185.85) | 7.302 | (185.47) | 6.999 | (177.77) | 6.994 | (177.65) | 6.992 | (177.60) |
| 42 | 84 | 7.446 | (189.13) | 7.400 | (187.96) | 7.473 | (189.81) | 7.458 | (189.43) | 7.155 | (181.74) | 7.150 | (181.61) | 7.148 | (181.56) |
| 43 | 86 | 7.602 | (193.09) | 7.556 | (191.92) | 7.629 | (193.78) | 7.614 | (193.40) | 7.311 | (185.70) | 7.306 | (185.57) | 7.304 | (185.52) |
| 44 | 88 | | | | | | | 7.770 | (197.36) | | | | | 7.460 | (189.48) |

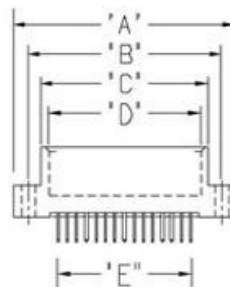

CONNECTOR DIMENSIONS CONTACT SPACING .156" (3.96mm)

Card Edge Connector Series 303, 305, 306, 307, 315, 316, 317, 333, 336, 337, 355, 356, 357, 387, 737

| DIMENSION | | "C" | | | | "D" | | | | "E" | | | | | |
|-----------------------------------|----|----------|----------|-------|----------|-------|----------|----------------|----------|----------|----------|----------------|----------|------------|----------|
| SERIES | | 303, 317 | | 333 | | 336 | | REST OF SERIES | | 315, 316 | | REST OF SERIES | | ALL SERIES | |
| Number of Contacts Single Dual | | Inch | (mm) | Inch | (mm) | Inch | (mm) | Inch | (mm) | Inch | (mm) | Inch | (mm) | Inch | (mm) |
| 6 | 12 | 1.220 | (30.99) | 1.261 | (32.03) | 1.216 | (30.89) | 1.246 | (31.65) | 1.080 | (27.43) | 1.100 | (27.94) | .780 | (19.81) |
| 7 | 14 | 1.376 | (34.95) | 1.417 | (35.99) | 1.372 | (34.85) | 1.402 | (35.61) | 1.236 | (31.39) | 1.256 | (31.90) | .936 | (23.77) |
| 8 | 16 | 1.532 | (38.91) | 1.573 | (39.95) | 1.528 | (38.81) | 1.558 | (39.57) | 1.392 | (35.36) | 1.412 | (35.86) | 1.092 | (27.74) |
| 9 | 18 | 1.688 | (42.88) | 1.729 | (43.92) | 1.684 | (42.77) | 1.714 | (43.54) | 1.548 | (39.32) | 1.568 | (39.83) | 1.248 | (31.70) |
| 10 | 20 | 1.844 | (46.84) | 1.885 | (47.88) | 1.840 | (46.74) | 1.870 | (47.50) | 1.704 | (43.28) | 1.724 | (43.79) | 1.404 | (35.66) |
| 11 | 22 | 2.000 | (50.80) | 2.041 | (51.84) | 1.996 | (50.70) | 2.026 | (51.46) | 1.860 | (47.24) | 1.880 | (47.75) | 1.560 | (39.62) |
| 12 | 24 | 2.156 | (54.76) | 2.197 | (55.80) | 2.152 | (54.66) | 2.182 | (55.42) | 2.016 | (51.21) | 2.036 | (51.71) | 1.716 | (43.59) |
| 13 | 26 | 2.312 | (58.72) | 2.353 | (59.77) | 2.308 | (58.62) | 2.338 | (59.39) | 2.172 | (55.17) | 2.192 | (55.68) | 1.872 | (47.55) |
| 14 | 28 | 2.468 | (62.69) | 2.509 | (63.73) | 2.464 | (62.59) | 2.494 | (63.35) | 2.328 | (59.13) | 2.348 | (59.64) | 2.028 | (51.51) |
| 15 | 30 | 2.624 | (66.65) | 2.665 | (67.69) | 2.620 | (66.55) | 2.650 | (67.31) | 2.484 | (63.09) | 2.504 | (63.60) | 2.184 | (55.47) |
| 16 | 32 | 2.780 | (70.61) | 2.821 | (71.65) | 2.776 | (70.51) | 2.806 | (71.27) | 2.640 | (67.06) | 2.660 | (67.56) | 2.340 | (59.44) |
| 17 | 34 | 2.936 | (74.57) | 2.977 | (75.62) | 2.932 | (74.47) | 2.962 | (75.23) | 2.796 | (71.02) | 2.816 | (71.53) | 2.496 | (63.40) |
| 18 | 36 | 3.092 | (78.54) | 3.133 | (79.58) | 3.088 | (78.44) | 3.118 | (79.20) | 2.952 | (74.98) | 2.972 | (75.49) | 2.652 | (67.36) |
| 19 | 38 | 3.248 | (82.50) | 3.289 | (83.54) | 3.244 | (82.40) | 3.274 | (83.16) | 3.108 | (78.94) | 3.128 | (79.45) | 2.808 | (71.32) |
| 20 | 40 | 3.404 | (86.46) | 3.445 | (87.50) | 3.400 | (86.36) | 3.430 | (87.12) | 3.264 | (82.91) | 3.284 | (83.41) | 2.964 | (75.29) |
| 21 | 42 | 3.560 | (90.42) | 3.601 | (91.47) | 3.556 | (90.32) | 3.586 | (91.08) | 3.420 | (86.87) | 3.440 | (87.38) | 3.120 | (79.25) |
| 22 | 44 | 3.716 | (94.39) | 3.757 | (95.43) | 3.712 | (94.28) | 3.742 | (95.05) | 3.576 | (90.83) | 3.596 | (91.34) | 3.276 | (83.21) |
| 23 | 46 | 3.872 | (98.35) | 3.913 | (99.39) | 3.868 | (98.25) | 3.898 | (99.01) | 3.732 | (94.79) | 3.752 | (95.30) | 3.432 | (87.17) |
| 24 | 48 | 4.028 | (102.31) | 4.069 | (103.35) | 4.024 | (102.21) | 4.054 | (102.97) | 3.888 | (98.76) | 3.908 | (99.26) | 3.588 | (91.14) |
| 25 | 50 | 4.184 | (106.27) | 4.225 | (107.32) | 4.180 | (106.17) | 4.210 | (106.93) | 4.044 | (102.72) | 4.064 | (103.23) | 3.744 | (95.10) |
| 26 | 52 | 4.340 | (110.24) | 4.381 | (111.28) | 4.336 | (110.13) | 4.366 | (110.90) | 4.200 | (106.68) | 4.220 | (107.19) | 3.900 | (99.06) |
| 27 | 54 | 4.496 | (114.20) | 4.537 | (115.24) | 4.492 | (114.10) | 4.522 | (114.86) | 4.356 | (110.64) | 4.376 | (111.15) | 4.056 | (103.02) |
| 28 | 56 | 4.652 | (118.16) | 4.693 | (119.20) | 4.648 | (118.06) | 4.678 | (118.82) | 4.512 | (114.60) | 4.532 | (115.11) | 4.212 | (106.98) |
| 29 | 58 | 4.808 | (122.12) | 4.849 | (123.16) | 4.804 | (122.02) | 4.834 | (122.78) | 4.668 | (118.57) | 4.688 | (119.08) | 4.368 | (110.95) |
| 30 | 60 | 4.964 | (126.09) | 5.005 | (127.13) | 4.960 | (125.98) | 4.990 | (126.75) | 4.824 | (122.53) | 4.844 | (123.04) | 4.524 | (114.91) |
| 31 | 62 | 5.120 | (130.05) | 5.161 | (131.09) | 5.116 | (129.95) | 5.146 | (130.71) | 4.980 | (126.49) | 5.000 | (127.00) | 4.680 | (118.87) |
| 32 | 64 | 5.276 | (134.01) | 5.317 | (135.05) | 5.272 | (133.91) | 5.302 | (134.67) | 5.136 | (130.45) | 5.156 | (130.96) | 4.836 | (122.83) |
| 33 | 66 | 5.432 | (137.97) | 5.473 | (139.01) | 5.428 | (137.87) | 5.458 | (138.63) | 5.292 | (134.42) | 5.312 | (134.92) | 4.992 | (126.80) |
| 34 | 68 | 5.588 | (141.94) | 5.629 | (142.98) | 5.584 | (141.83) | 5.614 | (142.60) | 5.448 | (138.38) | 5.468 | (138.89) | 5.148 | (130.76) |
| 35 | 70 | 5.744 | (145.90) | 5.785 | (146.94) | 5.740 | (145.80) | 5.770 | (146.56) | 5.604 | (142.34) | 5.624 | (142.85) | 5.304 | (134.72) |
| 36 | 72 | 5.900 | (149.86) | 5.941 | (150.90) | 5.896 | (149.76) | 5.926 | (150.52) | 5.760 | (146.30) | 5.780 | (146.81) | 5.460 | (138.68) |
| 37 | 74 | 6.056 | (153.82) | 6.097 | (154.86) | 6.052 | (153.72) | 6.082 | (154.48) | 5.916 | (150.27) | 5.936 | (150.77) | 5.616 | (142.65) |
| 38 | 76 | 6.212 | (157.78) | 6.253 | (158.83) | 6.208 | (157.68) | 6.238 | (158.45) | 6.072 | (154.23) | 6.092 | (154.74) | 5.772 | (146.61) |
| 39 | 78 | 6.368 | (161.75) | 6.409 | (162.79) | 6.364 | (161.65) | 6.394 | (162.41) | 6.228 | (158.19) | 6.248 | (158.70) | 5.928 | (150.57) |
| 40 | 80 | 6.524 | (165.71) | 6.565 | (166.75) | 6.520 | (165.61) | 6.550 | (166.37) | 6.384 | (162.15) | 6.404 | (162.66) | 6.084 | (154.53) |
| 41 | 82 | 6.680 | (169.67) | 6.721 | (170.71) | 6.676 | (169.57) | 6.706 | (170.33) | 6.540 | (166.12) | 6.560 | (166.62) | 6.240 | (158.50) |
| 42 | 84 | 6.836 | (173.63) | 6.877 | (174.68) | 6.832 | (173.53) | 6.862 | (174.29) | 6.696 | (170.08) | 6.716 | (170.59) | 6.396 | (162.46) |
| 43 | 86 | 6.992 | (177.60) | 7.033 | (178.64) | 6.988 | (177.50) | 7.018 | (178.26) | 6.852 | (174.04) | 6.872 | (174.55) | 6.552 | (166.42) |
| 44 | 88 | | | | | | | 7.174 | (182.22) | | | 7.028 | (178.51) | 6.708 | (170.38) |

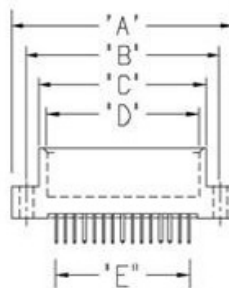

.125" (3.18mm) CONTACT SPACING CONNECTOR DIMENSIONS

346, 396, 746 Series Card Edge Connectors

| DIMENSION | | "A" | | "B" | | "C" | | "D" | | "E" | |
|------------------------------|------|----------|----------|----------|----------|------------|----------|------------|----------|------------|----------|
| SERIES | | 346, 396 | | 346, 396 | | ALL SERIES | | ALL SERIES | | ALL SERIES | |
| Number of Contacts Single | Dual | Inch | (mm) | Inch | (mm) | Inch | (mm) | Inch | (mm) | Inch | (mm) |
| | | 5 | 10 | 1.435 | (36.45) | 1.170 | (29.72) | .910 | (23.11) | .750 | (19.05) |
| 6 | 12 | 1.560 | (39.62) | 1.295 | (32.89) | 1.035 | (26.29) | .875 | (22.23) | .625 | (15.88) |
| 7 | 14 | 1.685 | (42.80) | 1.420 | (36.07) | 1.160 | (29.46) | 1.000 | (25.40) | .750 | (19.05) |
| 8 | 16 | 1.810 | (45.97) | 1.545 | (39.24) | 1.285 | (32.64) | 1.125 | (28.58) | .875 | (22.23) |
| 9 | 18 | 1.935 | (49.15) | 1.670 | (42.42) | 1.410 | (35.81) | 1.250 | (31.75) | 1.000 | (25.40) |
| 10 | 20 | 2.060 | (52.32) | 1.795 | (45.59) | 1.535 | (38.99) | 1.375 | (34.93) | 1.125 | (28.58) |
| 11 | 22 | 2.185 | (55.50) | 1.920 | (48.77) | 1.660 | (42.16) | 1.500 | (38.10) | 1.250 | (31.75) |
| 12 | 24 | 2.310 | (58.67) | 2.045 | (51.94) | 1.785 | (45.34) | 1.625 | (41.28) | 1.375 | (34.93) |
| 13 | 26 | 2.435 | (61.85) | 2.170 | (55.12) | 1.910 | (48.51) | 1.750 | (44.45) | 1.500 | (38.10) |
| 14 | 28 | 2.560 | (65.02) | 2.295 | (58.29) | 2.035 | (51.69) | 1.875 | (47.63) | 1.625 | (41.28) |
| 15 | 30 | 2.685 | (68.20) | 2.420 | (61.47) | 2.160 | (54.86) | 2.000 | (50.80) | 1.750 | (44.45) |
| 16 | 32 | 2.810 | (71.37) | 2.545 | (64.64) | 2.285 | (58.04) | 2.125 | (53.98) | 1.875 | (47.63) |
| 17 | 34 | 2.935 | (74.55) | 2.670 | (67.82) | 2.410 | (61.21) | 2.250 | (57.15) | 2.000 | (50.80) |
| 18 | 36 | 3.060 | (77.72) | 2.795 | (70.99) | 2.535 | (64.39) | 2.375 | (60.33) | 2.125 | (53.98) |
| 19 | 38 | 3.185 | (80.90) | 2.920 | (74.17) | 2.660 | (67.56) | 2.500 | (63.50) | 2.250 | (57.15) |
| 20 | 40 | 3.310 | (84.07) | 3.045 | (77.34) | 2.785 | (70.74) | 2.625 | (66.68) | 2.375 | (60.33) |
| 21 | 42 | 3.435 | (87.25) | 3.170 | (80.52) | 2.910 | (73.91) | 2.750 | (69.85) | 2.500 | (63.50) |
| 22 | 44 | 3.560 | (90.42) | 3.295 | (83.69) | 3.035 | (77.09) | 2.875 | (73.03) | 2.625 | (66.68) |
| 23 | 46 | 3.685 | (93.60) | 3.420 | (86.87) | 3.160 | (80.26) | 3.000 | (76.20) | 2.750 | (69.85) |
| 24 | 48 | 3.810 | (96.77) | 3.545 | (90.04) | 3.285 | (83.44) | 3.125 | (79.38) | 2.875 | (73.03) |
| 25 | 50 | 3.935 | (99.95) | 3.670 | (93.22) | 3.410 | (86.61) | 3.250 | (82.55) | 3.000 | (76.20) |
| 26 | 52 | 4.060 | (103.12) | 3.795 | (96.39) | 3.535 | (89.79) | 3.375 | (85.73) | 3.125 | (79.38) |
| 27 | 54 | 4.185 | (106.30) | 3.920 | (99.57) | 3.660 | (92.96) | 3.500 | (88.90) | 3.250 | (82.55) |
| 28 | 56 | 4.310 | (109.47) | 4.045 | (102.74) | 3.785 | (96.14) | 3.625 | (92.08) | 3.375 | (85.73) |
| 29 | 58 | 4.435 | (112.65) | 4.170 | (105.92) | 3.910 | (99.31) | 3.750 | (95.25) | 3.500 | (88.90) |
| 30 | 60 | 4.560 | (115.82) | 4.295 | (109.09) | 4.035 | (102.49) | 3.875 | (98.43) | 3.625 | (92.08) |
| 31 | 62 | 4.685 | (119.00) | 4.420 | (112.27) | 4.160 | (105.66) | 4.000 | (101.60) | 3.750 | (95.25) |
| 32 | 64 | 4.810 | (122.17) | 4.545 | (115.44) | 4.285 | (108.84) | 4.125 | (104.78) | 3.875 | (98.43) |
| 33 | 66 | 4.935 | (125.35) | 4.670 | (118.62) | 4.410 | (112.01) | 4.250 | (107.95) | 4.000 | (101.60) |
| 34 | 68 | 5.060 | (128.52) | 4.795 | (121.79) | 4.535 | (115.19) | 4.375 | (111.13) | 4.125 | (104.78) |
| 35 | 70 | 5.185 | (131.70) | 4.920 | (124.97) | 4.660 | (118.36) | 4.500 | (114.30) | 4.250 | (107.95) |
| 36 | 72 | 5.310 | (134.87) | 5.045 | (128.14) | 4.785 | (121.54) | 4.625 | (117.48) | 4.375 | (111.13) |
| 37 | 74 | 5.435 | (138.05) | 5.170 | (131.32) | 4.910 | (124.71) | 4.750 | (120.65) | 4.500 | (114.30) |
| 38 | 76 | 5.560 | (141.22) | 5.295 | (134.49) | 5.035 | (127.89) | 4.875 | (123.83) | 4.625 | (117.48) |
| 39 | 78 | 5.685 | (144.40) | 5.420 | (137.67) | 5.160 | (131.06) | 5.000 | (127.00) | 4.750 | (120.65) |
| 40 | 80 | 5.810 | (147.57) | 5.545 | (140.84) | 5.285 | (134.24) | 5.125 | (130.18) | 4.875 | (123.83) |
| 41 | 82 | 5.935 | (150.75) | 5.670 | (144.02) | 5.410 | (137.41) | 5.250 | (133.35) | 5.000 | (127.00) |
| 42 | 84 | 6.060 | (153.92) | 5.795 | (147.19) | 5.535 | (140.59) | 5.375 | (136.53) | 5.125 | (130.18) |
| 43 | 86 | 6.185 | (157.10) | 5.920 | (150.37) | 5.660 | (143.76) | 5.500 | (139.70) | 5.250 | (133.35) |
| 44 | 88 | 6.310 | (160.27) | 6.045 | (153.54) | 5.785 | (146.94) | 5.625 | (142.88) | 5.375 | (136.53) |
| 45 | 90 | 6.435 | (163.45) | 6.170 | (156.72) | 5.910 | (150.11) | 5.750 | (146.05) | 5.500 | (139.70) |
| 46 | 92 | 6.560 | (166.62) | 6.295 | (159.89) | 6.035 | (153.29) | 5.875 | (149.23) | 5.625 | (142.88) |
| 47 | 94 | 6.685 | (169.80) | 6.420 | (163.07) | 6.160 | (156.46) | 6.000 | (152.40) | 5.750 | (146.05) |
| 48 | 96 | 6.810 | (172.97) | 6.545 | (166.24) | 6.285 | (159.64) | 6.125 | (155.58) | 5.875 | (149.23) |
| 49 | 98 | 6.935 | (176.15) | 6.670 | (169.42) | 6.410 | (162.81) | 6.250 | (158.75) | 6.000 | (152.40) |
| 50 | 100 | 7.060 | (179.32) | 6.795 | (172.59) | 6.535 | (165.99) | 6.375 | (161.93) | 6.125 | (155.58) |
| 51 | 102 | | | | | 6.660 | (169.16) | 6.500 | (165.10) | 6.250 | (158.75) |
| 52 | 104 | | | | | 6.785 | (172.34) | 6.625 | (168.28) | 6.375 | (161.93) |
| 53 | 106 | | | | | 6.910 | (175.51) | 6.750 | (171.45) | 6.500 | (165.10) |
| 54 | 108 | | | | | 7.035 | (178.69) | 6.875 | (174.63) | 6.625 | (168.28) |
| 55 | 110 | | | | | 7.160 | (181.86) | 7.000 | (177.80) | 6.750 | (171.45) |
| 56 | 112 | | | | | 7.285 | (185.04) | 7.125 | (180.98) | 6.875 | (174.63) |
| 57 | 114 | | | | | 7.410 | (188.21) | 7.250 | (184.15) | 7.000 | (177.80) |
| 58 | 116 | | | | | 7.535 | (191.39) | 7.375 | (187.33) | 7.125 | (180.98) |
| 59 | 118 | | | | | 7.660 | (194.56) | 7.500 | (190.50) | 7.250 | (184.15) |
| 60 | 120 | | | | | 7.785 | (197.74) | 7.625 | (193.68) | 7.375 | (187.33) |

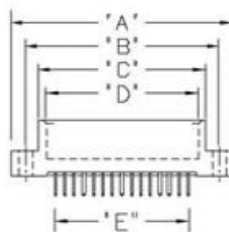

ADDITIONAL CONNECTOR SERIES

The following list of card edge connector series are no longer standard catalogue items, however they are not obsolete. Any orders received by Edac for a previously purchased item included within this list will be acknowledged.

Any new item inquiries should be made using the revised series number as indicated below. Please note that the conversion of special variation connector part numbers to the revised series should only be done in consultation with Edac Inc.

205 Series

Refer to 355 Series on page 31. For example, part number 205-030-521-202 is revised to 355-030-521-202.

206 Series

Refer to 356 Series on page 33. For example, part number 206-015-400-178 is revised to 356-015-400-178.

207 Series

Refer to 357 Series on page 35. For example, part number 207-020-555-202 is revised to 357-020-555-202.

237 Series

Refer to 387 Series on page 37. For example, part number 237-086-521-201 is revised to 387-086-521-201.

241 Series

Refer to 391 Series on page 19. For example, part number 241-030-520-201 is revised to 391-030-520-201.

245 Series

Refer to 395 Series on page 17. For example, part number 245-062-520-201 is revised to 395-062-520-201.

246 Series

Refer to 396 Series on page 29. For example, part number 246-070-540-201 is revised to 396-070-540-201.

308 Series

Refer to 357 Series on page 35. For example, part number 308-036-400-202 is revised to 357-036-400-202.

324 Series

Refer to 307 Series on page 35. For example, part number 324-036-520-268 is revised to 307-036-520-268.

330 Series

Refer to 307 Series on page 35. For example, part number 330-030-500-278 is revised to 307-030-500-278.

334 Series

Refer to 384 Series on page 58. For example, part number 334-018-525-102 is revised to 384-018-525-102. Insulator colour is revised from green to black.

399 Series

Refer to 349 Series on page 57. For example, part number 399-052-541-804 is revised to 349-052-541-804. Insulator colour is revised from black to green.



345 SERIES CONTACT EJECTION TOOL

- Part Number 345-280-200
- For Removal of Contacts in 325, 327, 333, 337, 340, 342, 345, 346, 379, 392, 395, 395-AT and 396 Series Connectors
- May also be Used for Removal of P.C. Tail Contacts in 336 and 349 Series
- Provides Easy Positive Ejection without Damage to the Insulator
- For Compliant Pin Connector Usage, See Page 6 .

100 SERIES CONTACTS FOR P.C. BOARD

.100" (2.54mm) & .200" (5.08mm) Contact Spacing

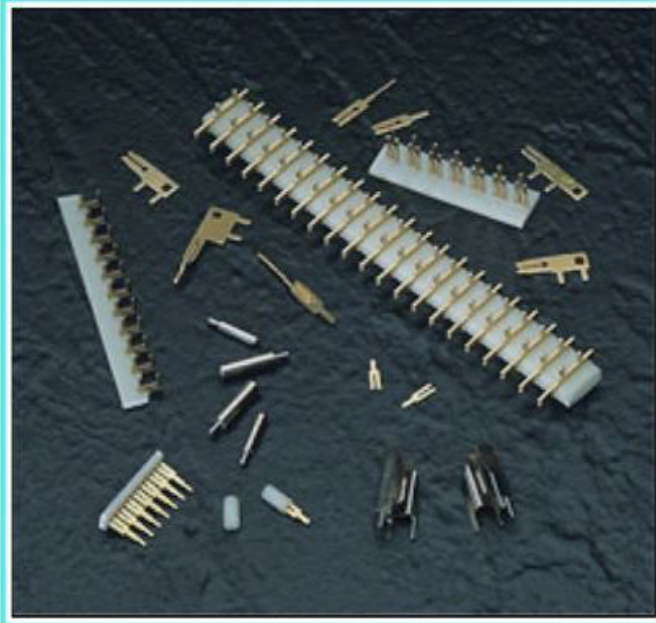

100 SERIES LOOSE CONTACTS

Example Part Number **100 - 290 - 208**



| Contact Code ^{1,2,3,4} | Silhouette | Tail Length "G" |
|---------------------------------|------------|-----------------|
| 201 | | .122 (3.10) |
| 202 | | .122 (3.10) |
| 208 | | .108 (2.74) |
| 210 | | .122 (3.10) |
| 250 | | .122 (3.10) |
| 251 | | .375 (9.53) |
| 252 | | .188 (4.78) |
| 253 | | .110 (2.79) |
| 258 | | .497 (12.62) |
| 450 | | .182 (4.62) |

103/105/106 SERIES CONTACTS ON STRIPS

Example Part Number **103 - 060 - 252 - 100**

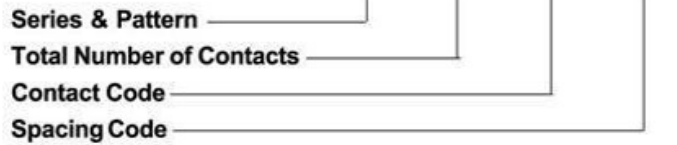

| Series and Pattern ^{5,6} | Pattern Description |
|-----------------------------------|---------------------|
| 103 | — — — — Horizontal |
| 105 | Vertical |
| 106 | / / / / /45 Degree |

| Total Number of Contacts ⁷ | Contact Spacing |
|---------------------------------------|-----------------|
| 002,003,...060 | .200 (5.08) |
| 002,003,...120 | .100 (2.54) |

| Contact Code ^{1,2,4} | Pattern | Contact Spacing |
|-------------------------------|------------|----------------------------|
| 201, 202, 203, 204 | 105 | .200 (5.08) |
| 208 | 105 | .100 (2.54) or .200 (5.08) |
| 250, 251, 450 | 103 or 106 | .200 (5.08) |
| 252 or 253 | 103 or 106 | .100 (2.54) or .200 (5.08) |

| Spacing Code | Contact Spacing |
|--------------|-----------------|
| 100 | .100 (2.54) |
| 200 | .200 (5.08) |

Ordering Code Notes

- Contact codes 208, 252 and 253 are rated for 5 Amperes current. All others contacts are rated for 10 Amperes.
- Contact codes 208, 252 and 253 will mate together, but not with the other contacts listed.
- Contact codes 210 and 258 are available loose only.
- Contact code 450 is designed for .125 (3.18) thick circuit boards. All other contacts are designed for .062 (1.57) thick boards.
- Pattern schematics are views toward the tip of the contact tails.
- Consult with Edac regarding double row staggered patterns for contact codes 250, 251, or 450. Available with up to 60 contacts per row, these patterns have .125 (3.18) row spacing for use on mother boards that mate with upper and lower tier daughter board contacts.
- All strip lengths up to 60 or 120 contacts (as determined by spacing and pattern) are available upon request.

FEATURES

- .100 (2.54) or .200 (5.08) Contact Spacing for Contacts on Strips. Other Spacings Accommodated with Loose Contacts
- Assemble onto .062 (1.57) or .125 (3.18) Nominal Thickness P.C. Board by Staking and/or Soldering of Contact Tails
- Edacon Hermaphroditic Contact Mating Design
- Card Guides, Guide Pins, Guide Sockets and Polarizing Sleeves to Ensure Correct Alignment and Mating are Available
- Handling and Assembly Simplified with Contacts on Strips
- Designed to Mate with 100 Series Contacts in Parallel or Perpendicular Board Configurations

SPECIFICATIONS

- Contact Material: Copper Alloy
- Contact Plating: Gold over Nickel for Entire Contact
- Current Rating: 5 or 10 Amperes (See Ordering Code Notes)
- Contact Resistance: 10 Milliohms Maximum
- Insertion and Withdrawal Force: 2 to 16 oz (0.56 to 4.45 N) per Contact

CONTACTS FOR P.C. BOARD SERIES 100

Contact Spacing .100" (2.54mm) & .200" (5.08mm)

PARALLEL P.C. BOARDS .200 (5.08) CONTACT SPACING

CONTACT CODES 250, 251, 258, OR 450
.062 (1.57) OR .125 (3.18) NOMINAL THICKNESS BOARDS

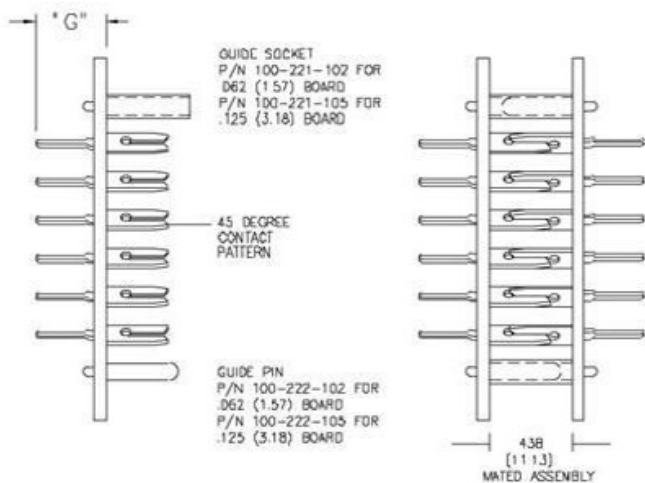

MOTHER BOARD - CONTACT CODES 250, 251, 258 OR 450
- .062 (1.57) OR .125 (3.18) NOMINAL THICKNESS BOARDS

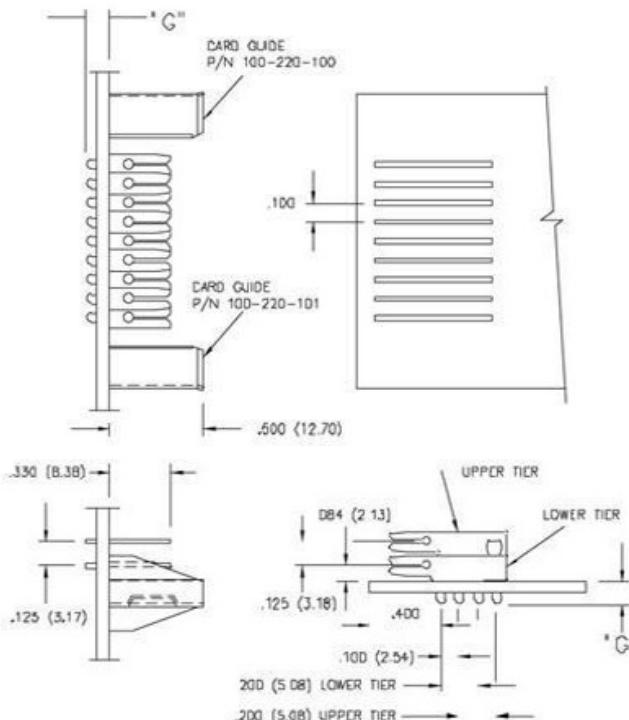

PARALLEL P.C. BOARDS .100 (2.54) OR .200 (5.08) CONTACT SPACING

CONTACT CODES 252 OR 253
.062 (1.57) OR .125 (3.18) NOMINAL THICKNESS BOARDS

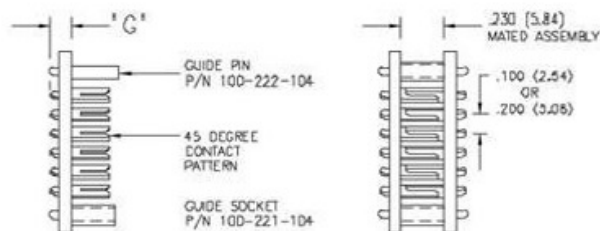

MOTHER/DAUGHTER BOARDS .100 (2.54) OR .200 (5.08) CONTACT SPACING

MOTHER BOARD - CONTACT CODES 252 OR 253
DAUGHTER BOARD - CONTACT CODE 208
- .062 (1.57) NOMINAL THICKNESS BOARDS

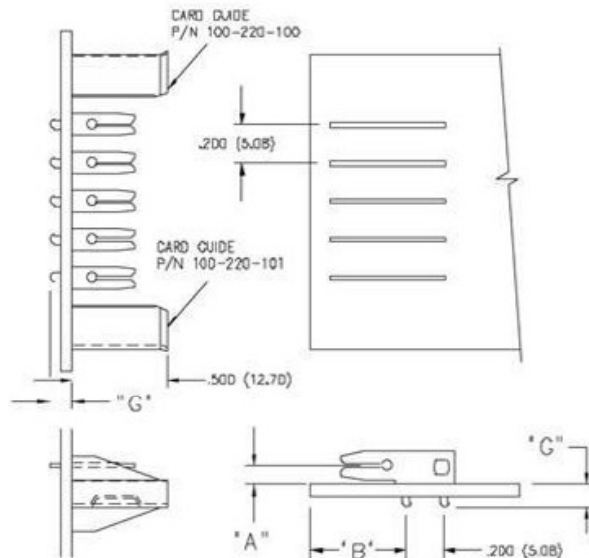
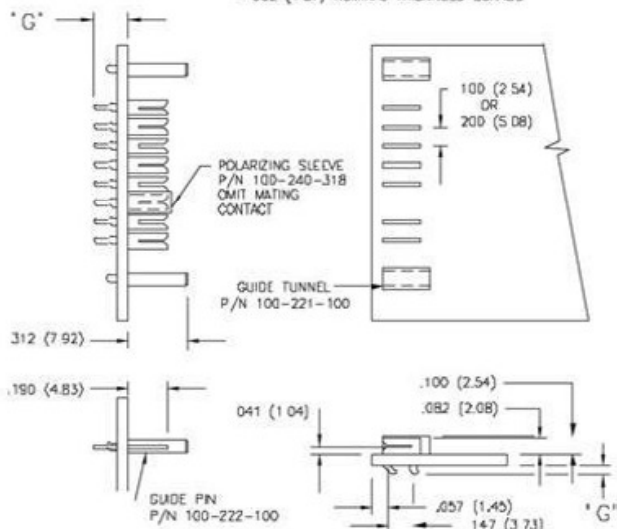

| CONTACT CODE | "A" | "B" |
|--------------|-------------|--------------|
| 201 | .209 (5.31) | .500 (12.70) |
| 202, 203 | .084 (2.13) | .400 (10.16) |
| 204 | .096 (2.44) | .450 (11.43) |
| 210 | .099 (2.51) | .200 (5.08) |

421/422/423 SERIES METAL TO METAL (TWO PIECE) CONNECTOR

Plug

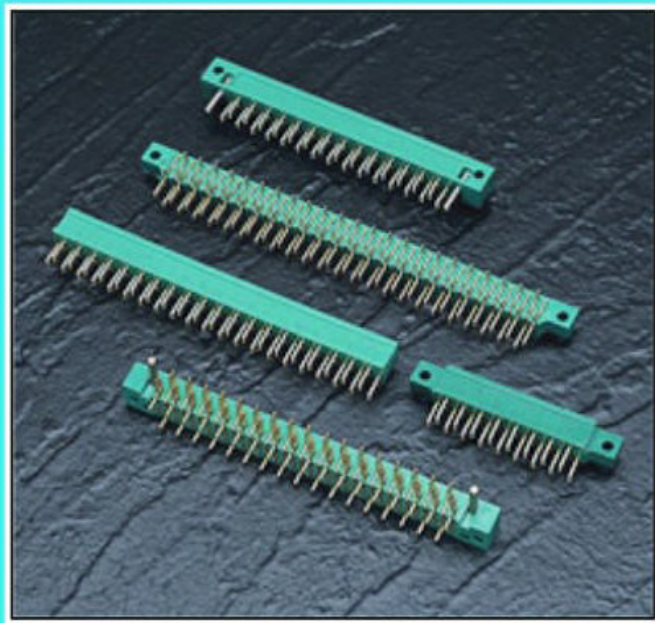

421/422/423 SERIES ORDERING CODE

Example Part Number **423 - 041 - 520 - 102**

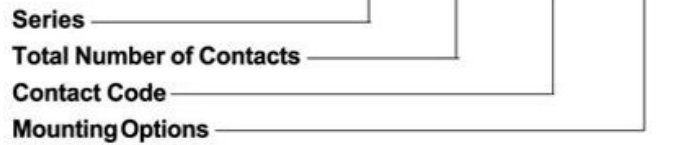

| Series | Insulator Mounting Option |
|--------|--|
| 421 | .128 (3.25) Dia. Mounting Holes |
| 422 | No Mounting Lugs |
| 423 | .128 (3.25) Dia. Mounting Holes and Guide Pins per MIL-C-21097 |

Total Number of Contacts
017, 023, 029, 035, 041 or 047

| Contact Code | Description & Tail Size | Tail Length "G" |
|--------------|-------------------------------------|-----------------|
| 520 | P.C. Tail .044 x .025 (1.12 x 0.64) | .122 (3.10) |
| 521 | P.C. Tail .044 x .025 (1.12 x 0.64) | .153 (3.89) |

| Mounting Options | Use Code with Series |
|------------------|----------------------|
| 100 | 422 Series |
| 102 | 421 or 423 Series |

FEATURES

- .200 (5.08) Contact Spacing x .300 (7.62) Row Spacing with Staggered Grid
- Mounts onto .062 (1.57) or .093 (2.36) Nominal Thickness P.C. Board by Soldering and/or Staking of P.C. Tails
- Edacon Hermaphroditic Contact Mating Design
- Mounting Hole and Guide Pin Options
- 421 Series Designed to Mate with Non-Card Guide Versions of 408 or 415 Series, 422 Series Designed to Mate with Card Guide Versions of 408 or 415 Series, 423 Series Designed to Mate with 424 or 438 Series

SPECIFICATIONS

- ◆ Insulator Material: Polyphenylene Sulphide, UL 94V-0, Colour: Green
- ◆ Contact Material: Copper Alloy
- ◆ Contact Plating: Gold over Nickel for Entire Contact
- ◆ Current Rating: 10 Amperes
- ◆ Contact Resistance: 10 Milliohms Maximum
- ◆ Dielectric Withstanding Voltage: 2000 V AC rms at Sea Level
- ◆ Insulation Resistance: 5000 Megohms Minimum
- ◆ Operating Temperature: -65 to +125 Degrees C
- ◆ Insertion and Withdrawal Force: 2 to 16 oz (0.56 to 4.45 N) per Contact Position

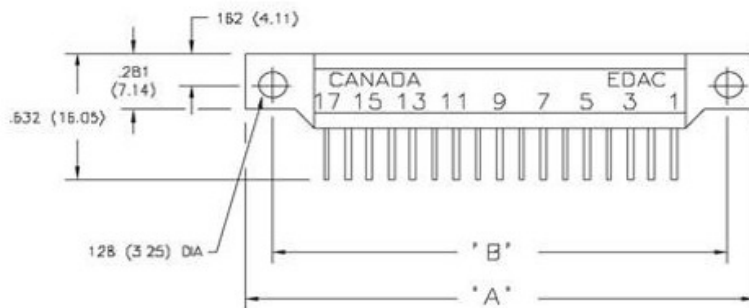

421 SERIES CONNECTOR

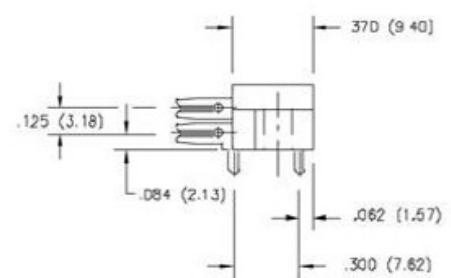
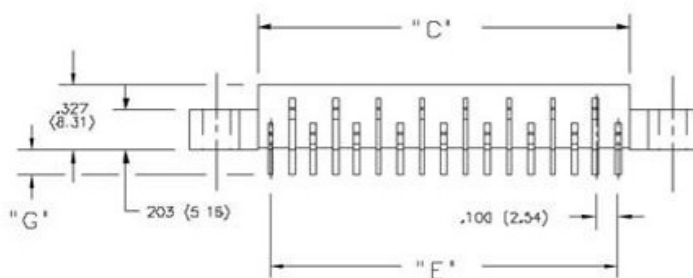

METAL TO METAL (TWO PIECE) CONNECTOR SERIES 421/422/423

Plug

422 SERIES CONNECTOR

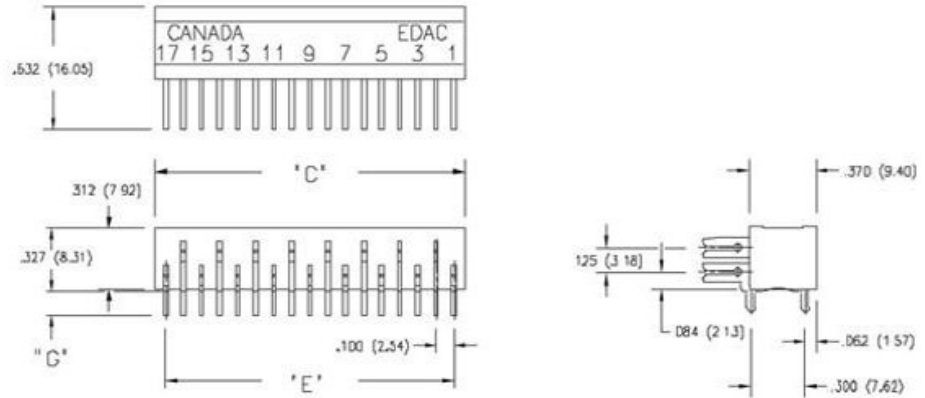

423 SERIES CONNECTOR

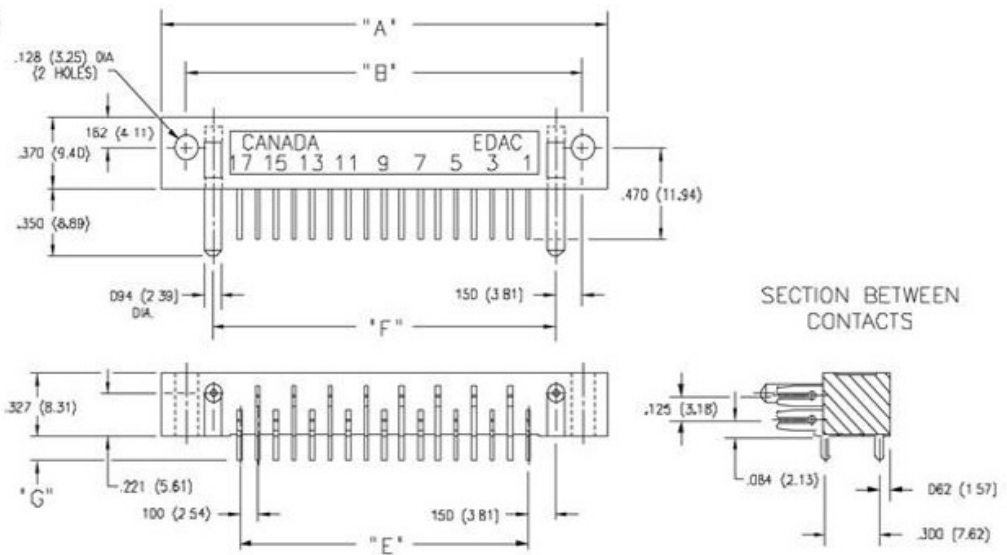

CONNECTOR MOUNTING PATTERN

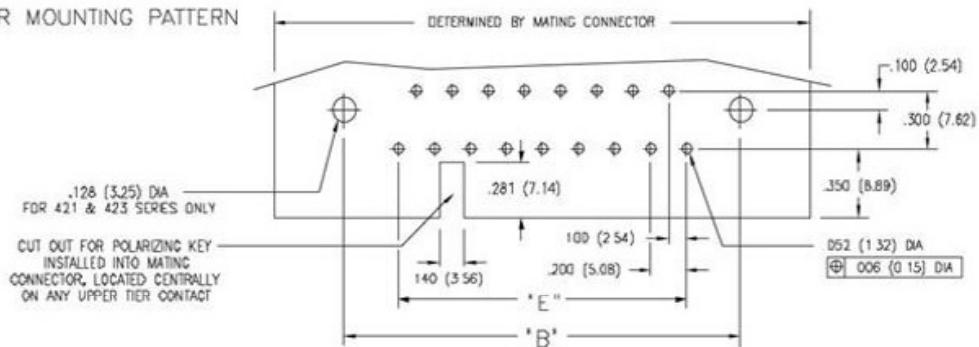

| NUMBER OF CONTACTS | "A" | | "B" | | "C" | "E" | "F" |
|--------------------|----------------|----------------|----------------|----------------|----------------|----------------|----------------|
| | 421 | 423 | 421 | 423 | | | |
| 17 | 2.370 (60.20) | 2.470 (62.74) | 2.100 (53.34) | 2.200 (55.88) | 1.714 (43.54) | 1.600 (40.64) | 1.900 (48.26) |
| 23 | 2.970 (75.44) | 3.070 (77.98) | 2.700 (68.58) | 2.800 (71.12) | 2.314 (58.78) | 2.200 (55.88) | 2.500 (63.50) |
| 29 | 3.570 (90.68) | 3.670 (93.22) | 3.300 (83.82) | 3.400 (86.36) | 2.914 (74.02) | 2.800 (71.12) | 3.100 (78.74) |
| 35 | 4.170 (105.92) | 4.270 (108.46) | 3.900 (99.06) | 4.000 (101.60) | 3.514 (89.26) | 3.400 (86.36) | 3.700 (93.98) |
| 41 | 4.770 (121.16) | 4.870 (123.70) | 4.500 (114.30) | 4.600 (116.84) | 4.114 (104.50) | 4.000 (101.60) | 4.300 (109.22) |
| 47 | 5.370 (136.40) | 5.470 (138.94) | 5.100 (129.54) | 5.200 (132.08) | 4.714 (119.74) | 4.600 (116.84) | 4.900 (124.46) |

408/424 SERIES METAL TO METAL (TWO PIECE) CONNECTOR

Receptacle

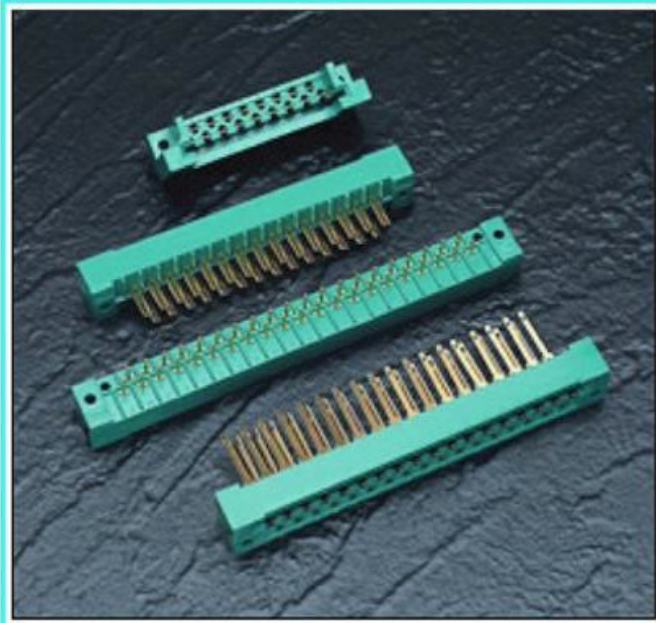

FEATURES

- .200 (5.08) Contact Spacing x .125 (3.18) or .150 (3.81) Row Spacing with Staggered Grid
- Accepts .062 (1.57) or .093 (2.36) Nominal Thickness P.C. Board
- Edacon Hermaphroditic Contact Mating Design
- Contact Termination Options include P.C. Tail, Fork Tail, Wire Hole and Wire Wrap
- Open or Closed Card Slot Ends, Card Guides Optional
- Accepts Polarizing Keys without Loss of Contact Position
- 408 Series without Card Guides Designed to Mate with 421 Series, 408 Series with Card Guides Designed to Mate with 422 Series, 424 Series Designed to Mate with 423 Series

SPECIFICATIONS

- ◆ Insulator Material: Polyphenylene Sulphide, UL 94V-0, Colour: Green
- ◆ Contact Material: Copper Alloy
- ◆ Contact Plating: Gold over Nickel for Entire Contact
- ◆ Current Rating: 10 Amperes
- ◆ Contact Resistance: 10 Milliohms Maximum
- ◆ Dielectric Withstanding Voltage: 2000 V AC rms at Sea Level
- ◆ Insulation Resistance: 5000 Megohms Minimum
- ◆ Operating Temperature: -65 to +125 Degrees C
- ◆ Insertion and Withdrawal Force: 2 to 16 oz (0.56 to 4.45 N) per Contact Position

408/424 SERIES ORDERING CODE

Example Part Number **424 - 041 - 500 - 112**

Series _____
 Total Number of Contacts _____
 Contact Code _____
 Card Slot Width & Mounting Options _____

| Series | Insulator Card Slot Ends |
|--------|-------------------------------------|
| 408 | Closed Card Slot Ends |
| 424 | Open Card Slot Ends per MIL-C-21097 |

Total Number of Contacts

017, 023, 029, 035, 041

| Contact Code ^{1,2} | Description & Tail Size | Tail Length "G" |
|-----------------------------|-------------------------------------|-----------------|
| 500 | Wire Hole .115 x .025 (2.92 x 0.64) | .326 (8.28) |
| 502 | Fork Tail .115 x .025 (2.92 x 0.64) | .168 (4.27) |
| 520 | P.C. Tail .044 x .025 (1.12 x 0.64) | .123 (3.12) |
| 521 | P.C. Tail .044 x .025 (1.12 x 0.64) | .154 (3.91) |
| 522 | P.C. Tail .044 x .025 (1.12 x 0.64) | .186 (4.72) |
| 523 | P.C. Tail .044 x .025 (1.12 x 0.64) | .123 (3.12) |
| 524 | P.C. Tail .044 x .025 (1.12 x 0.64) | .154 (3.91) |
| 525 | P.C. Tail .044 x .025 (1.12 x 0.64) | .186 (4.72) |
| 540 | Wire Wrap .060 x .025 (1.52 x 0.64) | .744 (18.90) |
| 541 | Wire Wrap .060 x .025 (1.52 x 0.64) | .744 (18.90) |
| 542 | Wire Wrap .060 x .025 (1.52 x 0.64) | .965 (24.51) |

| Card Slot Width and Mounting Options ³ | Description |
|---|--|
| 112 | Accepts .062 (1.57) Board .128 (3.25) Dia. Mounting Holes |
| 122 | Accepts .093 (2.36) Board .128 (3.25) Dia. Mounting Holes |
| 212 | Accepts .062 (1.57) Board .128 (3.25) Dia. Mounting Holes With Card Guides |
| 222 | Accepts .093 (2.36) Board .128 (3.25) Dia. Mounting Holes With Card Guides |

Ordering Code Notes

- 1) Contact codes 523, 524 and 525 are designed for .150 (3.81) row spacing connectors.
- 2) Contact code 540 has a wire hole at the tip of the tail (page 69).
- 3) Mounting options 212 and 222 are available on the 408 series connectors only.

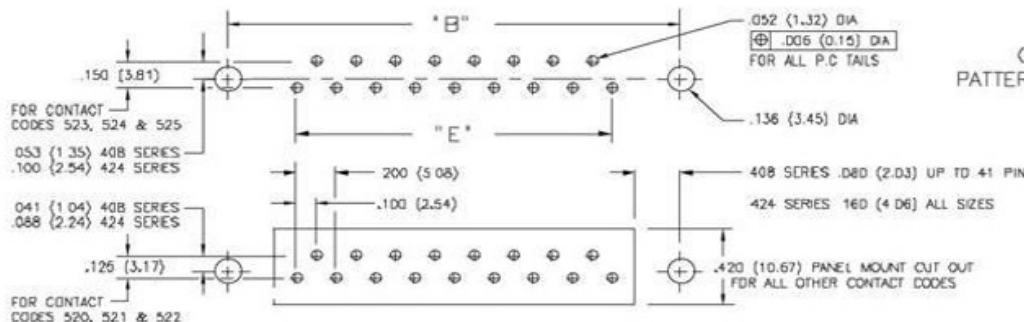

CONNECTOR MOUNTING PATTERNS FOR 408 & 424 SERIES

METAL TO METAL (TWOPIECE) CONNECTOR SERIES 408/424

Receptacle

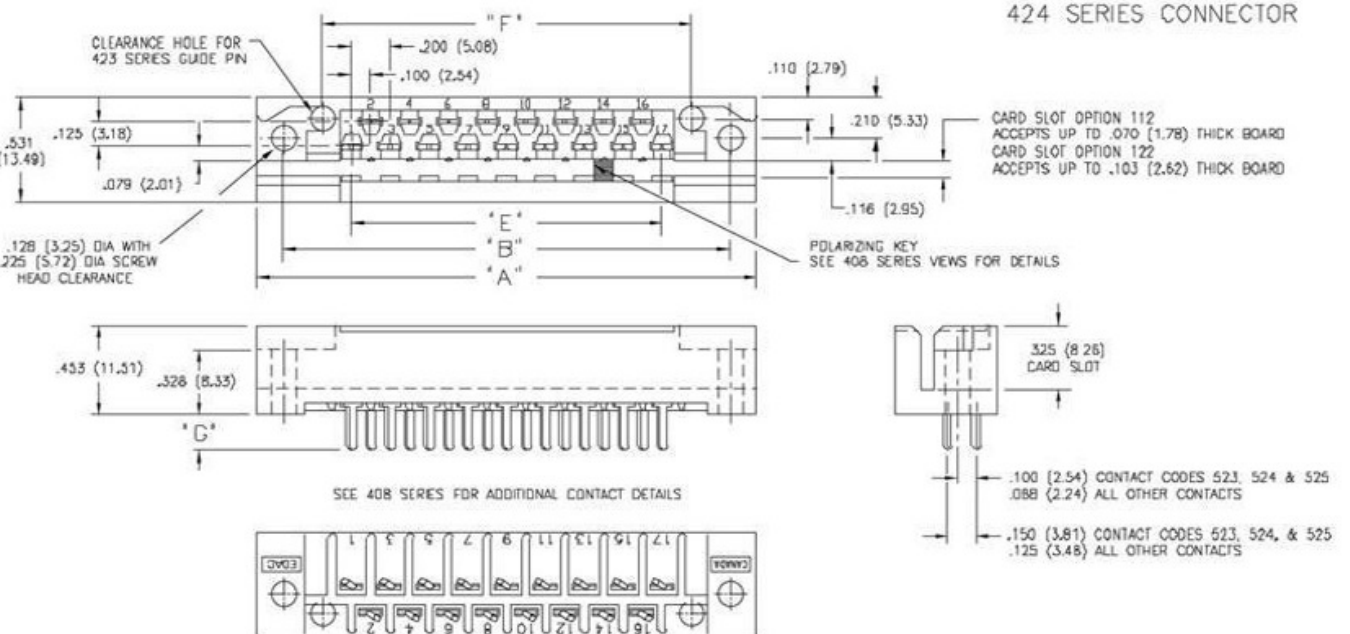
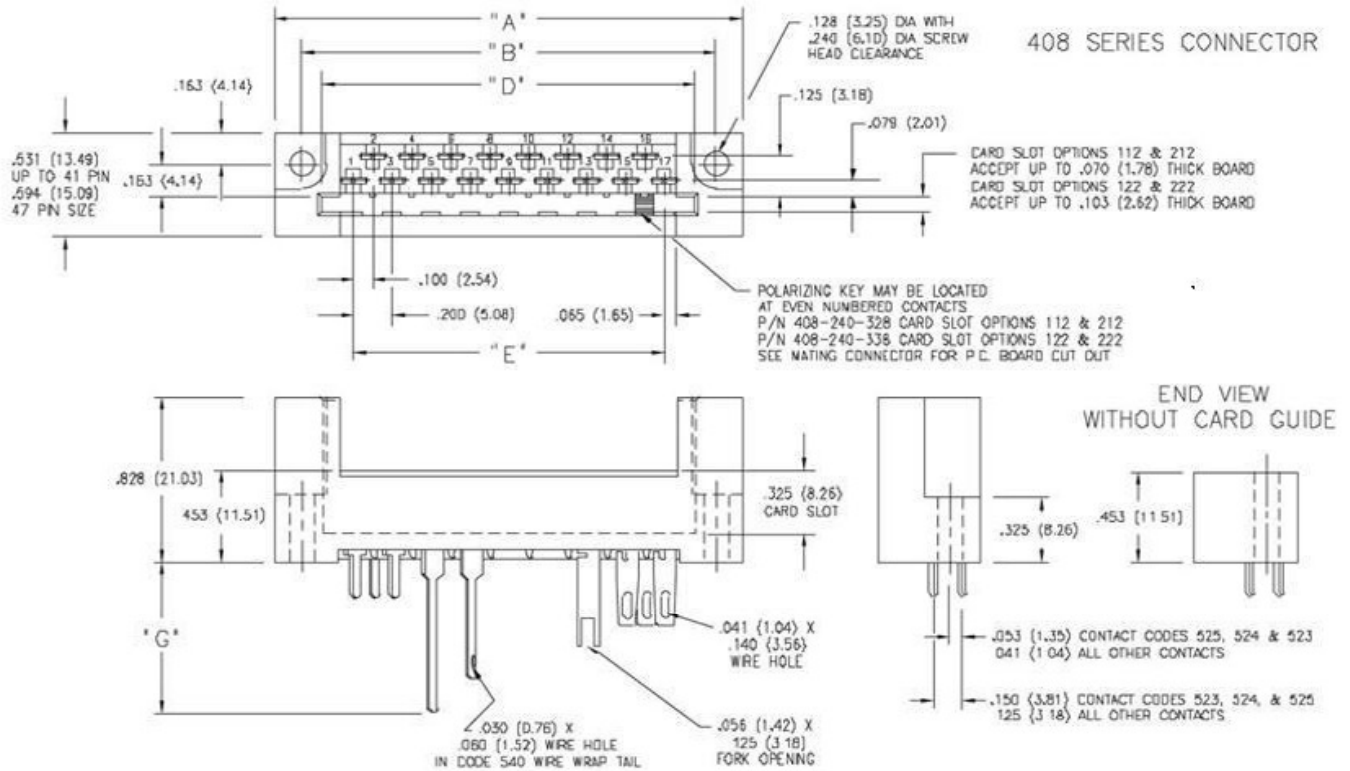

| NUMBER OF CONTACTS | "A" | | "B" | | "D" | "E" | "F" |
|--------------------|----------------|----------------|----------------|----------------|----------------|----------------|----------------|
| | 408 | 424 | 408 | 424 | 408 | 408, 424 | 424 |
| | Inch (mm) | Inch (mm) | Inch (mm) | Inch (mm) | Inch (mm) | Inch (mm) | Inch (mm) |
| 17 | 2.406 (61.11) | 2.570 (65.28) | 2.134 (54.20) | 2.300 (58.42) | 1.920 (48.77) | 1.800 (40.64) | 1.900 (48.26) |
| 23 | 3.006 (76.35) | 3.170 (80.52) | 2.734 (69.44) | 2.900 (73.66) | 2.520 (64.01) | 2.200 (55.88) | 2.500 (63.50) |
| 29 | 3.606 (91.59) | 3.770 (95.76) | 3.334 (84.68) | 3.500 (88.90) | 3.120 (79.25) | 2.800 (71.12) | 3.100 (78.74) |
| 35 | 4.206 (106.83) | 4.370 (111.00) | 3.934 (99.92) | 4.100 (104.14) | 3.720 (94.49) | 3.400 (86.36) | 3.700 (93.98) |
| 41 | 4.806 (122.07) | 4.970 (126.24) | 4.534 (115.16) | 4.700 (119.38) | 4.320 (109.73) | 4.000 (101.60) | 4.300 (109.22) |

415/438 SERIES METAL TO METAL (TWO PIECE) CONNECTOR

Receptacle

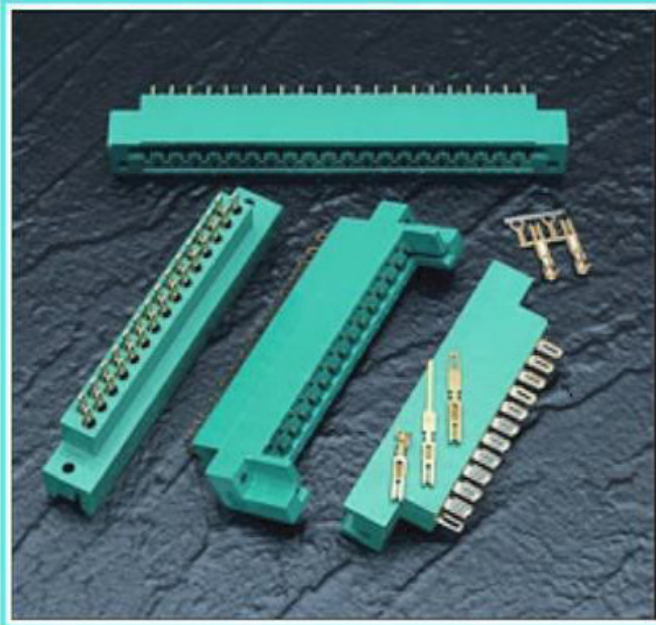

FEATURES

- .200 (5.08) Contact Spacing x .125 (3.18) Row Spacing with Staggered Grid
- Accepts .062 (1.57) or .093 (2.36) Nominal Thickness P.C. Board
- Edacon Hermaphroditic Contact Mating Design
- Contact Termination Options include Crimp, P.C. Tail, Wire Hole and Wire Wrap
- Open or Closed Card Slot Ends, Card Guides Optional
- Accepts Polarizing Keys without Loss of Contact Position
- 415 Series without Card Guides Designed to Mate with 421 Series, 415 Series with Card Guides Designed to Mate with 422 Series, 438 Series Designed to Mate with 423 Series

SPECIFICATIONS

- ◆ Insulator Material: Diallyl Phthalate, UL 94V-0, Colour: Green
- ◆ Contact Material: Copper Alloy
- ◆ Contact Plating: Gold over Nickel for Entire Contact
- ◆ Current Rating: 8.5 Amperes
- ◆ Contact Resistance: 10 Milliohms Maximum
- ◆ Dielectric Withstanding Voltage: 2000 V AC rms at Sea Level
- ◆ Insulation Resistance: 5000 Megohms Minimum
- ◆ Operating Temperature: -65 to +125 Degrees C
- ◆ Insertion and Withdrawal Force: 2 to 16 oz (0.56 to 4.45 N) per Contact Position

415/438 SERIES ORDERING CODE

Example Part Number **415 - 035 - 500 - 212**

Series _____
 Total Number of Contacts _____
 Contact Code _____
 Card Slot Width & Mounting Options _____

| Series | Insulator Card Slot Ends |
|--------|--------------------------|
| 415 | Closed Card Slot Ends |
| 438 | Open Card Slot Ends |

Total Number of Contacts
 017, 023, 029, 035, 041 or 047

| Contact Code | Description & Tail Size | Tail Length "G" |
|--------------|-------------------------------------|-----------------|
| 000 | No Contacts Assembled | — |
| 500 | Wire Hole .110 x .024 (2.79 x 0.61) | .245 (6.22) |
| 520 | P.C. Tail .025 x .024 (0.64 x 0.61) | .215 (5.46) |
| 540 | Wire Wrap .050 x .024 (1.27 x 0.61) | .600(15.24) |
| 541 | Wire Wrap .026 x .024 (0.66 x 0.61) | .620(15.75) |
| 542 | Wire Wrap .050 x .025 (1.27 x 0.61) | .790(20.07) |

| Card Slot Width and Mounting Options ³ | Description |
|---|--|
| 112 | Accepts .062 (1.57) Board .128 (3.25) Dia. Mounting Holes |
| 122 | Accepts .093 (2.36) Board .128 (3.25) Dia. Mounting Holes |
| 212 | Accepts .062 (1.57) Board .128 (3.25) Dia. Mounting Holes With Card Guides |
| 222 | Accepts .093 (2.36) Board .128 (3.25) Dia. Mounting Holes With Card Guides |

Ordering Code Notes

- 1) Crimp contacts are also available for the 415 and 438 series connectors. Contacts may be ordered separately for pre-wired or select position assembly.

| Part Number | Description | Silhouette |
|-------------|--------------------------------|------------|
| 516-290-500 | Wire Hole | |
| 516-290-520 | P.C. Tail | |
| 516-290-540 | Wire Wrap | |
| 516-290-541 | Wire Wrap | |
| 516-290-542 | Wire Wrap | |
| 516-290-590 | Crimp - Loose | |
| 516-290-591 | Crimp - 1800 Contacts per Reel | |

- 2) For contact installation, removal and crimping tools, refer to page 72.
- 3) Mounting options 212 and 222 are available on the 415 series connectors only.

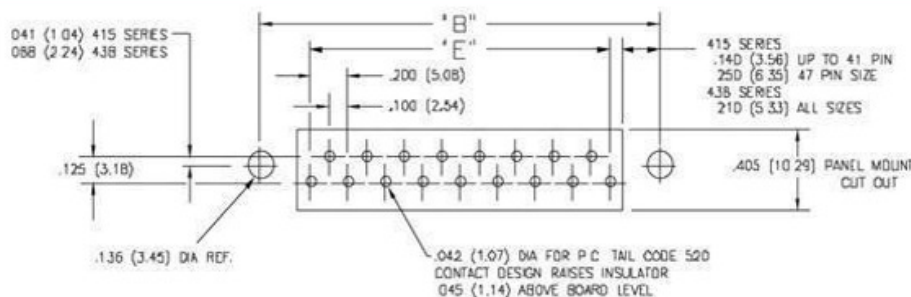

CONNECTOR MOUNTING PATTERN FOR 415 & 438 SERIES

METAL TO METAL (TWO PIECE) CONNECTOR SERIES 415/438

Receptacle

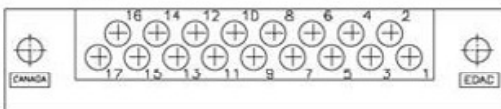
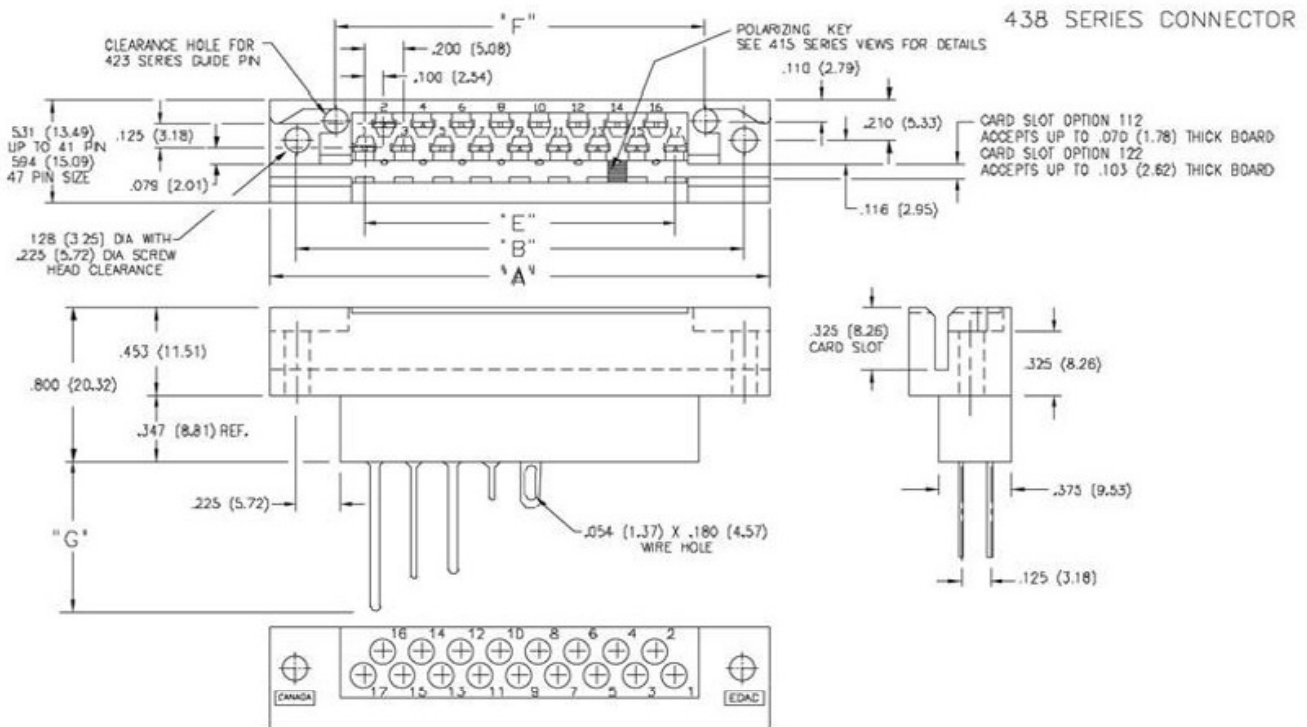
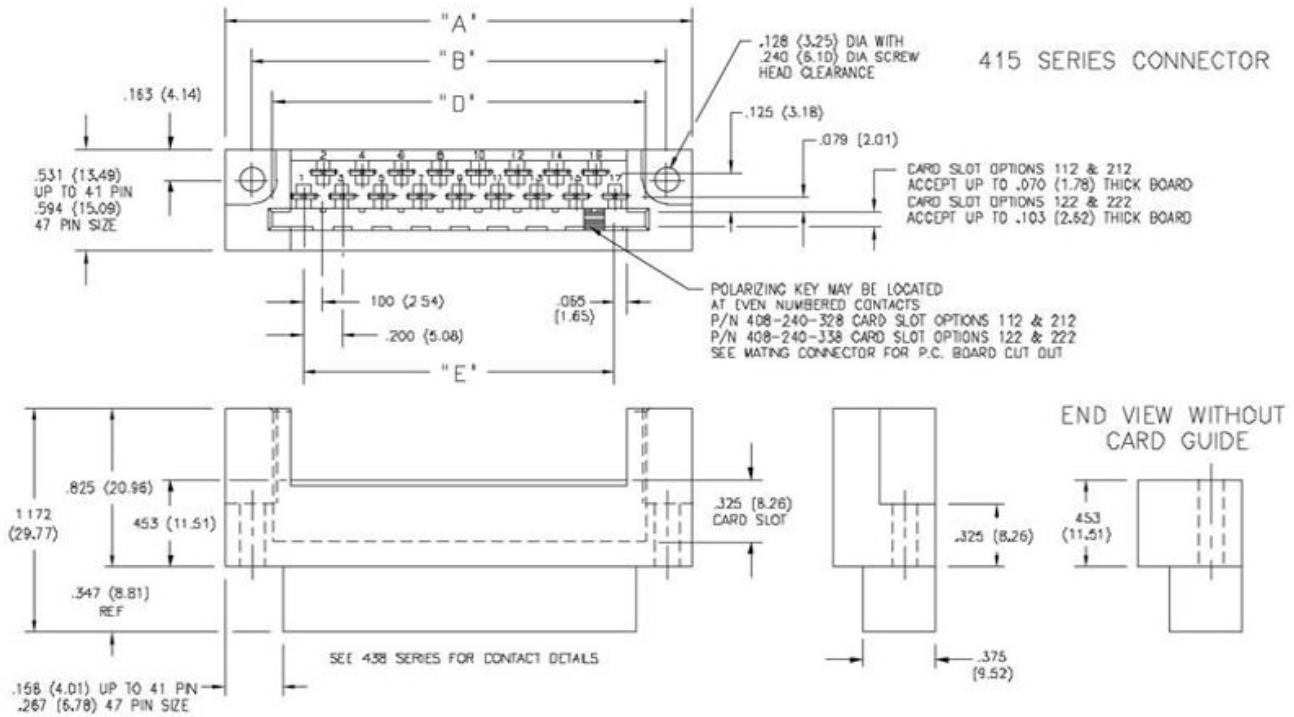

| NUMBER OF CONTACTS | "A" | | "B" | | "D" | | "E" | | "F" | |
|--------------------|----------------|----------------|----------------|----------------|----------------|----------------|----------------|-----------|-----------|-----------|
| | 415 | 438 | 415 | 438 | 415 | 415, 438 | 415, 438 | 438 | 415 | 438 |
| | Inch (mm) | Inch (mm) | Inch (mm) | Inch (mm) | Inch (mm) | Inch (mm) | Inch (mm) | Inch (mm) | Inch (mm) | Inch (mm) |
| 17 | 2.406 (61.11) | 2.570 (65.28) | 2.134 (54.20) | 2.300 (58.42) | 1.920 (48.77) | 1.600 (40.64) | 1.900 (48.26) | | | |
| 23 | 3.006 (76.35) | 3.170 (80.52) | 2.734 (69.44) | 2.900 (73.66) | 2.520 (64.01) | 2.200 (55.88) | 2.500 (63.50) | | | |
| 29 | 3.606 (91.59) | 3.770 (95.76) | 3.334 (84.68) | 3.500 (88.90) | 3.120 (79.25) | 2.800 (71.12) | 3.100 (78.74) | | | |
| 35 | 4.206 (106.83) | 4.370 (111.00) | 3.934 (99.92) | 4.100 (104.14) | 3.720 (94.49) | 3.400 (86.36) | 3.700 (93.98) | | | |
| 41 | 4.806 (122.07) | 4.970 (126.24) | 4.534 (115.16) | 4.700 (119.38) | 4.320 (109.73) | 4.000 (101.60) | 4.300 (109.22) | | | |
| 47 | 5.620 (142.75) | 5.570 (141.48) | 5.352 (135.94) | 5.300 (134.62) | 5.030 (127.76) | 4.600 (116.84) | 4.900 (124.46) | | | |

417 SERIES METAL TO METAL (TWO PIECE) CONNECTOR

Plug

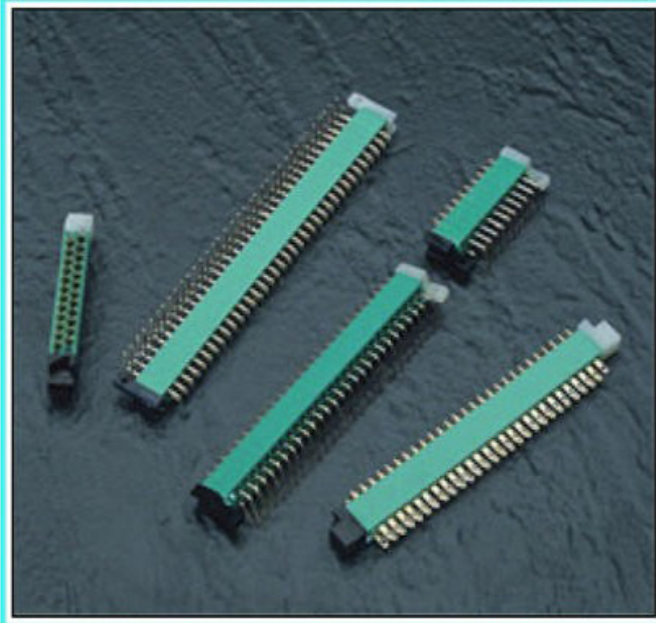

417 SERIES ORDERING CODE

Example Part Number **417 - 054 - 560 - 401**

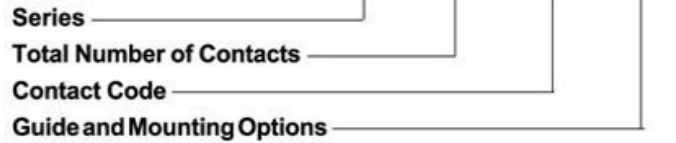

Series 417

| Total Number of Contacts ¹ | Description |
|---------------------------------------|----------------------------|
| 002, 004,...076 | With End Guides Only |
| 004, 008,...152 | With End and Centre Guides |

| Contact Code ² | Description & Tail Size | Tail Length "G" |
|---------------------------|--|-----------------|
| 500 | Wire Hole .054 x .020 (1.37 x 0.51) | .157 (3.99) |
| 520 | P.C. Tail .020 (0.51) Square | .093 (2.36) |
| 522 | P.C. Tail .020 (0.51) Octagonal | .250 (6.35) |
| 541 | P.C. Tail .020 (0.51) Octagonal | .453(11.51) |
| 560 | 90 Degree Bend (Code 522 and 541 Contacts) | |
| 561 | 90 Degree Bend (Code 522 and 541 Contacts) | |

| Guide and Mounting Options ² | Description |
|---|--|
| 401 | End Guides Only - 2 Mounting Holes |
| 501 | End and Centre Guides - 3 Mounting Holes |

Ordering Code Notes

- 1) All connector sizes up to 76 contacts (end guides only) or up to 152 contacts (end and centre guides) are available upon request.
- 2) Connectors with wire hole or p.c. tail contacts are supplied with self tapping screws. Connectors with 90 degree bend contacts are supplied with eyelets.

FEATURES

- .100 (2.54) Contact Spacing x .100 (2.54) Row Spacing with Staggered Grid
- Edacon Hermaphroditic Contact Mating Design
- Contact Termination Options include P.C. Tail, Wire Hole and 90 Degree Bends
- Polarizing End Guides Included, Centre Guide Optional
- Self Tapping Screws or Mounting Eyelets Supplied
- Designed to Mate with 418 Series

SPECIFICATIONS

- ◆ Insulator Material: Polyphenylene Sulphide, UL 94V-0, Colour: Green
- ◆ **Contact Material: Copper Alloy**
- ◆ Contact Plating: Gold over Nickel for Entire Contact
- ◆ Current Rating: 5 Amperes Continuous
- ◆ Contact Resistance: 10 Milliohms Maximum
- ◆ Dielectric Withstanding Voltage: 1000 V AC rms at Sea Level
- ◆ Insulation Resistance: 5000 Megohms Minimum
- ◆ Operating Temperature: -65 to +125 Degrees C
- ◆ Insertion and Withdrawal Force: 2 to 16 oz (0.56 to 4.45 N) per Contact Position

METAL TO METAL (TWO PIECE) CONNECTOR SERIES 417

Plug

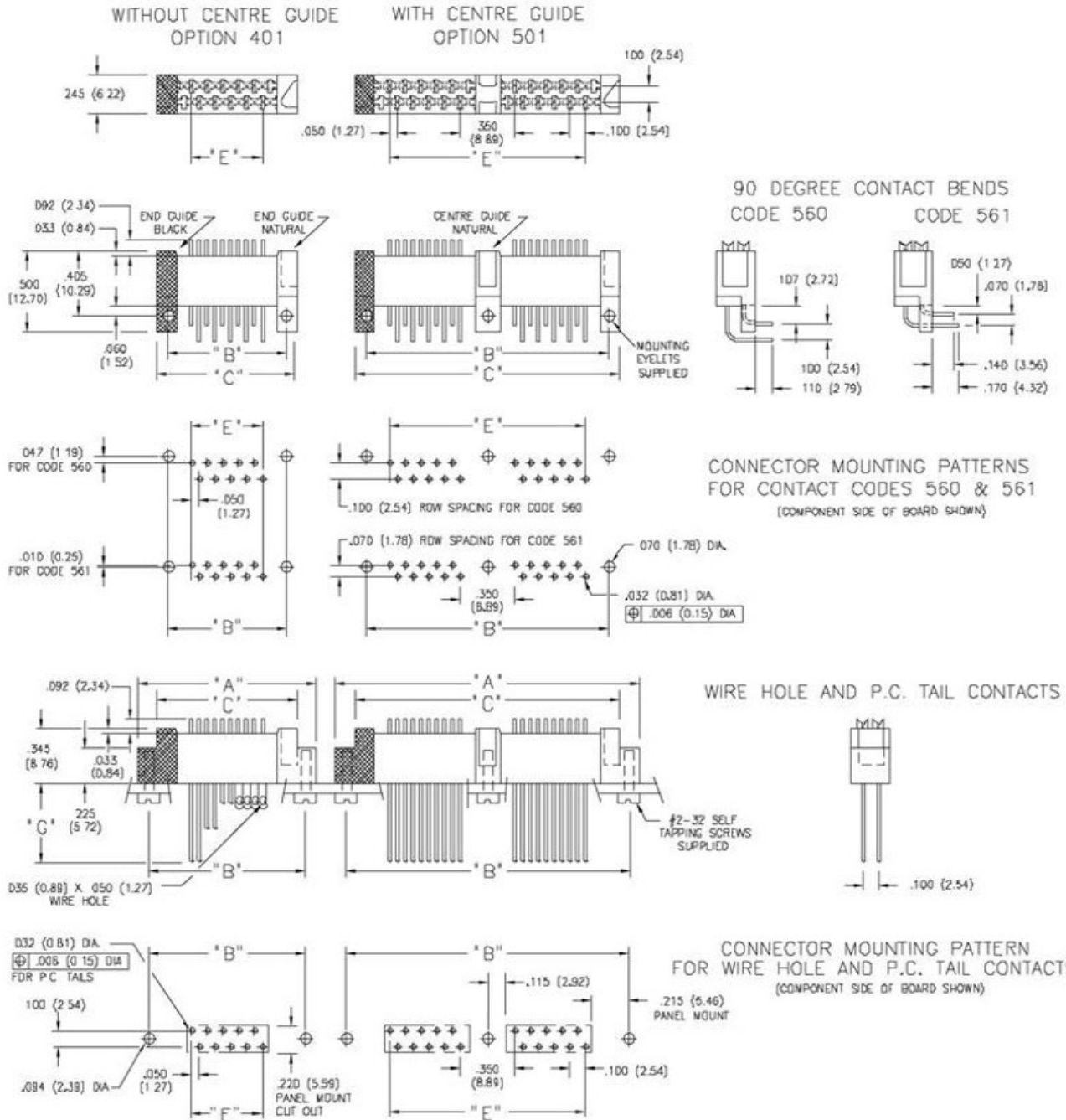

| WITHOUT CENTRE GUIDE | "A" | "B" Straight Tails | "B" 90° Bend Tails | "C" | "E" |
|----------------------|----------------|--------------------|--------------------|----------------|----------------|
| NUMBER OF CONTACTS | Inch (mm) | Inch (mm) | Inch (mm) | Inch (mm) | Inch (mm) |
| 2 | .740 (18.80) | .600 (15.24) | .350 (8.89) | .490 (12.45) | .050 (1.27) |
| 20 | 1.640 (41.66) | 1.500 (38.10) | 1.250 (31.75) | 1.390 (35.31) | .950 (24.13) |
| 42 | 2.740 (69.60) | 2.600 (66.04) | 2.350 (59.69) | 2.490 (63.25) | 2.050 (52.07) |
| 54 | 3.340 (84.84) | 3.200 (81.28) | 2.950 (74.93) | 3.090 (78.49) | 2.650 (67.31) |
| 70 | 4.140 (105.16) | 4.000 (101.60) | 3.750 (95.25) | 3.890 (98.81) | 3.450 (87.63) |
| 76 | 4.440 (112.78) | 4.300 (109.22) | 4.050 (102.87) | 4.190 (106.43) | 3.750 (95.25) |
| WITH CENTRE GUIDE | "A" | "B" Straight Tails | "B" 90° Bend Tails | "C" | "E" |
| NUMBER OF CONTACTS | Inch (mm) | Inch (mm) | Inch (mm) | Inch (mm) | Inch (mm) |
| 4 | 1.140 (28.96) | 1.000 (25.40) | .750 (19.05) | .890 (22.61) | .450 (11.43) |
| 104 | 6.140 (155.96) | 6.000 (152.40) | 5.750 (146.05) | 5.890 (149.61) | 5.450 (138.43) |
| 108 | 6.340 (161.04) | 6.200 (157.48) | 5.950 (151.13) | 6.090 (154.69) | 5.650 (143.51) |
| 152 | 8.540 (216.92) | 8.400 (213.36) | 8.150 (207.01) | 8.290 (210.57) | 7.850 (199.39) |

418 SERIES METAL TO METAL (TWO PIECE) CONNECTOR

Receptacle

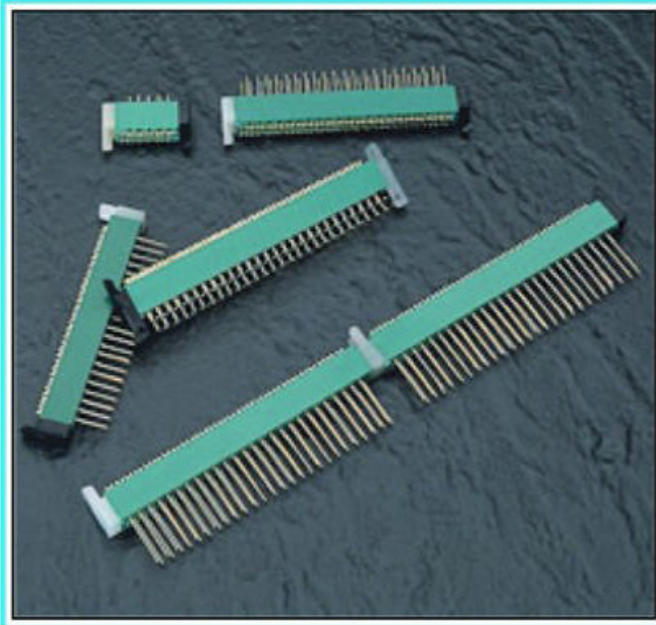

FEATURES

- .100 (2.54) Contact Spacing x .100 (2.54) Row Spacing with Staggered Grid
- Edacon Hermaphroditic Contact Mating Design
- Contact Termination Options include P.C. Tail, Wire Hole and 90 Degree Bends
- Polarizing End Guides Included, Centre Guide Optional
- Self Tapping Screws or Mounting Eyelets Supplied
- Designed to Mate with 417 Series

SPECIFICATIONS

- ◆ Insulator Material: Polyphenylene Sulphide, UL 94V-0, Colour: Green
- ◆ **Contact Material: Copper Alloy**
- ◆ Contact Plating: Gold over Nickel for Entire Contact
- ◆ Current Rating: 5 Amperes Continuous
- ◆ Contact Resistance: 10 Milliohms Maximum
- ◆ Dielectric Withstanding Voltage: 1000 V AC rms at Sea Level
- ◆ Insulation Resistance: 5000 Megohms Minimum
- ◆ Operating Temperature: -65 to +125 Degrees C
- ◆ Insertion and Withdrawal Force: 2 to 16 oz (0.56 to 4.45 N) per Contact Position

418 SERIES ORDERING CODE

Example Part Number **418 - 108 - 520 - 501**

Series _____
 Total Number of Contacts _____
 Contact Code _____
 Guide and Mounting Options _____

Series 418

| Total Number of Contacts ¹ | Description |
|---------------------------------------|----------------------------|
| 002, 004,...076 | With End Guides Only |
| 004, 008,...152 | With End and Centre Guides |

| Contact Code ² | Description & Tail Size | Tail Length "G" |
|---------------------------|--|-----------------|
| 500 | Wire Hole .054 x .020 (1.37 x 0.51) | .187 (4.75) |
| 520 | P.C. Tail .020 (0.51) Square | .123 (3.12) |
| 522 | P.C. Tail .020 (0.51) Octagonal | .280 (7.11) |
| 541 | P.C. Tail .020 (0.51) Octagonal | .483 (12.27) |
| 560 | 90 Degree Bend (Code 522 and 541 Contacts) | |
| 561 | 90 Degree Bend (Code 522 and 541 Contacts) | |

| Guide and Mounting Options ² | Description |
|---|--|
| 401 | End Guides Only - 2 Mounting Holes |
| 501 | End and Centre Guides - 3 Mounting Holes |

Ordering Code Notes

- 1) All connector sizes up to 76 contacts (end guides only) or up to 154 contacts (end and centre guides) are available upon request.
- 2) Connectors with wire hole or p.c. tail contacts are supplied with self tapping screws. Connectors with 90 degree bend contacts are supplied with eyelets for the end guides only.

METAL TO METAL (TWO PIECE) CONNECTOR SERIES 418

Receptacle

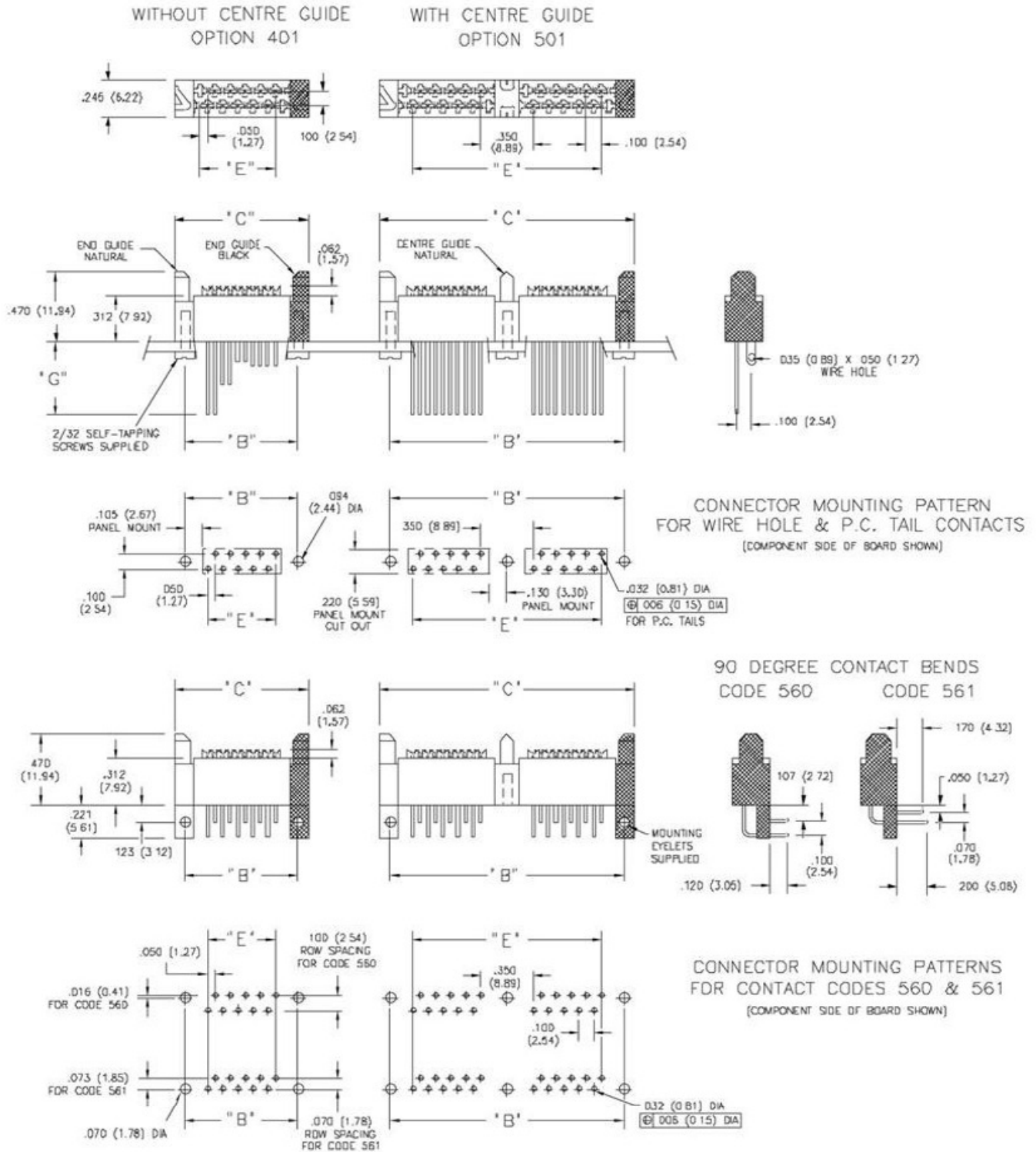

| WITHOUT CENTRE GUIDE | | | | WITH CENTRE GUIDE | | | |
|----------------------|----------------|----------------|---------------|--------------------|----------------|----------------|----------------|
| NUMBER OF CONTACTS | "B" | "C" | "E" | NUMBER OF CONTACTS | "B" | "C" | "E" |
| | Inch (mm) | Inch (mm) | Inch (mm) | | Inch (mm) | Inch (mm) | Inch (mm) |
| 2 | .350 (8.89) | .490 (12.45) | .050 (1.27) | 4 | .750 (19.05) | .890 (22.61) | .450 (11.43) |
| 20 | 1.250 (31.75) | 1.390 (35.31) | .950 (24.13) | 104 | 5.750 (146.05) | 5.890 (149.61) | 5.450 (138.43) |
| 42 | 2.350 (59.69) | 2.490 (63.25) | 2.050 (52.07) | 108 | 5.950 (151.13) | 6.090 (154.69) | 5.650 (143.51) |
| 54 | 2.950 (74.93) | 3.090 (78.49) | 2.650 (67.31) | 152 | 8.150 (207.01) | 8.290 (210.57) | 7.850 (199.39) |
| 70 | 3.750 (95.25) | 3.890 (98.81) | 3.450 (87.63) | | | | |
| 76 | 4.050 (102.87) | 4.190 (106.43) | 3.750 (95.25) | | | | |

516 SERIES RACK & PANEL CONNECTOR

Plug and Receptacle

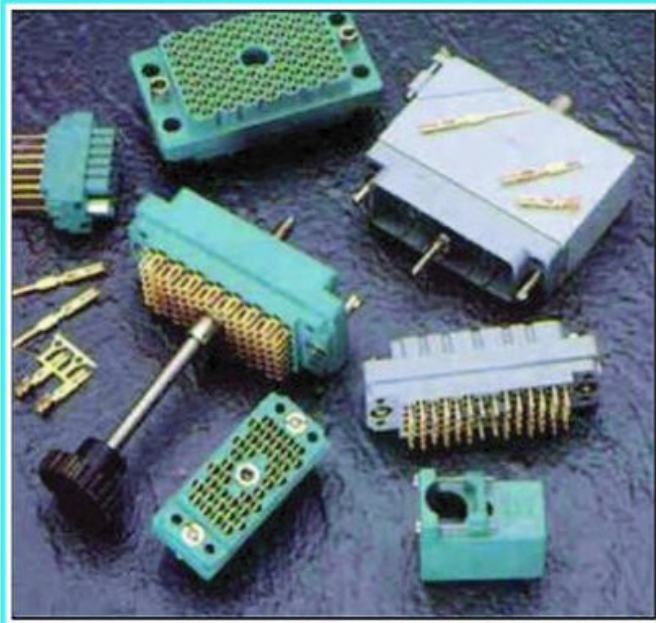

FEATURES

- UL Recognized
- .150 (3.81) Contact Spacing x .130 (3.30) or .150 (3.81) Row Spacing with Staggered Grid
- Plug and Receptacle in 20, 38, 56, 90 or 120 Contact Sizes
- Edacon Hermaphroditic Contact Mating Design
- Contact Termination Options include Crimp, P.C. Tail, Wire Hole and Wire Wrap
- Mating and Unmating Simplified with use of Actuating Screws
- Optional Covers with Side or Top Entry Cable Clamp in Plastic or Metal Material Available for all Connector Sizes
- Versatile Metal Cover Design permits Assembly or Disassembly After Cabling is Complete plus Cable Entry Style Flexibility
- Actuating Screws, Locknuts, Polarizing Hardware, Covers and Contacts Suitable for either Plug or Receptacle
- Polarizing Hardware Adjustable for 288 Mating Combinations
- Tools Available for Contact Installation, Removal and Crimping and Polarizing Changes

SPECIFICATIONS

- ◆ Insulator Material: Diallyl Phthalate or Thermoplastic Polyester, UL 94V-0, Colour: Green, or Polycarbonate, Colour: Grey
- ◆ **Contact Material: Copper Alloy**
- ◆ Contact Plating: Gold over Nickel for Entire Contact
- ◆ Cover Material: Polycarbonate, Colour: Green, or Die-Cast Zinc, Finished with Grey Enamel Paint
- ◆ Current Rating: 8.5 Amperes
- ◆ Contact Resistance: 10 Milliohms Maximum
- ◆ Dielectric Withstanding Voltage: 2000 V AC rms at Sea Level
- ◆ Insulation Resistance: 5000 Megohms Minimum
- ◆ Operating Temperature: -65 to +125 Degrees C
- ◆ Insertion and Withdrawal Force: 2 to 16 oz (0.56 to 4.45 N) per Contact Position

516 SERIES ORDERING CODE

Example Part Number **516 - 038 - 500 - 2 1 2**

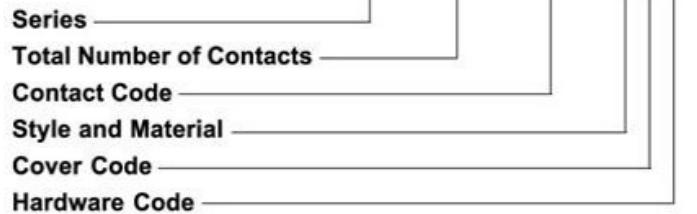

Series 516

Total Number of Contacts

020, 038, 056, 090 or 120

| Contact Code ^{1,2} | Description & Tail Size | Tail Length "G" |
|-----------------------------|-------------------------------------|-----------------|
| 000 | No Contacts Assembled | — — |
| 500 | Wire Hole .110 x .024 (2.79 x 0.61) | .245 (6.22) |
| 520 | P.C. Tail .025 x .024 (0.64 x 0.61) | .215 (5.46) |
| 540 | Wire Wrap .050 x .024 (1.27 x 0.61) | .600 (15.24) |
| 541 | Wire Wrap .026 x .024 (0.66 x 0.61) | .620 (15.75) |
| 542 | Wire Wrap .050 x .024 (1.27 x 0.61) | .790 (20.07) |

| Style and Material ³ | Style | Insulator Material |
|---------------------------------|------------|-------------------------|
| 1 | Plug | Green Diallyl Phthalate |
| 2 | Receptacle | Green Diallyl Phthalate |
| 3 | Plug | Grey Polycarbonate |
| 4 | Receptacle | Grey Polycarbonate |
| 5 | Plug | Green Polyester |
| 6 | Receptacle | Green Polyester |

| Cover Code ^{4,5,6,7} | Description |
|-------------------------------|--|
| 0 | No Cover Assembled |
| 1 | Plastic Cover, Top Entry Standard Clamp |
| 2 | Plastic Cover, Side Entry Standard Clamp |
| 3 | Plastic Cover, Top Entry Large Clamp |
| 4 | Plastic Cover, Side Entry Large Clamp |
| 5 | Metal Cover, Side Entry |
| 6 | Metal Cover, Top Entry |

| Hardware Code ⁸ | Description |
|----------------------------|---|
| 0 | No Hardware Assembled |
| 1 | Actuating Screw and Polarizing Hardware |
| 2 | Locknut and Polarizing Hardware |
| 5 | Actuating Screw with No Polarizing Hardware |
| 6 | Locknut with No Polarizing Hardware |

Ordering Code Notes

1) Crimp contacts are also available for the 516 series connectors. Contacts may be ordered separately for pre-wired or select position assembly.

| Part Number | Description | Silhouette |
|-------------|--------------------------------|------------|
| 516-290-500 | Wire Hole | |
| 516-290-520 | P.C. Tail | |
| 516-290-540 | Wire Wrap | |
| 516-290-541 | Wire Wrap | |
| 516-290-542 | Wire Wrap | |
| 516-290-590 | Crimp - Loose | |
| 516-290-591 | Crimp - 1800 Contacts per reel | |

Continued on next page

RACK & PANEL CONNECTOR SERIES 516

Plug and Receptacle

TYPICAL PLUG WITH ACTUATING SCREW AND POLARIZING GUIDE PINS

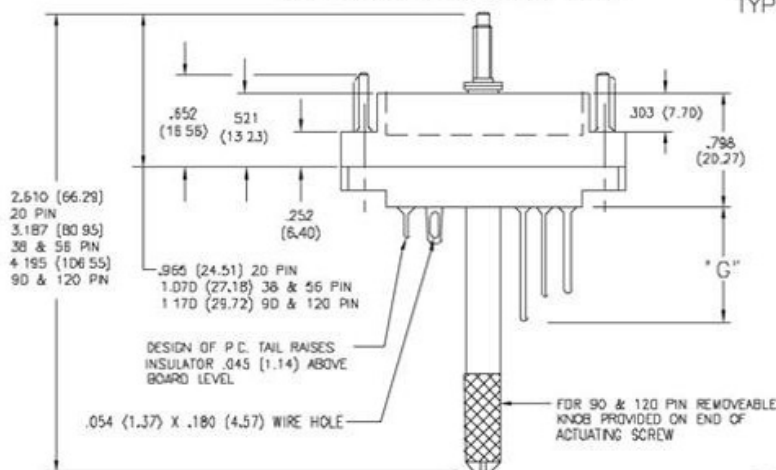

TYPICAL RECEPTACLE WITH LOCKNUT AND POLARIZING SOCKETS

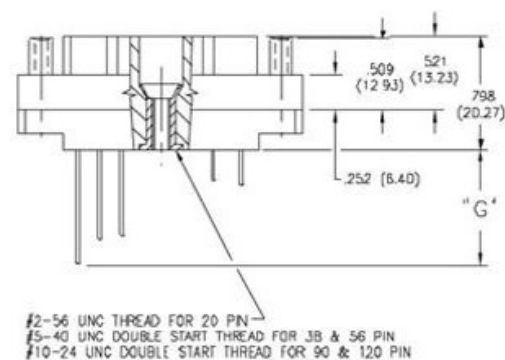

TYPICAL PLUG WITH ACTUATING SCREW, POLARIZING GUIDE PINS AND COVER

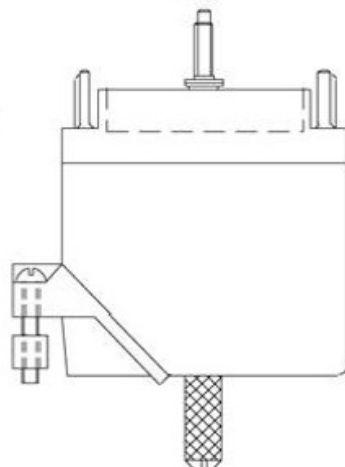

TYPICAL RECEPTACLE WITH LOCKNUT, POLARIZING SOCKETS AND COVER

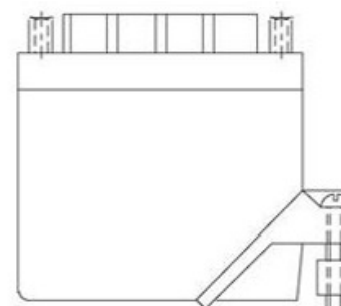

NOTE: PLASTIC POLARIZING GUIDE PINS AND SOCKETS (AVAILABLE SOON) WILL BE COLOUR CODED TO VISUALLY ASSIST CONNECTOR MATING. POLARIZATION CHANGES WILL ALSO BE SIMPLIFIED AS THEY WILL SNAP FIRMLY INTO POSITION AND CAN BE REPLACED USING NEEDLENOSE PLIERS.

ORDERING CODE NOTES (Continued)

- 2) For contact installation, removal and crimping tools, refer to page 72.
- 3) Grey polycarbonate insulator material is not available for the 120 pin size connector.
- 4) The 20 pin connector cover will not accept the length of the wire wrap contacts.
- 5) Plastic covers with large clamps are only available for the 38 and 56 pin size connectors.
- 6) Metal covers with side entry may be converted to top entry by removing side plate and changing clamp orientation.
- 7) Covers may be ordered separately. Refer to page 88.
- 8) Insulator design prevents improper mating of individual plug and receptacle. Polarizing hardware enables specific plug and receptacle mating combinations.

CRIMP CHARACTERISTICS

- Contacts and Crimp Tools Accommodate from 28 AWG to 18 AWG, Solid or Stranded Conductor Diameters from .012 (0.30) to .049 (1.25) and an Insulation Diameter up to .074 (1.88)
- Multiple Smaller Gauge Wires may be Crimped Together
- Crimp Resistance from 0.5 Milliohms (18 AWG) to 1.5 Milliohms (28AWG)

POLARIZING CODES

- Polarizing Hardware Changes allow 288 Mating Combinations
- Standard Code Supplied for Plugs PG1G1, for Receptacles RS1S1. Connectors with Special Polarizing Codes Available upon Request
- Example Polarizing Code:

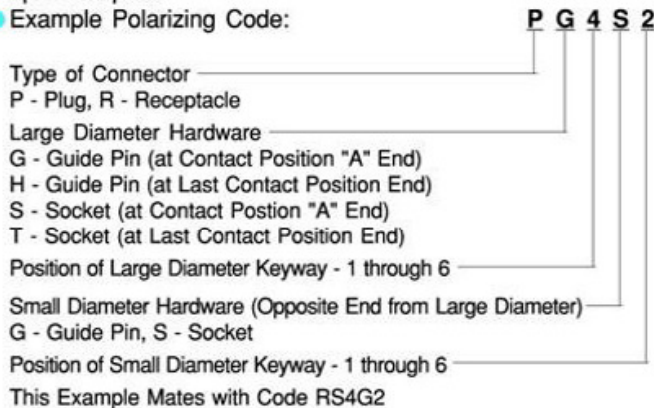

- Crimp Tensile Strength for Wire Sizes

| | |
|-------------------------|-------------------------|
| 18 AWG - 40 lbs (178 N) | 20 AWG - 25 lbs (111 N) |
| 22 AWG - 15 lbs (67 N) | 24 AWG - 10 lbs (44 N) |
| 26 AWG - 5 lbs (22 N) | 28 AWG - 3 lbs (13 N) |

516 SERIES RACK & PANEL CONNECTOR

Plug and Receptacle

CONNECTOR MATING FACE VIEWS

DIMENSIONS INDICATED FOR EACH SIZE APPLY TO BOTH PLUG AND RECEPTACLE

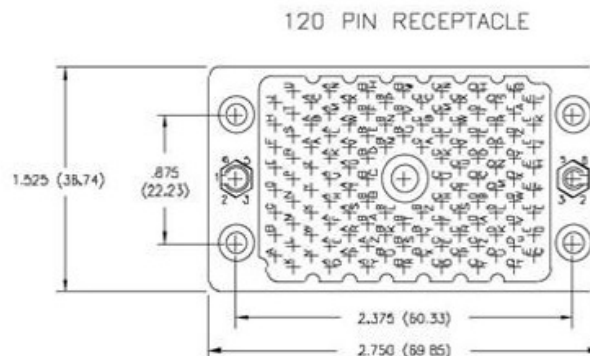
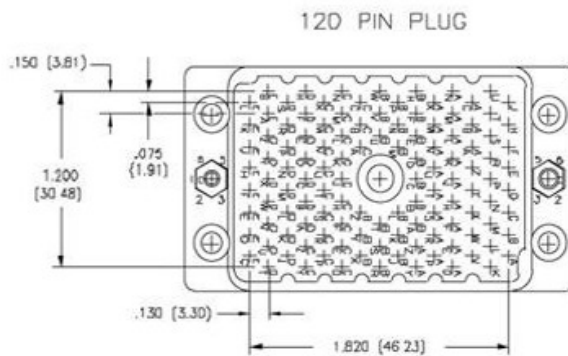
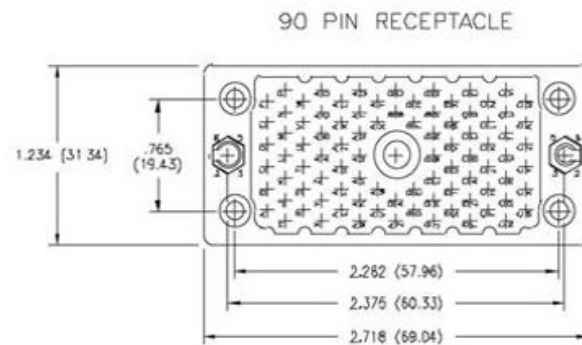
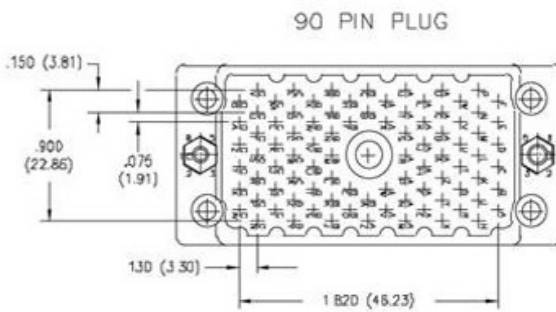
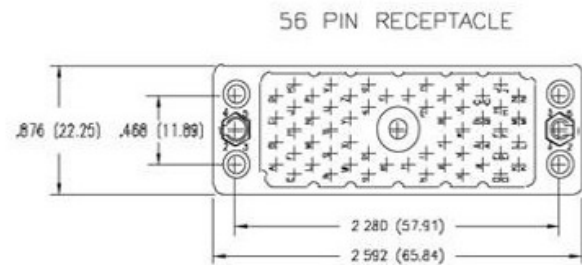
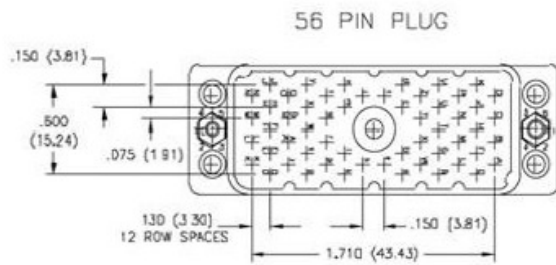
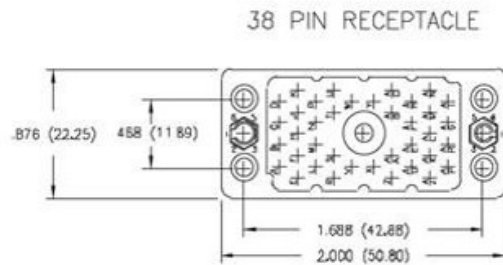
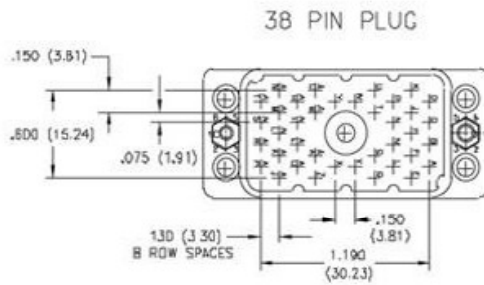
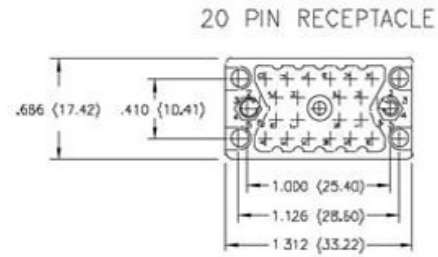
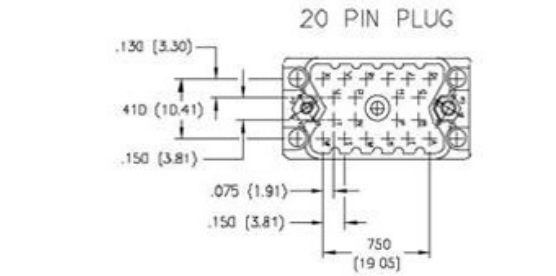

RACK & PANEL CONNECTOR SERIES 516

Metal and Plastic Covers

516 SERIES COVER ORDERING CODE

Example Part Number **516 - 230 - 5 56**

Series _____
 Cover Identification Code _____
 Cover Type _____
 Cover Size _____

Series **516**

Cover Identification Code **230**

| Cover Type ^{1,2} | Description |
|---------------------------|--|
| 1 | Plastic Cover, Side Entry Standard Clamp |
| 2 | Plastic Cover, Top Entry Standard Clamp |
| 3 | Plastic Cover, Side Entry Large Clamp |
| 4 | Plastic Cover, Top Entry Large Clamp |
| 5 | Metal Cover, Side Entry |
| 6 | Metal Cover, Top Entry |
| 7 | Metal Cover, Large Clamp |

| Cover Size | Fits Connector |
|------------|---|
| 12 | 516 Series 120 Pin |
| 20 | 516 Series 20 Pin and 519 Series 14 Pin |
| 38 | 516 Series 38 Pin and 519 Series 36 Pin |
| 56 | 516 Series 56 Pin |
| 90 | 516 Series 90 Pin |

Ordering Code Notes

- 1) Plastic covers with large clamps are only available for the 38 and 56 pin size connectors.
- 2) Metal covers with side entry may be converted to top entry by removing side plate and changing clamp orientation.

FEATURES

- Available in Metal (Die-Cast Zinc Finished with Grey Enamel Paint) or Plastic (Green Polycarbonate) Material
- Covers with Top or Side Entry Cable Clamp. Orientation of Clamp on Metal Covers may be changed by the Customer
- Versatile Metal Cover Design permits Assembly or Disassembly after Cabling is Complete
- Screws for Securing Cover to 516 or 519 Series Connectors Supplied

METAL COVERS

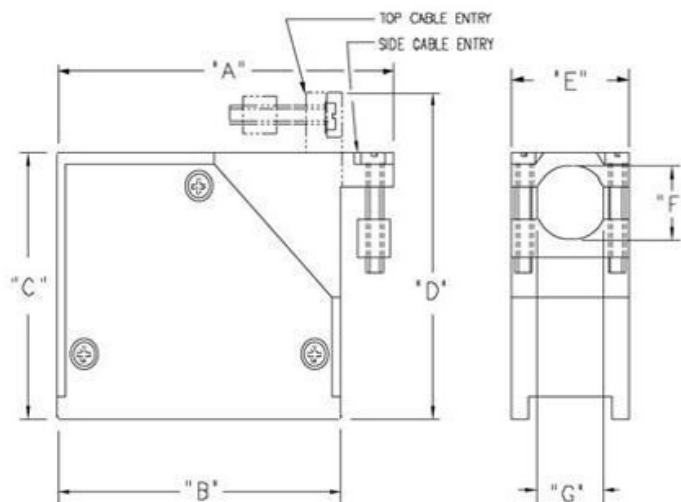

NEW COVER DESIGN (AVAILABLE SOON) WILL ELIMINATE 3 SCREWS FOR SIDE TO SIMPLIFY ASSEMBLY, DISASSEMBLY AND CLAMP ORIENTATION CHANGES

SCREWS FOR SECURING THE COVER TO THE CONNECTOR ARE SUPPLIED BY EDAC.

PLASTIC COVERS

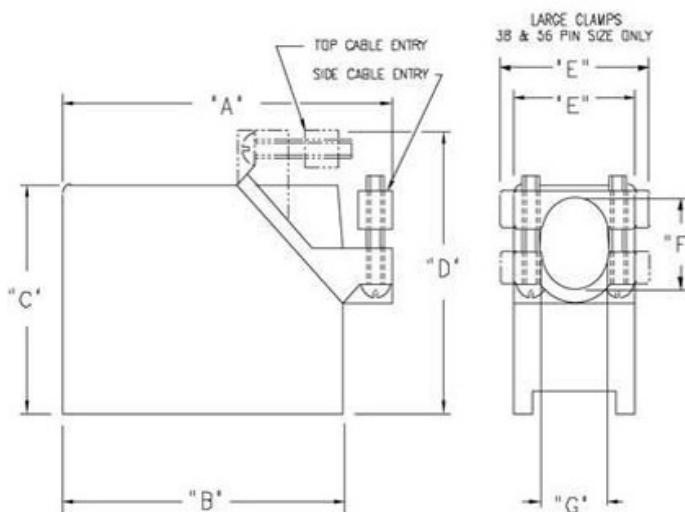

| COVER FOR CONNECTOR | COVER MATERIAL | CLAMP SIZE | "A" | | "B" | | "C" | | "D" | | "E" | | "F" | | "G" | |
|---------------------|----------------|------------|-------|---------|-------|---------|-------|---------|-------|---------|-------|---------|------|---------|-------|---------|
| | | | Inch | (mm) | Inch | (mm) | Inch | (mm) | Inch | (mm) | Inch | (mm) | Inch | (mm) | Inch | (mm) |
| 20 Pin | Plastic | Standard | 1.605 | (40.77) | 1.325 | (33.66) | .906 | (23.01) | 1.190 | (30.23) | .715 | (18.16) | .450 | (11.43) | .450 | (11.43) |
| 20 Pin | Metal | Standard | 1.539 | (39.09) | 1.325 | (33.66) | .906 | (23.01) | 1.120 | (28.45) | .686 | (17.42) | .446 | (11.33) | .490 | (12.45) |
| 38 Pin | Plastic | Standard | 2.460 | (62.48) | 2.010 | (51.05) | 1.530 | (38.86) | 1.985 | (50.42) | .910 | (23.11) | .650 | (16.51) | .500 | (12.70) |
| 38 Pin | Plastic | Large | 2.460 | (62.48) | 2.010 | (51.05) | 1.530 | (38.86) | 1.985 | (50.42) | 1.110 | (28.19) | .650 | (16.51) | .608 | (15.44) |
| 38 Pin | Metal | Standard | 2.206 | (56.03) | 2.006 | (50.95) | 1.566 | (39.78) | 1.766 | (44.86) | .875 | (22.23) | .720 | (18.29) | .575 | (14.61) |
| 56 Pin | Plastic | Standard | 3.052 | (77.52) | 2.602 | (66.09) | 1.530 | (38.86) | 1.985 | (50.42) | .910 | (23.11) | .650 | (16.51) | .500 | (12.70) |
| 56 Pin | Plastic | Large | 3.052 | (77.52) | 2.602 | (66.09) | 1.530 | (38.86) | 1.985 | (50.42) | 1.110 | (28.19) | .650 | (16.51) | .608 | (15.44) |
| 56 Pin | Metal | Standard | 2.802 | (71.17) | 2.602 | (66.09) | 1.566 | (39.78) | 1.766 | (44.86) | .875 | (22.23) | .720 | (18.29) | .575 | (14.61) |
| 90 Pin | Plastic | Standard | 3.124 | (79.35) | 2.718 | (69.04) | 1.775 | (45.09) | 2.181 | (55.40) | 1.250 | (31.75) | .800 | (20.32) | .800 | (20.32) |
| 90 Pin | Metal | Standard | 3.118 | (79.20) | 2.718 | (69.04) | 1.775 | (45.09) | 2.175 | (55.25) | 1.234 | (31.34) | .880 | (22.35) | .900 | (22.86) |
| 120 Pin | Plastic | Standard | 3.156 | (80.16) | 2.750 | (69.85) | 2.020 | (51.31) | 2.426 | (61.62) | 1.530 | (38.86) | .800 | (20.32) | 1.080 | (27.43) |
| 120 Pin | Metal | Standard | 3.175 | (80.65) | 2.750 | (69.85) | 2.020 | (51.31) | 2.445 | (62.10) | 1.531 | (38.89) | .890 | (22.61) | 1.080 | (27.43) |

516 SERIES RACK & PANEL CONNECTOR

Plug and Receptacle with EMI / REI Shielding

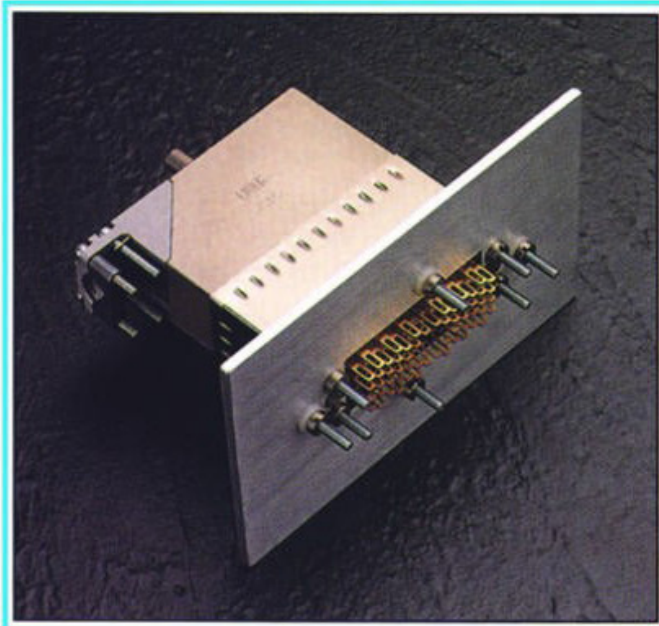

FEATURES

- UL Recognized
- .150 (3.81) Contact Spacing x .130 (3.30) or .150 (3.81) Row Spacing with Staggered Grid
- Plug and Receptacle in 20, 38, 56, 90 or 120 Contact Sizes
- Edacon Hermaphroditic Contact Mating Design
- Contact Termination Options include Crimp, P.C. Tail, Wire Hole, Wire Wrap and Tapet Tail
- Mating and Unmating Simplified with use of Actuating Screws
- Optional Covers with Cable Clamp Available Material for all Connector Sizes with Side or Top Cable Entry
- Versatile Cover Design permits Assembly or Dis-assembly After Cabling is Complete plus Cable Entry Style Flexibility
- Actuating Screws, Locknuts, Polarizing Hardware, Covers and Contacts Suitable for either Plug or Receptacle
- Polarizing Hardware Adjustable for 288 Mating Combinations
- Tools Available for Contact Installation, Removal and Crimping and Polarizing Changes
- EMI / RFI Shielding Hardware

SPECIFICATIONS

- ◆ Insulator Material: Diallyl Phthalate or Thermoplastic Polyester, UL 94V-0, Colour: Green, or Polycarbonate, Colour: Grey
- ◆ **Contact Material: Copper Alloy**
- ◆ Contact Plating: Gold over Nickel for Entire Contact
- ◆ Cover Material: Die-Cast Zinc
- ◆ Current Rating: 8.5 Amperes
- ◆ Contact Resistance: 10 Milliohms Maximum
- ◆ Dielectric Withstanding Voltage: 2000 V AC rms at Sea Level
- ◆ Insulation Resistance: 5000 Megohms Minimum
- ◆ Operating Temperature: -65 to +125 Degrees C
- ◆ Insertion and Withdrawal Force: 2 to 16 oz (0.56 to 4.45 N) per Contact Position
- ◆ Shielded Covers available with unpainted finish only

516 SERIES ORDERING CODE

Example Part Number **516 - 038 - 500 - B 2 1 2**

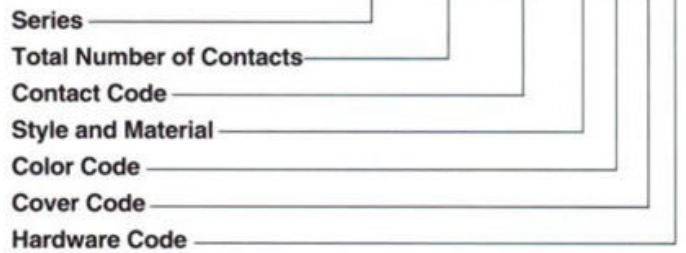

Note: If no color code is indicated, standard colors will be supplied

Series 516

Total Number of Contacts

020, 038, 056, 090 or 120

| Contact Code ^{1,2} | Description & Tail Size | Tail Length "G" |
|-----------------------------|-------------------------------------|-----------------|
| 000 | No Contacts Assembled | — |
| 500 | Wire Hole .110 x .024 (2.79 x 0.61) | .245 (6.22) |
| 501 | Taper Tail | .245 (6.22) |
| 520 | P.C. Tail .025 x .024 (0.64 x 0.61) | .215 (5.46) |
| 540 | Wire Wrap .050 x .024 (1.27 x 0.61) | .600 (15.24) |
| 541 | Wire Wrap .026 x .024 (0.66 x 0.61) | .620 (15.75) |
| 542 | Wire Wrap .050 x .024 (1.27 x 0.61) | .790 (20.07) |

| Style and Material ³ | Style | Insulator Material |
|---------------------------------|------------|-------------------------|
| 1 | Plug | Green Diallyl Phthalate |
| 2 | Receptacle | Green Diallyl Phthalate |
| 3 | Plug | Grey Polycarbonate |
| 4 | Receptacle | Grey Polycarbonate |
| 5 | Plug | Green Polyester |
| 6 | Receptacle | Green Polyester |

| Cover Code ^{4,5,6,7} | Description |
|-------------------------------|----------------------------------|
| 7 | Shielded Metal Cover, Side Entry |
| 8 | Shielded Metal Cover, Top Entry |

| Hardware Code ⁸ | Description |
|----------------------------|---|
| 0 | No Hardware Assembled |
| 1 | Actuating Screw and Polarizing Hardware |
| 2 | Locknut and Polarizing Hardware |
| 5 | Actuating Screw with No Polarizing Hardware |
| 6 | Locknut with No Polarizing Hardware |

Ordering Code Notes

- 1) Crimp contacts are also available for the 516 series connectors. Contacts may be ordered separately for pre-wired or select position assembly.

| Part Number | Description | Silhouette |
|-------------|--------------------------------|------------|
| 516-290-500 | Wire Hole | |
| 516-290-501 | Taper Tail | |
| 516-290-520 | P.C. Tail | |
| 516-290-540 | Wire Wrap | |
| 516-290-541 | Wire Wrap | |
| 516-290-542 | Wire Wrap | |
| 516-290-590 | Crimp - Loose | |
| 516-290-591 | Crimp - 1800 Contacts per reel | |

Continued on next page

RACK & PANEL CONNECTORS SERIES 516

EMI / RFI Shielded Covers

STANDARD EDAC 516 SERIES PLUG OR RECEPTACLE CONNECTOR WITH BRAID GROUNDING CLAMP ASSEMBLY

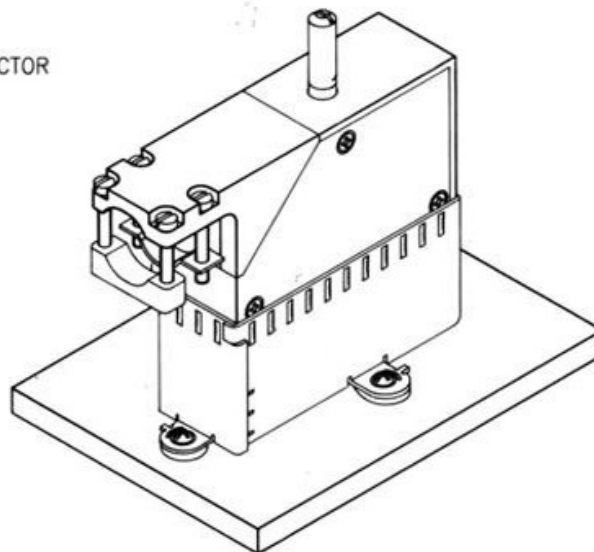
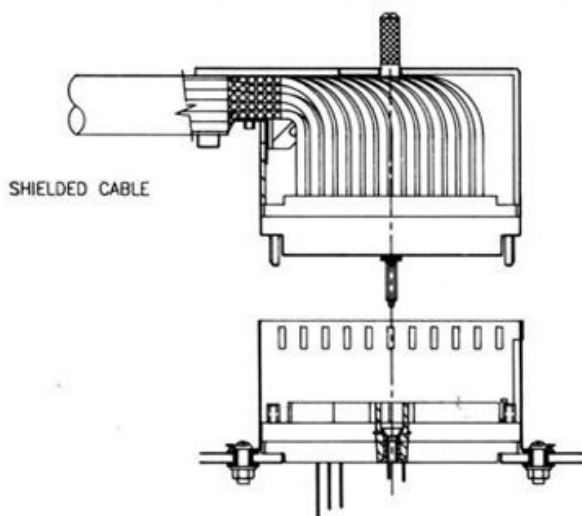

PANEL CUT-OUT AND SHIELD MOUNTING HOLES
PANEL CUT AWAY TO CLEAR CONNECTOR

STANDARD EDAC 516 SERIES PLUG OR RECEPTACLE CONNECTOR WITH SHIELDING HARDWARE IN PLACE

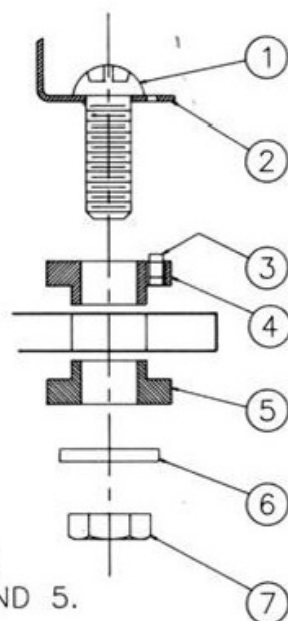
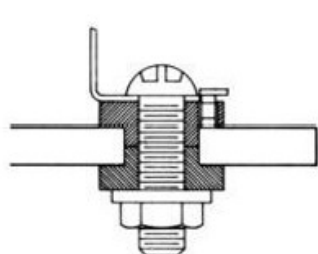

CAPACITOR CONNECTION TO GROUND PLANE

FOR NON CAPACITIVE CONNECTION TO GROUND REMOVE DETAILS 3 ,4 AND 5.

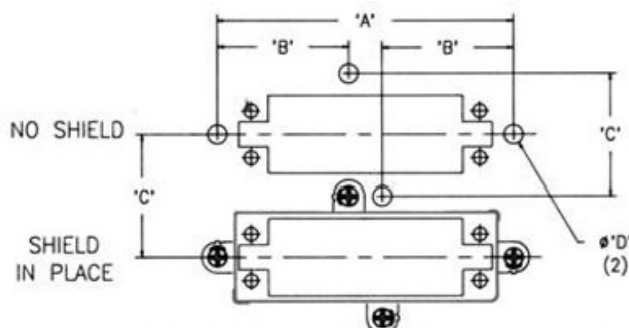

| DETAIL No | DESCRIPTION |
|-----------|---------------------------|
| 1 | #4-40 P.H.C.S. X 3/4 LONG |
| 2 | PANEL SHIELD |
| 3 | SMD CAPACITOR |
| 4 | CAPACITOR RETAINER |
| 5 | INSULATING SPACER |
| 6 | #4- FLAT WASHER |
| 7 | #4-40 HEX NUT |

| NUMBER OF CONTACTS | "A" | | "B" | | "C" | | "D" | |
|--------------------|-------|---------|-------|---------|-------|---------|------|--------|
| | inch | (mm) | inch | (mm) | inch | (mm) | inch | (mm) |
| 20 | 1.679 | (42.65) | .673 | (17.09) | 1.061 | (26.95) | .190 | (4.83) |
| 38 | 2.360 | (59.94) | 1.014 | (25.75) | 1.220 | (31.01) | .190 | (4.83) |
| 56 | 2.956 | (75.08) | 1.312 | (33.52) | 1.220 | (31.01) | .190 | (4.83) |
| 90 | 3.072 | (78.05) | 1.370 | (34.80) | 1.580 | (40.13) | .190 | (4.83) |
| 120 | 3.104 | (78.84) | 1.386 | (35.20) | 1.877 | (47.68) | .190 | (4.83) |

516 SERIES RACK & PANEL CONNECTOR

Mounting Information

RACK AND PANEL CONNECTORS

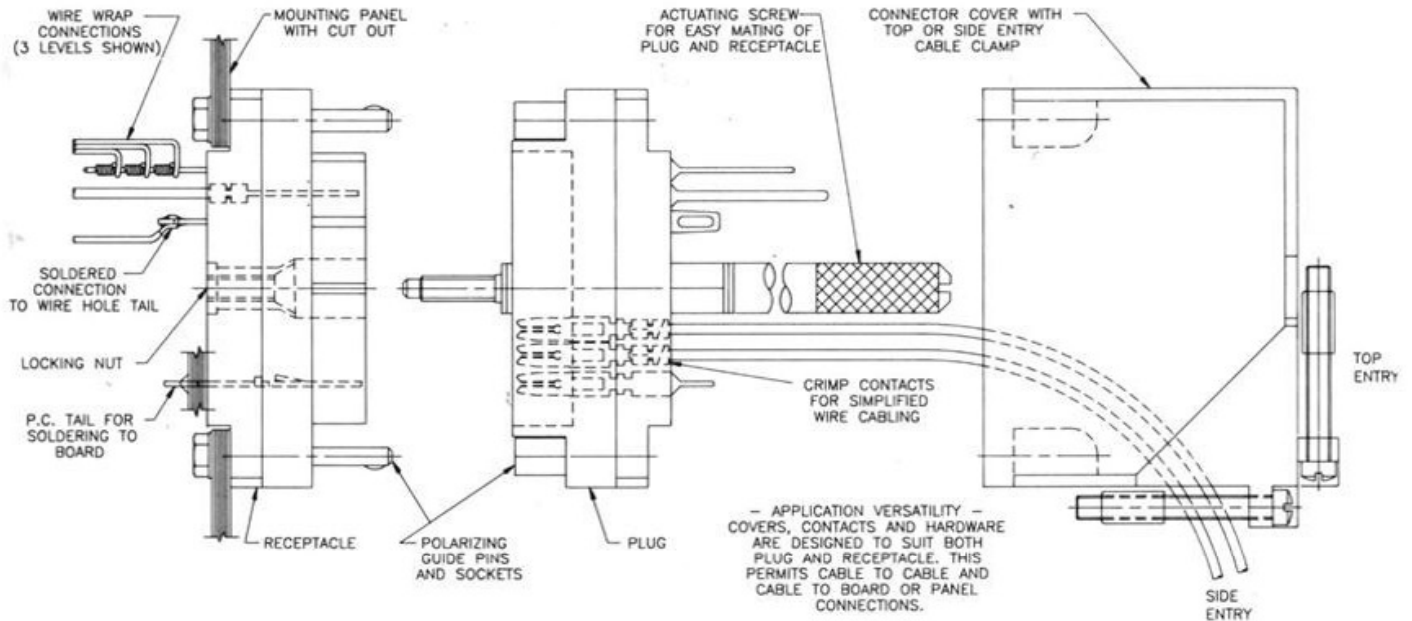

516 / 519 SERIES CONNECTOR PANEL MOUNTING CUT-OUT

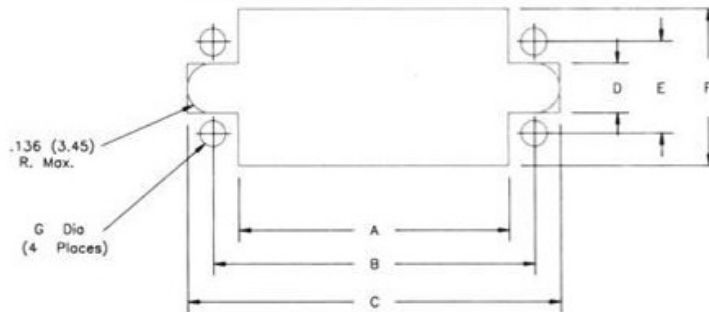

516 SERIES CONNECTOR CUT OUTS

| CONNECTOR SIZE | A | B | C | D | E | F | G Dia |
|----------------|---------------|---------------|---------------|-------------|--------------|---------------|-------------|
| 20 pin | .960 (24.38) | 1.126 (28.6) | 1.270 (32.26) | .260 (6.60) | .410 (10.41) | .640 (16.26) | .104 (2.64) |
| 38 pin | 1.420 (36.07) | 1.688 (42.87) | 1.958 (49.73) | .260 (6.60) | .468 (11.89) | .816 (20.73) | .136 (3.45) |
| 56 pin | 1.940 (49.28) | 2.280 (57.91) | 2.550 (64.77) | .260 (6.60) | .468 (11.89) | .816 (20.73) | .136 (3.45) |
| 90 pin | 2.050 (52.07) | 2.282 (57.96) | 2.675 (67.95) | .300 (7.62) | .765 (19.43) | 1.120 (36.07) | .136 (3.45) |
| 120 pin | 2.050 (52.07) | 2.375 (60.32) | 2.675 (67.95) | .300 (7.62) | .875 (22.22) | 1.420 (36.07) | .156 (3.96) |

519 SERIES CONNECTOR CUT OUTS

| CONNECTOR SIZE | A | B | C | D | E | F | G Dia |
|----------------|---------------|---------------|---------------|-------------|--------------|--------------|-------------|
| 14 pin | .960 (24.38) | 1.126 (28.6) | 1.270 (32.26) | .260 (6.60) | .410 (10.41) | .640 (16.26) | .104 (2.64) |
| 36 pin | 1.420 (36.07) | 1.688 (42.87) | 1.958 (49.73) | .260 (6.60) | .468 (11.89) | .816 (20.73) | .136 (3.45) |

516 SERIES RACK & PANEL CONNECTORS

Ordering Information

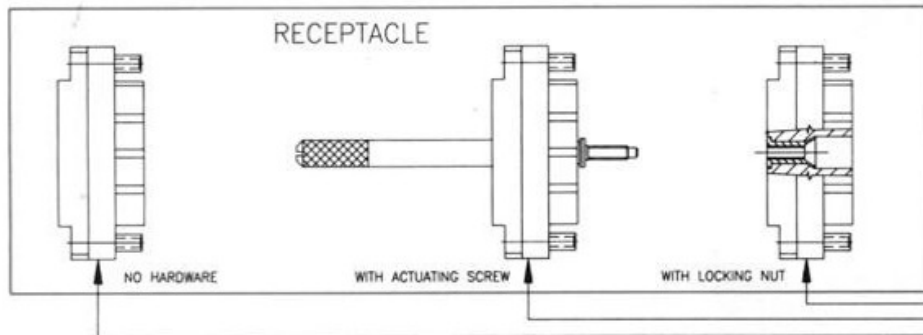
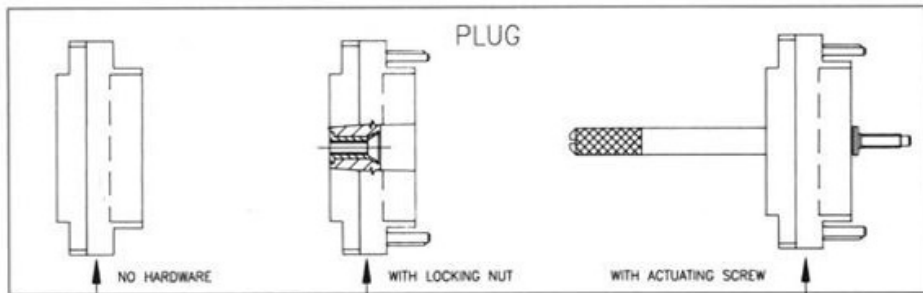

ORDERING CODE

516 056 540 102

SERIES
NUMBER OF CONTACTS
CONTACT CODE

| DAP CODE | STYLE | DESCRIPTION | POLYCARB CODE |
|----------|--|-----------------|---------------|
| 101 | P L U G | ACTUATING SCREW | 301 |
| 102 | | LOCKING NUT | 302 |
| 100 | | NO HARDWARE | 300 |
| 202 | R E C E P T A C L E | ACTUATING SCREW | 402 |
| 201 | | LOCKING NUT | 401 |
| 200 | | NO HARDWARE | 400 |

POLYCARBONATE CONNECTORS AVAILABLE IN 20,38,56 AND 90 PINS SIZES ONLY

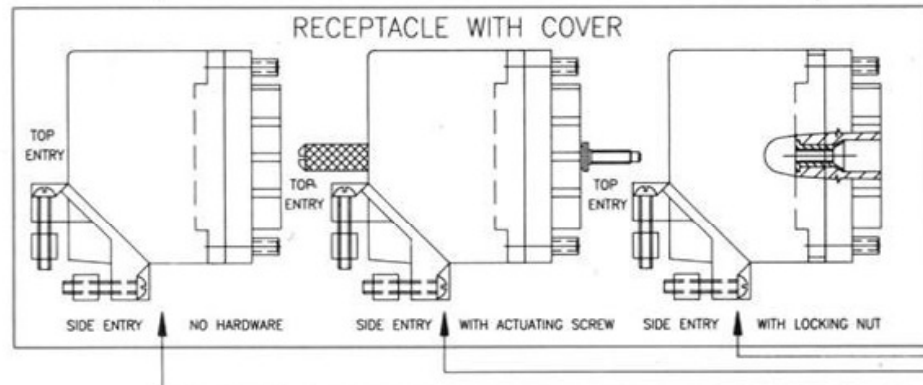
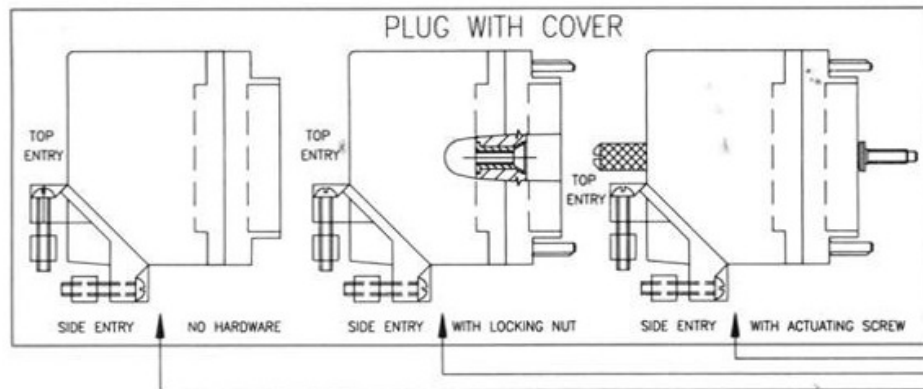

| CODE REG. CLAMP | STYLE | DESCRIPTION | CODE LARGE CLAMP | |
|-----------------|-------------------------|--|------------------------------|-----|
| 111 | P L U G | ACTUATING SCREW, TOP ENTRY | 131 | |
| 121 | | ACTUATING SCREW, SIDE ENTRY | 141 | |
| 151 | | ACTUATING SCREW, METAL COVER | 151 | |
| 112 | | LOCKING, NUT TOP ENTRY | 132 | |
| 122 | | LOCKING, NUT SIDE ENTRY | 142 | |
| 152 | | LOCKING, NUT METAL COVER | 152 | |
| 110 | | NO HARDWARE, TOP ENTRY | 152 | |
| 120 | | NO HARDWARE, SIDE ENTRY | 130 | |
| 150 | | NO HARDWARE METAL COVER | 150 | |
| 211 | | R E C E P T A C L E | ACTUATING SCREW, TOP ENTRY | 231 |
| 221 | | | ACTUATING SCREW, SIDE ENTRY | 241 |
| 251 | | | ACTUATING SCREW, METAL COVER | 251 |
| 212 | | | LOCKING, NUT TOP ENTRY | 232 |
| 222 | | | LOCKING, NUT SIDE ENTRY | 242 |
| 252 | | | LOCKING, NUT METAL COVER | 252 |
| 210 | NO HARDWARE, TOP ENTRY | | 230 | |
| 220 | NO HARDWARE, SIDE ENTRY | | 240 | |
| 250 | NO HARDWARE METAL COVER | | 250 | |

519 SERIES RACK & PANEL CONNECTOR

Plug and Receptacle



FEATURES

- .150 (3.81) Contact Spacing x .150 (3.81) Row Spacing Suitable For Automatic Wire Wrapping
- Plug and Receptacle in 14 or 36 Contact Sizes
- Edacon Hermaphroditic Contact Mating Design
- Contact Termination Options include Crimp, P.C. Tail, Wire Hole and Wire Wrap
- Mating and Unmating Simplified with use of Actuating Screws
- Optional Covers with Side or Top Entry Cable Clamp in Plastic or Metal Material Available for all Connector Sizes
- Versatile Metal Cover Design permits Assembly or Disassembly After Cabling is Complete plus Cable Entry Style Flexibility
- Actuating Screws, Locknuts, Polarizing Hardware, Covers and Contacts Suitable for either Plug or Receptacle
- Polarizing Hardware Adjustable for 288 Mating Combinations
- Tools Available for Contact Installation, Removal and Crimping and Polarizing Changes

SPECIFICATIONS

- ◆ Insulator Material: Polycarbonate, Colour: Grey
- ◆ **Contact Material: Copper Alloy**
- ◆ Contact Plating: Gold over Nickel for Entire Contact
- ◆ Cover Material: Polycarbonate, Colour: Green, or Die-Cast Zinc, Finished with Grey Enamel Paint
- ◆ For Additional Specifications, Crimp Characteristics and Polarizing Codes Refer to 516 Series

519 SERIES ORDERING CODE

Example Part Number **519 - 036 - 500 - 301**

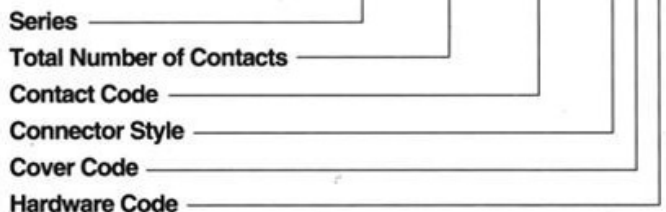

Series 519

Total Number of Contacts

014, 036

Contact Code

See 516 Series for Available Contact Options, "G" Dimension and Information Regarding Ordering Contacts Separately

Connector Style

Style

3

Plug

4

Receptacle

Cover Code ^{1, 2, 3, 4}

Description

0

No Cover Assembled

1

Plastic Cover, Top Entry Standard Clamp

2

Plastic Cover, Side Entry Standard Clamp

3

Plastic Cover, Top Entry Large Clamp

4

Plastic Cover, Side Entry Large Clamp

5

Metal Cover, Side Entry

6

Metal Cover, Top Entry

Hardware Code ⁵

Description

0

No Hardware Assembled

1

Actuating Screw and Polarizing Hardware

2

Locknut and Polarizing Hardware

5

Actuating Screw with No Polarizing Hardware

6

Locknut with No Polarizing Hardware

Ordering Code Notes

- 1) The 14 pin connector cover will not accept the length of the wire wrap contacts.
- 2) Plastic covers with large clamps are only available for the 36 pin size connectors.
- 3) Metal covers with side entry may be converted to top entry by removing side plate and changing clamp orientation.
- 4) Covers may be ordered separately. Refer to page 88.
- 5) Insulator design prevents improper mating of individual plug and receptacle. Polarizing hardware enables specific plug and receptacle mating combinations.

RACK & PANEL CONNECTOR SERIES 519

Plug and Receptacle

CONNECTOR MATING FACE VIEWS

DIMENSIONS INDICATED FOR EACH SIZE APPLY TO BOTH PLUG AND RECEPTACLE

14 PIN PLUG

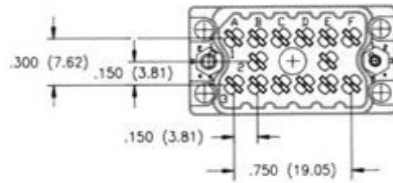

14 PIN RECEPTACLE

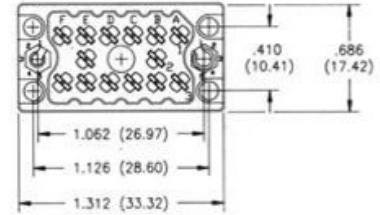

36 PIN PLUG

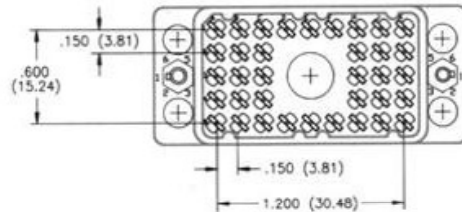

36 PIN RECEPTACLE

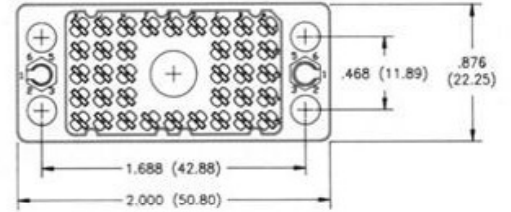

TYPICAL PLUG WITH ACTUATING SCREW AND POLARIZING GUIDE PINS

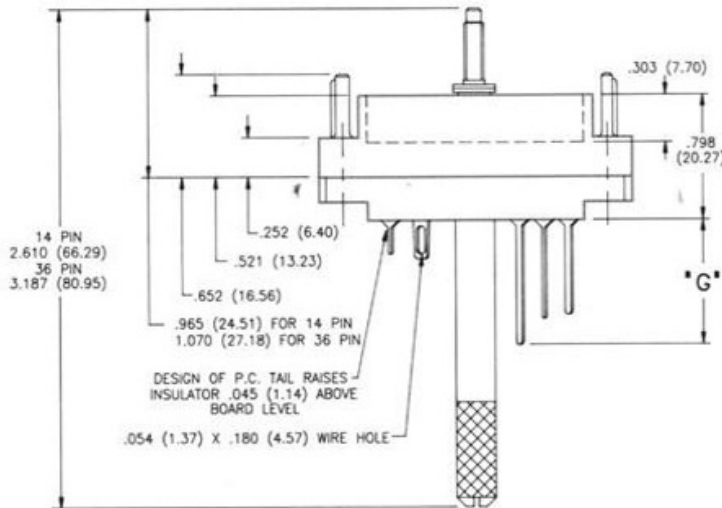

TYPICAL RECEPTACLE WITH LOCKNUT AND POLARIZING SOCKETS

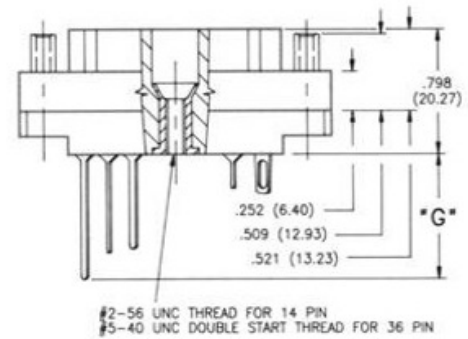

TYPICAL PLUG WITH ACTUATING SCREW, POLARIZING GUIDE PINS AND COVER

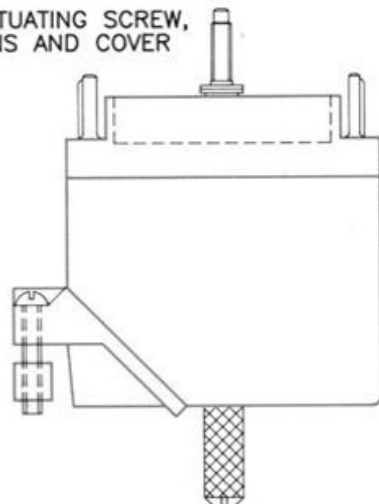

TYPICAL RECEPTACLE WITH LOCKNUT, POLARIZING SOCKETS AND COVER

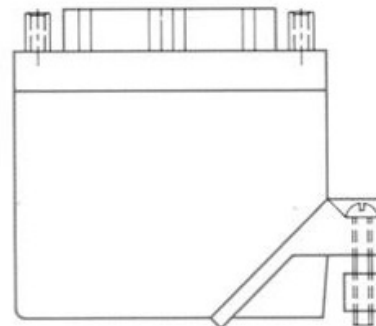

NOTE: PLASTIC POLARIZING GUIDE PINS AND SOCKETS (AVAILABLE SOON) WILL BE COLOUR CODED TO VISUALLY ASSIST CONNECTOR MATING. POLARIZATION CHANGES WILL ALSO BE SIMPLIFIED AS THEY SNAP FIRMLY INTO POSITION AND CAN BE REPLACED USING NEEDLENOSE PLIERS.

556 SERIES EDACON CONNECTOR

Plug and Receptacle

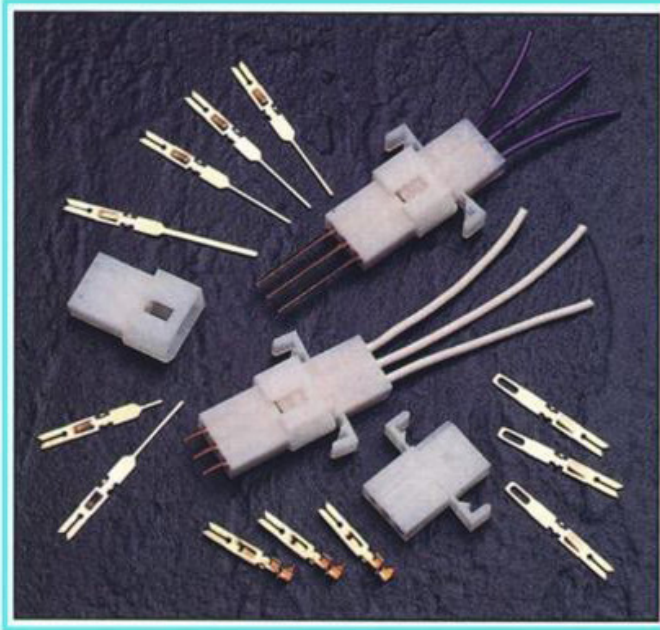

FEATURES

- UL Recognized
- .156 (3.96) Contact Spacing
- Plug and Receptacle in 3, 4, or 6 Contact Sizes
- Edacon Hermaphroditic Contact Mating Design
- Contact Termination Options include Crimp, P.C. Tail, Wire Hole, Wire Wrap and Taper Tail
- Tools Available for Contact Installation, Removal and Crimping

SPECIFICATIONS

- Circuit board substrate available in 94V-0
- Insulator Material: White Nylon
- **Contact Material: Copper Alloy**
- Contact Plating: Gold over Nickel for Entire Contact
- Current Rating: 8.5 Amperes
- Contact Resistance: 10 Milliohms Maximum
- Dielectric Withstanding Voltage: 2000 V AC rms at Sea Level
- Insulation Resistance: 5000 Megohms Minimum
- Operating Temperature: -65 to +105 Degrees C
- Insertion and Withdrawal Force: 2 to 16 oz (0.56 to 4.45 N) per Contact Position

556 SERIES ORDERING CODE

Example Part Number **556 - 003 - 500 - 102**

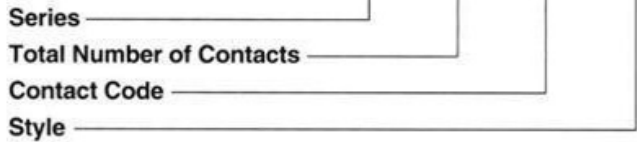

Series 556

Total Number of Contacts
003

| Contact Code ^{1,2} | Description & Tail Size | Tail Length "G" |
|-----------------------------|-------------------------------------|-----------------|
| 000 | No Contacts Assembled | — |
| 500 | Wire Hole .110 x .024 (2.79 x 0.61) | .245 (6.22) |
| 501 | Taper Tail | .245 (6.22) |
| 520 | P.C. Tail .025 x .024 (0.64 x 0.61) | .215 (5.46) |
| 540 | Wire Wrap .050 x .024 (1.27 x 0.61) | .600 (15.24) |
| 541 | Wire Wrap .026 x .024 (0.66 x 0.61) | .620 (15.75) |
| 542 | Wire Wrap .050 x .024 (1.27 x 0.61) | .790 (20.07) |

Style and Material³

| Style | Style |
|-------|---------------------------|
| 101 | Plug |
| 201 | Receptacle |
| 102 | Plug with Panel Retention |

Ordering Code Notes

- 1) Crimp contacts are also available for the 556 series connectors. Contacts may be ordered separately for pre-wired or select position assembly.

| Part Number | Description | Silhouette |
|-------------|--------------------------------|------------|
| 516-290-500 | Wire Hole | |
| 516-290-501 | Taper Tail | |
| 516-290-520 | P.C. Tail | |
| 516-290-540 | Wire Wrap | |
| 516-290-541 | Wire Wrap | |
| 516-290-542 | Wire Wrap | |
| 516-290-590 | Crimp - Loose | |
| 516-290-591 | Crimp - 1800 Contacts per reel | |

- 2) For contact installation, removal and crimping tools, refer to page 72.
- 3) Insulator design prevents improper mating of individual plug and receptacle.

EDACON CONNECTOR SERIES 556

Plug and Receptacle

MALE CONNECTOR
(Hermaphroditic contacts)

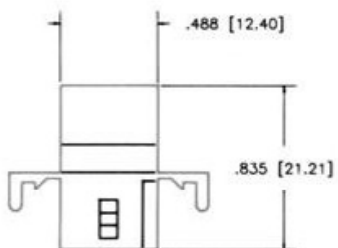
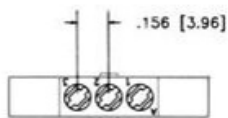

FEMALE CONNECTOR
(Hermaphroditic contacts)

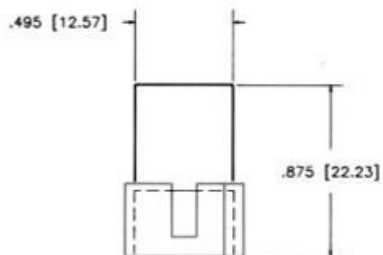
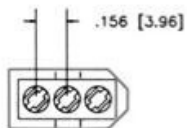

**RECOMMENDED
PANEL OPENING**
(If Desired)

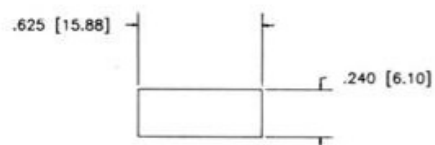

**RECOMMENDED
BOARD LAYOUT**

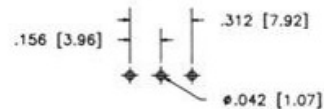

CONNECTOR MATING FACE VIEWS

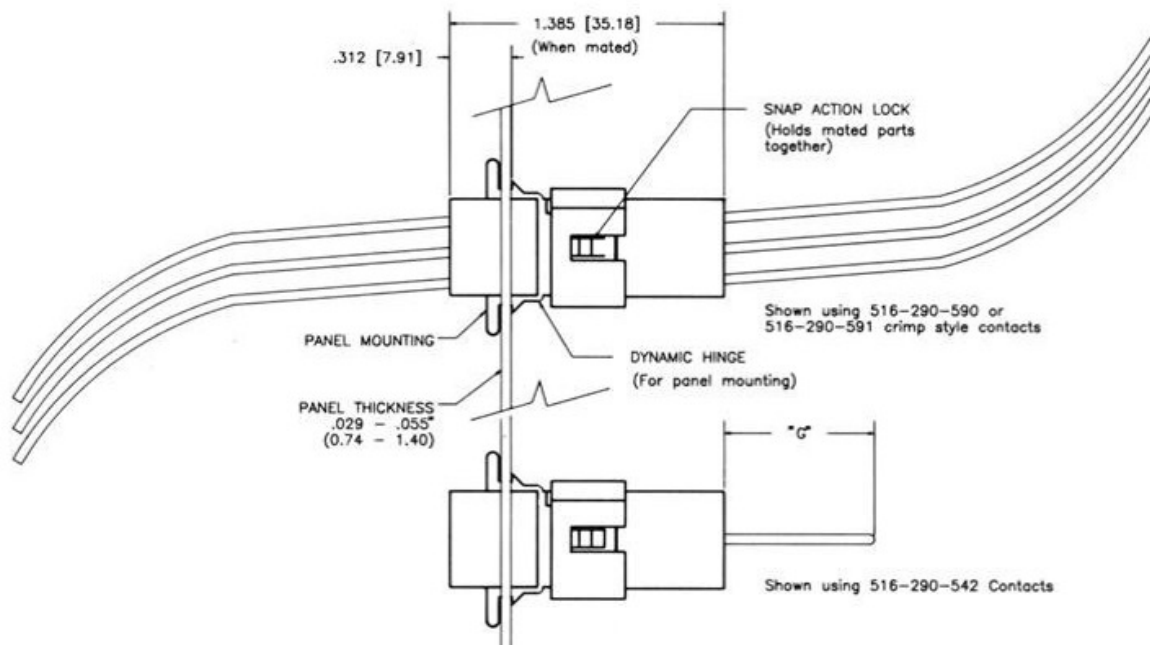
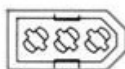
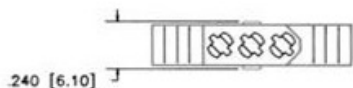



Компания «ЭлектроПласт» предлагает заключение долгосрочных отношений при поставках импортных электронных компонентов на взаимовыгодных условиях!

Наши преимущества:

- Оперативные поставки широкого спектра электронных компонентов отечественного и импортного производства напрямую от производителей и с крупнейших мировых складов;
- Поставка более 17-ти миллионов наименований электронных компонентов;
- Поставка сложных, дефицитных, либо снятых с производства позиций;
- Оперативные сроки поставки под заказ (от 5 рабочих дней);
- Экспресс доставка в любую точку России;
- Техническая поддержка проекта, помощь в подборе аналогов, поставка прототипов;
- Система менеджмента качества сертифицирована по Международному стандарту ISO 9001;
- Лицензия ФСБ на осуществление работ с использованием сведений, составляющих государственную тайну;
- Поставка специализированных компонентов (Xilinx, Altera, Analog Devices, Intersil, Interpoint, Microsemi, Aeroflex, Peregrine, Syfer, Eurofarad, Texas Instrument, Miteq, Cobham, E2V, MA-COM, Hittite, Mini-Circuits, General Dynamics и др.);

Помимо этого, одним из направлений компании «ЭлектроПласт» является направление «Источники питания». Мы предлагаем Вам помощь Конструкторского отдела:

- Подбор оптимального решения, техническое обоснование при выборе компонента;
- Подбор аналогов;
- Консультации по применению компонента;
- Поставка образцов и прототипов;
- Техническая поддержка проекта;
- Защита от снятия компонента с производства.



Как с нами связаться

Телефон: 8 (812) 309 58 32 (многоканальный)

Факс: 8 (812) 320-02-42

Электронная почта: org@eplast1.ru

Адрес: 198099, г. Санкт-Петербург, ул. Калинина, дом 2, корпус 4, литера А.