High Efficiency Small Packaged Step-up DC/DC Converter

NO.EA-317-160509

OUTLINE

The RP402x is a CMOS-based high efficiency step-up DC/DC converter with synchronous rectifier. The device can start up with low voltage of typically 0.7 V which is ideal for the applications powered by either one-cell or two-cell alkaline, nickel-metal-hydride (NiMH) or one-cell Lithium-ion (Li+) batteries.

Internally, the RP402x consists of an oscillator, a reference voltage unit with soft start, a chip enable circuit, an error amplifier, phase compensation circuits, a slope circuit, a PWM control circuit, a start-up circuit, a PWM/VFM mode control circuit, internal switches and protection circuits.

The RP402x is employing synchronous rectification for improving the efficiency or rectification by replacing diodes with built-in switching transistors. Using synchronous rectification not only increases circuit performance but also allows a design to reduce parts count.

The RP402x is available in either internally fixed output voltage type or adjustable output voltage type. The RP402xxxx is the internally fixed output voltage type. The RP402x00xx is the adjustable output voltage type, which allows output voltages that range from 1.8 V to 5.5 V via an external divider resistor.

The RP402x provides the forced PWM control and the PWM/VFM auto switching control. Either one of these can be selected by inputting a signal to the MODE pin. The forced PWM control switches at fixed frequency rate in low output current in order to reduce noise. Likewise, the PWM/VFM auto switching control automatically switches from PWM mode to VFM mode in low output current in order to achieve high efficiency. The RP402N is available in the PWM/VFM auto switching control. However, the RP402N is also available in the forced PWM control as a custom-designed IC^{*1}.

The RP402x has a soft-start time of typically 0.5 ms.

The RP402x features the complete output disconnect shutdown option and the input-to-output bypass shutdown option. The RP402xxxxA/ B/ E/ F incorporates the complete output disconnect shutdown option, which allows the output to be disconnected from the input. The RP402xxxxC/ D/ G/ H incorporates the input-to-output bypass shutdown option, which allows the output to be connected to the input.

The RP402x is protected against damage by a short-current protection, an over-voltage lockout, an over voltage protection, an anti-ringing switch and a latch-type protection. An anti-ringing switch prevents the occurrence of noise when an inductor current reaches a discontinuous mode. The latch-type protection can be released by switching the CE pin from high to low.

The RP402x is offered in a compact 5-pin SOT23-5^{*1} package or a 8-pin DFN(PLP)2020-8 package.

^{*1} As for the custom-designed IC, please contact our sales representatives.

FEATURES

- Low Voltage Start-up Typ. 0.7 V
- Input Voltage Range..... Fixed Output Voltage Type: 0.6 V to 4.8 V
Adjustable Output Voltage Type: 0.6 V to 4.6 V
- High Efficiency 94% (100 mA/ 5.0 V, $V_{IN} = 3.6$ V, 25°C)
90% (1 mA/ 5.0 V, $V_{IN} = 3.6$ V, 25°C)
- Output Current 800 mA: $V_{IN} = 3.6$ V, $V_{OUT} = 5.0$ V
- L_X Driver ON Resistance NMOS/ PMOS: 0.20 Ω ($V_{OUT} = 5.0$ V, 25°C)
- PWM Oscillator Frequency 1.2 MHz (Normal PWM), 1.0 MHz (Forced PWM)
- Output Voltage Range..... Fixed Output Voltage Type: 1.8 V to 5.5 V, 0.1 V step
Adjustable Output Voltage Type: 1.8 V to 5.5 V (recommended)
- OVLO Detector Threshold Typ. 5.1 V
- OVP Detector Threshold Typ. 6.0 V
- L_X Peak Current Limit Typ. 1.5 A
- Latch Protection Delay Time..... Typ. 3.3 ms (RP402Kxx1x, RP402Nxx1x)
Typ. 4.1 ms (RP402Kxx2x)
- Soft-start Time Typ. 0.5 ms
- EMI Suppression (Built-in Anti-ringing Switch) (RP402Kxx1x, RP402Nxx1x)
- Voltage Regulation at $V_{IN} > V_{OUT}$
- Zero Input Complete Shutdown at $V_{IN} = 0$ V
- Input-to-Output Bypass Shutdown Option at CE = L (RP402xxxxC/ D/ G/ H)
- Ceramic Capacitor Capable
- Package DFN(PLP)2020-8, SOT23-5

APPLICATIONS

- MP3 Players, PDA
- Digital Still Cameras
- LCD Bias Supplies
- Portable Blood Pressure Meter
- Wireless Handset
- GPS
- USB-OTG
- HDMI

SELECTION GUIDE

The package type, the set output voltage, the PWM control type, the shutdown option, the MODE pin option, and the latch function are user-selectable options.

Selection Guide

Product Name	Package	Quantity per Reel	Pb Free	Halogen Free
RP402Kxx#-\$-TR	DFN(PLP)2020-8	5,000 pcs	Yes	Yes
RP402Nxx#-\$-TR-FE	SOT-23-5	3,000 pcs	Yes	Yes

xx: Specify the set output voltage (V_{SET}).

00: Adjustable Output Voltage Type (1.8 V to 5.5 V, recommended voltage range)

xx: Fixed Output Voltage Type (1.8 V to 5.5 V, adjustable in 0.1 V step)

Please note: SOT-23-5 package is only available with fixed output voltage type.

#: Specify the PWM control type.

1: Normal PWM operation

2: Forced PWM operation

\$: Specify the combination of the shutdown option, the MODE pin option and the latch function.

Version	Shutdown Options at CE = L	MODE Pin	Latch Function
A	Complete Output Disconnect	Yes	Yes
B	Complete Output Disconnect	Yes	No
C	Input-to-Output Bypass	Yes	Yes
D	Input-to-Output Bypass	Yes	No
E	Complete Output Disconnect	No	Yes
F	Complete Output Disconnect	No	No
G	Input-to-Output Bypass	No	Yes
H	Input-to-Output Bypass	No	No

Please refer to *Selection Guide Table* on the next page for detailed information.

RP402x

NO.EA-317-160509

Selection Guide Table

Package	Output Voltage Type	#\$	Shutdown Option at CE = L	MODE Pin Function		PWM Controlling Method	Latch Function
				MODE Pin	Power Controlling Method		
DFN(PLP)2020-8	Fixed Output Voltage Type	1A	Complete Output Disconnect	Yes	"H": Normal PWM Control, "L": PWM/VFM Auto Switching Control	Normal PWM	Yes
		2A			"H": Forced PWM Control Note: "H" recommended	Forced PWM	
		1B			"H": Normal PWM Control, "L": PWM/VFM Auto Switching Control	Normal PWM	No
		2B			"H": Forced PWM Control Note: "H" recommended	Forced PWM	
		1C	Input-to-Output Bypass		"H": Normal PWM Control, "L": PWM/VFM Auto Switching Control	Normal PWM	Yes
		1D			"H": Normal PWM Control, "L": PWM/VFM Auto Switching Control	Normal PWM	No
	Adjustable Output Voltage Type	1A	Complete Output Disconnect		"H": Normal PWM Control, "L": PWM/VFM Auto Switching Control	Normal PWM	Yes
		2A			"H": Forced PWM Control Note: "H" recommended	Forced PWM	
		1B			"H": Normal PWM Control, "L": PWM/VFM Auto Switching Control	Normal PWM	No
		2B			"H": Forced PWM Control Note: "H" recommended	Forced PWM	
		1C	Input-to-Output Bypass		"H": Normal PWM Control, "L": PWM/VFM Auto Switching Control	Normal PWM	Yes
		1D			"H": Normal PWM Control, "L": PWM/VFM Auto Switching Control	Normal PWM	No
SOT-23-5	Fixed Output Voltage Type	1E	Complete Output Disconnect	No	PWM/VFM Auto Switching Control	Normal PWM	Yes
		1F			PWM/VFM Auto Switching Control	Normal PWM	No
		1G	Input-to-Output Bypass		PWM/VFM Auto Switching Control	Normal PWM	Yes
		1H			PWM/VFM Auto Switching Control	Normal PWM	No

PIN DESCRIPTION

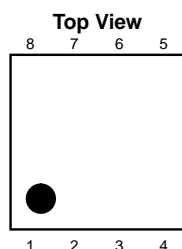

DFN(PLP)2020-8 Pin Configurations

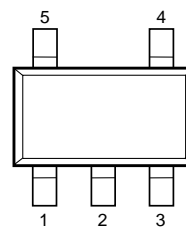
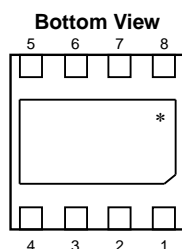

SOT-23-5 Pin Configurations

RP402Kxxxx Pin Description

Pin No.	Symbol	Description
1	MODE	Mode Pin ^{*1}
2	NC	No Connection
3	GND	Ground Pin
4	LX	Internal NMOS Switch Drain Pin
5	V _{OUT}	Output Pin
6	V _{IN}	Power Supply Pin
7	NC	No Connection
8	CE	Chip Enable Pin (Active-high)

* The tab on the bottom of the package enhances thermal performance and is electrically connected to GND (substrate level). It is recommended that the tab be connected to the ground plane on the board, or otherwise be left floating.

^{*1} MODE Pin = "H" is recommended for RP402Kxx2x.

RP402K00xx Pin Description

Pin No.	Symbol	Description
1	MODE	MODE Pin ^{*2}
2	NC	No Connection
3	GND	Ground Pin
4	LX	Internal NMOS Switch Drain Pin
5	V _{OUT}	Output Pin
6	V _{IN}	Power Supply Pin
7	V _{FB}	Feedback Input Pin for Setting Output Voltage
8	CE	Chip Enable Pin (Active-high)

* The tab on the bottom of the package enhances thermal performance and is electrically connected to GND (substrate level). It is recommended that the tab be connected to the ground plane on the board, or otherwise be left floating.

^{*2} MODE Pin = "H" is recommended for RP402Kxx2x.

RP402x

NO.EA-317-160509

RP402Nxx1x Pin Description

Pin No.	Symbol	Description
1	Lx	Internal NMOS Switch Drain Pin
2	GND	Ground Pin
3	CE	Chip Enable Pin (Active-high)
4	V _{IN}	Power Supply Pin
5	V _{OUT}	Output Pin

ABSOLUTE MAXIMUM RATINGS

Absolute Maximum Ratings

Symbol	Item	Rating	Unit	
V _{IN}	V _{IN} Pin Voltage	-0.3 to 6.5	V	
V _{OUT}	V _{OUT} Pin Voltage	-0.3 to 7.0	V	
V _{LX}	Lx Pin Voltage	-0.3 to 6.5	V	
V _{CE}	CE Pin Voltage	-0.3 to 6.5	V	
V _{FB}	V _{FB} Pin Voltage (RP402K00xx only)	-0.3 to 6.5	V	
V _{MODE}	MODE Pin Voltage (RP402Kxxxx only)	-0.3 to 6.5	V	
P _D	Power Dissipation (DFN(PLP)2020-8) ^{*1}	Standard Land Pattern	880	mW
	Power Dissipation (SOT23-5) ^{*1}	Standard Land Pattern	420	
T _a	Operating Temperature Range	-40 to 85	°C	
T _{stg}	Storage Temperature Range	-55 to 125	°C	

^{*1} Refer to *PACKAGE INFORMATION* for detailed information.

ABSOLUTE MAXIMUM RATINGS

Electronic and mechanical stress momentarily exceeded absolute maximum ratings may cause the permanent damages and may degrade the life time and safety for both device and system using the device in the field. The functional operation at or over these absolute maximum ratings is not assured.

RECOMMENDED OPERATING CONDITIONS (ELECTRICAL CHARACTERISTICS)

All of electronic equipment should be designed that the mounted semiconductor devices operate within the recommended operating conditions. The semiconductor devices cannot operate normally over the recommended operating conditions, even if when they are used over such conditions by momentary electronic noise or surge. And the semiconductor devices may receive serious damage when they continue to operate over the recommended operating conditions.

ELECTRICAL CHARACTERISTICS

The specifications surrounded by are guaranteed by design engineering at $-40^{\circ}\text{C} \leq T_a \leq 85^{\circ}\text{C}$.

RP402xxxxx Electrical Characteristics (Not applicable to RP402K00xx)

($T_a = 25^{\circ}\text{C}$)

Symbol	Item	Conditions	Min.	Typ.	Max.	Unit	
V_{IN}	Input Voltage				4.8	V	
V_{START}	Start-up Voltage	$R_L = 5.5\text{ k}\Omega$		0.7	0.8	V	
V_{HOLD}	Hold-on Voltage after start-up ^{*1}	$R_L = 5.5\text{ k}\Omega$	0.6			V	
V_{OVLO}	OVLO Voltage		4.8	5.1		V	
V_{OVP}	OVP Voltage			6.0		V	
I_{DD1}	Quiescent Current 1	$V_{IN} = V_{SET} - 0.4\text{ V}$, $V_{OUT} = 0.95 \times V_{SET}$		1.6		mA	
I_{DD2}	Quiescent Current 2 ^{*2}	$V_{IN} = V_{SET} - 0.4\text{ V}$, $V_{OUT} = V_{SET} + 0.2\text{ V}$		21	37	μA	
$I_{standby}$	Standby Current	RP402xxxxA/ B/ E/ F	$V_{IN} = 4.8\text{ V}$, $V_{OUT} = 0\text{ V}$, $V_{CE} = 0\text{ V}$		0.2	1.0	μA
		RP402xxxxC/ D/ G/ H	$V_{IN} = 4.8\text{ V}$, $V_{CE} = 0\text{ V}$		1.2	2.5	
V_{OUT}	Output Voltage	$V_{IN} = V_{CE} = 1.5\text{ V}$	x 0.985		x 1.015	V	
$\Delta V_{OUT} / \Delta T_a$	Output-Voltage Temperature Coefficient	$-40^{\circ}\text{C} \leq T_a \leq 85^{\circ}\text{C}$		± 50		ppm/ $^{\circ}\text{C}$	
f_{osc}	Switching Frequency	RP402xxx1x	$V_{IN} = 1.5\text{ V}$, $V_{OUT} = 0.95 \times V_{SET}$	1080	1200	1320	kHz
		RP402xxx2x		900 850		1000	
R_{ONN}	NMOS ON Resistance ^{*1}	$V_{OUT} = 5.0\text{ V}$		0.20		Ω	
R_{ONP}	PMOS ON Resistance ^{*1}	$V_{OUT} = 5.0\text{ V}$		0.20		Ω	
I_{CEH}	CE "H" Input Current	$V_{IN} = 4.8\text{ V}$, $V_{OUT} = V_{CE} = 5\text{ V}$			0.5	μA	
I_{CEL}	CE "L" Input Current	$V_{IN} = 4.8\text{ V}$, $V_{OUT} = 5\text{ V}$, $V_{CE} = 0\text{ V}$	-0.5			μA	
I_{MODEH}	MODE "H" Input Current ^{*3}	RP402xxx1x	$V_{IN} = 4.8\text{ V}$, $V_{CE} = 0\text{ V}$, $V_{MODE} = 5.5\text{ V}$			0.5	μA
		RP402xxx2x				72	
I_{MODEL}	MODE "L" Input Current ^{*3}	$V_{IN} = 4.8\text{ V}$, $V_{CE} = V_{MODE} = 0\text{ V}$	-0.5			μA	
I_{LXH}	Lx "H" Leakage Current	$V_{IN} = V_{OUT} = V_{LX} = 4.8\text{ V}$, $V_{CE} = 0\text{ V}$			0.5	μA	
I_{LXL}	Lx "L" Leakage Current	$V_{OUT} = 5\text{ V}$, $V_{LX} = 0\text{ V}$, $V_{CE} = 0\text{ V}$			0.5	μA	
I_{LXPEAK}	Lx Limit Current ^{*4}		1.3	1.5		A	
V_{CEH}	CE "H" Input Voltage		0.7			V	
V_{CEL}	CE "L" Input Voltage				0.3	V	
V_{MODEH}	MODE "H" Input Voltage ^{*3}		1.0			V	
V_{MODEL}	MODE "L" Input Voltage ^{*3}				0.4	V	

RP402x

NO.EA-317-160509

ELECTRICAL CHARACTERISTICS (continued)The specifications surrounded by are guaranteed by design engineering at $-40^{\circ}\text{C} \leq T_a \leq 85^{\circ}\text{C}$.**RP402xxxx Electrical Characteristics (Not applicable to RP402K00xx)**

(Ta = 25°C)

Symbol	Item	Conditions	Min.	Typ.	Max.	Unit
Maxduty	Oscillator Maximum Duty Cycle	$V_{IN} = 1.5\text{ V}$, $V_{OUT} = 0.95 \times V_{SET}$	80	88	95	%
tstart	Soft-start Time ^{*5}	Measures the time when $V_{CE} = 0\text{ V}$ to 1.5 V , $V_{OUT} = V_{SET} \times 0.95$	0.25	0.5	0.70	ms
tprot	Protection Delay Time ^{*6}	RP402xxx1x	2.7	3.3	3.9	ms
		RP402xxx2x	3.5	4.1	4.7	
R _{ONA}	Anti-ringing Switch ON Resistance ^{*7}	$V_{IN} = 2.5\text{ V}$, $V_{OUT} = 3.3\text{ V}$		100		Ω
R _{ONB}	Bypass Switch ON Resistance ^{*8}	RP402xxxxC/ D/ G/ H $V_{IN} = 3.0\text{ V}$, $V_{OUT} = 0\text{ V}$		160		Ω
I _{INZERO}	V _{IN} Zero Current	$V_{IN} = 0\text{ V}$, $V_{OUT} = 5.5\text{ V}$		0.1	1.0	μA

All test items listed under *ELECTRICAL CHARACTERISTICS* are done under the pulse load condition ($T_j \approx T_a = 25^{\circ}\text{C}$).^{*1} Hold-on Voltage and NMOS/ PMOS ON Resistance are dependent on V_{OUT} .^{*2} Quiescent Current 2 is not applicable to RP402xxx2x.^{*3} MODE "H"/ "L" Input Current/ Voltage is only applicable to RP402Kxxxx.^{*4} L_x Limit Current fluctuates depending on Duty.^{*5} $V_{IN} \geq 1.7\text{ V}$ ^{*6} Protection Delay Time is not included in RP402xxxxB/ D/ F/ H.^{*7} Anti-ringing Switch ON Resistance is dependent on V_{OUT} . Not applicable to RP402xxx2x.^{*8} Bypass Switch ON Resistance is dependent on V_{IN} .

Electrical Characteristics by Different Output Voltage

Product Name	V _{OUT} (Ta = 25°C)		
	Min.	Typ.	Max.
RP402x18xx	1.773	1.800	1.827
RP402x19xx	1.872	1.900	1.929
RP402x20xx	1.970	2.000	2.030
RP402x21xx	2.069	2.100	2.132
RP402x22xx	2.167	2.200	2.233
RP402x23xx	2.266	2.300	2.335
RP402x24xx	2.364	2.400	2.436
RP402x25xx	2.463	2.500	2.538
RP402x26xx	2.561	2.600	2.639
RP402x27xx	2.660	2.700	2.741
RP402x28xx	2.758	2.800	2.842
RP402x29xx	2.857	2.900	2.944
RP402x30xx	2.955	3.000	3.045
RP402x31xx	3.054	3.100	3.147
RP402x32xx	3.152	3.200	3.248
RP402x33xx	3.251	3.300	3.350
RP402x34xx	3.349	3.400	3.451
RP402x35xx	3.448	3.500	3.553
RP402x36xx	3.546	3.600	3.654
RP402x37xx	3.645	3.700	3.756
RP402x38xx	3.743	3.800	3.857
RP402x39xx	3.842	3.900	3.959
RP402x40xx	3.940	4.000	4.060
RP402x41xx	4.039	4.100	4.162
RP402x42xx	4.137	4.200	4.263
RP402x43xx	4.236	4.300	4.365
RP402x44xx	4.334	4.400	4.466
RP402x45xx	4.433	4.500	4.568
RP402x46xx	4.531	4.600	4.669
RP402x47xx	4.630	4.700	4.771
RP402x48xx	4.728	4.800	4.872
RP402x49xx	4.827	4.900	4.974
RP402x50xx	4.925	5.000	5.075
RP402x51xx	5.024	5.100	5.177
RP402x52xx	5.122	5.200	5.278
RP402x53xx	5.221	5.300	5.380
RP402x54xx	5.319	5.400	5.481
RP402x55xx	5.417	5.500	5.582

RP402x

NO.EA-317-160509

ELECTRICAL CHARACTERISTICS (continued)The specifications surrounded by are guaranteed by design engineering at $-40^{\circ}\text{C} \leq T_a \leq 85^{\circ}\text{C}$.**RP402K00xx Electrical Characteristics**

(Ta = 25°C)

Symbol	Item	Conditions	Min.	Typ.	Max.	Unit	
V _{IN}	Input Voltage				4.6	V	
V _{START}	Start-up Voltage	R _L = 5.5 kΩ		0.7	0.8	V	
V _{HOLD}	Hold-on Voltage after start-up ^{*1}	R _L = 5.5 kΩ	0.6			V	
V _{OVLO}	OVLO Voltage		4.6	5.1		V	
V _{OVP}	OVP Voltage			6.0		V	
I _{DD1}	Quiescent Current 1	V _{IN} = 3 V, V _{OUT} = 5 V, V _{FB} = 0.6 V		1.6		mA	
I _{DD2}	Quiescent Current 2 ^{*2}	V _{IN} = 4.8 V, V _{OUT} = 5.5 V, V _{FB} = 2.0 V, V _{MODE} = 0 V		21	37	μA	
I _{standby}	Standby Current	RP402KxxxA/ B	V _{IN} = 4.8 V, V _{OUT} = 0V, V _{CE} = 0V		0.2	1.0	μA
		RP402KxxxC/ D	V _{IN} = 4.8 V, V _{CE} = 0 V		1.2	2.5	
V _{FB}	Feedback Voltage	V _{IN} = 3.0 V, V _{OUT} = 5 V	0.985	1.00	1.015	V	
ΔV _{FB} /ΔTa	Output Voltage Temperature Coefficient	-40°C ≤ Ta ≤ 85°C		±50		ppm/°C	
fosc	Switching Frequency	RP402K001x	V _{IN} = 3.0 V, V _{OUT} = 3.3 V, V _{FB} = 0.6 V	1080	1200	1320	kHz
		RP402K002x		900		1000	
R _{ONN}	NMOS ON Resistance ^{*1}	V _{OUT} = 5.0 V		0.20		Ω	
R _{ONP}	PMOS ON Resistance ^{*1}	V _{OUT} = 5.0 V		0.20		Ω	
I _{CEH}	CE "H" Input Current	V _{IN} = 4.8 V, V _{OUT} = V _{CE} = 5.5 V			0.5	μA	
I _{CEL}	CE "L" Input Current	V _{IN} = 4.8 V, V _{OUT} = 5 V, V _{CE} = 0 V	-0.5			μA	
I _{MODEH}	MODE "H" Input Current	RP402K001x	V _{IN} = 4.8 V, V _{MODE} = 5.5 V, V _{CE} = 0 V			0.5	μA
		RP402K002x				72	
I _{MODEL}	MODE "H" Input Current	V _{IN} = 4.8 V, V _{CE} = V _{MODE} = 0 V	-0.5			μA	
I _{LXH}	Lx "H" Leakage Current	V _{IN} = V _{OUT} = V _{LX} = 4.8 V, V _{CE} = 0 V			0.5	μA	
I _{LXL}	Lx "L" Leakage Current	V _{OUT} = 5.0 V, V _{LX} = 0 V, V _{CE} = 0 V			0.5	μA	
I _{LXPEAK}	Lx Limit Current ^{*3}		1.3	1.5		A	
V _{CEH}	CE "H" Input Voltage		0.7			V	
V _{CEL}	CE "L" Input Voltage				0.3	V	
V _{MODEH}	MODE "H" Input Voltage		1.0			V	

ELECTRICAL CHARACTERISTICS (continued)

The specifications surrounded by are guaranteed by design engineering $-40^{\circ}\text{C} \leq T_a \leq 85^{\circ}\text{C}$.

RP402K00xx Electrical Characteristics

($T_a = 25^{\circ}\text{C}$)

Symbol	Item	Conditions	Min.	Typ.	Max.	Unit
V_{MODEL}	MODE "L" Input Voltage				0.4	V
Maxduty	Oscillator Maximum Duty Cycle	$V_{\text{IN}} = 3.0\text{ V}$, $V_{\text{OUT}} = 3.3\text{ V}$, $V_{\text{FB}} = 0.6\text{ V}$	80	88	95	%
tstart	Soft-start Time ^{*4}	Measures the time when $V_{\text{OUT}} = 3.3\text{ V}$, $V_{\text{CE}} = 0\text{ V}$ to 1.5 V , $V_{\text{OUT}} = 3.13\text{ V}$	0.25	0.5	0.70	ms
tprot	Protection Delay Time ^{*5}	RP402K001x	2.7	3.3	3.9	ms
		RP402K002x	3.5	4.1	4.7	ms
R_{ONA}	Anti-ringing Switch ON Resistance ^{*6}	$V_{\text{IN}} = 2.5\text{ V}$, $V_{\text{OUT}} = 3.3\text{ V}$		100		Ω
R_{ONB}	Bypass Switch ON Resistance ^{*7}	RP402KxxxC/ D	$V_{\text{IN}} = 3.0\text{ V}$, $V_{\text{OUT}} = 0\text{ V}$	160		Ω
I_{INZERO}	V_{IN} Zero Current	$V_{\text{IN}} = 0\text{ V}$, $V_{\text{OUT}} = 5.5\text{ V}$		0.1	1.0	μA

All test items listed under *ELECTRICAL CHARACTERISTICS* are done under the pulse load condition ($T_j \approx T_a = 25^{\circ}\text{C}$).

*1 Hold-on Voltage and NMOS/ PMOS ON Resistance are dependent on V_{OUT} .

*2 Quiescent Current 2 is not applicable to RP402K002x.

*3 L_x Limit Current fluctuates depending on Duty.

*4 Soft-start Time is $V_{\text{IN}} \geq 1.7\text{ V}$.

*5 Protection Delay Time is not applicable to RP402K00xB/ 001D.

*6 Anti-ringing Switch ON Resistance is dependent on V_{OUT} . Not applicable to RP402K002x.

*7 Bypass Switch ON Resistance is dependent on V_{IN} .

TYPICAL APPLICATION

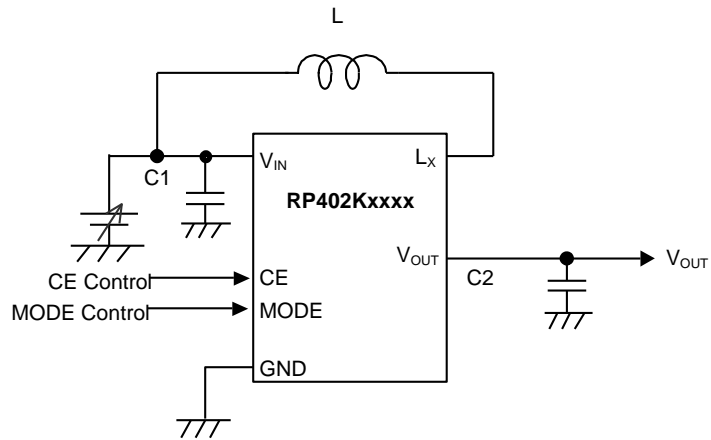

RP402Kxxxx Typical Application (Fixed Output Voltage Type)

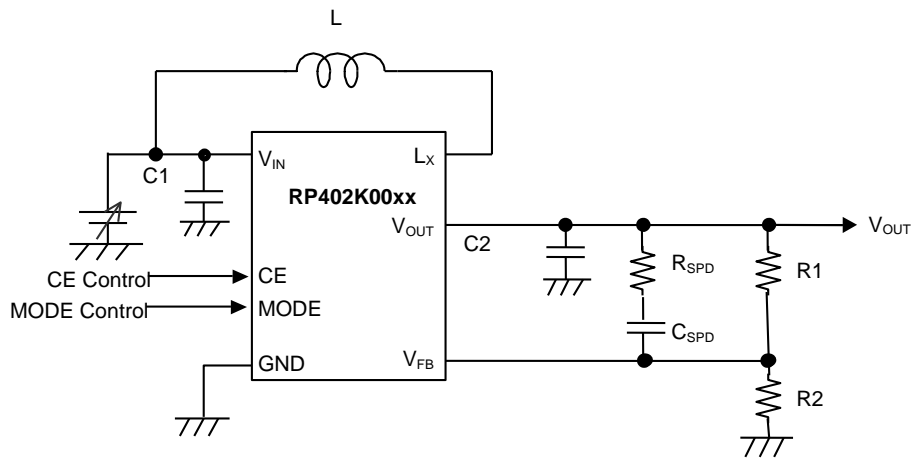

RP402K00xx Typical Application (Adjustable Output Voltage Type)

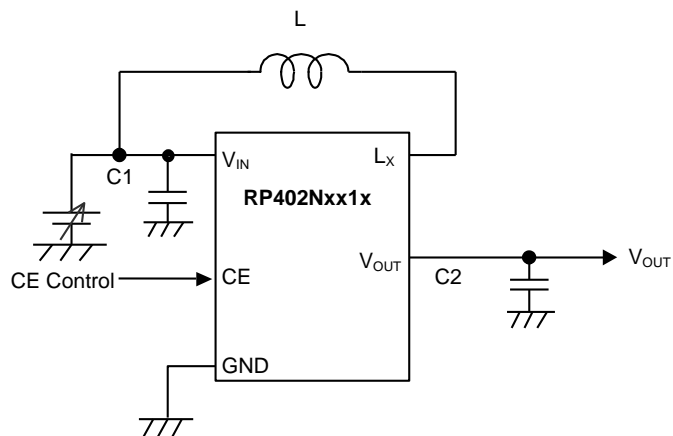

RP402Nxx1x Typical Application (Fixed Output Voltage Typ)

Recommended Components

Symbol	Descriptions
L	VLF403215MT-2R2M, 2.2 μ H, TDK
C1 (C _{IN})	GRM188R60J106ME47, 10 μ F, Murata
C2 (C _{OUT})	GRM188R60J106ME47, 10 μ F x 2, Murata As for the fixed output voltage type (RP402x50xx), 10 μ F x 1 can be used if the mounting area is limited.
C _{SPD}	<p>The speedup capacitor (C_{SPD}) is required for the adjustable output voltage type. Connect C_{SPD} in parallel with the output resistor (R1). To calculate the C_{SPD} value, the following equation can be used:</p> $f = 1 / (2 \pi \times C_{SPD} \times R1)$ <p>Adjust the C_{SPD} value to make the oscillator frequency (f) approximately 20 kHz. For example, V_{OUT} = 5.0 V, R1 = 2 MΩ, R2 = 500 kΩ and C_{SPD} = 4 pF.</p> <p>The R1 and R2 values are calculated based on the operation efficiency under a light load, therefore R1 and R2 are having high-resistance values. The feedback voltage (V_{FB}) can be affected by noise. To stabilize the device operation, decrease the R1 and R2 values.</p>
R _{SPD}	<p>The speedup resistor (R_{SPD}) is required for the adjustable output voltage type. Using R_{SPD} can prevent the deterioration of the characteristics due to noise. If there's a possibility of generation of a spike noise, use an approximately 1 kΩ R_{SPD}.</p>

TECHNICAL NOTES

The performance of power source circuits using this device largely depends on the peripheral circuits. When selecting the peripheral components, consider the conditions of use. Do not allow each component, PCB pattern and the device to exceed their respected rated values (voltage, current and power) when designing the peripheral circuits.

- Ensure the V_{IN} and GND lines are firmly connected. A large switching current flows through the GND lines and the V_{IN} line. If their impedance is too high, noise pickup or unstable operation may result. When the built-in switch is turned off, the inductor may generate a spike-shaped high voltage. Use the high-breakdown voltage capacitor (C_{OUT}) which output voltage is 1.5 times or more than the set output voltage.
- After a boosting of the step-up converter, the converter uses V_{OUT} as a main power source. Therefore, the ceramic capacitor between the V_{OUT} pin and the GND pin acts as a bypass capacitor. Considering the bias dependence, place a 10 μ F or more ceramic capacitor (C_{OUT}) between the V_{OUT} pin - the GND pin as close as possible. Also, place an approximately 10 μ F ceramic capacitor (C_{IN}) between the V_{IN} pin - the GND pin.
- Use a 2.2 μ H inductor (L) which is having a low equivalent series resistance, having enough tolerable current and which is less likely to cause magnetic saturation.
- The MODE pin is controlled with a logic voltage. To make it "H", 1.0 V or more must be forced to the MODE pin. If power supply is less than 1.0 V, MODE pin must be pulled up to V_{OUT} .
- When using Forced PWM Control Type, the MODE pin should be "H".
- The RP402x can reset the latch protection circuit with the CE signal. However, starting up the device while C_{IN} is too large and V_{IN} is less than 0.8 V cannot reset the latch protection circuit correctly. Likewise, starting up the device while the CE pin is shorted to the V_{IN} pin or V_{OUT} pin cannot reset the latch protection circuit correctly.

THEORY OF OPERATION

Forced PWM Control Type (RP402xx2A/ B)

While normal PWM control type prevents the reverse inductor current at light load, forced PWM control type makes the inductor current reverse in order to eliminate the discontinuous current period. Therefore, even at light load or when the voltage difference between input and output is less, forced PWM control type can provide PWM operation without bursting.

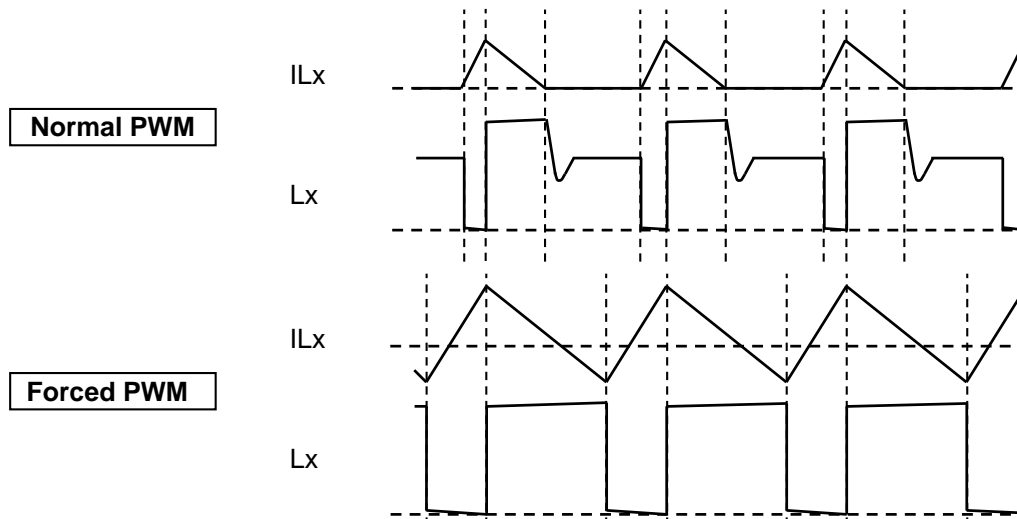

Operating Waveform of Normal PWM/ Forced PWM Control Type

There is a case that forced PWM control performs burst operation without PWM operation because of the conditions of use. The conditions which cause burst operation are various and differ in set output voltage, input voltage, ambient temperature and load current.

Please note that forced PWM control type decreases the efficiency at light load and does not include anti-ringing switch. The graph below indicates the typical operational maximum input voltage of forced PWM control type.

RP402Kxx1x: MODE = "H" (Normal PWM), RP402Kxx2x: (Forced PWM)

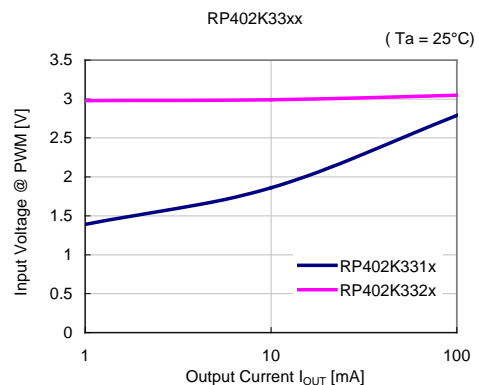
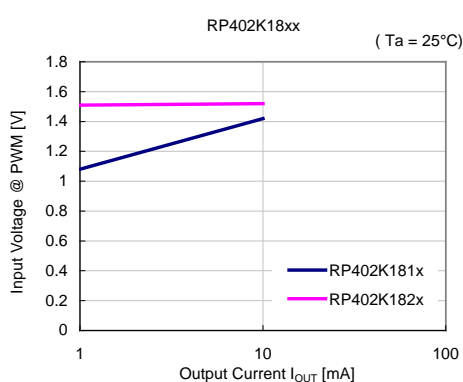

RP402x

NO.EA-317-160509

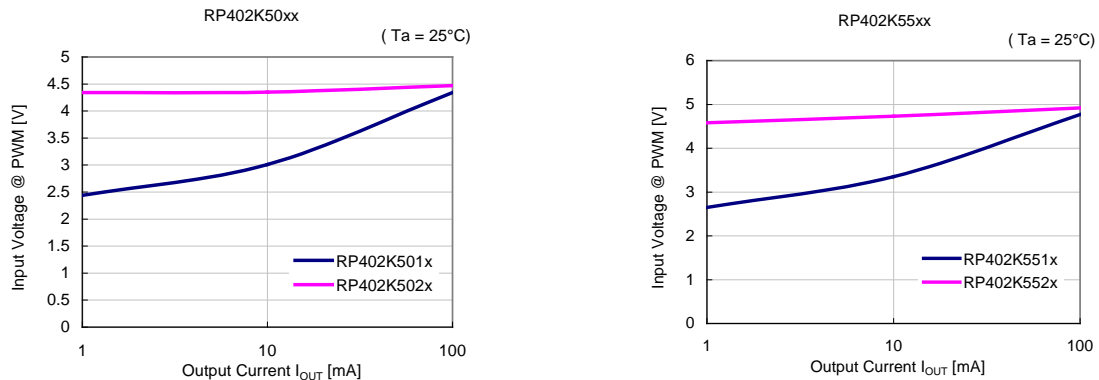

[MODE Pin]

It is recommended that the MODE pin ("H") be connected to the V_{OUT} pin or the V_{IN} pin to ensure stability; however, connecting the MODE pin to the V_{OUT} pin can ensure better stability. Please note that the MODE pin is pulled down by a resistor inside the device, so a current flows through the pull-down resistor to consume power. Connecting the MODE pin to GND or using it in the open state is another option.

Bypass Mode Application Example (RP402xxxxC/ D/ G/ H)

The RP402xxxxC/ D/ G/ H is available in bypass mode when $CE = L$. The shown below is the application example of the device in bypass mode. In this application, when the main system is not in sleep, the RP402xxxxC/ D/ G/ H is set to active state to supply power to the main system and RTC. When the main system is in sleep, the RP402xxxxC/ D/ G/ H is set to standby state to supply power to RTC in bypass mode. Using the device in the bypass mode can reduce the power loss and the consumption of battery. Also, using the device in bypass mode can eliminate external components for short-circuit protection.

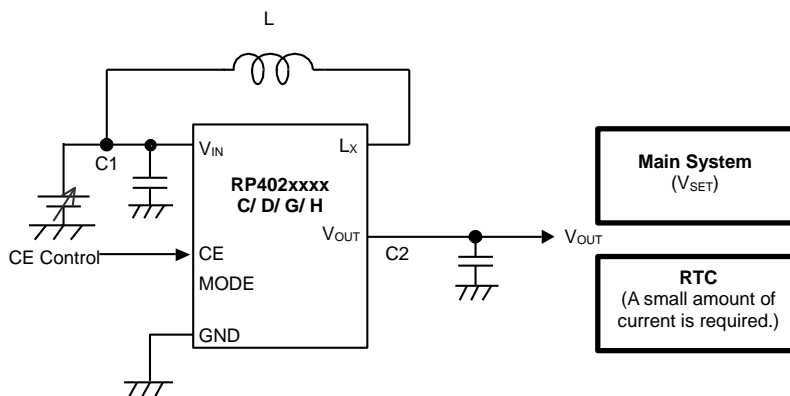

Regulation Operation at $V_{IN} > V_{OUT}$

The RP402x regulates the output voltage to the set output voltage even when the input voltage is higher than the set output voltage. Please note that this regulation operation decreases the efficiency and the maximum output current driving ability. The maximum output current driving ability can be different due to the set output voltage, the input voltage and the ambient temperature.

The following is the switching condition (Typ.) from step-up operation to the step-down regulation.

$V_{IN} \leq V_{OUT} - 150 \text{ mV}$: Step-down regulation → Step-up operation

$V_{IN} > V_{OUT} - 100 \text{ mV}$: Step-up operation → Step-down regulation

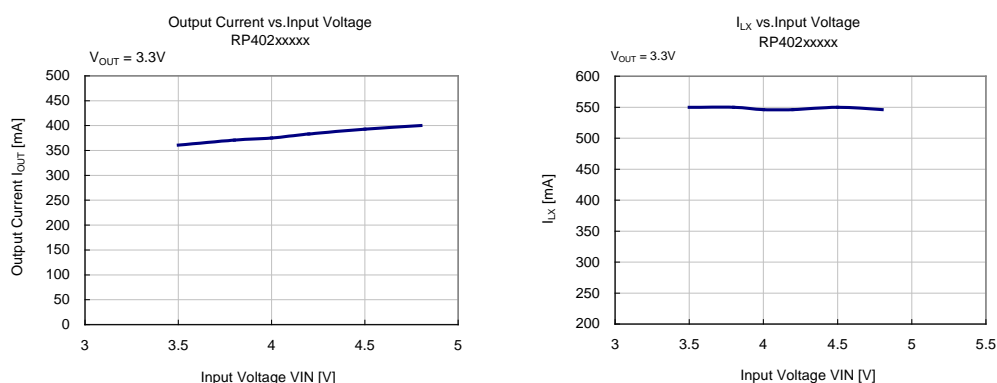

Output Voltage Setting for RP402K00xx

The RP402K00xx can set the output voltage freely by the external divider resistors using the following equation.

$$\text{Output Voltage} = V_{FB} \times (R1 + R2) / R2 \quad (V_{FB} = 1.0 \text{ V})$$

Zero Input Complete Shutdown at $V_{IN} = 0 \text{ V}$

The RP402x provides a zero input complete shutdown function that allows the device to shut down the output when $V_{IN} = 0 \text{ V}$ or V_{IN} is open. This function protects against reverse current flow from V_{OUT} to V_{IN} when a voltage is applied to the V_{OUT} pin while $V_{IN} = 0 \text{ V}$ or V_{IN} is open.

Overcurrent Protection

The RP402x incorporates a I_{LX} peak current limit circuit as the overcurrent protection circuit which controls the duty of I_{LX} when the I_{LX} peak current (I_{LXPEAK}) reaches typically 1.5 A.

Latch Type Protection (RP402xxxxA/ C/ E/ G)

The RP402xxxxA/ C/ E/ G provides a latch type protection circuit to latch the power MOSFET to the off state in order to stop the DC/DC operation. To release the latch type protection, switch the CE pin from high to low once and switch it back to high. Please note that the I_{LX} peak current (I_{LXPEAK}) and the protection delay time (t_{prot}) are easily affected by the self-heating or heat radiation efficiency. The large reduction in input voltage (V_{IN}) or the unstable input voltage caused by short-circuit may affect the protection operation or protection delay time.

RP402x

NO.EA-317-160509

Short-circuit Protection

The RP402x provides a short-circuit protection circuit which stops the switching operation when a short-circuit is detected. If a short-circuit state is released after a preset time, the device performs stable restart with soft-start operation.

Overvoltage Protection

The RP402x provides an overvoltage lockout (OVLO) circuit for monitoring the input pin voltage and an overvoltage protection (OVP) circuit for monitoring the output pin voltage. These circuits stops the switching operation when an overvoltage is detected. If the output voltage is dropped below the set output voltage when OVLO is released, the output voltage will be boosted to the set output voltage.

OUTPUT CURRENT AND SELECTION OF EXTERNAL COMPONENTS

Operation of Step-up DC/DC Converter and Output Current

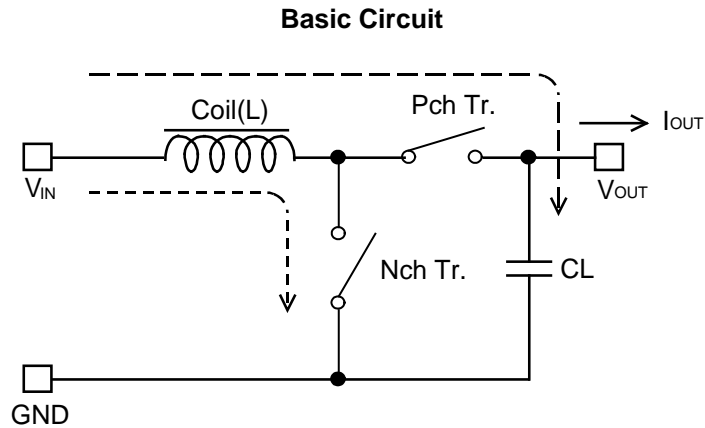

The inductor current (IL) flowing through the inductor (L)

Discontinuous Mode

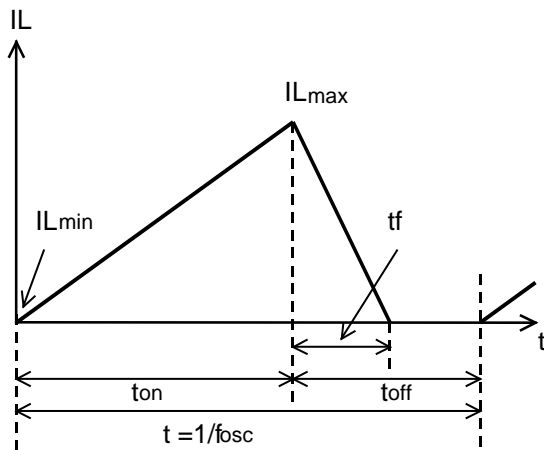

Continuous Mode

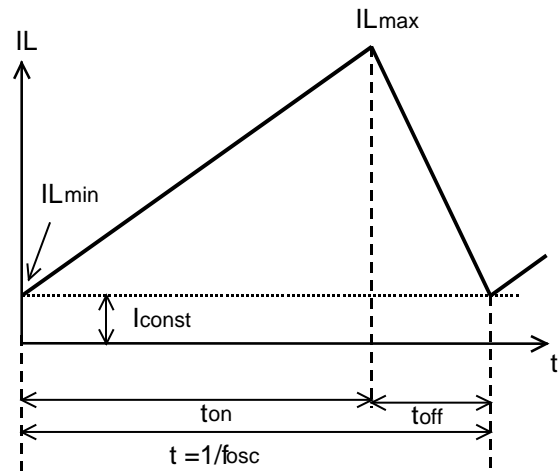

A PWM control type step-up DC/DC converter has two operation modes characterized by the continuity of inductor current: discontinuous current mode and continuous current mode.

The voltage applied to the inductor L, when transistor is ON, is described as “V_{IN}”. So, the current is described as “V_{IN} x t / L”.

Therefore, the electric power (P_{ON}) supplied from the input side, while transistor is ON, is described as follows:

$$P_{ON} = \int_0^{ton} V_{IN}^2 \times t/L dt \dots\dots\dots \text{Equation 1}$$

In step-up circuit, power source supplies the electric power (P_{OFF}) even while transistor is OFF. The input current supplied by power source while transistor is OFF is described as “ $(V_{OUT} - V_{IN}) \times t / L$ ”. Therefore, the electric power P_{OFF} is described as follows:

$$P_{OFF} = \int_0^{t_f} V_{IN} \times (V_{OUT} - V_{IN}) \times t/L \, dt \dots\dots\dots \text{Equation 2}$$

The time of which the inductance L releases the saved energy is described as “ t_f ”. Therefore, the average electric power (P_{AV}) in a cycle is described as follows:

$$P_{AV} = 1/(t_{on} + t_{off}) \times \left\{ \int_0^{t_{on}} V_{IN}^2 \times t/L \, dt + \int_0^{t_f} V_{IN} \times (V_{OUT} - V_{IN}) \times t/L \, dt \right\} \dots\dots\dots \text{Equation 3}$$

In PWM control, when “ $t_f = t_{off}$ ”, the inductor current becomes continuous, so the switching regulator operation turns into continuous current mode. The current deviation between On time and Off time is equal under steady-state condition of continuous current mode as follows:

$$V_{IN} \times t_{on} / L = (V_{OUT} - V_{IN}) \times t_{off} / L \dots\dots\dots \text{Equation 4}$$

The electric power (P_{AV}) is equal to the output voltage ($V_{OUT} \times I_{OUT}$). Therefore, I_{OUT} is as follows:

$$I_{OUT} = f_{OSC} \times V_{IN}^2 \times t_{on}^2 / \{2 \times L \times (V_{OUT} - V_{IN})\} = V_{IN}^2 \times t_{on} / (2 \times L \times V_{OUT}) \dots\dots\dots \text{Equation 5}$$

When I_{OUT} becomes more than $V_{IN} \times t_{on} \times t_{off} / (2 \times L \times (t_{on} + t_{off}))$, the inductor current becomes continuous, so the switching regulator operation turns into continuous current mode. The continuous inductor current is described as I_{CONST} , so I_{OUT} is described as follows:

$$I_{OUT} = f_{OSC} \times V_{IN}^2 \times t_{on}^2 / (2 \times L \times (V_{OUT} - V_{IN})) + V_{IN} \times I_{CONST} / V_{OUT} \dots\dots\dots \text{Equation 6}$$

The peak current (I_{Lmax}) flowing through the inductor is described as follows:

$$I_{Lmax} = I_{CONST} + V_{IN} \times t_{on} / L \dots\dots\dots \text{Equation 7}$$

Put Equation 4 into Equation 6 to solve I_{Lmax} . I_{Lmax} is described as follows:

$$I_{Lmax} = V_{OUT} / V_{IN} \times I_{OUT} + V_{IN} \times t_{on} / (2 \times L) \dots\dots\dots \text{Equation 8}$$

However, $t_{on} = (1 - V_{IN} / V_{OUT}) / f_{OSC}$. The peak current is more than I_{OUT} .

Please consider I_{Lmax} when setting conditions of input and output, as well as selecting the external components. The peak current in the discontinuous current mode in Equation 7 can be calculated by $I_{CONST} = 0$.

Please note: The above calculation formulas are based on the ideal operation of the device in continuous mode. The loss caused by the external components and the built-in Lx switch are not included. Please use the peak current in Equation 8 as a reference when selecting an inductor.

TIMING CHART

Soft-start Operation and Latch-type Protection Operation

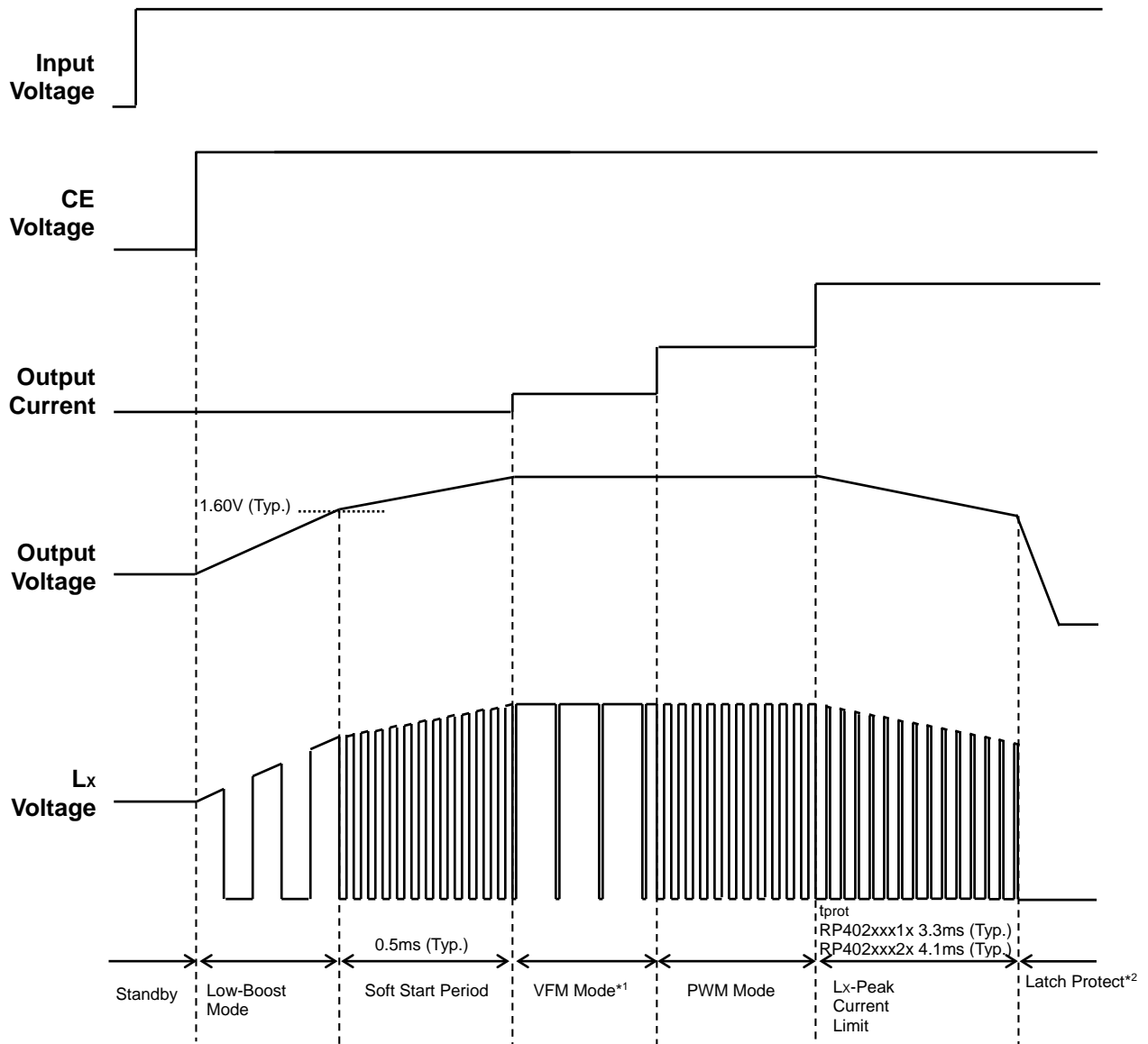

*1 Only for RP402xxx1x (MODE = "L")

*2 Only for RP402xxxxA/ C/ E/ G

< Start-up >

When CE is changed from "L" to "H", DC/DC converter starts up the operation. The RP402x has Low-Boost mode which can start up with low voltage such as 0.7 V. The DC/DC boosts up with Low-Boost mode until the output voltage reaches to typically 1.6 V. When the output voltage becomes more than or equal to typically 1.6 V, the soft-start operation starts in order to control inrush current. The DC/DC boosts up the output voltage until it reaches to the setting output voltage.

RP402x

NO.EA-317-160509

Please note: During Low-Boost mode, the oscillator frequency is dropped, so the step-up ability is low compared to the normal operation mode. Please pay attention to the step-up ratio and the load current. Soft-start time depends on “set output voltage”, “input voltage”, “ambient temperature”, and “load current”.

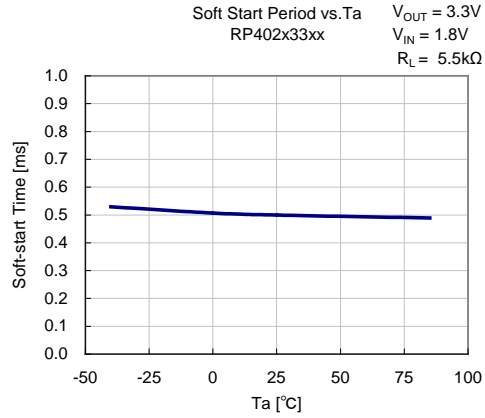
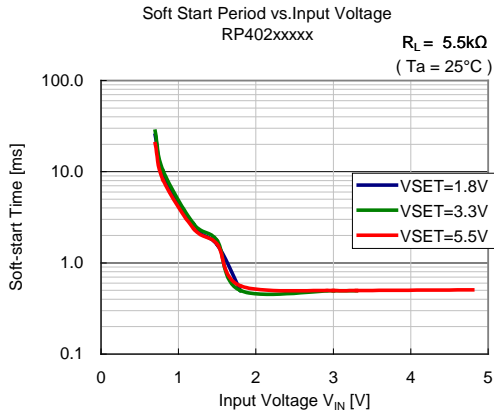

PACKAGE INFORMATION

POWER DISSIPATION (DFN(PLP)2020-8)

Power Dissipation (P_D) of the package is dependent on PCB material, layout, and environmental conditions. The following conditions are used in this measurement.

Measurement Conditions

	Standard Land Pattern
Environment	Mounting on Board (Wind Velocity = 0 m/s)
Board Material	Glass Cloth Epoxy Plastic (Double-sided)
Board Dimensions	40 mm x 40 mm x 1.6 mm
Copper Ratio	Top side: Approx. 50%, Back side: Approx. 50%
Through-holes	ϕ 0.54 mm x 30 pcs

Measurement Result

($T_a = 25^\circ\text{C}$, $T_{j\text{max}} = 125^\circ\text{C}$)

	Standard Land Pattern
Power Dissipation	880 mW
Thermal Resistance	$\theta_{ja} = (125 - 25^\circ\text{C}) / 0.88 \text{ W} = 114^\circ\text{C/W}$

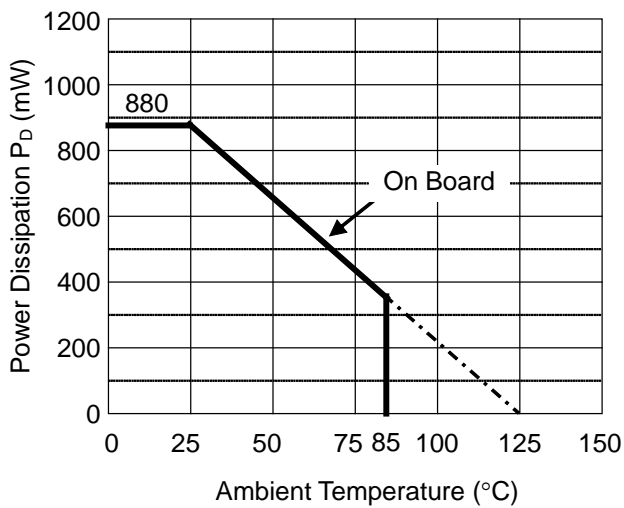

Power Dissipation vs. Ambient Temperature

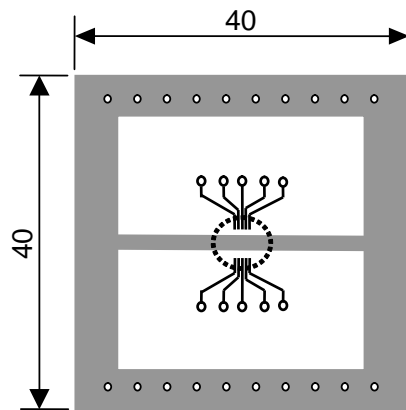

○ IC Mount Area (Unit: mm)

Measurement Board Pattern

PACKAGE DIMENSIONS (DFN(PLP)2020-8)

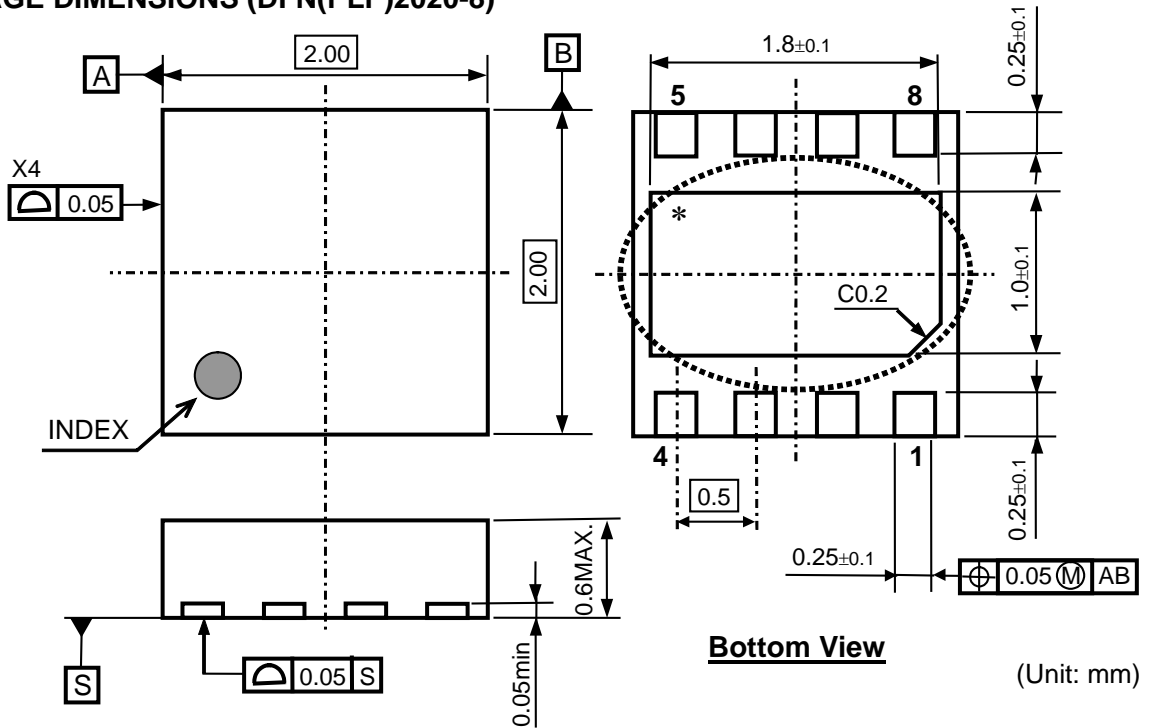

* The tab on the bottom of the package enhances thermal performance and is electrically connected to GND (substrate level). It is recommended that the tab be connected to the ground plane on the board, or otherwise be left floating.

DFN(PLP)2020-8 Package Dimensions

MARK SPECIFICATION (DFN(PLP)2020-8)

- ①②③④: Product Code ... **Refer to MARK SPECIFICATION TABLE DFN(PLP)2020-8**
- ⑤⑥: Lot Number ... Alphanumeric Serial Number

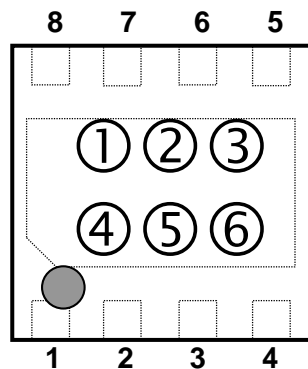

DFN(PLP)2020-8 Mark Specification

MARK SPECIFICATION TABLE (DFN(PLP)2020-8)

RP402Kxxxx Mark Specification Table

Product Name	①②③④	Product Name	①②③④	Product Name	①②③④	V _{SET}
RP402K181A	E B 1 8	RP402K182A	E C 1 8	RP402K181B	E D 1 8	1.8 V
RP402K191A	E B 1 9	RP402K192A	E C 1 9	RP402K191B	E D 1 9	1.9 V
RP402K201A	E B 2 0	RP402K202A	E C 2 0	RP402K201B	E D 2 0	2.0 V
RP402K211A	E B 2 1	RP402K212A	E C 2 1	RP402K211B	E D 2 1	2.1 V
RP402K221A	E B 2 2	RP402K222A	E C 2 2	RP402K221B	E D 2 2	2.2 V
RP402K231A	E B 2 3	RP402K232A	E C 2 3	RP402K231B	E D 2 3	2.3 V
RP402K241A	E B 2 4	RP402K242A	E C 2 4	RP402K241B	E D 2 4	2.4 V
RP402K251A	E B 2 5	RP402K252A	E C 2 5	RP402K251B	E D 2 5	2.5 V
RP402K261A	E B 2 6	RP402K262A	E C 2 6	RP402K261B	E D 2 6	2.6 V
RP402K271A	E B 2 7	RP402K272A	E C 2 7	RP402K271B	E D 2 7	2.7 V
RP402K281A	E B 2 8	RP402K282A	E C 2 8	RP402K281B	E D 2 8	2.8 V
RP402K291A	E B 2 9	RP402K292A	E C 2 9	RP402K291B	E D 2 9	2.9 V
RP402K301A	E B 3 0	RP402K302A	E C 3 0	RP402K301B	E D 3 0	3.0 V
RP402K311A	E B 3 1	RP402K312A	E C 3 1	RP402K311B	E D 3 1	3.1 V
RP402K321A	E B 3 2	RP402K322A	E C 3 2	RP402K321B	E D 3 2	3.2 V
RP402K331A	E B 3 3	RP402K332A	E C 3 3	RP402K331B	E D 3 3	3.3 V
RP402K341A	E B 3 4	RP402K342A	E C 3 4	RP402K341B	E D 3 4	3.4 V
RP402K351A	E B 3 5	RP402K352A	E C 3 5	RP402K351B	E D 3 5	3.5 V
RP402K361A	E B 3 6	RP402K362A	E C 3 6	RP402K361B	E D 3 6	3.6 V
RP402K371A	E B 3 7	RP402K372A	E C 3 7	RP402K371B	E D 3 7	3.7 V
RP402K381A	E B 3 8	RP402K382A	E C 3 8	RP402K381B	E D 3 8	3.8 V
RP402K391A	E B 3 9	RP402K392A	E C 3 9	RP402K391B	E D 3 9	3.9 V
RP402K401A	E B 4 0	RP402K402A	E C 4 0	RP402K401B	E D 4 0	4.0 V
RP402K411A	E B 4 1	RP402K412A	E C 4 1	RP402K411B	E D 4 1	4.1 V
RP402K421A	E B 4 2	RP402K422A	E C 4 2	RP402K421B	E D 4 2	4.2 V
RP402K431A	E B 4 3	RP402K432A	E C 4 3	RP402K431B	E D 4 3	4.3 V
RP402K441A	E B 4 4	RP402K442A	E C 4 4	RP402K441B	E D 4 4	4.4 V
RP402K451A	E B 4 5	RP402K452A	E C 4 5	RP402K451B	E D 4 5	4.5 V
RP402K461A	E B 4 6	RP402K462A	E C 4 6	RP402K461B	E D 4 6	4.6 V
RP402K471A	E B 4 7	RP402K472A	E C 4 7	RP402K471B	E D 4 7	4.7 V
RP402K481A	E B 4 8	RP402K482A	E C 4 8	RP402K481B	E D 4 8	4.8 V
RP402K491A	E B 4 9	RP402K492A	E C 4 9	RP402K491B	E D 4 9	4.9 V
RP402K501A	E B 5 0	RP402K502A	E C 5 0	RP402K501B	E D 5 0	5.0 V
RP402K511A	E B 5 1	RP402K512A	E C 5 1	RP402K511B	E D 5 1	5.1 V
RP402K521A	E B 5 2	RP402K522A	E C 5 2	RP402K521B	E D 5 2	5.2 V
RP402K531A	E B 5 3	RP402K532A	E C 5 3	RP402K531B	E D 5 3	5.3 V
RP402K541A	E B 5 4	RP402K542A	E C 5 4	RP402K541B	E D 5 4	5.4 V
RP402K551A	E B 5 5	RP402K552A	E C 5 5	RP402K551B	E D 5 5	5.5 V

RP402x

NO.EA-317-160509

MARK SPECIFICATION TABLE (DFN(PLP)2020-8) (continued)**RP402Kxxxx Mark Specification Table**

Product Name	①②③④	Product Name	①②③④	Product Name	①②③④	V _{SET}
RP402K182B	E E 1 8	RP402K181C	E F 1 8	RP402K181D	E G 1 8	1.8 V
RP402K192B	E E 1 9	RP402K191C	E F 1 9	RP402K191D	E G 1 9	1.9 V
RP402K202B	E E 2 0	RP402K201C	E F 2 0	RP402K201D	E G 2 0	2.0 V
RP402K212B	E E 2 1	RP402K211C	E F 2 1	RP402K211D	E G 2 1	2.1 V
RP402K222B	E E 2 2	RP402K221C	E F 2 2	RP402K221D	E G 2 2	2.2 V
RP402K232B	E E 2 3	RP402K231C	E F 2 3	RP402K231D	E G 2 3	2.3 V
RP402K242B	E E 2 4	RP402K241C	E F 2 4	RP402K241D	E G 2 4	2.4 V
RP402K252B	E E 2 5	RP402K251C	E F 2 5	RP402K251D	E G 2 5	2.5 V
RP402K262B	E E 2 6	RP402K261C	E F 2 6	RP402K261D	E G 2 6	2.6 V
RP402K272B	E E 2 7	RP402K271C	E F 2 7	RP402K271D	E G 2 7	2.7 V
RP402K282B	E E 2 8	RP402K281C	E F 2 8	RP402K281D	E G 2 8	2.8 V
RP402K292B	E E 2 9	RP402K291C	E F 2 9	RP402K291D	E G 2 9	2.9 V
RP402K302B	E E 3 0	RP402K301C	E F 3 0	RP402K301D	E G 3 0	3.0 V
RP402K312B	E E 3 1	RP402K311C	E F 3 1	RP402K311D	E G 3 1	3.1 V
RP402K322B	E E 3 2	RP402K321C	E F 3 2	RP402K321D	E G 3 2	3.2 V
RP402K332B	E E 3 3	RP402K331C	E F 3 3	RP402K331D	E G 3 3	3.3 V
RP402K342B	E E 3 4	RP402K341C	E F 3 4	RP402K341D	E G 3 4	3.4 V
RP402K352B	E E 3 5	RP402K351C	E F 3 5	RP402K351D	E G 3 5	3.5 V
RP402K362B	E E 3 6	RP402K361C	E F 3 6	RP402K361D	E G 3 6	3.6 V
RP402K372B	E E 3 7	RP402K371C	E F 3 7	RP402K371D	E G 3 7	3.7 V
RP402K382B	E E 3 8	RP402K381C	E F 3 8	RP402K381D	E G 3 8	3.8 V
RP402K392B	E E 3 9	RP402K391C	E F 3 9	RP402K391D	E G 3 9	3.9 V
RP402K402B	E E 4 0	RP402K401C	E F 4 0	RP402K401D	E G 4 0	4.0 V
RP402K412B	E E 4 1	RP402K411C	E F 4 1	RP402K411D	E G 4 1	4.1 V
RP402K422B	E E 4 2	RP402K421C	E F 4 2	RP402K421D	E G 4 2	4.2 V
RP402K432B	E E 4 3	RP402K431C	E F 4 3	RP402K431D	E G 4 3	4.3 V
RP402K442B	E E 4 4	RP402K441C	E F 4 4	RP402K441D	E G 4 4	4.4 V
RP402K452B	E E 4 5	RP402K451C	E F 4 5	RP402K451D	E G 4 5	4.5 V
RP402K462B	E E 4 6	RP402K461C	E F 4 6	RP402K461D	E G 4 6	4.6 V
RP402K472B	E E 4 7	RP402K471C	E F 4 7	RP402K471D	E G 4 7	4.7 V
RP402K482B	E E 4 8	RP402K481C	E F 4 8	RP402K481D	E G 4 8	4.8 V
RP402K492B	E E 4 9	RP402K491C	E F 4 9	RP402K491D	E G 4 9	4.9 V
RP402K502B	E E 5 0	RP402K501C	E F 5 0	RP402K501D	E G 5 0	5.0 V
RP402K512B	E E 5 1	RP402K511C	E F 5 1	RP402K511D	E G 5 1	5.1 V
RP402K522B	E E 5 2	RP402K521C	E F 5 2	RP402K521D	E G 5 2	5.2 V
RP402K532B	E E 5 3	RP402K531C	E F 5 3	RP402K531D	E G 5 3	5.3 V
RP402K542B	E E 5 4	RP402K541C	E F 5 4	RP402K541D	E G 5 4	5.4 V
RP402K552B	E E 5 5	RP402K551C	E F 5 5	RP402K551D	E G 5 5	5.5 V

RP402K00xx Mark Specification Table (Adjustable Output Voltage Type)

Product Name	①②③④	V _{SET}
RP402K001A	E H 0 1	—
RP402K002A	E H 0 2	—
RP402K001B	E H 0 3	—
RP402K002B	E H 0 4	—
RP402K001C	E H 0 5	—
RP402K001D	E H 0 6	—

RP402x

NO.EA-317-160509

POWER DISSIPATION (SOT-23-5)

Power Dissipation (P_D) of the package is dependent on PCB material, layout, and environmental conditions. The following conditions are used in this measurement. This data is taken from the SOT-23-6 package.

Measurement Conditions

	Standard Land Pattern
Environment	Mounting on Board (Wind Velocity = 0 m/s)
Board Material	Glass Cloth Epoxy Plastic (Double-sided)
Board Dimensions	40 mm x 40 mm x 1.6 mm
Copper Ratio	Top side: Approx. 50%, Back side: Approx. 50%
Through-holes	ϕ : 0.5 mm x 44 pcs

Measurement Result

($T_a = 25^\circ\text{C}$, $T_{j\text{max}} = 125^\circ\text{C}$)

	Standard Land Pattern	Free Air
Power Dissipation	420 mW	250 mW
Thermal Resistance	$\theta_{ja} = (125 - 25^\circ\text{C}) / 0.42\text{W} = 238^\circ\text{C/W}$	400 $^\circ\text{C/W}$

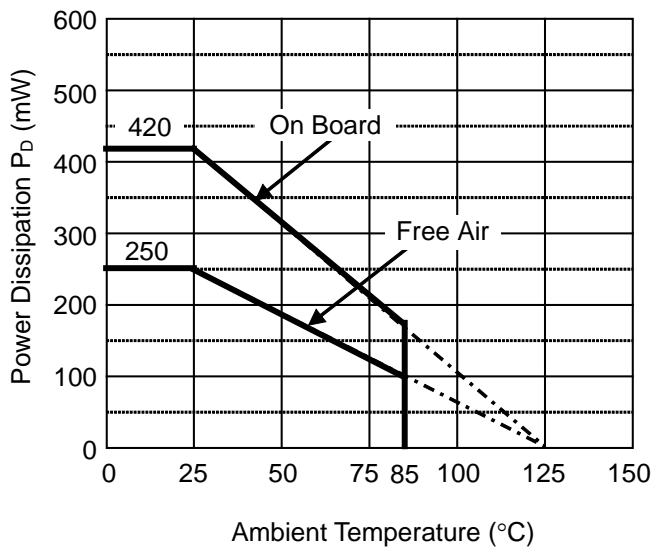

Power Dissipation vs. Ambient Temperature

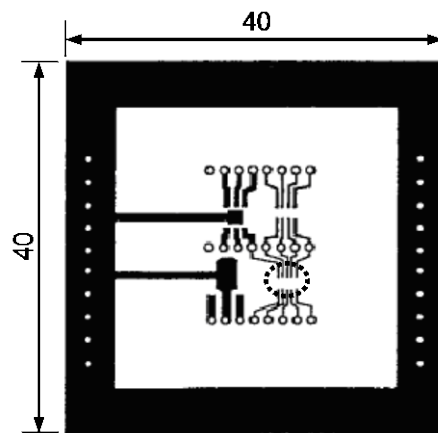

○ IC Mount Area (Unit: mm)

Measurement Board Pattern

PACKAGE DIMENSIONS (SOT-23-5)

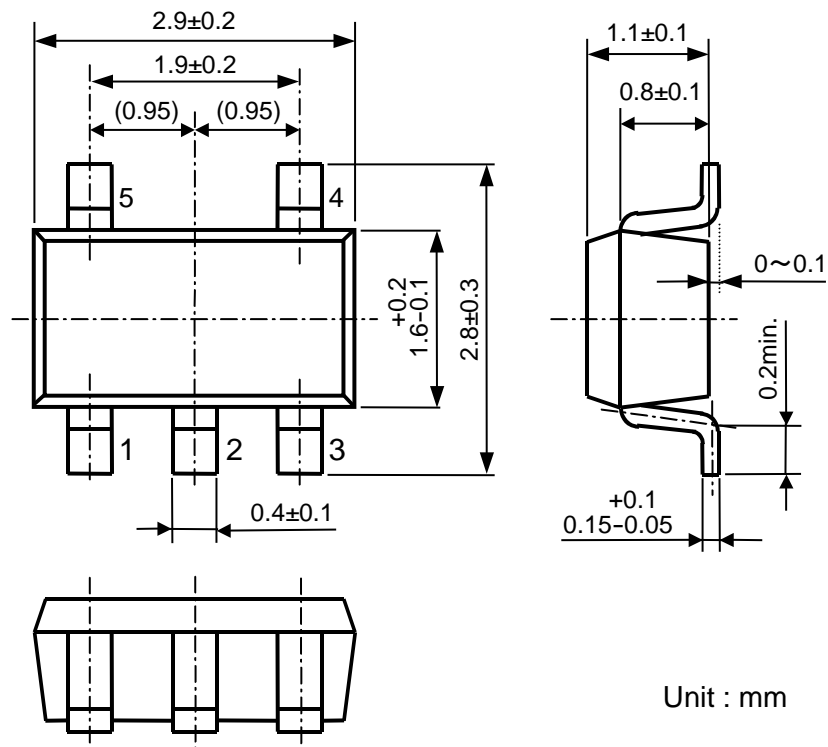

Unit : mm

SOT-23-5 Package Dimensions

MARK SPECIFICATION (SOT-23-5)

①②③: Product Code ... Refer to MARK SPECIFICATION TABLE (SOT-23-5)

④⑤: Lot Number ... Alphanumeric Serial Number

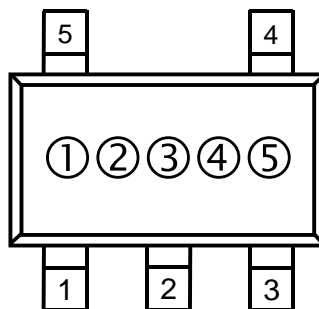

SOT-23-5 Mark Specification

RP402x

NO.EA-317-160509

MARK SPECIFICATION TABLE (SOT-23-5)**RP402N Mark Specification Table**

Product Name	①②③	Product Name	①②③	V _{SET}
RP402N181E	BA 0	RP402N181F	BE 0	1.8 V
RP402N191E	BA 1	RP402N191F	BE 1	1.9 V
RP402N201E	BA 2	RP402N201F	BE 2	2.0 V
RP402N211E	BA 3	RP402N211F	BE 3	2.1 V
RP402N221E	BA 4	RP402N221F	BE 4	2.2 V
RP402N231E	BA 5	RP402N231F	BE 5	2.3 V
RP402N241E	BA 6	RP402N241F	BE 6	2.4 V
RP402N251E	BA 7	RP402N251F	BE 7	2.5 V
RP402N261E	BA 8	RP402N261F	BE 8	2.6 V
RP402N271E	BA 9	RP402N271F	BE 9	2.7 V
RP402N281E	BB 0	RP402N281F	BF 0	2.8 V
RP402N291E	BB 1	RP402N291F	BF 1	2.9 V
RP402N301E	BB 2	RP402N301F	BF 2	3.0 V
RP402N311E	BB 3	RP402N311F	BF 3	3.1 V
RP402N321E	BB 4	RP402N321F	BF 4	3.2 V
RP402N331E	BB 5	RP402N331F	BF 5	3.3 V
RP402N341E	BB 6	RP402N341F	BF 6	3.4 V
RP402N351E	BB 7	RP402N351F	BF 7	3.5 V
RP402N361E	BB 8	RP402N361F	BF 8	3.6 V
RP402N371E	BB 9	RP402N371F	BF 9	3.7 V
RP402N381E	BC 0	RP402N381F	BG 0	3.8 V
RP402N391E	BC 1	RP402N391F	BG 1	3.9 V
RP402N401E	BC 2	RP402N401F	BG 2	4.0 V
RP402N411E	BC 3	RP402N411F	BG 3	4.1 V
RP402N421E	BC 4	RP402N421F	BG 4	4.2 V
RP402N431E	BC 5	RP402N431F	BG 5	4.3 V
RP402N441E	BC 6	RP402N441F	BG 6	4.4 V
RP402N451E	BC 7	RP402N451F	BG 7	4.5 V
RP402N461E	BC 8	RP402N461F	BG 8	4.6 V
RP402N471E	BC 9	RP402N471F	BG 9	4.7 V
RP402N481E	BD 0	RP402N481F	BH 0	4.8 V
RP402N491E	BD 1	RP402N491F	BH 1	4.9 V
RP402N501E	BD 2	RP402N501F	BH 2	5.0 V
RP402N511E	BD 3	RP402N511F	BH 3	5.1 V
RP402N521E	BD 4	RP402N521F	BH 4	5.2 V
RP402N531E	BD 5	RP402N531F	BH 5	5.3 V
RP402N541E	BD 6	RP402N541F	BH 6	5.4 V
RP402N551E	BD 7	RP402N551F	BH 7	5.5 V

MARK SPECIFICATION TABLE (SOT-23-5) (continued)

RP402N Mark Specification Table

Product Name	①②③	Product Name	①②③	V _{SET}
RP402N181G	B J 0	RP402N181H	B N 0	1.8 V
RP402N191G	B J 1	RP402N191H	B N 1	1.9 V
RP402N201G	B J 2	RP402N201H	B N 2	2.0 V
RP402N211G	B J 3	RP402N211H	B N 3	2.1 V
RP402N221G	B J 4	RP402N221H	B N 4	2.2 V
RP402N231G	B J 5	RP402N231H	B N 5	2.3 V
RP402N241G	B J 6	RP402N241H	B N 6	2.4 V
RP402N251G	B J 7	RP402N251H	B N 7	2.5 V
RP402N261G	B J 8	RP402N261H	B N 8	2.6 V
RP402N271G	B J 9	RP402N271H	B N 9	2.7 V
RP402N281G	B K 0	RP402N281H	B P 0	2.8 V
RP402N291G	B K 1	RP402N291H	B P 1	2.9 V
RP402N301G	B K 2	RP402N301H	B P 2	3.0 V
RP402N311G	B K 3	RP402N311H	B P 3	3.1 V
RP402N321G	B K 4	RP402N321H	B P 4	3.2 V
RP402N331G	B K 5	RP402N331H	B P 5	3.3 V
RP402N341G	B K 6	RP402N341H	B P 6	3.4 V
RP402N351G	B K 7	RP402N351H	B P 7	3.5 V
RP402N361G	B K 8	RP402N361H	B P 8	3.6 V
RP402N371G	B K 9	RP402N371H	B P 9	3.7 V
RP402N381G	B L 0	RP402N381H	B Q 0	3.8 V
RP402N391G	B L 1	RP402N391H	B Q 1	3.9 V
RP402N401G	B L 2	RP402N401H	B Q 2	4.0 V
RP402N411G	B L 3	RP402N411H	B Q 3	4.1 V
RP402N421G	B L 4	RP402N421H	B Q 4	4.2 V
RP402N431G	B L 5	RP402N431H	B Q 5	4.3 V
RP402N441G	B L 6	RP402N441H	B Q 6	4.4 V
RP402N451G	B L 7	RP402N451H	B Q 7	4.5 V
RP402N461G	B L 8	RP402N461H	B Q 8	4.6 V
RP402N471G	B L 9	RP402N471H	B Q 9	4.7 V
RP402N481G	B M 0	RP402N481H	B R 0	4.8 V
RP402N491G	B M 1	RP402N491H	B R 1	4.9 V
RP402N501G	B M 2	RP402N501H	B R 2	5.0 V
RP402N511G	B M 3	RP402N511H	B R 3	5.1 V
RP402N521G	B M 4	RP402N521H	B R 4	5.2 V
RP402N531G	B M 5	RP402N531H	B R 5	5.3 V
RP402N541G	B M 6	RP402N541H	B R 6	5.4 V
RP402N551G	B M 7	RP402N551H	B R 7	5.5 V

TYPICAL CHARACTERISTICS

Note: Typical Characteristics are intended to be used as reference data; they are not guaranteed.

1) Output Voltage vs. Output Current

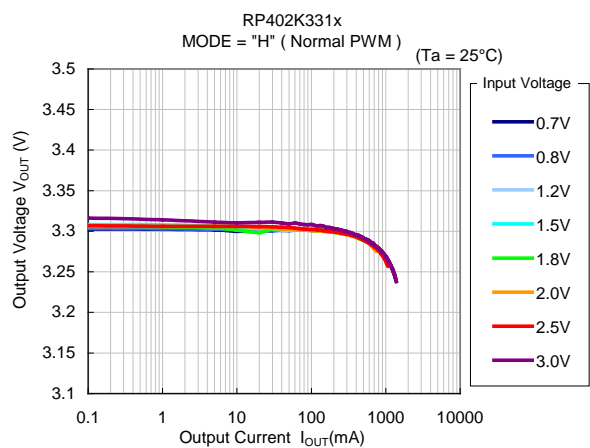
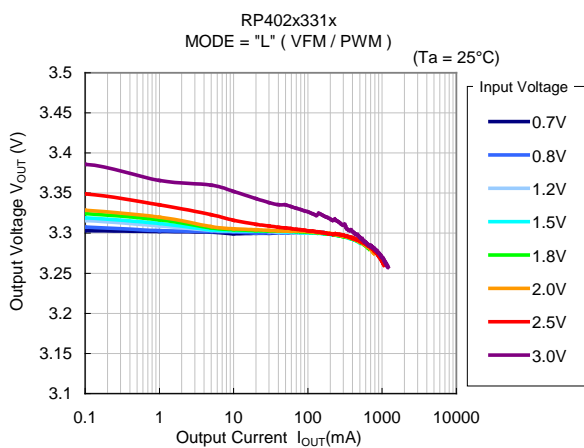
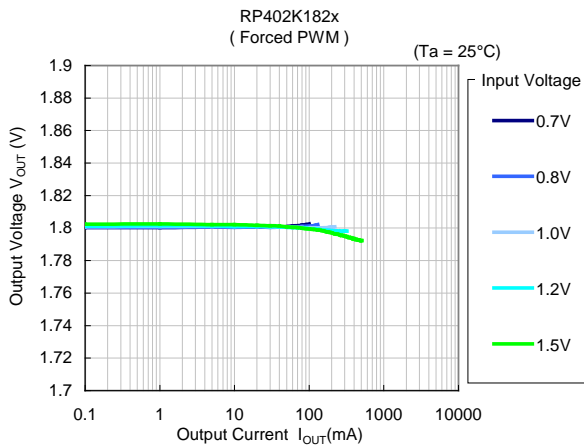
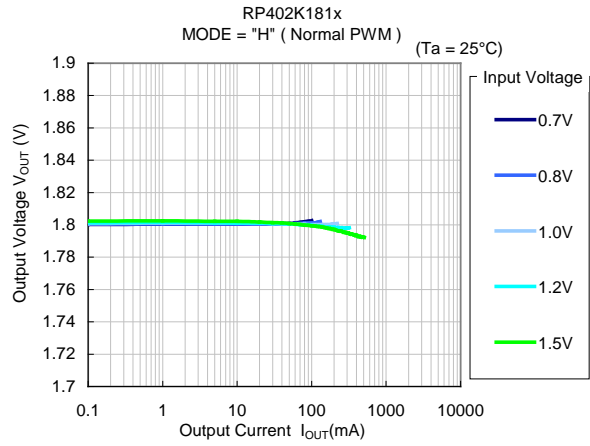
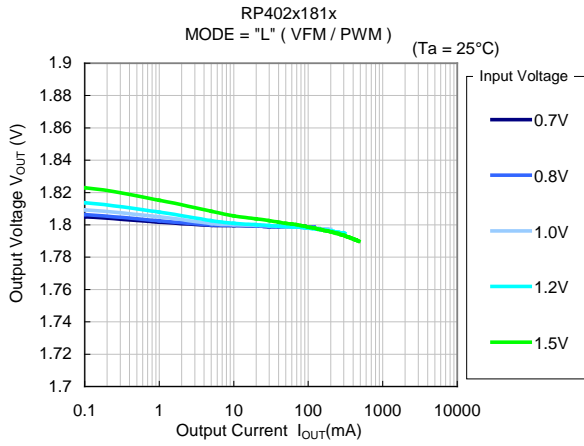

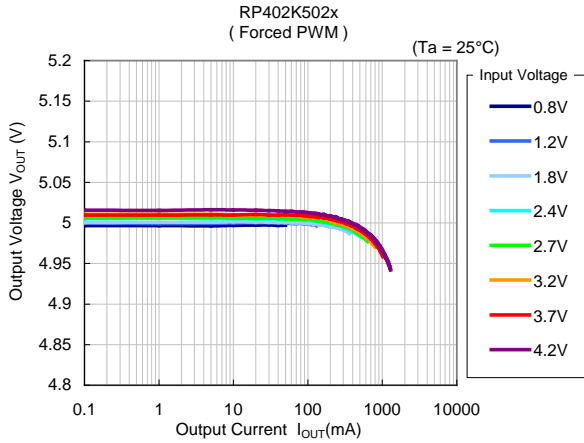
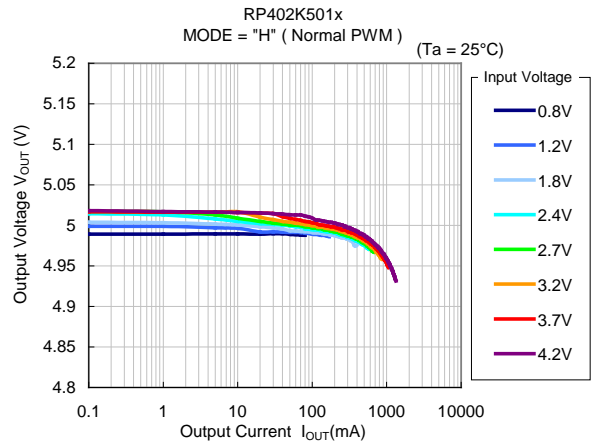
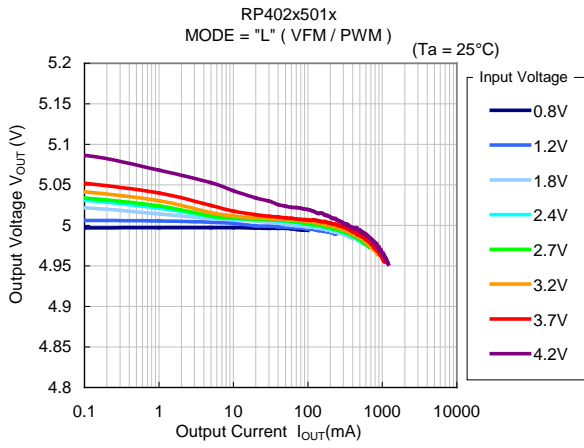
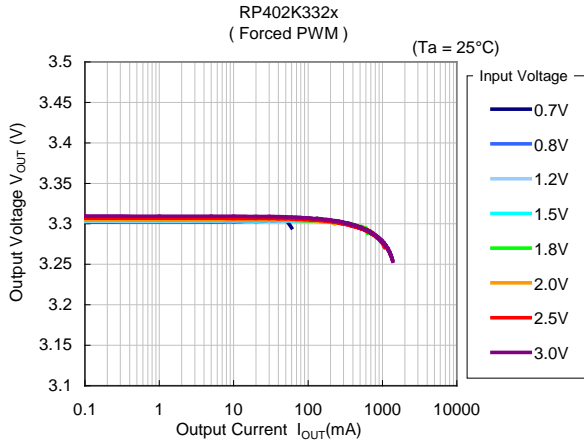

RP402x

NO.EA-317-160509

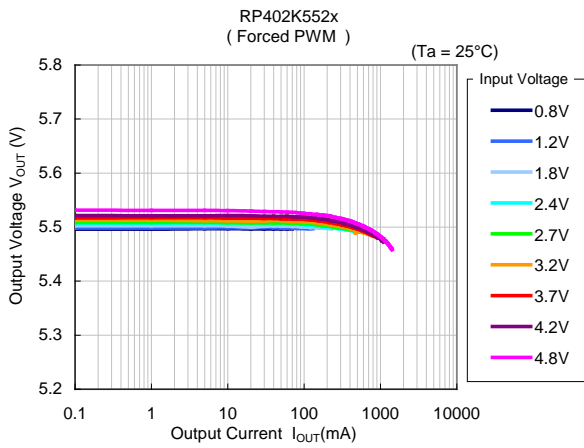
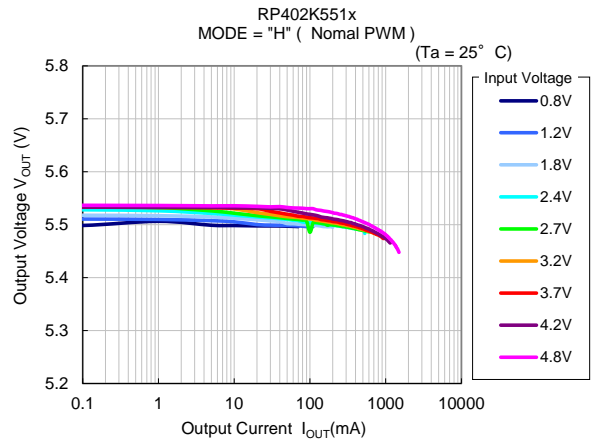
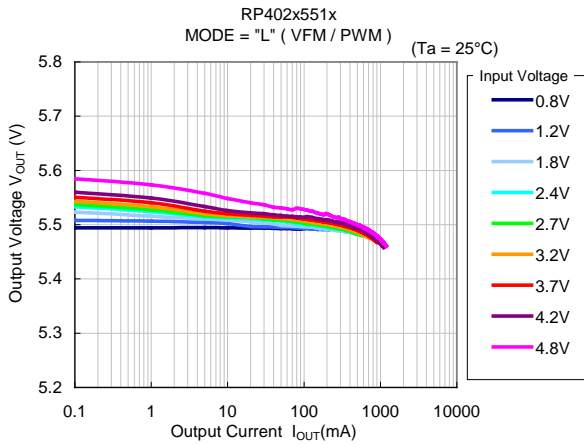

2) Efficiency vs. Output Current

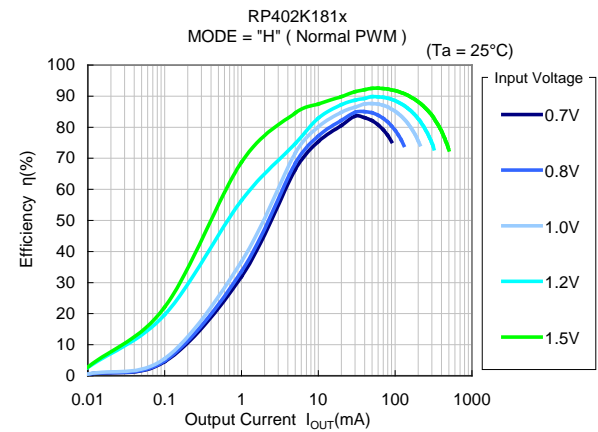
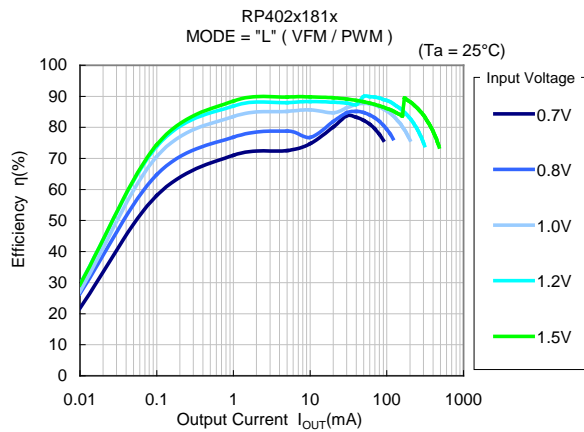

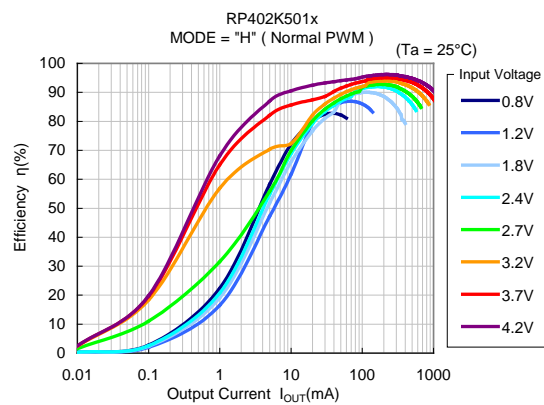
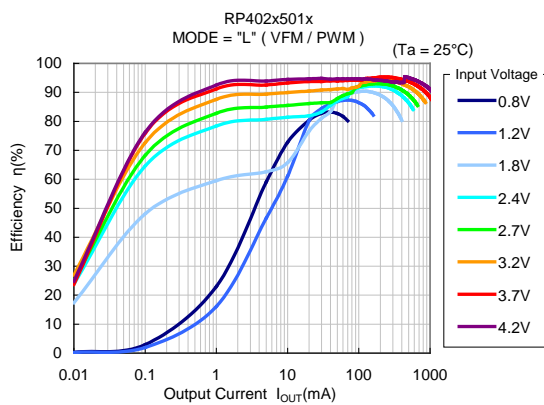
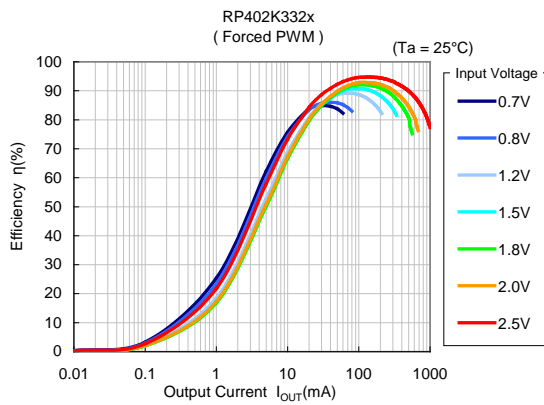
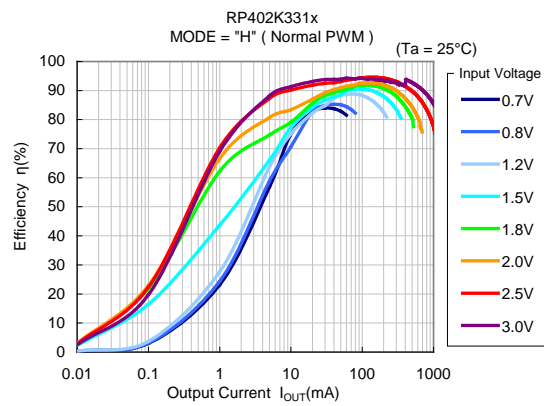
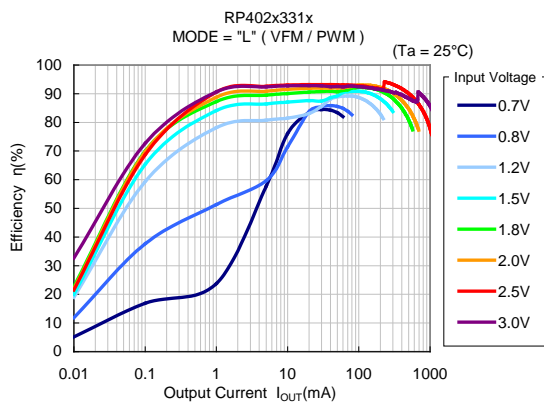
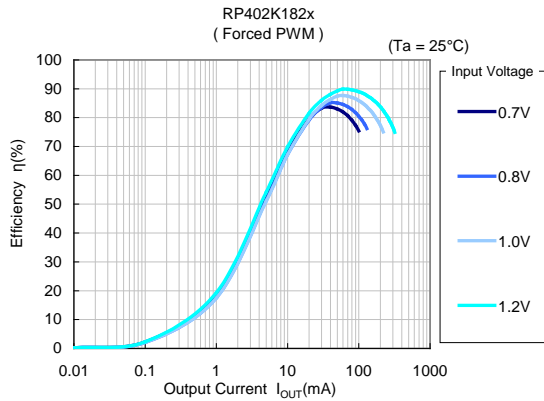

RP402x

NO.EA-317-160509

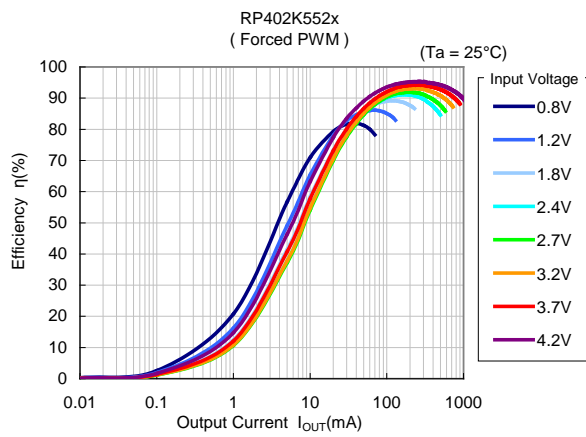
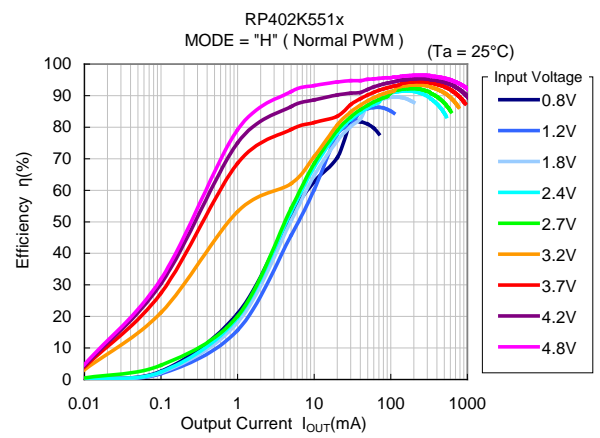
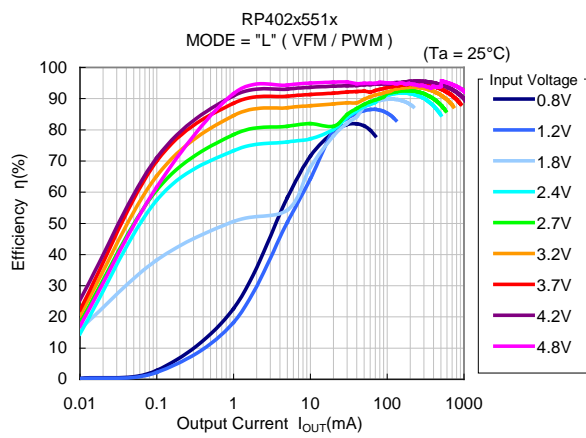
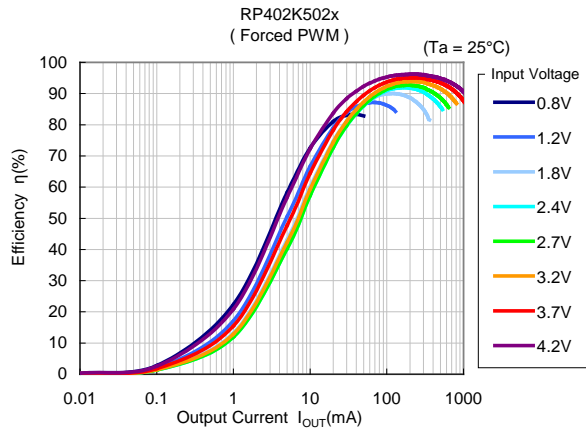

3) Standby Current vs. Ambient Temperature

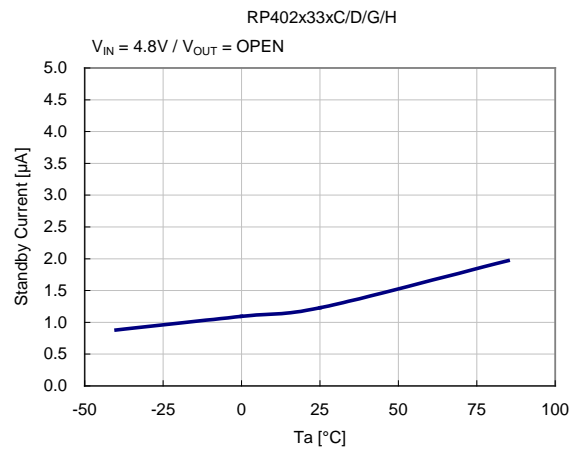
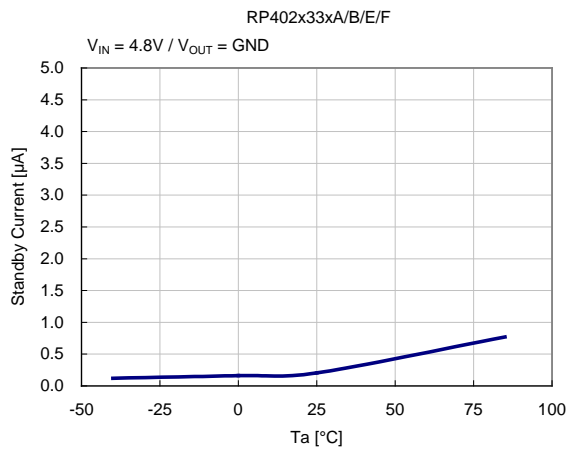

4) Supply Current 1 vs. Ambient Temperature

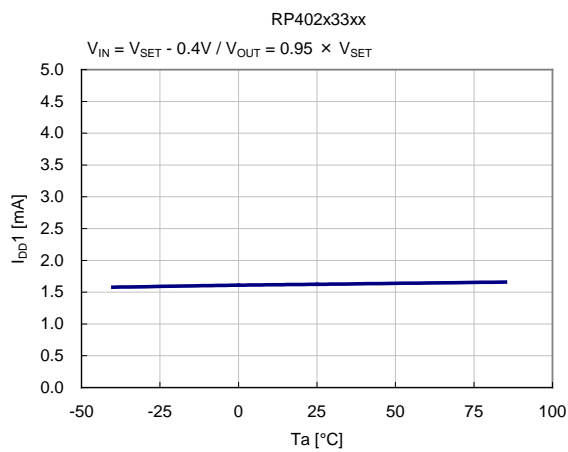

5) Supply Current 2 vs. Ambient Temperature

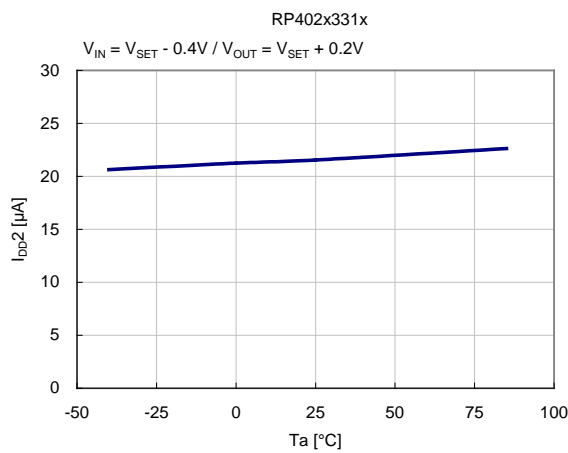

RP402x

NO.EA-317-160509

6) Start-up vs. Ambient Temperature

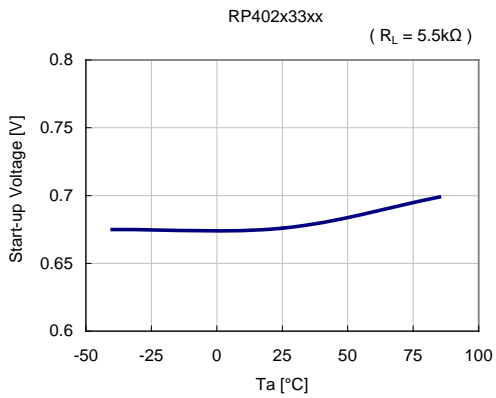

7) Hold-on Voltage vs. Ambient Temperature

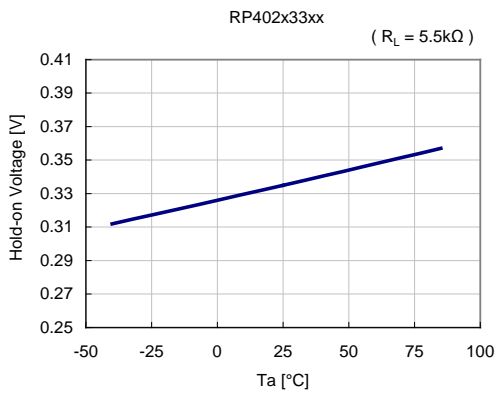

8) Oscillator Frequency vs. Ambient Temperature

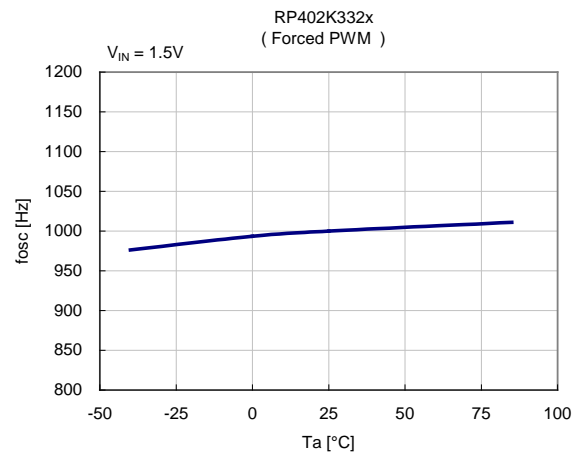
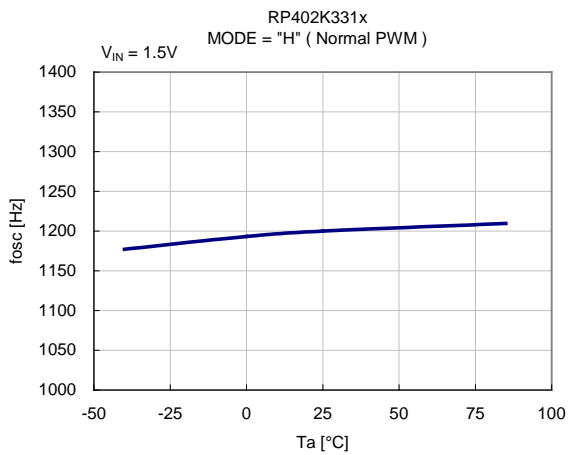

9) Maxduty vs. Ambient Temperature

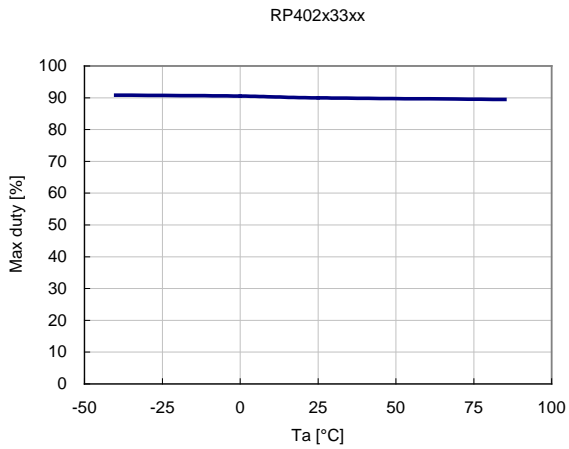

10) Lx Current Limit vs. Duty

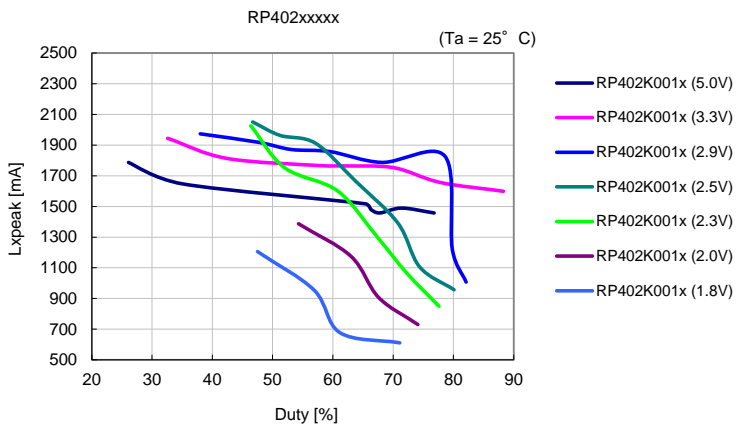

11) Lx Current Limit vs. Ambient Temperature

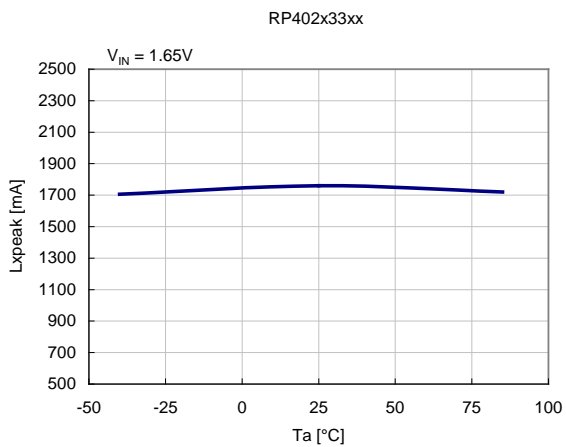

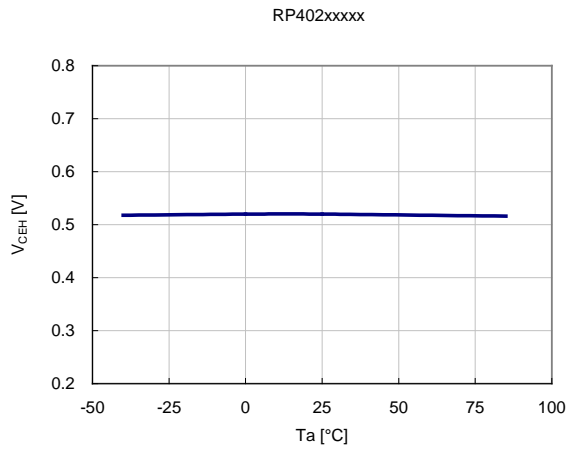
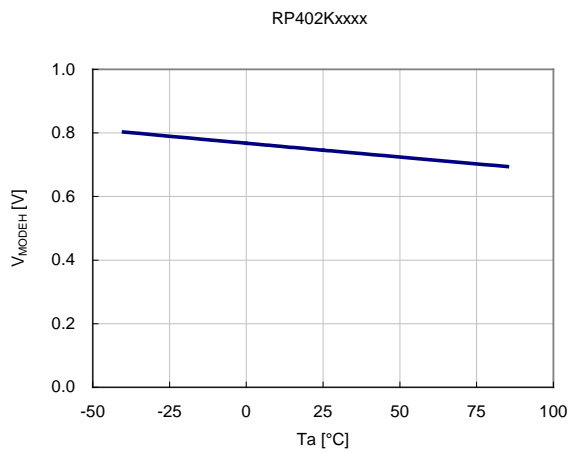
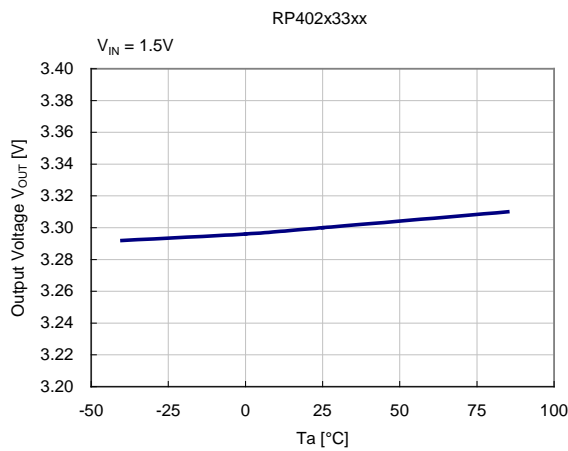
12) CE "H" Input Voltage vs. Ambient Temperature**13) MODE "H" Input Voltage vs. Ambient Temperature****14) Output Voltage vs. Ambient Temperature**

15) Feedback Voltage vs. Ambient Temperature

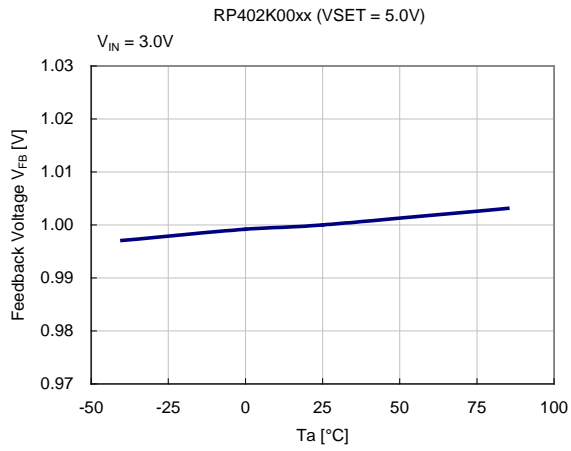

16) Start-up Waveform ($C_{OUT} = 20 \mu F$)

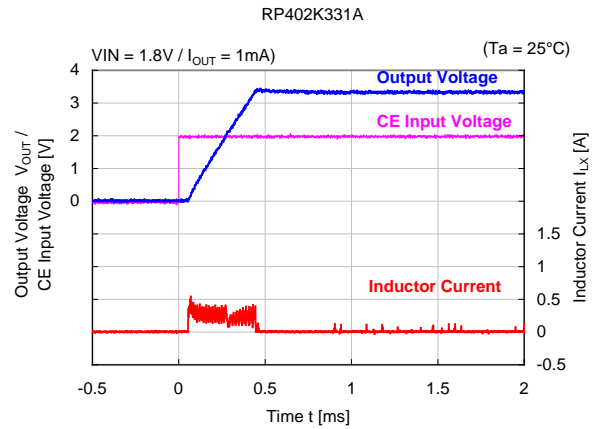
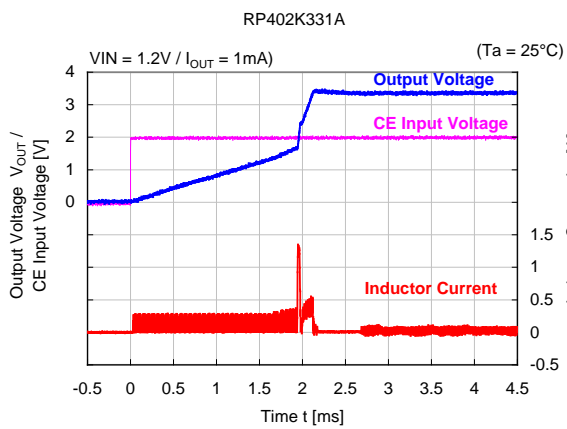

17) Load Transient Response ($C_{OUT} = 20 \mu F$)

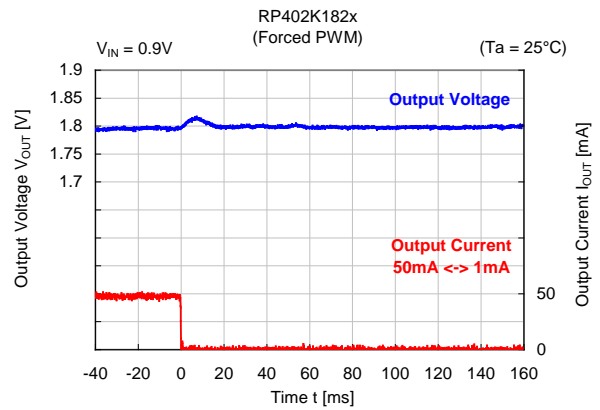
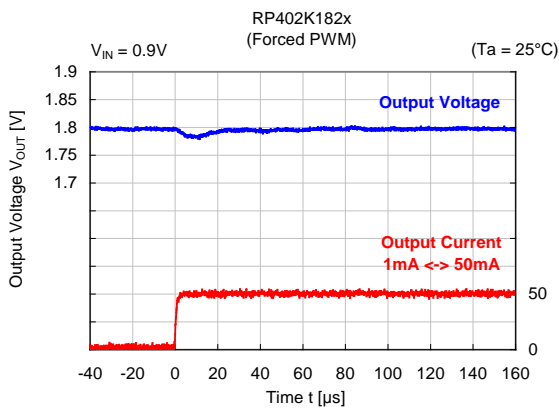
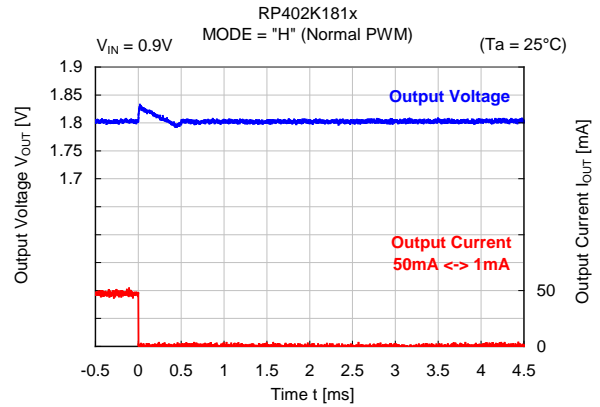
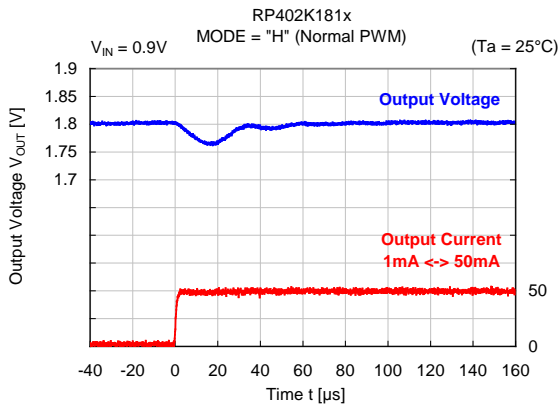
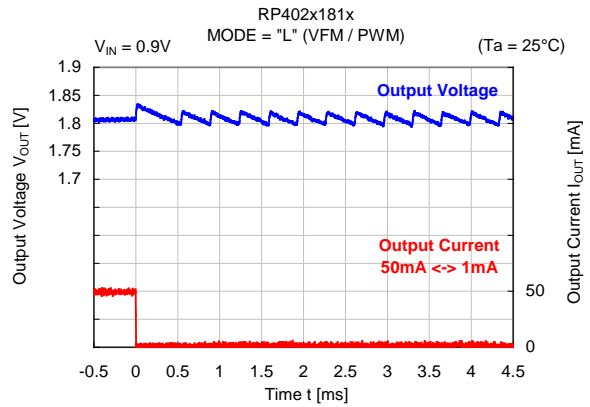
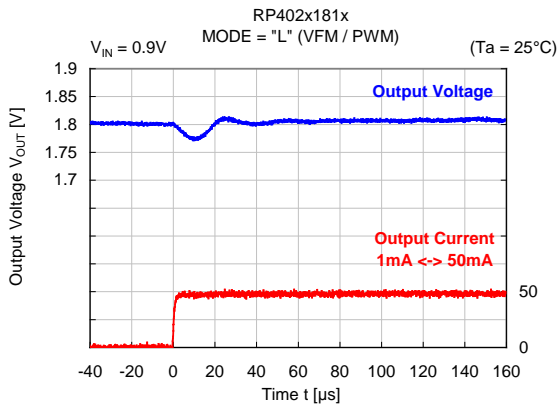

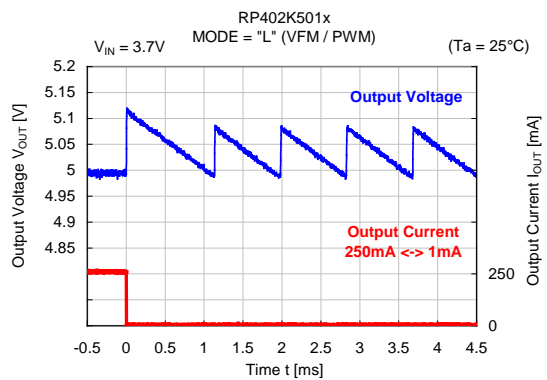
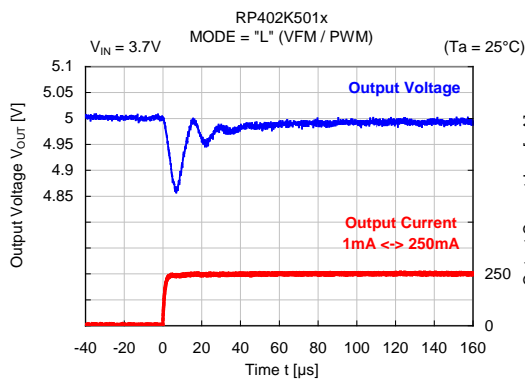
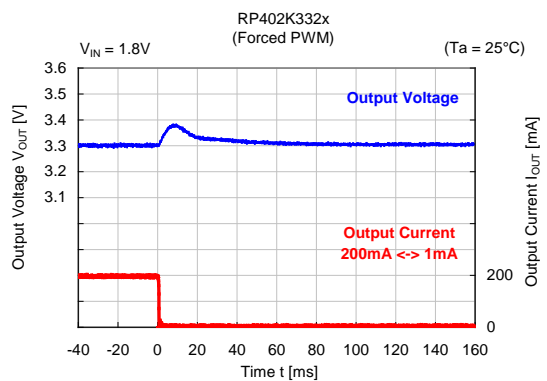
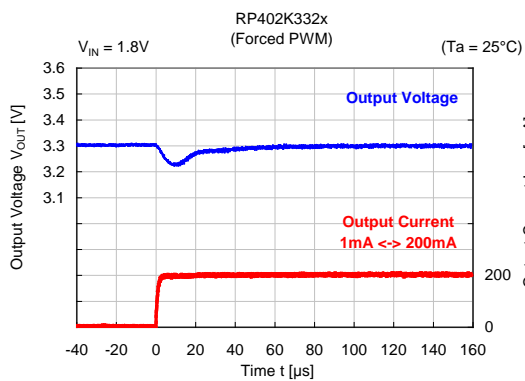
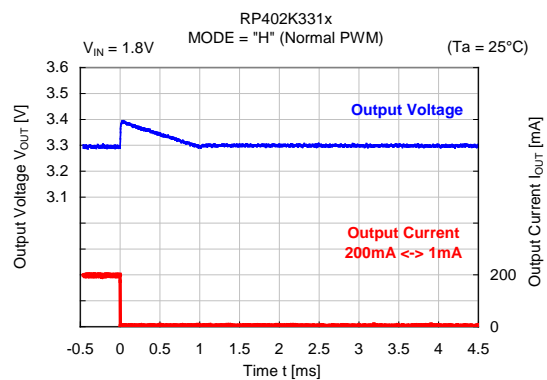
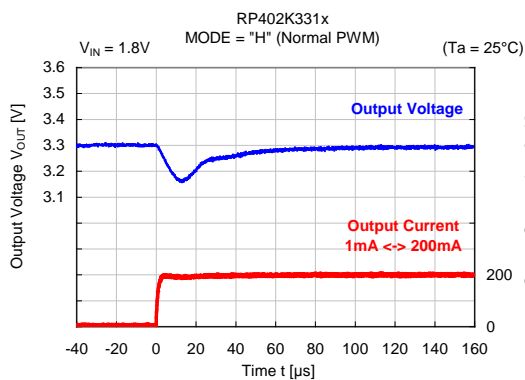
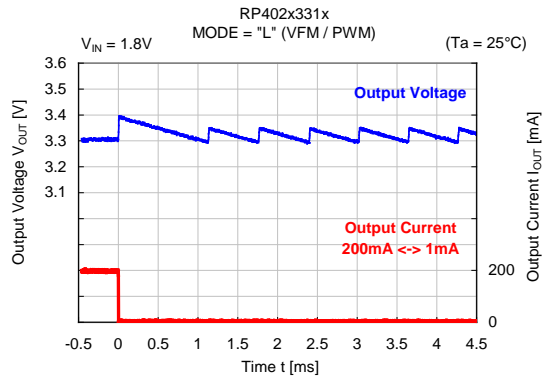
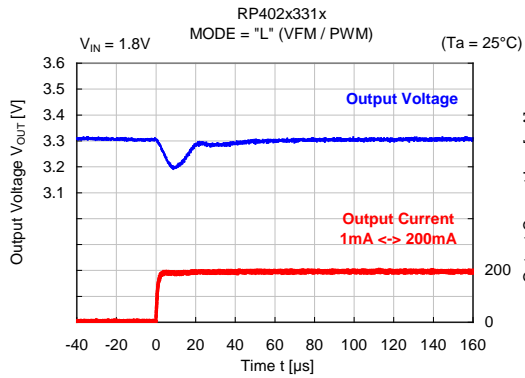

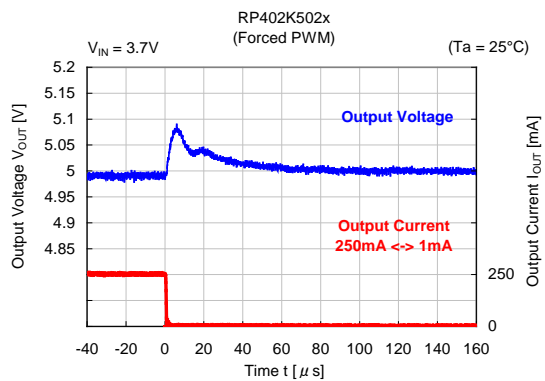
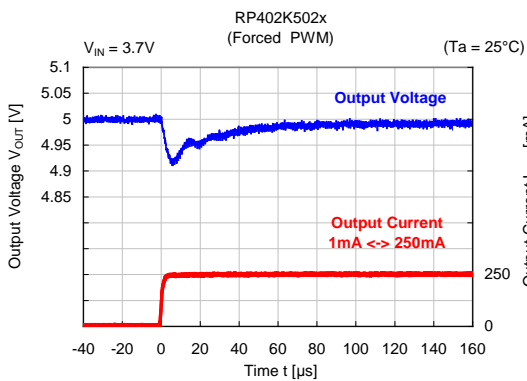
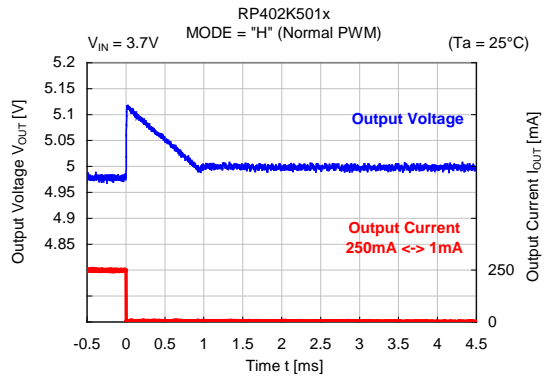
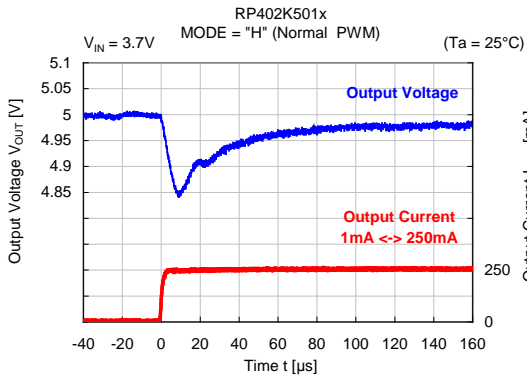

18) 出力電圧波形 ($C_{OUT} = 20 \mu F$)

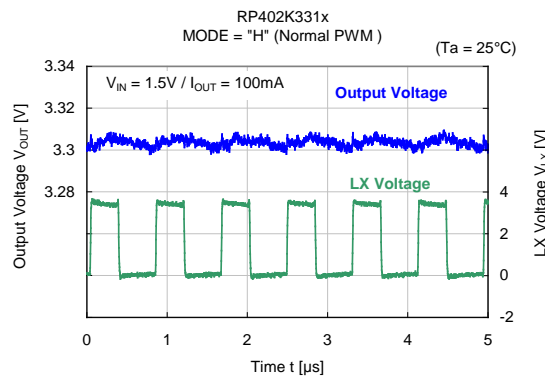
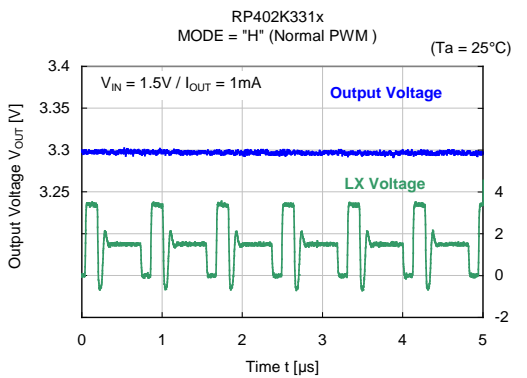
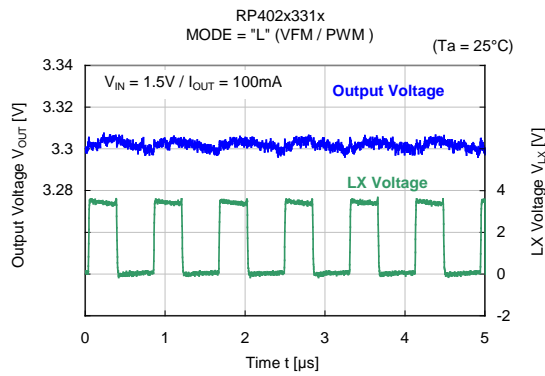
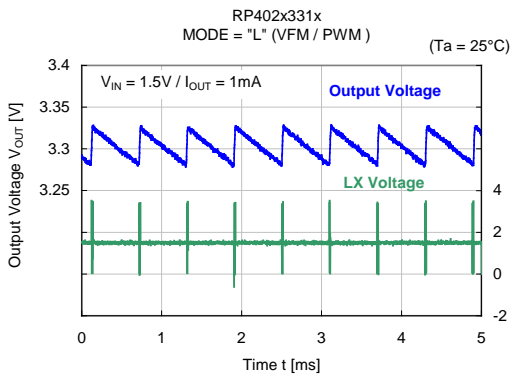

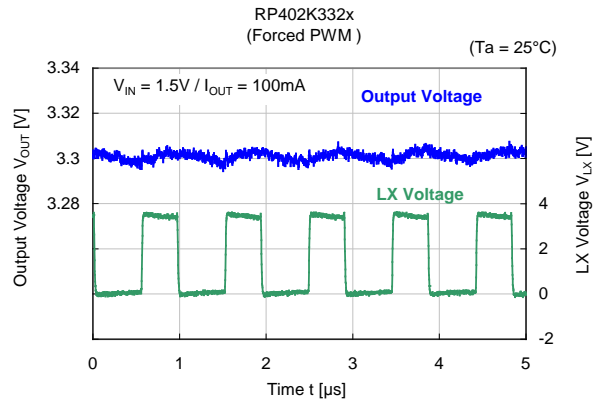
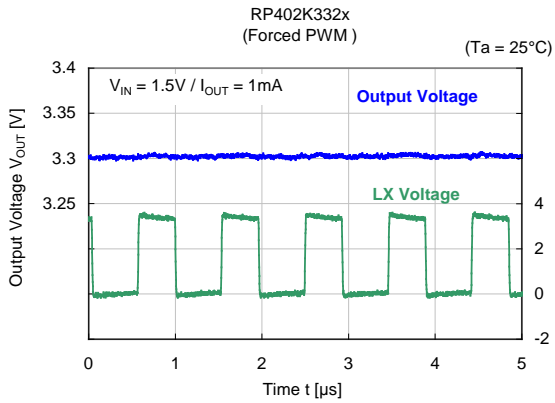

18) Mode Switching Waveform

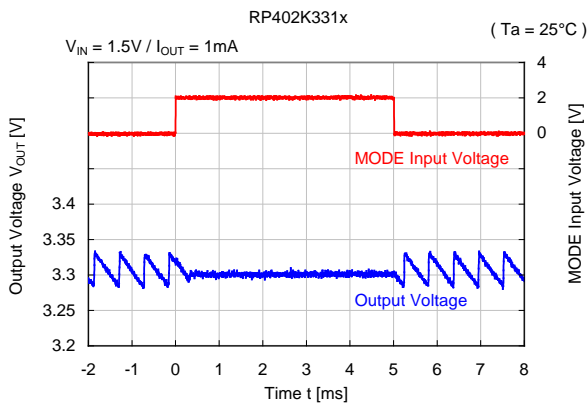

19) Bypass Switch ON Resistance

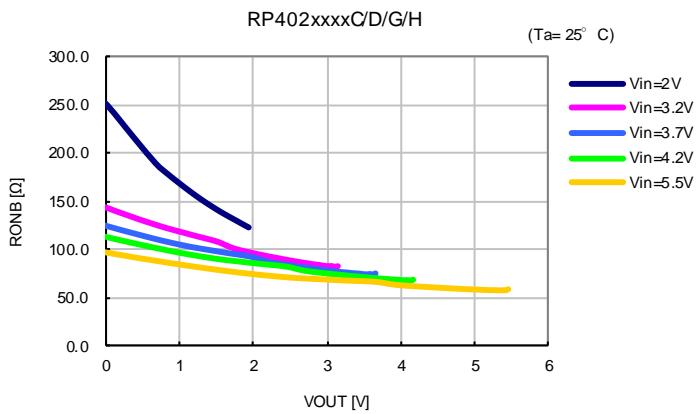

RP402x

NO.EA-317-160509

20) PWM Operable Maximum Input Voltage vs. Ambient Temperature

RP402Kxx2x: (Forced PWM)

RP402Kxx1x: MODE = "H" (Normal PWM)

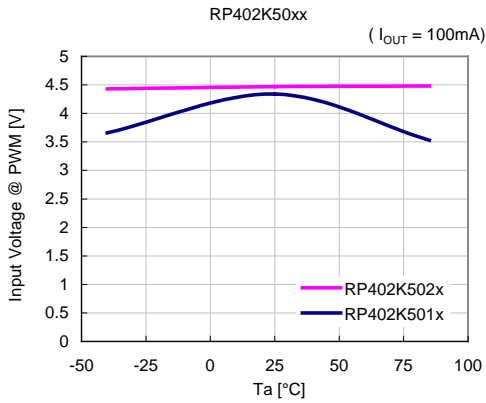
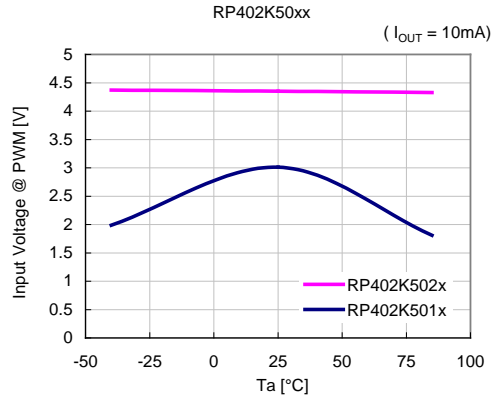
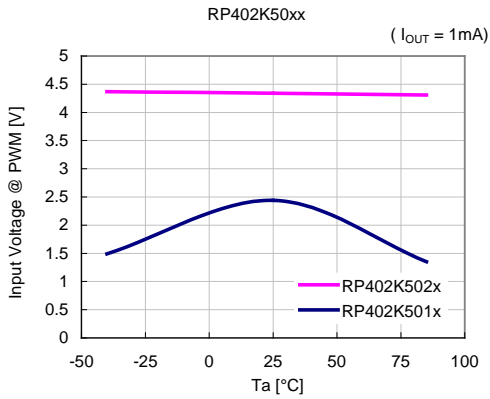

21) Reverse Current at $V_{IN} = 0$ vs. Ambient Temperature

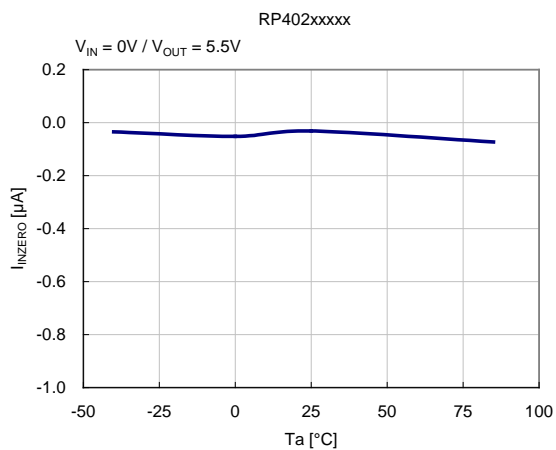

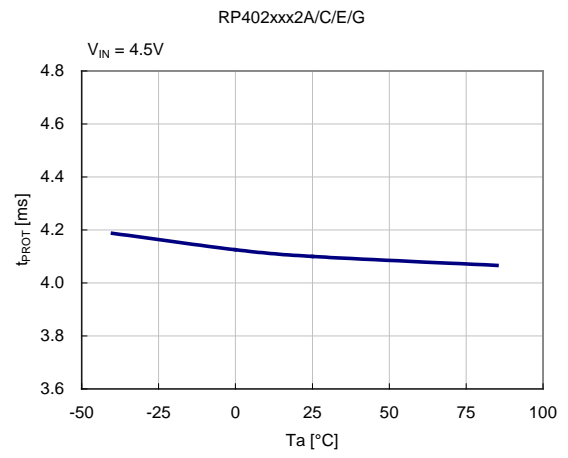
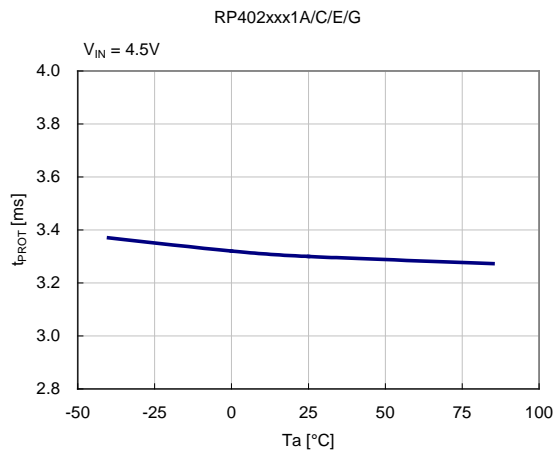
22) Latch Protection Delay Time vs. Ambient Temperature



1. The products and the product specifications described in this document are subject to change or discontinuation of production without notice for reasons such as improvement. Therefore, before deciding to use the products, please refer to Ricoh sales representatives for the latest information thereon.
2. The materials in this document may not be copied or otherwise reproduced in whole or in part without prior written consent of Ricoh.
3. Please be sure to take any necessary formalities under relevant laws or regulations before exporting or otherwise taking out of your country the products or the technical information described herein.
4. The technical information described in this document shows typical characteristics of and example application circuits for the products. The release of such information is not to be construed as a warranty of or a grant of license under Ricoh's or any third party's intellectual property rights or any other rights.
5. The products listed in this document are intended and designed for use as general electronic components in standard applications (office equipment, telecommunication equipment, measuring instruments, consumer electronic products, amusement equipment etc.). Those customers intending to use a product in an application requiring extreme quality and reliability, for example, in a highly specific application where the failure or misoperation of the product could result in human injury or death (aircraft, spacevehicle, nuclear reactor control system, traffic control system, automotive and transportation equipment, combustion equipment, safety devices, life support system etc.) should first contact us.
6. We are making our continuous effort to improve the quality and reliability of our products, but semiconductor products are likely to fail with certain probability. In order to prevent any injury to persons or damages to property resulting from such failure, customers should be careful enough to incorporate safety measures in their design, such as redundancy feature, fire containment feature and fail-safe feature. We do not assume any liability or responsibility for any loss or damage arising from misuse or inappropriate use of the products.
7. Anti-radiation design is not implemented in the products described in this document.
8. Please contact Ricoh sales representatives should you have any questions or comments concerning the products or the technical information.



Ricoh is committed to reducing the environmental loading materials in electrical devices with a view to contributing to the protection of human health and the environment.

Ricoh has been providing RoHS compliant products since April 1, 2006 and Halogen-free products since April 1, 2012.

RICOH RICOH ELECTRONIC DEVICES CO., LTD.

<http://www.e-devices.ricoh.co.jp/en/>

Sales & Support Offices

RICOH ELECTRONIC DEVICES CO., LTD.

Higashi-Shinagawa Office (International Sales)
3-32-3, Higashi-Shinagawa, Shinagawa-ku, Tokyo 140-8655, Japan
Phone: +81-3-5479-2857 Fax: +81-3-5479-0502

RICOH EUROPE (NETHERLANDS) B.V.

Semiconductor Support Centre
Prof. W.H. Keesomlaan 1, 1183 DJ Amstelveen, The Netherlands
Phone: +31-20-5474-309

RICOH INTERNATIONAL B.V. - German Branch

Semiconductor Sales and Support Centre
Oberrather Strasse 6, 40472 Düsseldorf, Germany
Phone: +49-211-6546-0

RICOH ELECTRONIC DEVICES KOREA CO., LTD.

3F, Haesung Bldg, 504, Teheran-ro, Gangnam-gu, Seoul, 135-725, Korea
Phone: +82-2-2135-5700 Fax: +82-2-2051-5713

RICOH ELECTRONIC DEVICES SHANGHAI CO., LTD.

Room 403, No.2 Building, No.690 Bibo Road, Pu Dong New District, Shanghai 201203, People's Republic of China
Phone: +86-21-5027-3200 Fax: +86-21-5027-3299

RICOH ELECTRONIC DEVICES CO., LTD.

Taipei office
Room 109, 10F-1, No.51, Hengyang Rd., Taipei City, Taiwan (R.O.C.)
Phone: +886-2-2313-1621/1622 Fax: +886-2-2313-1623

Mouser Electronics

Authorized Distributor

Click to View Pricing, Inventory, Delivery & Lifecycle Information:

Ricoh Electronics:

[RP402K502A-TR](#) [RP402N501E-TR-FE](#) [RP402K001A-TR](#) [RP402K001B-TR](#) [RP402K502B-TR](#) [RP402K332A-TR](#)
[RP402K181C-TR](#) [RP402K001C-TR](#) [RP402K001D-TR](#) [RP402K551A-TR](#) [RP402K552A-TR](#) [RP402K501B-TR](#)
[RP402K501A-TR](#) [RP402N181E-TR-FE](#) [RP402N331E-TR-FE](#) [RP402K002B-TR](#)



Компания «ЭлектроПласт» предлагает заключение долгосрочных отношений при поставках импортных электронных компонентов на взаимовыгодных условиях!

Наши преимущества:

- Оперативные поставки широкого спектра электронных компонентов отечественного и импортного производства напрямую от производителей и с крупнейших мировых складов;
- Поставка более 17-ти миллионов наименований электронных компонентов;
- Поставка сложных, дефицитных, либо снятых с производства позиций;
- Оперативные сроки поставки под заказ (от 5 рабочих дней);
- Экспресс доставка в любую точку России;
- Техническая поддержка проекта, помощь в подборе аналогов, поставка прототипов;
- Система менеджмента качества сертифицирована по Международному стандарту ISO 9001;
- Лицензия ФСБ на осуществление работ с использованием сведений, составляющих государственную тайну;
- Поставка специализированных компонентов (Xilinx, Altera, Analog Devices, Intersil, Interpoint, Microsemi, Aeroflex, Peregrine, Syfer, Eurofarad, Texas Instrument, Miteq, Cobham, E2V, MA-COM, Hittite, Mini-Circuits, General Dynamics и др.);

Помимо этого, одним из направлений компании «ЭлектроПласт» является направление «Источники питания». Мы предлагаем Вам помощь Конструкторского отдела:

- Подбор оптимального решения, техническое обоснование при выборе компонента;
- Подбор аналогов;
- Консультации по применению компонента;
- Поставка образцов и прототипов;
- Техническая поддержка проекта;
- Защита от снятия компонента с производства.



Как с нами связаться

Телефон: 8 (812) 309 58 32 (многоканальный)

Факс: 8 (812) 320-02-42

Электронная почта: org@eplast1.ru

Адрес: 198099, г. Санкт-Петербург, ул. Калинина, дом 2, корпус 4, литера А.