

## MICRO SWITCH Global Miniature Limit Switches

GLC | GLD | GLE Series

**107147**

Issue 17

**Datasheet**



### DESCRIPTION

Honeywell MICRO SWITCH GLS miniature limit switch family offers a wide range of products for global solutions. These durable and reliable limit switches are suitable for many industrial applications, agriculture equipment, transportation equipment, and other applications requiring an environmentally sealed (IP and NEMA) switch.

The compact housings are often ideal for equipment where space is at a premium. The extensive product range is available in three different housing types; metal housing, plastic housing or a three conduit metal housing which are mounting compatible to EN50047. A wide range of actuators, contact blocks, and conduit/connectivity options enhance the product offering.

In today's demanding age of logic-level controls, electromechanical switches are frequently used to interface with PLCs and other logic level devices. GLS limit switches offer an option for gold-plated contacts for the standard switch. This option promotes the switch reliability for logic-level applications.

### VALUE TO CUSTOMERS

- Meets EN50047 mounting standards and EN/IEC electrical standards for world-wide use
- Large existing install base and channel allows for quick delivery worldwide
- Wide range of actuators and circuitry options in same footprint
- Certified for global use with CCC<sup>1</sup>, CSA, CE, and UL acceptance

### DIFFERENTIATION

- Modular design of limit switch (heads/actuators, bodies, and contact blocks) allows for rapid customization and delivery
- Removable contact block for wiring ease
- Galvanically isolated contacts for controlling two separate circuits

### FEATURES

- Designed to EN50047 standard
- Metal housing or double-insulated plastic housing for indoor and outdoor applications
- Wide range of actuator heads and levers
- Heads can be positioned at 90° increments for design flexibility. Side rotary actuator heads can be factory set for CW, CCW, or CW and CCW actuation
- Certified for global applications: CE, UL, CSA, CCC<sup>1</sup>
- Conforms to CE, EN50047, IEC/EN 60947-5-1; CSA C22.2 #14; UL 508; CCC<sup>1</sup> GB14048.5, EN45545-2 (GLC/GLE)
- Sealed to IP66 and NEMA/UL 1, 4, 12, and 13
- -40 °C [-40 °F] standard construction for side rotary and plunger actuated switches suitable for many severe outdoor environments
- Dual bearing design on side rotary actuators reduces side loading and enhances mechanical life
- Variety of NC and NO double-break snap-action or slow-action contact options
- Silver contacts for power switching or gold-plated contacts for low energy loads
- Normally closed contacts are positive opening  $\odot$ , and conform to EN/IEC 60947-5-1-3 to provide forced opening of the normally closed contact. Each contact throw is electrically isolated to accept different voltages (Form Zb contacts). Double pole double throw (2NC/2NO) contact option require same polarity for each pole. (Form Za for each pole)
- Contact blocks are available as snap action or slow action
- Mechanical life up to 10 million operations

### POTENTIAL APPLICATIONS

- Passenger elevators
- Commercial appliances
- Escalators/moving stairs
- Scissor/platform lifts
- Material handling
- Machine tool equipment
- Off-road equipment

### PORTFOLIO

The GLC Series, GLD Series, and GLE Series are a segment of Honeywell's global limit switch offering. The global limit switch products also include the GLA Series, the GLL Series, the NGC Series, and SZL-VL series. In addition to the global limit switch series, Honeywell provides a comprehensive line of medium duty industrial limit switches (CE Series, E6/V6 Series, LS Series) and heavy-duty **HDLS Series (Heavy Duty Limit Switch)**.

<sup>1</sup>CCC certification is not available on the GL Series Switches sold within Europe, Middle East, and Africa. Option for CCC certification in these regions is available upon request.

# MICRO SWITCH Global Miniature Limit Switches, GLC | GLD | GLE Series

**Table 1. Specifications**

| Characteristic           | Parameter  |
|--------------------------|--|
| Housing material         | GLC Series and GLE Series: Electrostatic epoxy coated zinc<br>GLD Series: High-strength glass re-enforced thermoplastic                            |
| Actuators                | Side rotary, top pin plunger, top roller plunger, top roller lever, top wobble actuator  |
| Termination              | 0.5-14 NPT, PG 13,5, 20 mm, PF 1/2, Deutsch style 4-pin connector<br>other cable/connector options available, contact the Honeywell Representative |
| Contact options*         | GLC metal housing and GLD plastic housing: 1NC/1NO, 2NC, 2NO<br>GLE metal housing, 1NC/1NO, 2NC, 2NO, 2NC/2NO                                      |
| Contact type             | snap-action, slow-action break-before-make (BBM), slow-action make-before-break (MBB), slow action   |
| Contact material         | silver (standard), gold plated (low-energy applications)   |
| Thermal current (Ith)    | 10 A   |
| Rated insulation voltage | 300 V  |
| Rated impulse voltage    | 2.5 kV   |
| Sealing                  | NEMA 1, 4, 12, 13; IP66  |
| Operating temperature    | -40 °C to 85 °C [-40 °F to 185 °F]   |
| Mechanical life          | Up to 10 million cycles  |
| Pollution code           | 3  |
| Max. actuation frequency | 250 operations/minute; 100 operations/minute (wobbles)   |
| Shock                    | 50 g per IEC 60068-2-27  |
| Vibration                | 10 g per IEC 60068-2-6   |
| Approvals                | CE, UL, CSA and CCC <sup>1</sup>   |
| Conforming to standards  | CE, EN50047, IEC/EN 60947-5-1; CSA C22.2 #14; UL 508; CCC <sub>1</sub> , GB14048.5; EN45545-2 (GLC/GLE)  |

\*All normally closed contacts are positive opening (→).

The two contact elements are Zb (electrically separated) except the 2NC/2NO contacts requires same polarity each pole (Za).

<sup>1</sup>CCC certification is not available on the GL Series Switches sold within Europe, Middle East, and Africa. Option for CCC certification in these regions is available upon request.



**Table 2. Electrical Rating**

IEC 60947-5-1 (EN60947-5-1) AC 15, A300; DC 13, Q300

| Silver Contacts |            |      |       |            |            |      |       | Gold Contacts                         |
|-----------------|------------|------|-------|------------|------------|------|-------|---------------------------------------|
| ac              |            |      |       | dc         |            |      |       | 1 V 10 µA min.<br>50 V 100 mA<br>max. |
| A300<br>Ue      | AC15<br>Ie | VA   |       | Q300<br>Ue | DC13<br>Ie | VA   |       |                                       |
| Volts           | Amps       | Make | Break | Volts      | Amps       | Make | Break |                                       |
| 120             | 6          | 7200 | 720   | 125        | 0.55       | 69   | 69    |                                       |
| 240             | 3          | 7200 | 720   | 250        | 0.27       | 69   | 69    |                                       |

# MICRO SWITCH Global Miniature Limit Switches, GLC | GLD | GLE Series

Figure 1. Product Nomenclature

| GL   | C                             | A                   | 01   | A1A  | L  |   |
|--|-------------------------------|---------------------|--|--|--|---|
| Switch Type                                    | Body                          | Conduit             | Basic Switch                                   | Head/Actuator  | Modification Codes<br>For Actuator types beginning with A*         |   |
| <b>GLS Series</b><br>Global<br>Limit<br>Switch | <b>C</b> Metal, miniature     | <b>A</b> 1/2-14 NPT | <b>01</b> SPDT snap action                     | <b>A1A</b> Side rotary, fixed, 19 mm x 6 mm nylon roller   | <b>E7B</b> Wobble, coil spring                                     | <b>1</b> CW rotation only                   |
|  | <b>D</b> Plastic, miniature   | <b>B</b> PG 13,5    | <b>03</b> SPDT, BBM slow acting                | <b>A1B</b> Side rotary, fixed, 19 mm x 6 mm steel roller   | <b>F<sup>Δ</sup></b> Adj. top roller lever, Ø27,3 mm x 5 mm roller | <b>2</b> CCW rotation only                  |
|  | <b>E</b> Metal, three conduit | <b>C</b> 20 mm      | <b>04</b> SPDT, MBB slow acting                | <b>A2A</b> Side rotary, adjust., 19 mm x 6 mm nylon roller | <b>K8A</b> Cat whisker, 140 mm                                     | <b>3</b> Lever to right                     |
|  |                               |                     | <b>05</b> DPST, 2NO slow acting                | <b>A2B</b> Side rotary, adjust., 19 mm x 6 mm steel roller | <b>K8B</b> Cat whisker, 190 mm                                     | <b>4</b> Lever to left                      |
|  |                               |                     | <b>06</b> DPST, 2NC slow acting                | <b>A4J</b> Side rotary, adjust., 140 mm aluminum rod       | <b>K8D</b> Cat whisker, 165 mm                                     | <b>5</b> Lever to mounting surf.            |
|  |                               |                     | <b>07</b> SPDT, snap action, gold cont.        | <b>A4L</b> Side rotary, adjust., 200 mm aluminum rod       | <b>A1</b> Side rotary, fixed, no roller                            | for Actuator/Type C                         |
|  |                               |                     | <b>24</b> DPDT, snap action, Body E            | <b>A5A</b> Side rotary, offset, 19 mm x 6 mm nylon roller  | <b>A2</b> Side rotary, adjustable, no roller                       | <b>6</b> Roller perpendicular to mtg. surf. |
|  |                               |                     | <b>32</b> DPDT, snap action, gold cont. Body E | <b>A5B</b> Side rotary, offset, 19 mm x 6 mm steel roller  | <b>A1Y</b> Side rotary, fixed, 50 mm x 10 mm rubber roller         |   |
|  |                               |                     | <b>33</b> SPDT, BBM slow acting, gold contacts | <b>A9A</b> Side rotary, conveyor lever                     | <b>A2Y</b> Side rotary, adj., 50 mm x 10 mm rubber roller          | for Actuator/Type D                         |
|  |                               |                     | <b>34</b> SPDT, MBB slow acting, gold contacts | <b>B</b> Top pin plunger                                   | <sup>Δ</sup> Available with D style body (plastic) only.           | <b>4</b> Lever to right, hinge to left      |
|  |                               |                     | <b>35</b> DPST, 2NO slow acting, gold contacts | <b>C</b> Top roller plunger                                |  |   |
|  |                               |                     | <b>36</b> DPST, 2NC slow acting, gold contacts | <b>D</b> Top roller lever                                  |  |   |

NOTE: not all combinations of model codes are available. Please contact your Honeywell provider/representative for assistance.

\*For Type A modification codes, more than one code may be permissible. For example, GLCA01A1B-13 is a side rotary, lever-actuated switch, GLCA01A1B, adjusted for clockwise actuation only. The operating shaft is to the right side of the switch when viewing the switch from the front (label side).

# MICRO SWITCH Global Miniature Limit Switches, GLC | GLD | GLE Series

## MICRO SWITCH™ GLC SERIES ORDER GUIDE/RECOMMENDED LISTINGS

For listings not shown, contact your Honeywell representative.

**Table 3. Side Rotary, Plastic Roller**

|   | Contacts | Contact Type  | Contact Mtl | Conduit    | Oper. Torque                     | Bar Chart <sup>1</sup>  | Listing   |
|---|----------|---|-------------|------------|----------------------------------|---|-----------|
|  | 1NC/1NO  | <br>Snap action      | Silver      | 0.5-14 NPT | 0,12 Nm max.<br>[1.1 in-lb max.] |  | GLCA01A1A |
|   |          |   | Silver      | PG 13,5    |                                  |   | GLCB01A1A |
|   |          |   | Silver      | 20 mm      |                                  |   | GLCC01A1A |
|   |          |   | Gold plated | 20 mm      |                                  |   | GLCC07A1A |
|   | 1NC/1NO  | <br>BBM, slow action | Silver      | 0.5-14 NPT | 0,11 Nm max.<br>[1.0 in-lb max.] |  | GLCA03A1A |
|   | 2 NO     | <br>Slow action      | Silver      | 0.5-14 NPT | 0,11 Nm max.<br>[1.0 in-lb max.] |  | GLCA05A1A |

<sup>1</sup>Contact closed ■; Contact open □. \*Positive opening occurs.

**Table 4. Side Rotary, Metal Roller**

|   | Contacts | Contact Type  | Contact Mtl | Conduit    | Oper. Torque                     | Bar Chart <sup>1</sup>  | Listing   |
|---|----------|---|-------------|------------|----------------------------------|---|-----------|
|  | 1NC/1NO  | <br>Snap action       | Silver      | 0.5-14 NPT | 0,12 Nm max.<br>[1.1 in-lb max.] |   | GLCA01A1B |
|   |          |   | Silver      | PG 13,5    |                                  |   | GLCB01A1B |
|   |          |   | Silver      | 20 mm      |                                  |   | GLCC01A1B |
|   |          |   | Gold plated | PG 13,5    |                                  |   | GLCB07A1B |
|   |          |   | Gold plated | 20 mm      |                                  |   | GLCC07A1B |
|   | 1NC/1NO  | <br>BBM, slow action | Silver      | 0.5-14 NPT | 0,11 Nm max.<br>[1.0 in-lb max.] |  | GLCA03A1B |
|   |          |   |             | PG 13,5    |                                  |   | GLCB03A1B |
|   | 1NC/1NO  | <br>MBB, slow action | Silver      | 0.5-14 NPT | 0,11 Nm max.<br>[1.0 in-lb max.] |  | GLCA04A1B |
|   |          |   |             | PG 13,5    |                                  |   | GLCB04A1B |
|   | 2 NC     | <br>Slow action      | Silver      | PG 13,5    | 0,11 Nm max.<br>[1.0 in-lb max.] |  | GLCB06A1B |

<sup>1</sup>Contact closed ■; Contact open □. \*Positive opening occurs.

**Table 5. Side Rotary Adjustable, Plastic Roller**

|   | Contacts | Contact Type   | Contact Mtl      | Conduit   | Oper. Torque                     | Bar Chart <sup>1</sup>  | Listing                          |
|---|----------|--|------------------|---|----------------------------------|---|----------------------------------|
|  | 1NC/1NO  | <br>Snap action | Silver           | 0.5-14 NPT  | 0,12 Nm max.<br>[1.1 in-lb max.] |  | GLCA01A2A                        |
|   |          |  | Silver           | PG 13,5   |                                  |   | GLCB01A2A                        |
|   |          |  | BBM, slow action | <br>BBM, slow action | Silver                           | PG 13,5   | 0,11 Nm max.<br>[1.0 in-lb max.] |

<sup>1</sup>Contact closed ■; Contact open □. \*Positive opening occurs.

# MICRO SWITCH Global Miniature Limit Switches, GLC | GLD | GLE Series

Table 6. Side Rotary Adjustable, Metal Roller

|   | Contacts  | Contact Type   | Contact Mtl | Conduit                          | Oper. Torque  | Bar Chart <sup>1</sup>  | Listing   |
|---|---|--|-------------|----------------------------------|---|---|-----------|
|  | 1NC/1NO   | Snap action<br> | Silver      | 0.5-14 NPT                       | 0,12 Nm max.<br>[1.1 in-lb max.]  |  | GLCA01A2B |
|   |   |  | Silver      | PG 13,5                          |   |   | GLCB01A2B |
|   |   |  | Gold plated | PG 13,5                          |   |   | GLCB07A2B |
|   |   |  | Silver      | 20 mm                            |   |   | GLCC01A2B |
|   |   |  | Gold plated | 20 mm                            |   |   | GLCC07A2B |
| 1NC/1NO   | MBB, slow action<br> | Silver   | 0.5-14 NPT  | 0,11 Nm max.<br>[1.0 in-lb max.] |  | GLCA04A2B   |           |
| 1NC/1NO   | BBM, slow action<br> | Silver   | 20 mm       | 0,11 Nm max.<br>[1.0 in-lb max.] |  | GLCC03A2B   |           |
| 2NC   | Slow action<br>      | Silver   | PG 13,5     | 0,11 Nm max.<br>[1.0 in-lb max.] |  | GLCB06A2B   |           |

<sup>1</sup>Contact closed ■; Contact open □; \*Positive opening occurs.

Table 7. Side Rotary Adjustable, Metal Rod, A4J (140 mm rod) and A4L (200 mm rod)

|   | Contacts | Contact Type   | Contact Mtl | Conduit    | Oper. Torque                     | Bar Chart <sup>1</sup>  | Listing   |
|---|----------|--|-------------|------------|----------------------------------|---|-----------|
|  | 1NC/1NO  | Snap action<br> | Silver      | 0.5-14 NPT | 0,12 Nm max.<br>[1.1 in-lb max.] |  | GLCA01A4J |
|   |          |  |             | PG 13,5    |                                  |   | GLCB01A4J |
|   |          |  |             | 20 mm      |                                  |   | GLCC01A4J |
|   |          |  |             | PG13,5     |                                  |   | GLCB01A4L |

<sup>1</sup>Contact closed ■; Contact open □; \*Positive opening occurs.

Table 8. Side Rotary Offset Lever, Metal Roller

|   | Contacts | Contact Type   | Contact Mtl | Conduit    | Oper. Torque                     | Bar Chart <sup>1</sup>  | Listing   |
|---|----------|--|-------------|------------|----------------------------------|---|-----------|
|  | 1NC/1NO  | Snap action<br> | Silver      | 0.5-14NPT  | 0,12 Nm max.<br>[1.1 in-lb max.] |  | GLCA01A5B |
|   |          |  | Silver      | PG 13,5    |                                  |   | GLCB01A5B |
|   | 2NC      | Slow action<br> | Silver      | 0.5-14 NPT | 0,11 Nm max.<br>[1.0 in-lb max.] |  | GLCA06A5B |
|   |          |  | Gold plated | 0.5-14 NPT |                                  |   | GLCA36A5B |

# MICRO SWITCH Global Miniature Limit Switches, GLC | GLD | GLE Series

<sup>1</sup>Contact closed ■; Contact open □. \*Positive opening occurs.

**Table 9. Side Rotary Conveyor Lever, Ceramic Roller**

|   | Contacts | Contact Type   | Contact Mtl | Conduit    | Oper. Torque                     | Bar Chart <sup>1</sup>  | Listing   |
|---|----------|--|-------------|------------|----------------------------------|---|-----------|
|  | 1NC/1NO  | Snap action<br> | Silver      | 0.5-14 NPT | 0,12 Nm max.<br>[1.1 in-lb max.] |  | GLCA01A9A |
|   |          |  |             | PG 13,5    |                                  |   | GLCB01A9A |
|   |          |  |             | 20 mm      |                                  |   | GLCC01A9A |

<sup>1</sup>Contact closed ■; Contact open □. \*Positive opening occurs.

**Table 10. Top Pin Plunger**

|  | Contacts  | Contact Type   | Contact Mtl | Conduit                    | Oper. Force   | Bar Chart <sup>1</sup>  | Listing |
|--|---|--|-------------|----------------------------|---|---|---------|
|  | 1NC/1NO   | Snap action<br> | Silver      | 0.5-14 NPT                 | 16 N max.<br>[3.6 lb max.]  |  | GLCA01B |
|  |   |  | Silver      | PG 13,5                    |   |   | GLCB01B |
|  |   |  | Silver      | 20 mm                      |   |   | GLCC01B |
|  |   |  | Gold plated | PG 13,5                    |   |   | GLCB07B |
| 1NC/1NO  | BBM, slow action<br>  | Silver   | 0.5-14 NPT  | 14 N max.<br>[3.2 lb max.] |   | GLCA03B   |         |
|  |   |  | PG 13,5     |                            |   | GLCB03B   |         |
| 1NC/1NO  | MBB, slow action<br> | Silver   | 0.5-14 NPT  | 16 N max.<br>[3.6 lb max.] |  | GLCA04B   |         |
|  |   |  | PG 13,5     |                            |   | GLCB04B   |         |
| 2 NC   | Slow action<br>      | Silver   | PG 13,5     | 13 N max.<br>[2.9 lb max.] |  | GLCB06B   |         |

<sup>1</sup>Contact closed ■; Contact open □. \*Positive opening occurs. NOTE: Bar chart measurements are in millimeters.

**Table 11. Top Roller Plunger**

|   | Contacts  | Contact Type   | Contact Mtl | Conduit                    | Oper. Force   | Bar Chart <sup>1</sup>  | Listing |
|---|---|--|-------------|----------------------------|---|---|---------|
|  | 1NC/1NO   | Snap action<br> | Silver      | 0.5-14 NPT                 | 16 N max.<br>[3.6 lb max.]  |  | GLCA01C |
|   |   |  | Silver      | PG 13,5                    |   |   | GLCB01C |
|   |   |  | Gold plated | PG 13,5                    |   |   | GLCB07C |
|   |   |  | Silver      | 20 mm                      |   |   | GLCC01C |
| 1NC/1NO   | BBM, slow action<br> | Silver   | 0.5-14 NPT  | 14 N max.<br>[3.2 lb max.] |  | GLCA03C   |         |
|   |   |  | PG 13,5     |                            |   | GLCB03C   |         |
| 1NC/1NO   | MBB, slow action<br> | Silver   | PG 13,5     | 16 N max.<br>[3.6 lb max.] |  | GLCB04C   |         |
| 2NC   | Slow action<br>      | Silver   | PG 13,5     | 13 N max.<br>[2.9 lb max.] |  | GLCB06C   |         |
|   |   | Gold plated  | PG 13,5     |                            |   | GLCB36C   |         |
|   |   | Silver   | 20 mm       |                            |   | GLCC06C   |         |

# MICRO SWITCH Global Miniature Limit Switches, GLC | GLD | GLE Series

<sup>1</sup>Contact closed ■; Contact open □. \*Positive opening occurs. NOTE: Bar chart measurements are in millimeters.

**Table 12. Top Roller Lever**

|   | Contacts  | Contact Type   | Contact Mtl | Conduit                    | Oper. Force   | Bar Chart <sup>1</sup>  | Listing |
|---|---|--|-------------|----------------------------|---|---|---------|
|  | 1NC/1NO   | Snap action<br> | Silver      | 0.5-14 NPT                 | 10 N max.<br>[2.2 lb max.]  |  | GLCA01D |
|   |   |  | Silver      | PG 13,5                    |   |   | GLCB01D |
|   |   |  | Gold plated | PG 13,5                    |   |   | GLCB07D |
|   |   |  | Silver      | 20 mm                      |   |   | GLCC01D |
| 1NC/1NO   | BBM, slow action<br> | Silver   | 0.5-14 NPT  | 9 N max.<br>[2.0 lb max.]  |  | GLCA03D   |         |
|   |   | Silver   | PG 13,5     |                            |   | GLCB03D   |         |
|   |   | Gold plated  | PG 13,5     |                            |   | GLCB33D   |         |
| 1NC/1NO   | MBB, slow action<br> | Silver   | PG 13,5     | 10 N max.<br>[2.2 lb max.] |  | GLCB04D   |         |
| 2NC   | Slow action<br>      | Silver   | 20 mm       | 8 N max.<br>[1.8 lb max.]  |  | GLCC06D   |         |
|   |   | Gold plated  | 0.5-14 NPT  |                            |   | GLCA36D   |         |

<sup>1</sup>Contact closed ■; Contact open □. \*Positive opening occurs. NOTE: Bar chart measurements are in millimeters.

**Table 13. Coil Spring Wobble, 130 mm**

|   | Contacts  | Contact Type   | Contact Mtl | Conduit                      | Oper. Force   | Bar Chart <sup>1</sup>  | Listing   |
|---|---|--|-------------|------------------------------|---|---|-----------|
|  | 1NC/1NO   | Snap action<br> | Silver      | 0.5-14 NPT                   | 1,3 N max.<br>[0.29 lb] max.  |  | GLCA01E7B |
|   |   |  | Silver      | PG 13,5                      |   |   | GLCB01E7B |
|   |   |  | Silver      | 20 mm                        |   |   | GLCC01E7B |
|   |   |  | Gold plated | PG 13,5                      |   |   | GLCB07E7B |
| 1NC/1NO   | BBM, slow action<br> | Silver   | 0.5-14 NPT  | 1,1 N max.<br>[0.25 lb] max. |  | GLCA03E7B   |           |
| 2NC   | Slow action<br>      | Silver   | 0.5-14 NPT  | 1,1 N max.<br>[0.25 lb] max. |  | GLCA06E7B   |           |

<sup>1</sup>Contact closed ■; Contact open □.

**Table 14. Cat Whisker Wobble, 140 mm**

|   | Contacts | Contact Type   | Contact Mtl | Conduit    | Oper. Force                  | Bar Chart <sup>1</sup>  | Listing   |
|---|----------|--|-------------|------------|------------------------------|---|-----------|
|  | 1NC/1NO  | Snap action<br> | Silver      | 0.5-14 NPT | 0,9 N max.<br>[0.19 lb] max. |  | GLCA01K8A |
|   |          |  |             | PG 13,5    |                              |   | GLCB01K8A |

<sup>1</sup>Contact closed ■; Contact open □.

# MICRO SWITCH Global Miniature Limit Switches, GLC | GLD | GLE Series

Table 15. Cat Whisker Wobble, 190 mm

|   | Contacts | Contact Type  | Contact Mtl | Conduit    | Oper. Force                  | Bar Chart <sup>1</sup>  | Listing          |
|---|----------|---|-------------|------------|------------------------------|---|------------------|
|  | 1NC/1NO  | Snap action<br>      | Silver      | 0.5-14 NPT | 0,9 N max.<br>[0.19 lb] max. |  | <b>GLCA01K8B</b> |
|   |          |   |             | PG 13,5    |                              |  |                  |
|   | 1NC/1NO  | BBM, slow action<br> | Silver      | 0.5-14 NPT | 0,7 N max.<br>[0.16 lb] max. |  | <b>GLCA03K8B</b> |

<sup>1</sup>Contact closed ■ Contact open □

Figure 1. GLC Side Rotary • A1, A1A, A1B, and A1Y



Figure 2. GLC Side Rotary • A2, A2A, A2B, and A2Y



Figure 4. GLC Side Rotary • A5A and A5B

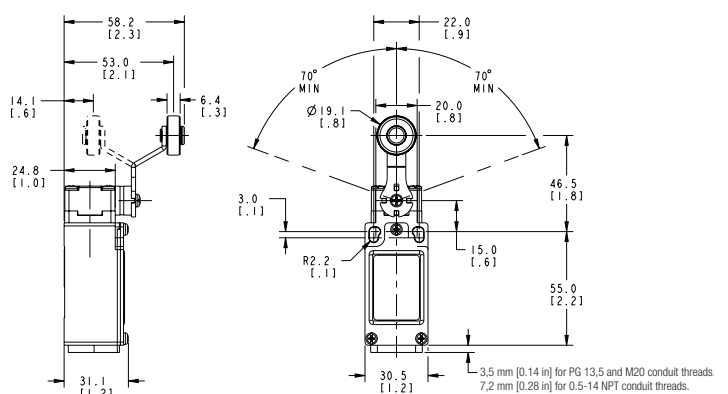

Figure 5. GLC Side Rotary • A9A

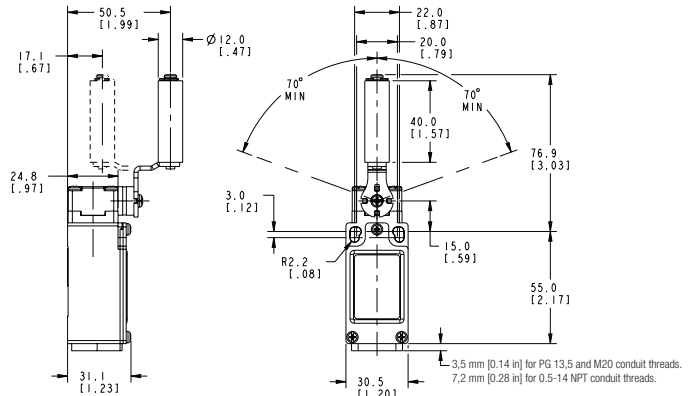
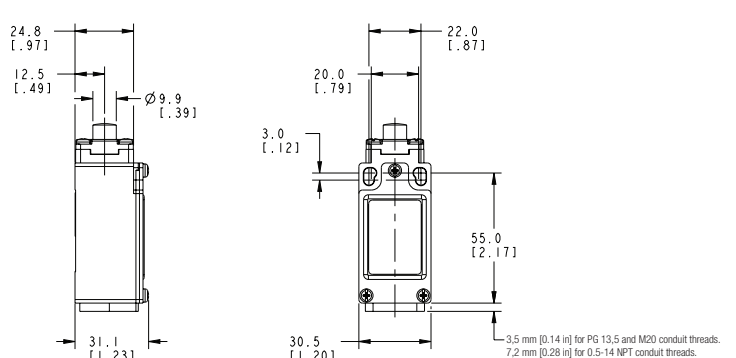
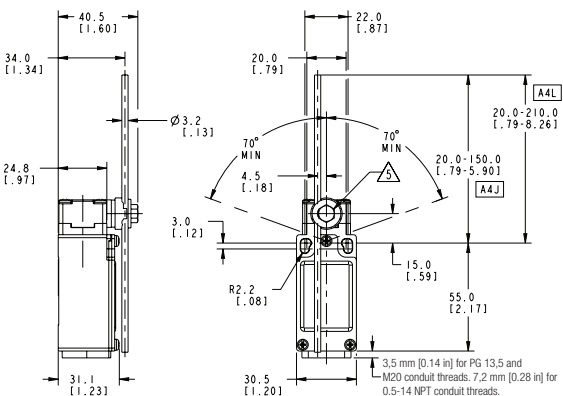

Figure 3. GLC Side Rotary Rod • A4J (140 mm) & A4L (200 mm) Figure 6. GLC Top Pin Plunger





# MICRO SWITCH Global Miniature Limit Switches, GLC | GLD | GLE Series

**Figure 7. GLC Top Roller Plunger**



**Figure 9. GLC Wobble • E7B**



**Figure 8. GLC Top Roller Arm**



**Figure 10. GLC Wobble • K8A/K8B**



**Figure 11. GLC Conduit**



# MICRO SWITCH Global Miniature Limit Switches, GLC | GLD | GLE Series

## MICRO SWITCH™ GLD SERIES ORDER GUIDE/RECOMMENDED LISTINGS

For listings not shown, contact your Honeywell representative.

Table 16. Side Rotary, Plastic Roller

|   | Contacts  | Contact Type  | Contact Mtl | Conduit                          | Oper. Torque   | Bar Chart <sup>1</sup>  | Listing                |
|---|---|---|-------------|----------------------------------|--|---|------------------------|
|  | 1NC/1NO   | Snap action<br>      | Silver      | 0.5-14 NPT                       | 0,12 Nm max.<br>[1.1 in-lb max.]   |  | GLDA01A1A              |
|   |   |   | Silver      | PG 13,5                          |  |   | GLDB01A1A              |
|   |   |   | Gold plated | PG 13,5                          |  |   | GLDB07A1A              |
|   |   |   | Silver      | 20 mm                            |  |   | GLDC01A1A              |
|   | 1NC/1NO   | BBM, slow action<br> | Silver      | 0.5-14 NPT<br>PG 13,5            | 0,11 Nm max.<br>[1.0 in-lb max.]   |  | GLDA03A1A<br>GLDB03A1A |
| 1NC/1NO   | MBB, slow action<br> | Silver  | PG 13,5     | 0,11 Nm max.<br>[1.0 in-lb max.] |   | GLDB04A1A   |                        |
| 2NO   | Slow action<br>      | Silver  | 20 mm       | 0,11 Nm max.<br>[1.0 in-lb max.] |   | GLDC05A1A   |                        |
| 2NC   | Slow action<br>     | Silver  | 20 mm       | 0,11 Nm max.<br>[1.0 in-lb max.] |  | GLDC06A1A   |                        |

<sup>1</sup>Contact closed ■, Contact open □. \*Positive opening occurs.

Table 17. Side Rotary, Metal Roller

|   | Contacts  | Contact Type   | Contact Mtl                    | Conduit                          | Oper. Torque  | Bar Chart <sup>1</sup>  | Listing   |
|---|---|--|--------------------------------|----------------------------------|---|---|-----------|
|  | 1NC/1NO   | Snap action<br> | Silver                         | 0.5-14 NPT                       | 0,12 Nm max.<br>[1.1 in-lb max.]  |  | GLDA01A1B |
|   |   |  | Silver                         | PG 13,5                          |   |   | GLDB01A1B |
|   |   |  | Gold plated                    | PG 13,5                          |   |   | GLDB07A1B |
|   |   |  | Silver                         | 20 mm                            |   |   | GLDC01A1B |
|   |   |  | Gold plated                    | 20 mm                            |   |   | GLDC07A1B |
| 1NC/1NO   | BBM, slow action<br> | Silver   | 0.5-14 NPT<br>PG 13,5          | 0,11 Nm max.<br>[1.0 in-lb max.] |  | GLDA03A1B<br>GLDB03A1B  |           |
| 2NC   | Slow action<br>      | Silver   | 0.5-14 NPT<br>PG 13,5<br>20 mm | 0,11 Nm max.<br>[1.0 in-lb max.] |  | GLDA06A1B<br>GLDB06A1B<br>GLDC06A1B   |           |

<sup>1</sup>Contact closed ■, Contact open □. \*Positive opening occurs.

# MICRO SWITCH Global Miniature Limit Switches, GLC | GLD | GLE Series

Table 18. Side Rotary Adjustable, Plastic Roller

|   | Contacts | Contact Type  | Contact Mtl | Conduit    | Oper. Torque                     | Bar Chart <sup>1</sup>  | Listing    |
|---|----------|---|-------------|------------|----------------------------------|---|------------|
|  | 1NC/1NO  | Snap action<br>      | Silver      | 0.5-14 NPT | 0,12 Nm max.<br>[1.1 in-lb max.] |  | GLDA01A2A  |
|   |          |   |             | PG 13,5    |                                  |   | GLDB01A2** |
|   |          |   | PG 13,5     | GLDB01A2A  |                                  |   |            |
|   |          |   | 20 mm       | GLDC01A2A  |                                  |   |            |
|   |          |   | Gold plated | PG 13,5    |                                  |   | GLDB07A2A  |
|   | 1NC/1NO  | BBM, slow action<br> | Silver      | PG 13,5    | 0,11 Nm max.<br>[1.0 in-lb max.] |  | GLDB03A2A  |
|   | 2NO      | Slow action<br>      | Silver      | 20 mm      | 0,11 Nm max.<br>[1.0 in-lb max.] |  | GLDC05A2A  |
|   | 2NC      | Slow action<br>      | Silver      | 0.5-14 NPT | 0,11 Nm max.<br>[1.0 in-lb max.] |  | GLDA06A2A  |
|   |          |   | Silver      | PG 13,5    |                                  |   | GLDB06A2A  |

<sup>1</sup>Contact closed ■; Contact open □. \*Positive opening occurs. \*\*No roller

Table 19. Side Rotary Adjustable, Metal Roller

|   | Contacts | Contact Type  | Contact Mtl | Conduit    | Oper. Torque                     | Bar Chart <sup>1</sup>  | Listing   |
|---|----------|---|-------------|------------|----------------------------------|---|-----------|
|  | 1NC/1NO  | Snap action<br>      | Silver      | 0.5-14 NPT | 0,12 Nm max.<br>[1.1 in-lb max.] |  | GLDA01A2B |
|   |          |   | Gold plated | 0.5-14 NPT |                                  |   | GLDA07A2B |
|   |          |   | Silver      | PG 13,5    |                                  |   | GLDB01A2B |
|   |          |   | Gold plated | PG 13,5    |                                  |   | GLDB07A2B |
|   |          |   | Silver      | 20 mm      |                                  |   | GLDC01A2B |
|   | 1NC/1NO  | MBB, slow action<br> | Silver      | 0.5-14 NPT | 0,11 Nm max.<br>[1.0 in-lb max.] |  | GLDA04A2B |
|   | 2NO      | Slow action<br>      | Silver      | 0.5-14 NPT | 0,11 Nm max.<br>[1.0 in-lb max.] |  | GLDA05A2B |

<sup>1</sup>Contact closed ■; Contact open □. \*Positive opening occurs.

# MICRO SWITCH Global Miniature Limit Switches, GLC | GLD | GLE Series

Table 20. Side Rotary Adjustable, Metal Rod

|   | Contacts | Contact Type  | Contact Mtl | Conduit    | Oper. Torque                     | Bar Chart <sup>1</sup>  | Listing   |
|---|----------|---|-------------|------------|----------------------------------|---|-----------|
|  | 1NC/1NO  |  | Silver      | 0.5-14 NPT | 0,12 Nm max.<br>[1.1 in-lb max.] |  | GLDA01A4J |
|   |          |   |             | PG 13,5    |                                  |   | GLDB01A4J |
|   |          |   |             | 20 mm      |                                  |   | GLDC01A4J |
|   | 1NC/1NO  | BBM, slow action  | Silver      | 20 mm      | 0,11 Nm max.<br>[1.0 in-lb max.] |  | GLDC03A4J |
|   | 1NC/1NO  | MBB, slow action  | Silver      | 0.5-14 NPT | 0,11 Nm max.<br>[1.0 in-lb max.] |  | GLDA04A4J |

<sup>1</sup>Contact closed ■; Contact open □. \*Positive opening occurs.

Table 21. Side Rotary Offset Lever, Metal Roller

|  | Contacts | Contact Type   | Contact Mtl | Conduit   | Oper. Torque                     | Bar Chart <sup>1</sup>  | Listing   |
|--|----------|--|-------------|-----------|----------------------------------|---|-----------|
|  | 1NC/1NO  |  | Silver      | 0.5-14NPT | 0,12 Nm max.<br>[1.1 in-lb max.] |   | GLDA01A5B |
|  |          |  | Silver      | PG 13,5   |                                  |   | GLDB01A5B |
|  |          |  | Silver      | 20 mm     |                                  |   | GLDC01A5B |
|  | 2NC      | Slow action  | Gold plated | PG 13,5   | 0,11 Nm max.<br>[1.0 in-lb max.] |  | GLDB36A5B |

<sup>1</sup>Contact closed ■; Contact open □. \*Positive opening occurs.

Table 22. Side Rotary Conveyor Lever, Ceramic Roller

|   | Contacts | Contact Type  | Contact Mtl | Conduit    | Oper. Torque                     | Bar Chart <sup>1</sup>  | Listing   |
|---|----------|---|-------------|------------|----------------------------------|---|-----------|
|  | 1NC/1NO  |  | Silver      | 0.5-14 NPT | 0,12 Nm max.<br>[1.1 in-lb max.] |  | GLDA01A9A |
|   |          |   | Gold plated | 0.5-14 NPT |                                  |   | GLDA07A9A |
|   |          |   | Silver      | 20 mm      |                                  |   | GLDC01A9A |
|   | 1NC/1NO  | BBM, slow action  | Silver      | 0.5-14 NPT | 0,11 Nm max.<br>[1.0 in-lb max.] |  | GLDA03A9A |
|   | 2NC      | Slow action   | Silver      | 0.5-14 NPT | 0,11 Nm max.<br>[1.0 in-lb max.] |  | GLDA06A9A |

<sup>1</sup>Contact closed ■; Contact open □. \*Positive opening occurs.

# MICRO SWITCH Global Miniature Limit Switches, GLC | GLD | GLE Series

**Table 23. Side Rotary, 50 mm Rubber Roller**

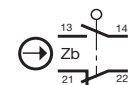
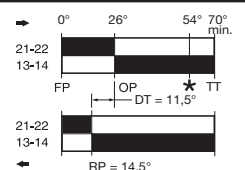
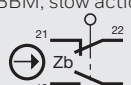
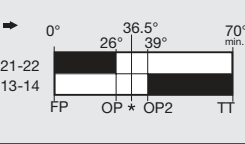
|   | Contacts | Contact Type  | Contact Mtl | Conduit    | Oper. Torque                     | Bar Chart <sup>1</sup>  | Listing   |
|---|----------|---|-------------|------------|----------------------------------|---|-----------|
|  | 1NC/1NO  | Snap action<br>      | Silver      | 0.5-14 NPT | 0,12 Nm max.<br>[1.1 in-lb max.] |  | GLDA01A1Y |
|   |          |   |             | PG 13,5    |                                  |   | GLDB01A1Y |
|   |          |   |             | 20 mm      |                                  |   | GLDC01A1Y |
|   | 1NC/1NO  | BBM, slow action<br> | Silver      | 0.5-14 NPT | 0,11 Nm max.<br>[1.0 in-lb max.] |  | GLDA03A1Y |
|   |          |   |             | PG 13,5    |                                  |   | GLDB03A1Y |

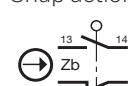
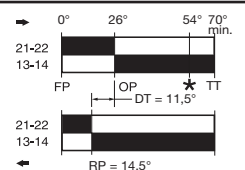
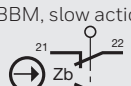
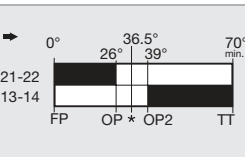

<sup>1</sup>Contact closed ■; Contact open □. \*Positive opening occurs.

**Table 24. Side Rotary Adjustable, 50 mm Rubber Roller**

|  | Contacts | Contact Type  | Contact Mtl | Conduit    | Oper. Torque                     | Bar Chart <sup>1</sup>   | Listing   |
|--|----------|---|-------------|------------|----------------------------------|--|-----------|
|  | 1NC/1NO  | Snap action<br>        | Silver      | 0.5-14 NPT | 0,12 Nm max.<br>[1.1 in-lb max.] |   | GLDA01A2Y |
|  |          |   |             | PG 13,5    |                                  |  | GLDB01A2Y |
|  |          |   |             | 20 mm      |                                  |  | GLDC01A2Y |
|  | 1NC/1NO  | BBM, slow action<br> | Silver      | 0.5-14 NPT | 0,11 Nm max.<br>[1.0 in-lb max.] |  | GLDA03A2Y |
|  |          |   |             | PG 13,5    |                                  |  | GLDB03A2Y |

<sup>1</sup>Contact closed ■; Contact open □. \*Positive opening occurs.

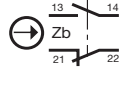
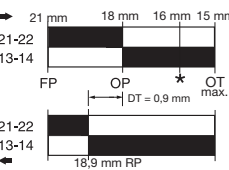
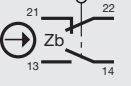
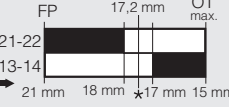
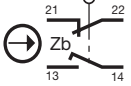
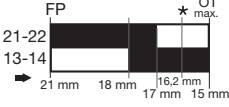
**Table 25. Top Pin Plunger**

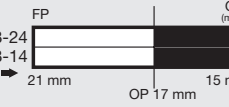
|   | Contacts | Contact Type  | Contact Mtl  | Conduit    | Oper. Torque               | Bar Chart <sup>1</sup>  | Listing   |
|---|----------|---|--|------------|----------------------------|---|---|
|  | 1NC/1NO  | Snap action<br>      | Silver   | 0.5-14 NPT | 16 N max.<br>[3.6 lb max.] |  | GLDA01B   |
|   |          |   | Silver   | PG 13,5    |                            |   | GLDB01B   |
|   |          |   | Gold plated  | PG 13,5    |                            |   | GLDB07B   |
|   |          |   | Silver   | 20 mm      |                            |   | GLDC01B   |
|   |          |   | Gold plated  | 20 mm      |                            |   | GLDC07B   |
|   | 1NC/1NO  | BBM, slow action<br> | Silver   | 0.5-14NPT  | 14 N max.<br>[3.2 lb max.] |  | GLDA03B   |
|   |          |   |  | PG 13,5    |                            |   | GLDB03B   |
|   | 1NC/1NO  | MBB, slow action<br> | Silver   | 0.5-14 NPT | 16 N max.<br>[3.6 lb max.] |  | GLDA04B   |
|   |          |   |  | PG 13,5    |                            |   | GLDB04B   |
|   |          | 2 NO  | Slow action<br> | Silver     | 20 mm                      | 13 N max.<br>[2.9 lb max.]  |  |

# MICRO SWITCH Global Miniature Limit Switches, GLC | GLD | GLE Series

<sup>1</sup>Contact closed ■, Contact open □. \*Positive opening occurs. NOTE: Bar chart measurements are in millimeters.

**Table 26. Top Roller Plunger**

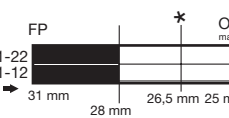
|   | Contacts  | Contact Type   | Contact Mtl | Conduit                    | Oper. Force  | Bar Chart <sup>1</sup>  | Listing |
|---|---|--|-------------|----------------------------|--|---|---------|
|  | 1NC/1NO   | Snap action<br> | Silver      | 0.5-14 NPT                 | 16 N max.<br>[3.6 lb max.]   |  | GLDA01C |
|   |   |  | Gold plated | 0.5-14 NPT                 |  |   | GLDA07C |
|   |   |  | Silver      | PG 13,5                    |  |   | GLDB01C |
|   |   |  | Gold plated | PG 13,5                    |  |   | GLDB07C |
|   |   |  | Silver      | 20 mm                      |  |   | GLDC01C |
| 1NC/1NO   | BBM, slow action<br> | Silver   | 0.5-14 NPT  | 14 N max.<br>[3.2 lb max.] |   | GLDA03C   |         |
|   |   | Silver   | PG 13,5     |                            |  | GLDB03C   |         |
|   |   | Gold plated  | PG 13,5     |                            |  | GLDB33C   |         |
|   |   | Silver   | 20 mm       |                            |  | GLDC03C   |         |
| 1NC/1NO   | MBB, slow action<br> | Silver   | PG 13,5     | 16 N max.<br>[3.6 lb max.] |   | GLDB04C   |         |
| 2NO   | Slow action<br>      | Silver   | 20 mm       | 13 N max.<br>[2.9 lb max.] |   | GLDC05C   |         |
| 2NC   | Slow action<br>     | Silver   | 0.5-14 NPT  | 13 N max.<br>[2.9 lb max.] |  | GLDA06C   |         |
|   |   | Silver   | PG 13,5     |                            |  | GLDB06C   |         |
|   |   | Gold plated  | PG 13,5     |                            |  | GLDB36C   |         |
|   |   | Silver   | 20 mm       |                            |  | GLDC06C   |         |

<sup>1</sup>Contact closed ■, Contact open □. \*Positive opening occurs. NOTE: Bar chart measurements are in millimeters.



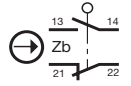
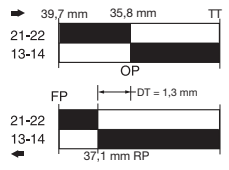
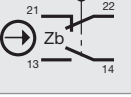
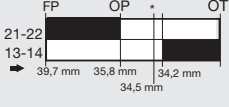
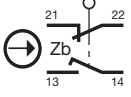
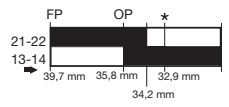
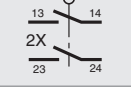
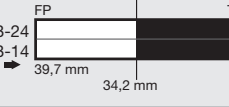
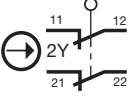
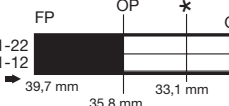
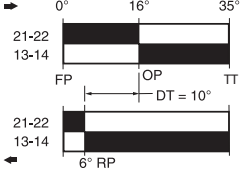

**Table 27. Top Roller Lever**

|         | Contacts  | Contact Type | Contact Mtl | Conduit                    | Oper. Force   | Bar Chart <sup>1</sup> | Listing |
|---------|---|--------------|-------------|----------------------------|---|------------------------|---------|
| 1NC/1NO | Snap action<br>      | Silver       | 0.5-14 NPT  | 10 N max.<br>[2.2 lb max.] |  | GLDA01D                |         |
|         |   |              | PG 13,5     |                            |   | GLDB01D                |         |
|         |   |              | 20 mm       |                            |   | GLDC01D                |         |
| 1NC/1NO | BBM, slow action<br> | Silver       | 0.5-14 NPT  | 9 N max.<br>[2.0 lb max.]  |  | GLDA03D                |         |
|         |   |              | PG 13,5     |                            |   | GLDB03D                |         |
|         |   |              | 20 mm       |                            |   | GLDC03D                |         |
| 1NC/1NO | MBB, slow action<br> | Silver       | PG 13,5     | 10 N max.<br>[2.2 lb max.] |  | GLDB04D                |         |
| 2NO     | Slow action<br>      | Silver       | 20 mm       | 8 N max.<br>[1.8 lb max.]  |  | GLDC05D                |         |
| 2NC     | Slow action<br>      | Silver       | 0.5-14 NPT  | 8 N max.<br>[1.8 lb max.]  |  | GLDA06D                |         |
|         |   |              | 20 mm       |                            |   | GLDC06D                |         |

<sup>1</sup>Contact closed ■, Contact open □. \*Positive opening occurs. NOTE: Bar chart measurements are in millimeters.



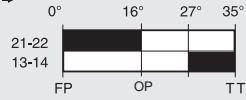

# MICRO SWITCH Global Miniature Limit Switches, GLC | GLD | GLE Series

Table 28. Coil Spring Wobble, 130 mm

|   | Contacts | Contact Type  | Contact Mtl | Conduit    | Oper. Force                  | Bar Chart <sup>1</sup>  | Listing   |
|---|----------|---|-------------|------------|------------------------------|---|-----------|
|  | 1NC/1NO  | Snap action<br>      | Silver      | 0.5-14 NPT | 1,3 N max.<br>[0.29 lb max.] |  | GLDA01E7B |
|   |          |   |             | PG 13,5    |                              |   | GLDB01E7B |
|   |          |   |             | 20 mm      |                              |   | GLDC01E7B |
|   | 1NC/1NO  | BBM, slow action<br> | Silver      | 0.5-14 NPT | 1,1 N max.<br>[0.25 lb max.] |  | GLDA03E7B |

<sup>1</sup>Contact closed ■; Contact open □.

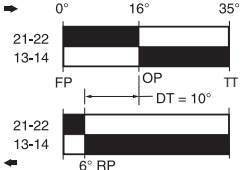
Table 29. Cat Whisker Wobble, 190 mm

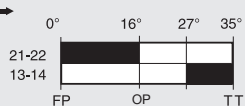
|  | Contacts | Contact Type   | Contact Mtl | Conduit    | Oper. Force                  | Bar Chart <sup>1</sup>   | Listing   |
|--|----------|--|-------------|------------|------------------------------|--|-----------|
|  | 1NC/1NO  | Snap action<br>       | Silver      | 0.5-14 NPT | 0,9 N max.<br>[0.19 lb max.] |   | GLDA01K8B |
|  |          |  |             | PG 13,5    |                              |  | GLDB01K8B |
|  |          |  |             | 20 mm      |                              |  | GLDC01K8B |
|  | 1NC/1NO  | BBM, slow action<br> | Silver      | 0.5-14 NPT | 0,7 N max.<br>[0.16 lb max.] |  | GLDA03K8B |

<sup>1</sup>Contact closed ■; Contact open □.

# MICRO SWITCH Global Miniature Limit Switches, GLC | GLD | GLE Series

## MICRO SWITCH™ **GLD** DIMENSIONAL DRAWINGS mm [in]

Figure 12. GLD Side Rotary • A1, A1A, A1B, and A1Y



Figure 15. GLD Side Rotary • A5A and A5B



Figure 16. GLD Side Rotary • A9A



Figure 13. GLD Side Rotary • A2, A2A, A2B, and A2Y

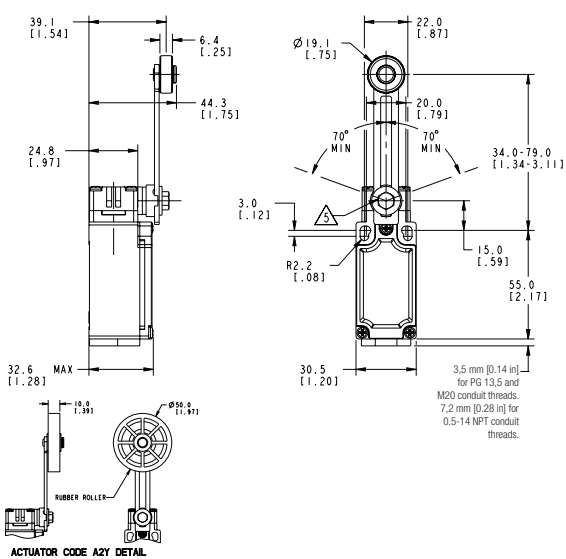

Figure 17. GLD Top Pin Plunger

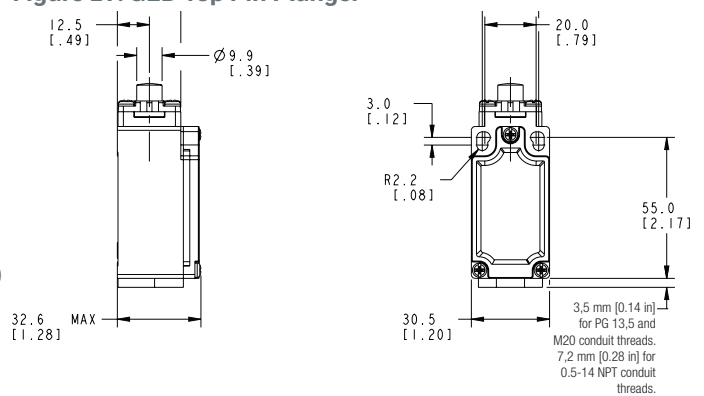

Figure 14. GLD Side Rotary Rod • A4J (140 mm) & A4L (200 mm)





# MICRO SWITCH Global Miniature Limit Switches, GLC | GLD | GLE Series

## MICRO SWITCH™ GLD DIMENSIONAL DRAWINGS mm [in]

Figure 18. GLD Top Roller Plunger



Figure 20. GLD Wobble • E7B



Figure 19. GLD Top Roller Arm



Figure 21. GLD Wobble • K8A/K8B



Figure 22. GLD Conduit



# MICRO SWITCH Global Miniature Limit Switches, GLC | GLD | GLE Series

## MICRO SWITCH™ GLE SERIES ORDER GUIDE/RECOMMENDED LISTINGS

For listings not shown, contact your Honeywell representative.

Table 30. Side Rotary, Plastic Roller

|   | Contacts | Contact Type   | Contact Mtl | Conduit †  | Oper. Torque                      | Bar Chart <sup>1</sup>  | Listing   |
|---|----------|--|-------------|------------|-----------------------------------|---|-----------|
|  | 1NC/1NO  | Snap action<br> | Silver      | 0.5-14 NPT | 0,12 Nm max.<br>[1.1 in-lb max.]  |  | GLEA01A1A |
|   |          |  |             | PG 13,5    |                                   |   | GLEB01A1A |
|   | 2NC/2NO  | Snap action<br> | Gold plated | 0.5-14 NPT | 0,165 Nm max.<br>[1.6 in-lb max.] |  | GLEA32A1A |
|   |          |  |             | PG 13,5    |                                   |   | GLEB32A1A |
|   | 2NC      | Slow action<br> | Silver      | PG 13,5    | 0,11 Nm max.<br>[1.0 in-lb max.]  |  | GLEB06A1A |
|   |          |  | Gold plated | 0.5-14 NPT |                                   |   | GLEA36A1A |

<sup>1</sup>Contact closed ■; Contact open □. \*Positive opening occurs. † 0.5-14 NPT conduit option includes adapter.

Table 31. Side Rotary, Metal Roller

|   | Contacts | Contact Type  | Contact Mtl | Conduit †  | Oper. Torque                      | Bar Chart <sup>1</sup>  | Listing   |
|---|----------|---|-------------|------------|-----------------------------------|---|-----------|
|  | 1NC/1NO  | Snap action<br>      | Silver      | 0.5-14 NPT | 0,12 Nm max.<br>[1.1 in-lb max.]  |  | GLEA01A1B |
|   |          |   | Silver      | PG 13,5    |                                   |   | GLEB01A1B |
|   |          |   | Gold plated | PG 13,5    |                                   |   | GLEB07A1B |
|   |          |   | Silver      | 20 mm      |                                   |   | GLEC01A1B |
|   | 2NC/2NO  | Snap action<br>      | Silver      | 0.5-14 NPT | 0,165 Nm max.<br>[1.6 in-lb max.] |  | GLEA24A1B |
|   |          |   | Gold plated | PG 13,5    |                                   |   | GLEB24A1B |
|   |          |   | Silver      | 20 mm      |                                   |   | GLEC24A1B |
|   | 1NC/1NO  | MBB, slow action<br> | Silver      | PG 13,5    | 0,11 Nm max.<br>[1.0 in-lb max.]  |  | GLEB04A1B |

<sup>1</sup>Contact closed ■; Contact open □. \*Positive opening occurs. † 0.5-14 NPT conduit option includes adapter.

# MICRO SWITCH Global Miniature Limit Switches, GLC | GLD | GLE Series

**Table 32. Side Rotary Adjustable, Plastic Roller**

|   | Contacts | Contact Type   | Contact Mtl | Conduit †  | Oper. Torque                      | Bar Chart <sup>1</sup>  | Listing   |
|---|----------|--|-------------|------------|-----------------------------------|---|-----------|
|  | 1NC/1NO  | Snap action<br> | Silver      | 0.5-14 NPT | 0,12 Nm max.<br>[1.1 in-lb max.]  |  | GLEA01A2A |
|   |          |  |             | PG 13,5    |                                   |   |           |
|   | 2NC/2NO  | Snap action<br> | Silver      | 0.5-14 NPT | 0,165 Nm max.<br>[1.6 in-lb max.] |  | GLEA24A2A |
|   |          |  |             | 20 mm      |                                   |   |           |

<sup>1</sup>Contact closed ■; Contact open □. \*Positive opening occurs. † 0.5-14 NPT conduit option includes adapter.

**Table 33. Side Rotary Adjustable, Metal Roller**

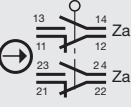
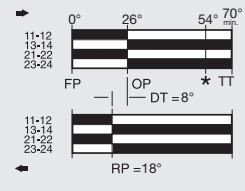
|  | Contacts   | Contact Type   | Contact Mtl | Conduit †  | Oper. Torque                      | Bar Chart <sup>1</sup>  | Listing   |
|--|--|--|-------------|------------|-----------------------------------|---|-----------|
|  | 1NC/1NO  | Snap action<br>   | Silver      | 0.5-14 NPT | 0,12 Nm max.<br>[1.1 in-lb max.]  |   | GLEA01A2B |
|  |  |  |             | PG 13,5    |                                   |   |           |
|  |  |  |             | 20 mm      |                                   |   |           |
|  | 2NC/2NO  | Snap action<br> | Silver      | PG 13,5    | 0,165 Nm max.<br>[1.6 in-lb max.] |  | GLEB01A2B |
| Gold plated  |  |  |             |            |                                   |   |           |
| 2NC/2NO  | Snap action<br> | Silver   | Silver      | 0.5-14 NPT | 0,165 Nm max.<br>[1.6 in-lb max.] |  | GLEC01A2B |
|  |  |  |             | PG 13,5    |                                   |   |           |

<sup>1</sup>Contact closed ■; Contact open □. \*Positive opening occurs. † 0.5-14 NPT conduit option includes adapter.

**Table 34. Side Rotary Adjustable, Metal Rod, A4J (140 mm Rod)**

|   | Contacts   | Contact Type   | Contact Mtl | Conduit †  | Oper. Torque                      | Bar Chart <sup>1</sup>  | Listing   |
|---|--|--|-------------|------------|-----------------------------------|---|-----------|
|  | 1NC/1NO  | Snap action<br> | Silver      | 0.5-14 NPT | 0,12 Nm max.<br>[1.1 in-lb max.]  |  | GLEA01A4J |
|   |  |  |             | PG 13,5    |                                   |   |           |
|   |  |  |             | 20 mm      |                                   |   |           |
| 2NC/2NO   | Snap action<br> | Silver   | Silver      | 0.5-14 NPT | 0,165 Nm max.<br>[1.6 in-lb max.] |  | GLEB01A4J |
|   |  |  |             |            |                                   |   | GLEC01A4J |
|   |  |  |             |            |                                   |   | GLEA24A4J |

<sup>1</sup>Contact closed ■; Contact open □. \*Positive opening occurs. † 0.5-14 NPT conduit option includes adapter.

# MICRO SWITCH Global Miniature Limit Switches, GLC | GLD | GLE Series

**Table 35. Side Rotary Offset Lever, Plastic Roller**

|   | Contacts | Contact Type   | Contact Mtl | Conduit †  | Oper. Torque                     | Bar Chart <sup>1</sup>  | Listing          |
|---|----------|--|-------------|------------|----------------------------------|---|------------------|
|  | 1NC/1NO  | Snap action<br> | Silver      | 0.5-14 NPT | 0,12 Nm max.<br>[1.1 in-lb max.] |  | <b>GLEA01A5A</b> |
|   |          |  |             | PG 13,5    |                                  |  | <b>GLEB01A5A</b> |

<sup>1</sup>Contact closed ■, Contact open □. \*Positive opening occurs. † 0.5-14 NPT conduit option includes adapter.

**Table 36. Side Rotary Offset Lever, Metal Roller**

|   | Contacts   | Contact Type  | Contact Mtl | Conduit †                        | Oper. Torque  | Bar Chart <sup>1</sup>  | Listing          |
|---|--|---|-------------|----------------------------------|---|---|------------------|
|  | 1NC/1NO  | Snap action<br>      | Silver      | 0.5-14 NPT                       | 0,12 Nm max.<br>[1.1 in-lb max.]  |  | <b>GLEA01A5B</b> |
|   |  |   |             | PG 13,5                          |   |  | <b>GLEB01A5B</b> |
|   | 1NC/1NO  | BBM, slow action<br> | Silver      | PG 13,5                          | 0,11 Nm max.<br>[1.0 in-lb max.]  |  | <b>GLEB03A5B</b> |
| 2NC/2NO   | Snap action<br> | Silver  | 0.5-14 NPT  | 0,165 Nm max.<br>[1.6 in-lb max] |  | <b>GLEA24A5B</b>  |                  |

<sup>1</sup>Contact closed ■, Contact open □. \*Positive opening occurs. † 0.5-14 NPT conduit option includes adapter.

**Table 37. Side Rotary Conveyor Lever, Ceramic Roller**

|   | Contacts | Contact Type   | Contact Mtl | Conduit † | Oper. Torque                     | Bar Chart <sup>1</sup>  | Listing          |
|---|----------|--|-------------|-----------|----------------------------------|---|------------------|
|  | 1NC/1NO  | Snap action<br> | Silver      | PG 13,5   | 0,12 Nm max.<br>[1.1 in-lb max.] |  | <b>GLEB01A9A</b> |
|   |          |  |             | 20 mm     |                                  |  | <b>GLEC01A9A</b> |

# MICRO SWITCH Global Miniature Limit Switches, GLC | GLD | GLE Series

<sup>1</sup>Contact closed ■; Contact open □. \*Positive opening occurs.

**Table 38. Top Pin Plunger**

|   | Contacts   | Contact Type  | Contact Mtl | Conduit †                  | Oper. Force   | Bar Chart <sup>1</sup>  | Listing |
|---|--|---|-------------|----------------------------|---|---|---------|
|  | 1NC/1NO  | Snap action<br>      | Silver      | 0.5-14 NPT                 | 16 N max.<br>[3.6 lb max.]  |  | GLEA01B |
|   |  |   |             | PG 13,5                    |   |   | GLEB01B |
|   |  |   | 20 mm       | GLEC01B                    |   |   |         |
|   | 1NC/1NO  | BBM, slow action<br> | Silver      | PG 13,5                    | 14 N max.<br>[3.2 lb max.]  |  | GLEB03B |
|   |  |   |             | 20 mm                      |   |   | GLEC03B |
|   |  |   | PG 13,5     | 20 mm                      |   |   | GLEB33B |
| 2NC/2NO   | Snap action<br> | Silver  | 0.5-14 NPT  | 13 N max.<br>[2.9 lb max.] |  | GLEA24B   |         |
|   |  |   | PG 13,5     |                            |   | GLEB24B   |         |
|   |  | 20 mm   | GLEC24B     |                            |   |   |         |
|   |  | Gold plated   | 20 mm       |                            |   | GLEC32B   |         |

<sup>1</sup>Contact closed ■; Contact open □. \*Positive opening occurs. NOTE: Bar chart measurements are in millimeters. † 0.5-14 NPT conduit option includes adapter.

**Table 39. Top Roller Plunger**

|   | Contacts | Contact Type   | Contact Mtl | Conduit †  | Oper. Force                | Bar Chart <sup>1</sup>  | Listing |
|---|----------|--|-------------|------------|----------------------------|---|---------|
|  | 1NC/1NO  | Snap action<br> | Silver      | 0.5-14 NPT | 16 N max.<br>[3.6 lb max.] |   | GLEA01C |
|   |          |  |             | PG 13,5    |                            |   | GLEB01C |
|   |          |  | 20 mm       | GLEC01C    |                            |   |         |
|   | 2NC/2NO  | Snap action<br> | Silver      | 0.5-14 NPT | 13 N max.<br>[2.9 lb max.] |  | GLEA24C |
| PG 13,5   |          |  |             | GLEB24C    |                            |   |         |
| 20 mm   |          |  | GLEC24C     |            |                            |   |         |

<sup>1</sup>Contact closed ■; Contact open □. \*Positive opening occurs. NOTE: Bar chart measurements are in millimeters. † 0.5-14 NPT conduit option includes adapter.

**Table 40. Top Roller Lever**

# MICRO SWITCH Global Miniature Limit Switches, GLC | GLD | GLE Series

|   | Contacts   | Contact Type   | Contact Mtl | Conduit †                 | Oper. Force   | Bar Chart <sup>1</sup>  | Listing        |                |
|---|--|--|-------------|---------------------------|---|---|----------------|----------------|
|  | 1NC/1NO  | Snap action<br> | Silver      | 0.5-14 NPT                | 10 N max.<br>[2.2 lb max.]  |  | <b>GLEA01D</b> |                |
|   |  |  |             | PG 13,5                   |   |   |                | <b>GLEB01D</b> |
|   |  |  |             | 20 mm                     |   |   |                |                |
|   | 2NC/2NO  | Snap action<br> | Silver      | 0.5-14 NPT                | 3,2 N max.<br>[0.72 lb max.]  |  | <b>GLEA24D</b> |                |
|   |  |  |             | PG 13,5                   |   |   |                | <b>GLEB24D</b> |
|   |  |  |             | 20 mm                     |   |   |                |                |
| 2 NC  | Slow action<br> | Silver   | 0.5-14 NPT  | 8 N max.<br>[1.8 lb max.] |  | <b>GLEA06D</b>  |                |                |

<sup>1</sup>Contact closed ■; Contact open □. \*Positive opening occurs. NOTE: Bar chart measurements are in millimeters. † 0.5-14 NPT conduit option includes adapter.

**Table 41. Coil Spring Wobble, 130 mm**

|  | Contacts | Contact Type  | Contact Mtl | Conduit †  | Oper. Force                  | Bar Chart <sup>1</sup>   | Listing          |                  |
|--|----------|---|-------------|------------|------------------------------|--|------------------|------------------|
|  | 1NC/1NO  | Snap action<br> | Silver      | 0.5-14 NPT | 1,3 N max.<br>[0.29 lb max.] |  | <b>GLEA01E7B</b> |                  |
|  |          |   |             | PG 13,5    |                              |  |                  | <b>GLEB01E7B</b> |
|  |          |   |             | 0.5-14 NPT |                              |  |                  |                  |
|  | PG 13,5  | <b>GLEB24E7B</b>  |             |            |                              |  |                  |                  |

<sup>1</sup>Contact closed ■; Contact open □. \*Positive opening occurs. NOTE: Bar chart measurements are in millimeters. † 0.5-14 NPT conduit option includes adapter.

**Table 42. Cat Whisker Wobble, 140 mm**

|   | Contacts | Contact Type   | Contact Mtl | Conduit †  | Oper. Force                  | Bar Chart <sup>1</sup>  | Listing          |
|---|----------|--|-------------|--|------------------------------|---|------------------|
|  | 1NC/1NO  | Snap action<br> | Silver      | PG 13,5  | 0,9 N max.<br>[0.19 lb max.] |  | <b>GLEB01K8A</b> |
|   |          |  |             | PG 13,5  |                              |   |                  |
|   |          |  | 2NC/2NO     | Snap action<br> |                              |   | Silver           |

<sup>1</sup>Contact closed ■; Contact open □.

# MICRO SWITCH Global Miniature Limit Switches, GLC | GLD | GLE Series

## MICRO SWITCH™ GLE DIMENSIONAL DRAWINGS mm [in]

Figure 23. GLE Side Rotary • A1, A1A, A1B, and A1Y



Figure 26. GLE Side Rotary • A5A and A5B



Figure 24. GLE Side Rotary • A2, A2A, A2B, and A2Y



Figure 27. GLE Side Rotary • A9A



Figure 25. GLE Side Rotary • A4J and A4L



Figure 28. GLE Top Pin Plunger



# MICRO SWITCH Global Miniature Limit Switches, GLC | GLD | GLE Series

## MICRO SWITCH™ GLE DIMENSIONAL DRAWINGS mm [in]

Figure 29. GLE Top Roller Plunger



Figure 31. GLE Wobble • E7B



Figure 30. GLE Top Roller Arm



Figure 32. GLE Wobble • K8A



Figure 33. GLE Conduit Adapter for 0.5-14 NPT





# MICRO SWITCH Global Miniature Limit Switches, GLC | GLD | GLE Series

## FACTORY PRE-WIRED LIMIT SWITCHES WITH INTEGRAL CONNECTOR

### Epoxy-coated Metal Limit Switches

**GLCC01B-D1:** Top pin plunger, 1NC/1NO snap action, with Deutsch DT style 4 pin connector

**GLCC01C-D1:** Top roller plunger, 1NC/1NO snap action, with Deutsch DT style 4 pin connector

**GLCC06A1B-D1:** Side rotary with metal roller, 2NC slow action, with Deutsch DT style 4 pin connector

### Plastic Limit Switches

**GLDC01A1A-D1:** Side rotary with plastic roller, 1NC/1NO snap action, with Deutsch DT style 4 pin connector

**GLDC01A1B-D1:** Side rotary with metal roller, 1NC/1NO snap action, with Deutsch DT style 4 pin connector

**GLDC01C-D1:** Top roller plunger, 1NC/1NO snap action, with Deutsch DT style 4 pin connector

Note: Reference base catalog listing for switch characteristics. For example, cat. listing GLCC01B-D1 has base cat. listing GLCC01B.



## FACTORY PRE-WIRED LIMIT SWITCHES WITH INTEGRAL CONNECTOR

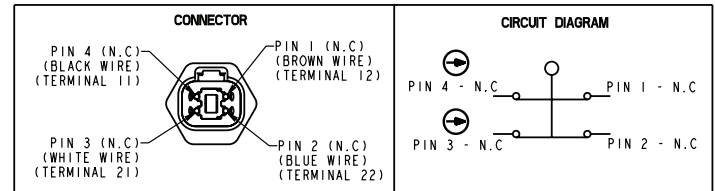
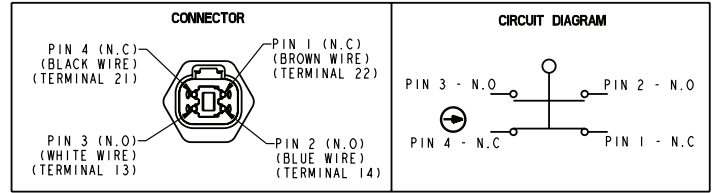

### Connector Without Limit Switch



**GLZ8C-DEU:** DT style 4 pin connector prewired with 6 in. of lead wires (4) and 20 mm conduit thread with jam nut



**GLZ8C-PA:** DT style 4 pin connector packet with all parts furnished unassembled for a 20 mm conduit thread

## REPLACEMENT PARTS - BASIC SWITCHES

| Body Type | Basic Switch |        |        |        |        |        |        |        |        |        |
|-----------|--------------|--------|--------|--------|--------|--------|--------|--------|--------|--------|
|           | 01           | 03     | 04     | 06     | 07     | 24     | 32     | 33     | 34     | 36     |
| GLC       | GLZ301       | GLZ303 | GLZ304 | GLZ306 | GLZ307 | n/a    | n/a    | GLZ333 | GLZ334 | GLZ336 |
| GLD       | GLZ301       | GLZ303 | GLZ304 | GLZ306 | GLZ307 | n/a    | n/a    | GLZ333 | GLZ334 | GLZ336 |
| GLE       | GLZ301       | GLZ303 | GLZ304 | GLZ306 | GLZ307 | GLZ324 | GLZ332 | GLZ333 | GLZ334 | GLZ336 |

## ADDITIONAL MATERIALS

The following associated literature is available on the Honeywell web site at [sensing.honeywell.com](http://sensing.honeywell.com):

- Product installation instructions
- Aerospace range guide
- Transportation range guide
- Limits and Machine Safety range guide
- Product application-specific information
  - Application Note: Sensors and Switches for Industrial Manual Process Valves
  - Application Note: Sensors and Switches Used in Valve Actuators and Valve Positioners
  - Industrial Machinery Switch Guide
  - Limit and Enclosed Switches Application Information
  - Limit and Enclosed Switches Operating Characteristics
  - Limit and Enclosed Switches Reference Standards
  - Limit and Enclosed Switches Typical Applications
  - Sensors and Switches in Mobile Cranes
  - Sensors and Switches in Front Loaders
  - Sensors and Switches in Elevator Applications

### For more information

Honeywell Sensing and Internet of Things services its customers through a worldwide network of sales offices and distributors. For application assistance, current specifications, pricing or the nearest Authorized Distributor, visit [sensing.honeywell.com](http://sensing.honeywell.com) or call:

|              |                     |
|--------------|---------------------|
| Asia Pacific | +65 6355-2828       |
| Europe       | +44 (0) 1698 481481 |
| USA/Canada   | +1-800-537-6945     |

### Honeywell Sensing and Internet of Things

9680 Old Bailes Road  
Fort Mill, SC 29707  
[www.honeywell.com](http://www.honeywell.com)

## **⚠ WARNING** **PERSONAL INJURY**

DO NOT USE these products as safety or emergency stop devices or in any other application where failure of the product could result in personal injury.

**Failure to comply with these instructions could result in death or serious injury.**

## **⚠ WARNING** **MISUSE OF DOCUMENTATION**

- The information presented in this product sheet is for reference only. Do not use this document as a product installation guide.
- Complete installation, operation, and maintenance information is provided in the instructions supplied with each product.

**Failure to comply with these instructions could result in death or serious injury.**

### Warranty/Remedy

Honeywell warrants goods of its manufacture as being free of defective materials and faulty workmanship. Honeywell's standard product warranty applies unless agreed to otherwise by Honeywell in writing; please refer to your order acknowledgement or consult your local sales office for specific warranty details. If warranted goods are returned to Honeywell during the period of coverage, Honeywell will repair or replace, at its option, without charge those items it finds defective.

**The foregoing is buyer's sole remedy and is in lieu of all other warranties, expressed or implied, including those of merchantability and fitness for a particular purpose. In no event shall Honeywell be liable for consequential, special, or indirect damages.**

While we provide application assistance personally, through our literature and the Honeywell web site, it is up to the customer to determine the suitability of the product in the application.

Specifications may change without notice. The information we supply is believed to be accurate and reliable as of this printing. However, we assume no responsibility for its use.



Компания «ЭлектроПласт» предлагает заключение долгосрочных отношений при поставках импортных электронных компонентов на взаимовыгодных условиях!

Наши преимущества:

- Оперативные поставки широкого спектра электронных компонентов отечественного и импортного производства напрямую от производителей и с крупнейших мировых складов;
- Поставка более 17-ти миллионов наименований электронных компонентов;
- Поставка сложных, дефицитных, либо снятых с производства позиций;
- Оперативные сроки поставки под заказ (от 5 рабочих дней);
- Экспресс доставка в любую точку России;
- Техническая поддержка проекта, помощь в подборе аналогов, поставка прототипов;
- Система менеджмента качества сертифицирована по Международному стандарту ISO 9001;
- Лицензия ФСБ на осуществление работ с использованием сведений, составляющих государственную тайну;
- Поставка специализированных компонентов (Xilinx, Altera, Analog Devices, Intersil, Interpoint, Microsemi, Aeroflex, Peregrine, Syfer, Eurofarad, Texas Instrument, Miteq, Cobham, E2V, MA-COM, Hittite, Mini-Circuits, General Dynamics и др.);

Помимо этого, одним из направлений компании «ЭлектроПласт» является направление «Источники питания». Мы предлагаем Вам помощь Конструкторского отдела:

- Подбор оптимального решения, техническое обоснование при выборе компонента;
- Подбор аналогов;
- Консультации по применению компонента;
- Поставка образцов и прототипов;
- Техническая поддержка проекта;
- Защита от снятия компонента с производства.



#### Как с нами связаться

**Телефон:** 8 (812) 309 58 32 (многоканальный)

**Факс:** 8 (812) 320-02-42

**Электронная почта:** [org@eplast1.ru](mailto:org@eplast1.ru)

**Адрес:** 198099, г. Санкт-Петербург, ул. Калинина, дом 2, корпус 4, литера А.