

MICRO SWITCH Global Miniature Limit Switches

GLC | GLD | GLE Series

107147

Issue 17

Datasheet



DESCRIPTION

Honeywell MICRO SWITCH GLS miniature limit switch family offers a wide range of products for global solutions. These durable and reliable limit switches are suitable for many industrial applications, agriculture equipment, transportation equipment, and other applications requiring an environmentally sealed (IP and NEMA) switch.

The compact housings are often ideal for equipment where space is at a premium. The extensive product range is available in three different housing types; metal housing, plastic housing or a three conduit metal housing which are mounting compatible to EN50047. A wide range of actuators, contact blocks, and conduit/connectivity options enhance the product offering.

In today's demanding age of logic-level controls, electromechanical switches are frequently used to interface with PLCs and other logic level devices. GLS limit switches offer an option for gold-plated contacts for the standard switch. This option promotes the switch reliability for logic-level applications.

VALUE TO CUSTOMERS

- Meets EN50047 mounting standards and EN/IEC electrical standards for world-wide use
- Large existing install base and channel allows for quick delivery worldwide
- Wide range of actuators and circuitry options in same footprint
- Certified for global use with CCC¹, CSA, CE, and UL acceptance

DIFFERENTIATION

- Modular design of limit switch (heads/actuators, bodies, and contact blocks) allows for rapid customization and delivery
- Removable contact block for wiring ease
- Galvanically isolated contacts for controlling two separate circuits

FEATURES

- Designed to EN50047 standard
- Metal housing or double-insulated plastic housing for indoor and outdoor applications
- Wide range of actuator heads and levers
- Heads can be positioned at 90° increments for design flexibility. Side rotary actuator heads can be factory set for CW, CCW, or CW and CCW actuation
- Certified for global applications: CE, UL, CSA, CCC¹
- Conforms to CE, EN50047, IEC/EN 60947-5-1; CSA C22.2 #14; UL 508; CCC¹ GB14048.5, EN45545-2 (GLC/GLE)
- Sealed to IP66 and NEMA/UL 1, 4, 12, and 13
- -40 °C [-40 °F] standard construction for side rotary and plunger actuated switches suitable for many severe outdoor environments
- Dual bearing design on side rotary actuators reduces side loading and enhances mechanical life
- Variety of NC and NO double-break snap-action or slow-action contact options
- Silver contacts for power switching or gold-plated contacts for low energy loads
- Normally closed contacts are positive opening \odot , and conform to EN/IEC 60947-5-1-3 to provide forced opening of the normally closed contact. Each contact throw is electrically isolated to accept different voltages (Form Zb contacts). Double pole double throw (2NC/2NO) contact option require same polarity for each pole. (Form Za for each pole)
- Contact blocks are available as snap action or slow action
- Mechanical life up to 10 million operations

POTENTIAL APPLICATIONS

- Passenger elevators
- Commercial appliances
- Escalators/moving stairs
- Scissor/platform lifts
- Material handling
- Machine tool equipment
- Off-road equipment

PORTFOLIO

The GLC Series, GLD Series, and GLE Series are a segment of Honeywell's global limit switch offering. The global limit switch products also include the GLA Series, the GLL Series, the NGC Series, and SZL-VL series. In addition to the global limit switch series, Honeywell provides a comprehensive line of medium duty industrial limit switches (CE Series, E6/V6 Series, LS Series) and heavy-duty **HDLS Series (Heavy Duty Limit Switch)**.

¹CCC certification is not available on the GL Series Switches sold within Europe, Middle East, and Africa. Option for CCC certification in these regions is available upon request.

MICRO SWITCH Global Miniature Limit Switches, GLC | GLD | GLE Series

Table 1. Specifications

Characteristic	Parameter
Housing material	GLC Series and GLE Series: Electrostatic epoxy coated zinc GLD Series: High-strength glass re-enforced thermoplastic
Actuators	Side rotary, top pin plunger, top roller plunger, top roller lever, top wobble actuator
Termination	0.5-14 NPT, PG 13,5, 20 mm, PF 1/2, Deutsch style 4-pin connector other cable/connector options available, contact the Honeywell Representative
Contact options*	GLC metal housing and GLD plastic housing: 1NC/1NO, 2NC, 2NO GLE metal housing, 1NC/1NO, 2NC, 2NO, 2NC/2NO
Contact type	snap-action, slow-action break-before-make (BBM), slow-action make-before-break (MBB), slow action
Contact material	silver (standard), gold plated (low-energy applications)
Thermal current (Ith)	10 A
Rated insulation voltage	300 V
Rated impulse voltage	2.5 kV
Sealing	NEMA 1, 4, 12, 13; IP66
Operating temperature	-40 °C to 85 °C [-40 °F to 185 °F]
Mechanical life	Up to 10 million cycles
Pollution code	3
Max. actuation frequency	250 operations/minute; 100 operations/minute (wobbles)
Shock	50 g per IEC 60068-2-27
Vibration	10 g per IEC 60068-2-6
Approvals	CE, UL, CSA and CCC ¹
Conforming to standards	CE, EN50047, IEC/EN 60947-5-1; CSA C22.2 #14; UL 508; CCC ₁ , GB14048.5; EN45545-2 (GLC/GLE)

*All normally closed contacts are positive opening (→).

The two contact elements are Zb (electrically separated) except the 2NC/2NO contacts requires same polarity each pole (Za).

¹CCC certification is not available on the GL Series Switches sold within Europe, Middle East, and Africa. Option for CCC certification in these regions is available upon request.



Table 2. Electrical Rating

IEC 60947-5-1 (EN60947-5-1) AC 15, A300; DC 13, Q300

Silver Contacts								Gold Contacts
ac				dc				1 V 10 µA min. 50 V 100 mA max.
A300 Ue	AC15 Ie	VA		Q300 Ue	DC13 Ie	VA		
Volts	Amps	Make	Break	Volts	Amps	Make	Break	
120	6	7200	720	125	0.55	69	69	
240	3	7200	720	250	0.27	69	69	

MICRO SWITCH Global Miniature Limit Switches, GLC | GLD | GLE Series

Figure 1. Product Nomenclature

GL	C	A	01	A1A	L	
Switch Type	Body	Conduit	Basic Switch	Head/Actuator	Modification Codes For Actuator types beginning with A*	
GLS Series Global Limit Switch	C Metal, miniature	A 1/2-14 NPT	01 SPDT snap action	A1A Side rotary, fixed, 19 mm x 6 mm nylon roller	E7B Wobble, coil spring	1 CW rotation only
	D Plastic, miniature	B PG 13,5	03 SPDT, BBM slow acting	A1B Side rotary, fixed, 19 mm x 6 mm steel roller	F^Δ Adj. top roller lever, Ø27,3 mm x 5 mm roller	2 CCW rotation only
	E Metal, three conduit	C 20 mm	04 SPDT, MBB slow acting	A2A Side rotary, adjust., 19 mm x 6 mm nylon roller	K8A Cat whisker, 140 mm	3 Lever to right
			05 DPST, 2NO slow acting	A2B Side rotary, adjust., 19 mm x 6 mm steel roller	K8B Cat whisker, 190 mm	4 Lever to left
			06 DPST, 2NC slow acting	A4J Side rotary, adjust., 140 mm aluminum rod	K8D Cat whisker, 165 mm	5 Lever to mounting surf.
			07 SPDT, snap action, gold cont.	A4L Side rotary, adjust., 200 mm aluminum rod	A1 Side rotary, fixed, no roller	for Actuator/Type C
			24 DPDT, snap action, Body E	A5A Side rotary, offset, 19 mm x 6 mm nylon roller	A2 Side rotary, adjustable, no roller	6 Roller perpendicular to mtg. surf.
			32 DPDT, snap action, gold cont. Body E	A5B Side rotary, offset, 19 mm x 6 mm steel roller	A1Y Side rotary, fixed, 50 mm x 10 mm rubber roller	
			33 SPDT, BBM slow acting, gold contacts	A9A Side rotary, conveyor lever	A2Y Side rotary, adj., 50 mm x 10 mm rubber roller	for Actuator/Type D
			34 SPDT, MBB slow acting, gold contacts	B Top pin plunger	^Δ Available with D style body (plastic) only.	4 Lever to right, hinge to left
			35 DPST, 2NO slow acting, gold contacts	C Top roller plunger		
			36 DPST, 2NC slow acting, gold contacts	D Top roller lever		

NOTE: not all combinations of model codes are available. Please contact your Honeywell provider/representative for assistance.

*For Type A modification codes, more than one code may be permissible. For example, GLCA01A1B-13 is a side rotary, lever-actuated switch, GLCA01A1B, adjusted for clockwise actuation only. The operating shaft is to the right side of the switch when viewing the switch from the front (label side).

MICRO SWITCH Global Miniature Limit Switches, GLC | GLD | GLE Series

MICRO SWITCH™ GLC SERIES ORDER GUIDE/RECOMMENDED LISTINGS

For listings not shown, contact your Honeywell representative.

Table 3. Side Rotary, Plastic Roller

	Contacts	Contact Type	Contact Mtl	Conduit	Oper. Torque	Bar Chart ¹	Listing
	1NC/1NO	Snap action 	Silver	0.5-14 NPT	0,12 Nm max. [1.1 in-lb max.]		GLCA01A1A
			Silver	PG 13,5			GLCB01A1A
			Silver	20 mm			GLCC01A1A
			Gold plated	20 mm			GLCC07A1A
	1NC/1NO	BBM, slow action 	Silver	0.5-14 NPT	0,11 Nm max. [1.0 in-lb max.]		GLCA03A1A
	2 NO	Slow action 	Silver	0.5-14 NPT	0,11 Nm max. [1.0 in-lb max.]		GLCA05A1A

¹Contact closed ■; Contact open □. *Positive opening occurs.

Table 4. Side Rotary, Metal Roller

	Contacts	Contact Type	Contact Mtl	Conduit	Oper. Torque	Bar Chart ¹	Listing
	1NC/1NO	Snap action 	Silver	0.5-14 NPT	0,12 Nm max. [1.1 in-lb max.]		GLCA01A1B
			Silver	PG 13,5			GLCB01A1B
			Silver	20 mm			GLCC01A1B
			Gold plated	PG 13,5			GLCB07A1B
			Gold plated	20 mm			GLCC07A1B
	1NC/1NO	BBM, slow action 	Silver	0.5-14 NPT	0,11 Nm max. [1.0 in-lb max.]		GLCA03A1B
				PG 13,5			GLCB03A1B
	1NC/1NO	MBB, slow action 	Silver	0.5-14 NPT	0,11 Nm max. [1.0 in-lb max.]		GLCA04A1B
				PG 13,5			GLCB04A1B
	2 NC	Slow action 	Silver	PG 13,5	0,11 Nm max. [1.0 in-lb max.]		GLCB06A1B

¹Contact closed ■; Contact open □. *Positive opening occurs.

Table 5. Side Rotary Adjustable, Plastic Roller

	Contacts	Contact Type	Contact Mtl	Conduit	Oper. Torque	Bar Chart ¹	Listing
	1NC/1NO	Snap action 	Silver	0.5-14 NPT	0,12 Nm max. [1.1 in-lb max.]		GLCA01A2A
			Silver	PG 13,5			GLCB01A2A
			BBM, slow action 	Silver	PG 13,5	0,11 Nm max. [1.0 in-lb max.]	

¹Contact closed ■; Contact open □. *Positive opening occurs.

MICRO SWITCH Global Miniature Limit Switches, GLC | GLD | GLE Series

Table 6. Side Rotary Adjustable, Metal Roller

	Contacts	Contact Type	Contact Mtl	Conduit	Oper. Torque	Bar Chart ¹	Listing
	1NC/1NO	Snap action 	Silver	0.5-14 NPT	0,12 Nm max. [1.1 in-lb max.]		GLCA01A2B
			Silver	PG 13,5			GLCB01A2B
			Gold plated	PG 13,5			GLCB07A2B
			Silver	20 mm			GLCC01A2B
			Gold plated	20 mm			GLCC07A2B
1NC/1NO	MBB, slow action 	Silver	0.5-14 NPT	0,11 Nm max. [1.0 in-lb max.]		GLCA04A2B	
1NC/1NO	BBM, slow action 	Silver	20 mm	0,11 Nm max. [1.0 in-lb max.]		GLCC03A2B	
2NC	Slow action 	Silver	PG 13,5	0,11 Nm max. [1.0 in-lb max.]		GLCB06A2B	

¹Contact closed ■; Contact open □; *Positive opening occurs.

Table 7. Side Rotary Adjustable, Metal Rod, A4J (140 mm rod) and A4L (200 mm rod)

	Contacts	Contact Type	Contact Mtl	Conduit	Oper. Torque	Bar Chart ¹	Listing
	1NC/1NO	Snap action 	Silver	0.5-14 NPT	0,12 Nm max. [1.1 in-lb max.]		GLCA01A4J
				PG 13,5			GLCB01A4J
				20 mm			GLCC01A4J
				PG13,5			GLCB01A4L

¹Contact closed ■; Contact open □; *Positive opening occurs.

Table 8. Side Rotary Offset Lever, Metal Roller

	Contacts	Contact Type	Contact Mtl	Conduit	Oper. Torque	Bar Chart ¹	Listing
	1NC/1NO	Snap action 	Silver	0.5-14NPT	0,12 Nm max. [1.1 in-lb max.]		GLCA01A5B
			Silver	PG 13,5			GLCB01A5B
	2NC	Slow action 	Silver	0.5-14 NPT	0,11 Nm max. [1.0 in-lb max.]		GLCA06A5B
			Gold plated	0.5-14 NPT			GLCA36A5B

MICRO SWITCH Global Miniature Limit Switches, GLC | GLD | GLE Series

¹Contact closed ■; Contact open □. *Positive opening occurs.

Table 9. Side Rotary Conveyor Lever, Ceramic Roller

	Contacts	Contact Type	Contact Mtl	Conduit	Oper. Torque	Bar Chart ¹	Listing
	1NC/1NO	Snap action 	Silver	0.5-14 NPT	0,12 Nm max. [1.1 in-lb max.]		GLCA01A9A
				PG 13,5			GLCB01A9A
				20 mm			GLCC01A9A

¹Contact closed ■; Contact open □. *Positive opening occurs.

Table 10. Top Pin Plunger

	Contacts	Contact Type	Contact Mtl	Conduit	Oper. Force	Bar Chart ¹	Listing
	1NC/1NO	Snap action 	Silver	0.5-14 NPT	16 N max. [3.6 lb max.]		GLCA01B
			Silver	PG 13,5			GLCB01B
			Silver	20 mm			GLCC01B
			Gold plated	PG 13,5			GLCB07B
1NC/1NO	BBM, slow action 	Silver	0.5-14 NPT	14 N max. [3.2 lb max.]		GLCA03B	
			PG 13,5			GLCB03B	
1NC/1NO	MBB, slow action 	Silver	0.5-14 NPT	16 N max. [3.6 lb max.]		GLCA04B	
			PG 13,5			GLCB04B	
2 NC	Slow action 	Silver	PG 13,5	13 N max. [2.9 lb max.]		GLCB06B	

¹Contact closed ■; Contact open □. *Positive opening occurs. NOTE: Bar chart measurements are in millimeters.

Table 11. Top Roller Plunger

	Contacts	Contact Type	Contact Mtl	Conduit	Oper. Force	Bar Chart ¹	Listing
	1NC/1NO	Snap action 	Silver	0.5-14 NPT	16 N max. [3.6 lb max.]		GLCA01C
			Silver	PG 13,5			GLCB01C
			Gold plated	PG 13,5			GLCB07C
			Silver	20 mm			GLCC01C
1NC/1NO	BBM, slow action 	Silver	0.5-14 NPT	14 N max. [3.2 lb max.]		GLCA03C	
			PG 13,5			GLCB03C	
1NC/1NO	MBB, slow action 	Silver	PG 13,5	16 N max. [3.6 lb max.]		GLCB04C	
2NC	Slow action 	Silver	PG 13,5	13 N max. [2.9 lb max.]		GLCB06C	
		Gold plated	PG 13,5			GLCB36C	
		Silver	20 mm			GLCC06C	

MICRO SWITCH Global Miniature Limit Switches, GLC | GLD | GLE Series

¹Contact closed ■; Contact open □. *Positive opening occurs. NOTE: Bar chart measurements are in millimeters.

Table 12. Top Roller Lever

	Contacts	Contact Type	Contact Mtl	Conduit	Oper. Force	Bar Chart ¹	Listing
	1NC/1NO	Snap action 	Silver	0.5-14 NPT	10 N max. [2.2 lb max.]		GLCA01D
			Silver	PG 13,5			GLCB01D
			Gold plated	PG 13,5			GLCB07D
			Silver	20 mm			GLCC01D
1NC/1NO	BBM, slow action 	Silver	0.5-14 NPT	9 N max. [2.0 lb max.]		GLCA03D	
		Silver	PG 13,5			GLCB03D	
		Gold plated	PG 13,5			GLCB33D	
1NC/1NO	MBB, slow action 	Silver	PG 13,5	10 N max. [2.2 lb max.]		GLCB04D	
2NC	Slow action 	Silver	20 mm	8 N max. [1.8 lb max.]		GLCC06D	
		Gold plated	0.5-14 NPT			GLCA36D	

¹Contact closed ■; Contact open □. *Positive opening occurs. NOTE: Bar chart measurements are in millimeters.

Table 13. Coil Spring Wobble, 130 mm

	Contacts	Contact Type	Contact Mtl	Conduit	Oper. Force	Bar Chart ¹	Listing
	1NC/1NO	Snap action 	Silver	0.5-14 NPT	1,3 N max. [0.29 lb] max.		GLCA01E7B
			Silver	PG 13,5			GLCB01E7B
			Silver	20 mm			GLCC01E7B
			Gold plated	PG 13,5			GLCB07E7B
1NC/1NO	BBM, slow action 	Silver	0.5-14 NPT	1,1 N max. [0.25 lb] max.		GLCA03E7B	
2NC	Slow action 	Silver	0.5-14 NPT	1,1 N max. [0.25 lb] max.		GLCA06E7B	

¹Contact closed ■; Contact open □.

Table 14. Cat Whisker Wobble, 140 mm

	Contacts	Contact Type	Contact Mtl	Conduit	Oper. Force	Bar Chart ¹	Listing
	1NC/1NO	Snap action 	Silver	0.5-14 NPT	0,9 N max. [0.19 lb] max.		GLCA01K8A
				PG 13,5			GLCB01K8A

¹Contact closed ■; Contact open □.

MICRO SWITCH Global Miniature Limit Switches, GLC | GLD | GLE Series

Table 15. Cat Whisker Wobble, 190 mm

	Contacts	Contact Type	Contact Mtl	Conduit	Oper. Force	Bar Chart ¹	Listing
	1NC/1NO	Snap action 	Silver	0.5-14 NPT	0,9 N max. [0.19 lb] max.		GLCA01K8B
				PG 13,5			
	1NC/1NO	BBM, slow action 	Silver	0.5-14 NPT	0,7 N max. [0.16 lb] max.		GLCA03K8B

¹Contact closed ■ Contact open □

Figure 1. GLC Side Rotary • A1, A1A, A1B, and A1Y



Figure 2. GLC Side Rotary • A2, A2A, A2B, and A2Y



Figure 3. GLC Side Rotary Rod • A4J (140 mm) & A4L (200 mm)



Figure 4. GLC Side Rotary • A5A and A5B

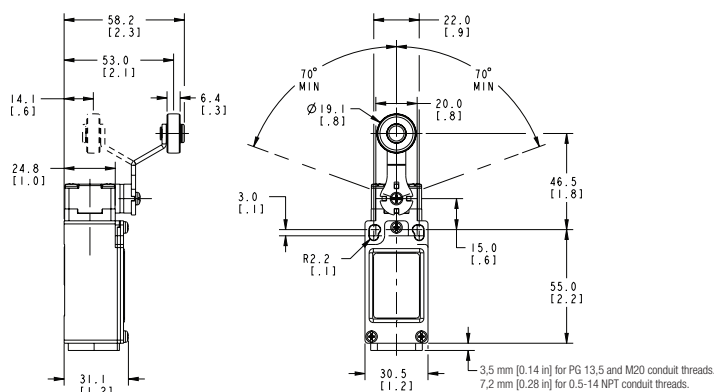

Figure 5. GLC Side Rotary • A9A



Figure 6. GLC Top Pin Plunger



MICRO SWITCH Global Miniature Limit Switches, GLC | GLD | GLE Series

Figure 7. GLC Top Roller Plunger



Figure 9. GLC Wobble • E7B



Figure 8. GLC Top Roller Arm



Figure 10. GLC Wobble • K8A/K8B



Figure 11. GLC Conduit



MICRO SWITCH Global Miniature Limit Switches, GLC | GLD | GLE Series

MICRO SWITCH™ GLD SERIES ORDER GUIDE/RECOMMENDED LISTINGS

For listings not shown, contact your Honeywell representative.

Table 16. Side Rotary, Plastic Roller

	Contacts	Contact Type	Contact Mtl	Conduit	Oper. Torque	Bar Chart ¹	Listing
	1NC/1NO	Snap action 	Silver	0.5-14 NPT	0,12 Nm max. [1.1 in-lb max.]		GLDA01A1A
			Silver	PG 13,5			GLDB01A1A
			Gold plated	PG 13,5			GLDB07A1A
			Silver	20 mm			GLDC01A1A
	1NC/1NO	BBM, slow action 	Silver	0.5-14 NPT PG 13,5	0,11 Nm max. [1.0 in-lb max.]		GLDA03A1A GLDB03A1A
1NC/1NO	MBB, slow action 	Silver	PG 13,5	0,11 Nm max. [1.0 in-lb max.]		GLDB04A1A	
2NO	Slow action 	Silver	20 mm	0,11 Nm max. [1.0 in-lb max.]		GLDC05A1A	
2NC	Slow action 	Silver	20 mm	0,11 Nm max. [1.0 in-lb max.]		GLDC06A1A	

¹Contact closed ■, Contact open □. *Positive opening occurs.

Table 17. Side Rotary, Metal Roller

	Contacts	Contact Type	Contact Mtl	Conduit	Oper. Torque	Bar Chart ¹	Listing
	1NC/1NO	Snap action 	Silver	0.5-14 NPT	0,12 Nm max. [1.1 in-lb max.]		GLDA01A1B
			Silver	PG 13,5			GLDB01A1B
			Gold plated	PG 13,5			GLDB07A1B
			Silver	20 mm			GLDC01A1B
			Gold plated	20 mm			GLDC07A1B
1NC/1NO	BBM, slow action 	Silver	0.5-14 NPT PG 13,5	0,11 Nm max. [1.0 in-lb max.]		GLDA03A1B GLDB03A1B	
2NC	Slow action 	Silver	0.5-14 NPT PG 13,5 20 mm	0,11 Nm max. [1.0 in-lb max.]		GLDA06A1B GLDB06A1B GLDC06A1B	

¹Contact closed ■, Contact open □. *Positive opening occurs.

MICRO SWITCH Global Miniature Limit Switches, GLC | GLD | GLE Series

Table 18. Side Rotary Adjustable, Plastic Roller

	Contacts	Contact Type	Contact Mtl	Conduit	Oper. Torque	Bar Chart ¹	Listing
	1NC/1NO	Snap action 	Silver	0.5-14 NPT	0,12 Nm max. [1.1 in-lb max.]		GLDA01A2A
				PG 13,5			GLDB01A2**
			PG 13,5	GLDB01A2A			
			20 mm	GLDC01A2A			
			Gold plated	PG 13,5			GLDB07A2A
	1NC/1NO	BBM, slow action 	Silver	PG 13,5	0,11 Nm max. [1.0 in-lb max.]		GLDB03A2A
	2NO	Slow action 	Silver	20 mm	0,11 Nm max. [1.0 in-lb max.]		GLDC05A2A
	2NC	Slow action 	Silver	0.5-14 NPT	0,11 Nm max. [1.0 in-lb max.]		GLDA06A2A
			Silver	PG 13,5			GLDB06A2A

¹Contact closed ■; Contact open □. *Positive opening occurs. **No roller

Table 19. Side Rotary Adjustable, Metal Roller

	Contacts	Contact Type	Contact Mtl	Conduit	Oper. Torque	Bar Chart ¹	Listing
	1NC/1NO	Snap action 	Silver	0.5-14 NPT	0,12 Nm max. [1.1 in-lb max.]		GLDA01A2B
			Gold plated	0.5-14 NPT			GLDA07A2B
			Silver	PG 13,5			GLDB01A2B
			Gold plated	PG 13,5			GLDB07A2B
			Silver	20 mm			GLDC01A2B
	1NC/1NO	MBB, slow action 	Silver	0.5-14 NPT	0,11 Nm max. [1.0 in-lb max.]		GLDA04A2B
	2NO	Slow action 	Silver	0.5-14 NPT	0,11 Nm max. [1.0 in-lb max.]		GLDA05A2B

¹Contact closed ■; Contact open □. *Positive opening occurs.

MICRO SWITCH Global Miniature Limit Switches, GLC | GLD | GLE Series

Table 20. Side Rotary Adjustable, Metal Rod

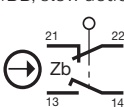
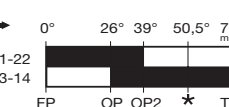
	Contacts	Contact Type	Contact Mtl	Conduit	Oper. Torque	Bar Chart ¹	Listing
	1NC/1NO	Snap action 	Silver	0.5-14 NPT	0,12 Nm max. [1.1 in-lb max.]		GLDA01A4J
				PG 13,5			GLDB01A4J
				20 mm			GLDC01A4J
	1NC/1NO	BBM, slow action 	Silver	20 mm	0,11 Nm max. [1.0 in-lb max.]		GLDC03A4J
	1NC/1NO	MBB, slow action 	Silver	0.5-14 NPT	0,11 Nm max. [1.0 in-lb max.]		GLDA04A4J

¹Contact closed ■; Contact open □. *Positive opening occurs.

Table 21. Side Rotary Offset Lever, Metal Roller

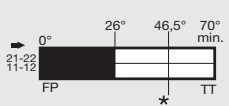
	Contacts	Contact Type	Contact Mtl	Conduit	Oper. Torque	Bar Chart ¹	Listing
	1NC/1NO	Snap action 	Silver	0.5-14NPT	0,12 Nm max. [1.1 in-lb max.]		GLDA01A5B
			Silver	PG 13,5			GLDB01A5B
			Silver	20 mm			GLDC01A5B
	2NC	Slow action 	Gold plated	PG 13,5	0,11 Nm max. [1.0 in-lb max.]		GLDB36A5B

¹Contact closed ■; Contact open □. *Positive opening occurs.

Table 22. Side Rotary Conveyor Lever, Ceramic Roller

	Contacts	Contact Type	Contact Mtl	Conduit	Oper. Torque	Bar Chart ¹	Listing
	1NC/1NO	Snap action 	Silver	0.5-14 NPT	0,12 Nm max. [1.1 in-lb max.]		GLDA01A9A
			Gold plated	0.5-14 NPT			GLDA07A9A
			Silver	20 mm			GLDC01A9A
	1NC/1NO	BBM, slow action 	Silver	0.5-14 NPT	0,11 Nm max. [1.0 in-lb max.]		GLDA03A9A
	2NC	Slow action 	Silver	0.5-14 NPT	0,11 Nm max. [1.0 in-lb max.]		GLDA06A9A

¹Contact closed ■; Contact open □. *Positive opening occurs.

MICRO SWITCH Global Miniature Limit Switches, GLC | GLD | GLE Series

Table 23. Side Rotary, 50 mm Rubber Roller

	Contacts	Contact Type	Contact Mtl	Conduit	Oper. Torque	Bar Chart ¹	Listing
	1NC/1NO	Snap action 	Silver	0.5-14 NPT	0,12 Nm max. [1.1 in-lb max.]		GLDA01A1Y
				PG 13,5			GLDB01A1Y
				20 mm			GLDC01A1Y
	1NC/1NO	BBM, slow action 	Silver	0.5-14 NPT	0,11 Nm max. [1.0 in-lb max.]		GLDA03A1Y
				PG 13,5			GLDB03A1Y

¹Contact closed ■; Contact open □. *Positive opening occurs.

Table 24. Side Rotary Adjustable, 50 mm Rubber Roller

	Contacts	Contact Type	Contact Mtl	Conduit	Oper. Torque	Bar Chart ¹	Listing
	1NC/1NO	Snap action 	Silver	0.5-14 NPT	0,12 Nm max. [1.1 in-lb max.]		GLDA01A2Y
				PG 13,5			GLDB01A2Y
				20 mm			GLDC01A2Y
	1NC/1NO	BBM, slow action 	Silver	0.5-14 NPT	0,11 Nm max. [1.0 in-lb max.]		GLDA03A2Y
				PG 13,5			GLDB03A2Y

¹Contact closed ■; Contact open □. *Positive opening occurs.

Table 25. Top Pin Plunger

	Contacts	Contact Type	Contact Mtl	Conduit	Oper. Torque	Bar Chart ¹	Listing
	1NC/1NO	Snap action 	Silver	0.5-14 NPT	16 N max. [3.6 lb max.]		GLDA01B
			Silver	PG 13,5			GLDB01B
			Gold plated	PG 13,5			GLDB07B
			Silver	20 mm			GLDC01B
			Gold plated	20 mm			GLDC07B
	1NC/1NO	BBM, slow action 	Silver	0.5-14NPT	14 N max. [3.2 lb max.]		GLDA03B
				PG 13,5			GLDB03B
	1NC/1NO	MBB, slow action 	Silver	0.5-14 NPT	16 N max. [3.6 lb max.]		GLDA04B
				PG 13,5			GLDB04B
				20 mm			GLDC04B
	2 NO	Slow action 	Silver	20 mm	13 N max. [2.9 lb max.]		GLDC05B

MICRO SWITCH Global Miniature Limit Switches, GLC | GLD | GLE Series

¹Contact closed ■, Contact open □. *Positive opening occurs. NOTE: Bar chart measurements are in millimeters.

Table 26. Top Roller Plunger

Contacts	Contact Type	Contact Mtl	Conduit	Oper. Force	Bar Chart ¹	Listing
1NC/1NO	Snap action 	Silver	0.5-14 NPT	16 N max. [3.6 lb max.]		GLDA01C
		Gold plated	0.5-14 NPT			GLDA07C
		Silver	PG 13,5			GLDB01C
		Gold plated	PG 13,5			GLDB07C
		Silver	20 mm			GLDC01C
1NC/1NO	BBM, slow action 	Silver	0.5-14 NPT	14 N max. [3.2 lb max.]		GLDA03C
		Silver	PG 13,5			GLDB03C
		Gold plated	PG 13,5			GLDB33C
		Silver	20 mm			GLDC03C
1NC/1NO	MBB, slow action 	Silver	PG 13,5	16 N max. [3.6 lb max.]		GLDB04C
2NO	Slow action 	Silver	20 mm	13 N max. [2.9 lb max.]		GLDC05C
2NC	Slow action 	Silver	0.5-14 NPT	13 N max. [2.9 lb max.]		GLDA06C
		Silver	PG 13,5			GLDB06C
		Gold plated	PG 13,5			GLDB36C
		Silver	20 mm			GLDC06C



¹Contact closed ■, Contact open □. *Positive opening occurs. NOTE: Bar chart measurements are in millimeters.

Table 27. Top Roller Lever

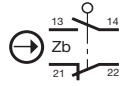
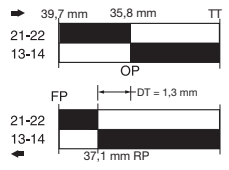
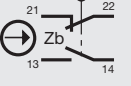
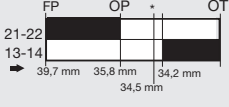
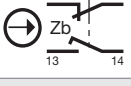
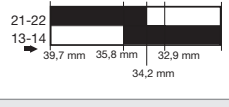
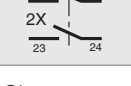
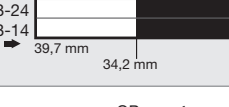
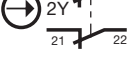
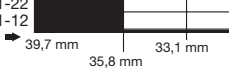
Contacts	Contact Type	Contact Mtl	Conduit	Oper. Force	Bar Chart ¹	Listing
1NC/1NO	Snap action 	Silver	0.5-14 NPT	10 N max. [2.2 lb max.]		GLDA01D
			PG 13,5			GLDB01D
			20 mm			GLDC01D
1NC/1NO	BBM, slow action 	Silver	0.5-14 NPT	9 N max. [2.0 lb max.]		GLDA03D
			PG 13,5			GLDB03D
			20 mm			GLDC03D
1NC/1NO	MBB, slow action 	Silver	PG 13,5	10 N max. [2.2 lb max.]		GLDB04D
2NO	Slow action 	Silver	20 mm	8 N max. [1.8 lb max.]		GLDC05D
2NC	Slow action 	Silver	0.5-14 NPT	8 N max. [1.8 lb max.]		GLDA06D
			20 mm			GLDC06D

¹Contact closed ■, Contact open □. *Positive opening occurs. NOTE: Bar chart measurements are in millimeters.

MICRO SWITCH Global Miniature Limit Switches, GLC | GLD | GLE Series

Table 28. Coil Spring Wobble, 130 mm

	Contacts	Contact Type	Contact Mtl	Conduit	Oper. Force	Bar Chart ¹	Listing
	1NC/1NO	Snap action 	Silver	0.5-14 NPT	1,3 N max. [0.29 lb max.]		GLDA01E7B
				PG 13,5			GLDB01E7B
				20 mm			GLDC01E7B
	1NC/1NO	BBM, slow action 	Silver	0.5-14 NPT	1,1 N max. [0.25 lb max.]		GLDA03E7B

¹Contact closed ■; Contact open □.

Table 29. Cat Whisker Wobble, 190 mm

	Contacts	Contact Type	Contact Mtl	Conduit	Oper. Force	Bar Chart ¹	Listing
	1NC/1NO	Snap action 	Silver	0.5-14 NPT	0,9 N max. [0.19 lb max.]		GLDA01K8B
				PG 13,5			GLDB01K8B
				20 mm			GLDC01K8B
	1NC/1NO	BBM, slow action 	Silver	0.5-14 NPT	0,7 N max. [0.16 lb max.]		GLDA03K8B

¹Contact closed ■; Contact open □.

MICRO SWITCH Global Miniature Limit Switches, GLC | GLD | GLE Series

MICRO SWITCH™ **GLD** DIMENSIONAL DRAWINGS mm [in]

Figure 12. GLD Side Rotary • A1, A1A, A1B, and A1Y



Figure 15. GLD Side Rotary • A5A and A5B



Figure 16. GLD Side Rotary • A9A



Figure 13. GLD Side Rotary • A2, A2A, A2B, and A2Y



Figure 17. GLD Top Pin Plunger



Figure 14. GLD Side Rotary Rod • A4J (140 mm) & A4L (200 mm)



MICRO SWITCH Global Miniature Limit Switches, GLC | GLD | GLE Series

MICRO SWITCH™ GLD DIMENSIONAL DRAWINGS mm [in]

Figure 18. GLD Top Roller Plunger



Figure 20. GLD Wobble • E7B



Figure 19. GLD Top Roller Arm



Figure 21. GLD Wobble • K8A/K8B



Figure 22. GLD Conduit



MICRO SWITCH Global Miniature Limit Switches, GLC | GLD | GLE Series

MICRO SWITCH™ GLE SERIES ORDER GUIDE/RECOMMENDED LISTINGS

For listings not shown, contact your Honeywell representative.

Table 30. Side Rotary, Plastic Roller

	Contacts	Contact Type	Contact Mtl	Conduit †	Oper. Torque	Bar Chart ¹	Listing
	1NC/1NO	Snap action 	Silver	0.5-14 NPT	0,12 Nm max. [1.1 in-lb max.]		GLEA01A1A
				PG 13,5			GLEB01A1A
	2NC/2NO	Snap action 	Gold plated	0.5-14 NPT	0,165 Nm max. [1.6 in-lb max.]		GLEA32A1A
				PG 13,5			GLEB32A1A
	2NC	Slow action 	Silver	PG 13,5	0,11 Nm max. [1.0 in-lb max.]		GLEB06A1A
			Gold plated	0.5-14 NPT			GLEA36A1A

¹Contact closed ■; Contact open □. *Positive opening occurs. † 0.5-14 NPT conduit option includes adapter.

Table 31. Side Rotary, Metal Roller

	Contacts	Contact Type	Contact Mtl	Conduit †	Oper. Torque	Bar Chart ¹	Listing
	1NC/1NO	Snap action 	Silver	0.5-14 NPT	0,12 Nm max. [1.1 in-lb max.]		GLEA01A1B
			Silver	PG 13,5			GLEB01A1B
			Gold plated	PG 13,5			GLEB07A1B
			Silver	20 mm			GLEC01A1B
	2NC/2NO	Snap action 	Silver	0.5-14 NPT	0,165 Nm max. [1.6 in-lb max.]		GLEA24A1B
			Gold plated	PG 13,5			GLEB24A1B
			Silver	20 mm			GLEC24A1B
	1NC/1NO	MBB, slow action 	Silver	PG 13,5	0,11 Nm max. [1.0 in-lb max.]		GLEB04A1B

¹Contact closed ■; Contact open □. *Positive opening occurs. † 0.5-14 NPT conduit option includes adapter.

MICRO SWITCH Global Miniature Limit Switches, GLC | GLD | GLE Series

Table 32. Side Rotary Adjustable, Plastic Roller

	Contacts	Contact Type	Contact Mtl	Conduit †	Oper. Torque	Bar Chart ¹	Listing
	1NC/1NO	Snap action 	Silver	0.5-14 NPT	0,12 Nm max. [1.1 in-lb max.]		GLEA01A2A
				PG 13,5			
	2NC/2NO	Snap action 	Silver	0.5-14 NPT	0,165 Nm max. [1.6 in-lb max.]		GLEA24A2A
				20 mm			GLEC24A2A

¹Contact closed ■; Contact open □. *Positive opening occurs. † 0.5-14 NPT conduit option includes adapter.

Table 33. Side Rotary Adjustable, Metal Roller

	Contacts	Contact Type	Contact Mtl	Conduit †	Oper. Torque	Bar Chart ¹	Listing
	1NC/1NO	Snap action 	Silver	0.5-14 NPT	0,12 Nm max. [1.1 in-lb max.]		GLEA01A2B
				PG 13,5			GLEB01A2B
				20 mm			GLEC01A2B
			Gold plated	PG 13,5			GLEB07A2B
	2NC/2NO	Snap action 	Silver	0.5-14 NPT	0,165 Nm max. [1.6 in-lb max.]		GLEA24A2B
				PG 13,5			GLEB24A2B

¹Contact closed ■; Contact open □. *Positive opening occurs. † 0.5-14 NPT conduit option includes adapter.

Table 34. Side Rotary Adjustable, Metal Rod, A4J (140 mm Rod)

	Contacts	Contact Type	Contact Mtl	Conduit †	Oper. Torque	Bar Chart ¹	Listing
	1NC/1NO	Snap action 	Silver	0.5-14 NPT	0,12 Nm max. [1.1 in-lb max.]		GLEA01A4J
				PG 13,5			GLEB01A4J
				20 mm			GLEC01A4J
	2NC/2NO	Snap action 	Silver	0.5-14 NPT	0,165 Nm max. [1.6 in-lb max.]		GLEA24A4J

¹Contact closed ■; Contact open □. *Positive opening occurs. † 0.5-14 NPT conduit option includes adapter.

MICRO SWITCH Global Miniature Limit Switches, GLC | GLD | GLE Series

Table 35. Side Rotary Offset Lever, Plastic Roller

	Contacts	Contact Type	Contact Mtl	Conduit †	Oper. Torque	Bar Chart ¹	Listing
	1NC/1NO	Snap action 	Silver	0.5-14 NPT	0,12 Nm max. [1.1 in-lb max.]		GLEA01A5A
				PG 13,5			GLEB01A5A

¹Contact closed ■, Contact open □. *Positive opening occurs. † 0.5-14 NPT conduit option includes adapter.

Table 36. Side Rotary Offset Lever, Metal Roller

	Contacts	Contact Type	Contact Mtl	Conduit †	Oper. Torque	Bar Chart ¹	Listing
	1NC/1NO	Snap action 	Silver	0.5-14 NPT	0,12 Nm max. [1.1 in-lb max.]		GLEA01A5B
				PG 13,5			GLEB01A5B
	1NC/1NO	BBM, slow action 	Silver	PG 13,5	0,11 Nm max. [1.0 in-lb max.]		GLEB03A5B
2NC/2NO	Snap action 	Silver	0.5-14 NPT	0,165 Nm max. [1.6 in-lb max]		GLEA24A5B	

¹Contact closed ■, Contact open □. *Positive opening occurs. † 0.5-14 NPT conduit option includes adapter.

Table 37. Side Rotary Conveyor Lever, Ceramic Roller

	Contacts	Contact Type	Contact Mtl	Conduit †	Oper. Torque	Bar Chart ¹	Listing
	1NC/1NO	Snap action 	Silver	PG 13,5	0,12 Nm max. [1.1 in-lb max.]		GLEB01A9A
				20 mm			GLEC01A9A

MICRO SWITCH Global Miniature Limit Switches, GLC | GLD | GLE Series

¹Contact closed ■; Contact open □. *Positive opening occurs.

Table 38. Top Pin Plunger

	Contacts	Contact Type	Contact Mtl	Conduit [†]	Oper. Force	Bar Chart ¹	Listing
	1NC/1NO	Snap action 	Silver	0.5-14 NPT	16 N max. [3.6 lb max.]		GLEA01B
				PG 13,5			GLEB01B
				20 mm			GLEC01B
	1NC/1NO	BBM, slow action 	Silver	PG 13,5	14 N max. [3.2 lb max.]		GLEB03B
				20 mm			GLEC03B
				Gold plated			PG 13,5
2NC/2NO	Snap action 	Silver	0.5-14 NPT	13 N max. [2.9 lb max.]		GLEA24B	
			PG 13,5			GLEB24B	
		20 mm	GLEC24B				
		Gold plated	20 mm			GLEC32B	

¹Contact closed ■; Contact open □. *Positive opening occurs. NOTE: Bar chart measurements are in millimeters. [†] 0.5-14 NPT conduit option includes adapter.

Table 39. Top Roller Plunger

	Contacts	Contact Type	Contact Mtl	Conduit [†]	Oper. Force	Bar Chart ¹	Listing
	1NC/1NO	Snap action 	Silver	0.5-14 NPT	16 N max. [3.6 lb max.]		GLEA01C
				PG 13,5			GLEB01C
				20 mm			GLEC01C
	2NC/2NO	Snap action 	Silver	0.5-14 NPT	13 N max. [2.9 lb max.]		GLEA24C
				PG 13,5			GLEB24C
				20 mm			GLEC24C

¹Contact closed ■; Contact open □. *Positive opening occurs. NOTE: Bar chart measurements are in millimeters. [†] 0.5-14 NPT conduit option includes adapter.

Table 40. Top Roller Lever

MICRO SWITCH Global Miniature Limit Switches, GLC | GLD | GLE Series

	Contacts	Contact Type	Contact Mtl	Conduit †	Oper. Force	Bar Chart ¹	Listing	
	1NC/1NO	Snap action 	Silver	0.5-14 NPT	10 N max. [2.2 lb max.]		GLEA01D	
				PG 13,5				GLEB01D
				20 mm				
	2NC/2NO	Snap action 	Silver	0.5-14 NPT	3,2 N max. [0.72 lb max.]		GLEA24D	
				PG 13,5				GLEB24D
				20 mm				
2 NC	Slow action 	Silver	0.5-14 NPT	8 N max. [1.8 lb max.]		GLEA06D		

¹Contact closed ■; Contact open □. *Positive opening occurs. NOTE: Bar chart measurements are in millimeters. † 0.5-14 NPT conduit option includes adapter.

Table 41. Coil Spring Wobble, 130 mm

	Contacts	Contact Type	Contact Mtl	Conduit †	Oper. Force	Bar Chart ¹	Listing	
	1NC/1NO	Snap action 	Silver	0.5-14 NPT	1,3 N max. [0.29 lb max.]		GLEA01E7B	
				PG 13,5				GLEB01E7B
				0.5-14 NPT				
	PG 13,5	GLEB24E7B						

¹Contact closed ■; Contact open □. *Positive opening occurs. NOTE: Bar chart measurements are in millimeters. † 0.5-14 NPT conduit option includes adapter.

Table 42. Cat Whisker Wobble, 140 mm

	Contacts	Contact Type	Contact Mtl	Conduit †	Oper. Force	Bar Chart ¹	Listing	
	1NC/1NO	Snap action 	Silver	PG 13,5	0,9 N max. [0.19 lb max.]		GLEB01K8A	
			Gold plated	PG 13,5				GLEB07K8A
			2NC/2NO	Snap action 				

¹Contact closed ■; Contact open □.

MICRO SWITCH Global Miniature Limit Switches, GLC | GLD | GLE Series

MICRO SWITCH™ GLE DIMENSIONAL DRAWINGS mm [in]

Figure 23. GLE Side Rotary • A1, A1A, A1B, and A1Y



Figure 26. GLE Side Rotary • A5A and A5B



Figure 24. GLE Side Rotary • A2, A2A, A2B, and A2Y



Figure 27. GLE Side Rotary • A9A



Figure 25. GLE Side Rotary • A4J and A4L



Figure 28. GLE Top Pin Plunger



MICRO SWITCH Global Miniature Limit Switches, GLC | GLD | GLE Series

MICRO SWITCH™ GLE DIMENSIONAL DRAWINGS mm [in]

Figure 29. GLE Top Roller Plunger



Figure 31. GLE Wobble • E7B



Figure 30. GLE Top Roller Arm



Figure 32. GLE Wobble • K8A

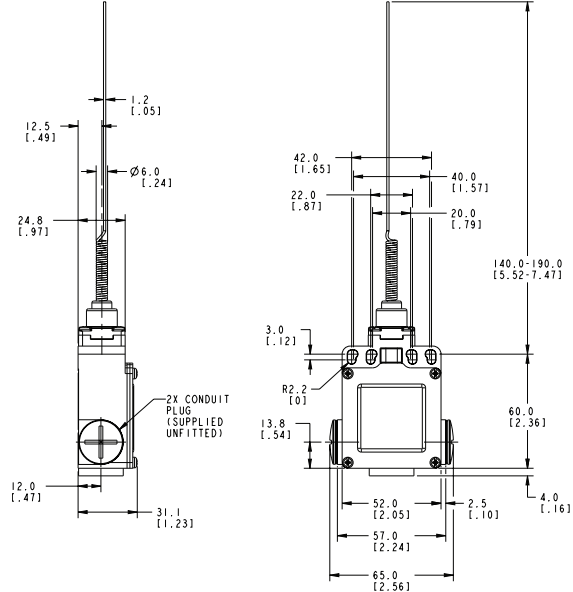

Figure 33. GLE Conduit Adapter for 0.5-14 NPT



MICRO SWITCH Global Miniature Limit Switches, GLC | GLD | GLE Series

FACTORY PRE-WIRED LIMIT SWITCHES WITH INTEGRAL CONNECTOR

Epoxy-coated Metal Limit Switches

GLCC01B-D1: Top pin plunger, 1NC/1NO snap action, with Deutsch DT style 4 pin connector

GLCC01C-D1: Top roller plunger, 1NC/1NO snap action, with Deutsch DT style 4 pin connector

GLCC06A1B-D1: Side rotary with metal roller, 2NC slow action, with Deutsch DT style 4 pin connector

Plastic Limit Switches

GLDC01A1A-D1: Side rotary with plastic roller, 1NC/1NO snap action, with Deutsch DT style 4 pin connector

GLDC01A1B-D1: Side rotary with metal roller, 1NC/1NO snap action, with Deutsch DT style 4 pin connector

GLDC01C-D1: Top roller plunger, 1NC/1NO snap action, with Deutsch DT style 4 pin connector

Note: Reference base catalog listing for switch characteristics. For example, cat. listing GLCC01B-D1 has base cat. listing GLCC01B.



FACTORY PRE-WIRED LIMIT SWITCHES WITH INTEGRAL CONNECTOR



Connector Without Limit Switch



GLZ8C-DEU: DT style 4 pin connector prewired with 6 in. of lead wires (4) and 20 mm conduit thread with jam nut



GLZ8C-PA: DT style 4 pin connector packet with all parts furnished unassembled for a 20 mm conduit thread

REPLACEMENT PARTS - BASIC SWITCHES

Body Type	Basic Switch									
	01	03	04	06	07	24	32	33	34	36
GLC	GLZ301	GLZ303	GLZ304	GLZ306	GLZ307	n/a	n/a	GLZ333	GLZ334	GLZ336
GLD	GLZ301	GLZ303	GLZ304	GLZ306	GLZ307	n/a	n/a	GLZ333	GLZ334	GLZ336
GLE	GLZ301	GLZ303	GLZ304	GLZ306	GLZ307	GLZ324	GLZ332	GLZ333	GLZ334	GLZ336

ADDITIONAL MATERIALS

The following associated literature is available on the Honeywell web site at sensing.honeywell.com:

- Product installation instructions
- Aerospace range guide
- Transportation range guide
- Limits and Machine Safety range guide
- Product application-specific information
 - Application Note: Sensors and Switches for Industrial Manual Process Valves
 - Application Note: Sensors and Switches Used in Valve Actuators and Valve Positioners
 - Industrial Machinery Switch Guide
 - Limit and Enclosed Switches Application Information
 - Limit and Enclosed Switches Operating Characteristics
 - Limit and Enclosed Switches Reference Standards
 - Limit and Enclosed Switches Typical Applications
 - Sensors and Switches in Mobile Cranes
 - Sensors and Switches in Front Loaders
 - Sensors and Switches in Elevator Applications

For more information

Honeywell Sensing and Internet of Things services its customers through a worldwide network of sales offices and distributors. For application assistance, current specifications, pricing or the nearest Authorized Distributor, visit sensing.honeywell.com or call:

Asia Pacific	+65 6355-2828
Europe	+44 (0) 1698 481481
USA/Canada	+1-800-537-6945

Honeywell Sensing and Internet of Things

9680 Old Bailes Road
Fort Mill, SC 29707
www.honeywell.com

⚠ WARNING **PERSONAL INJURY**

DO NOT USE these products as safety or emergency stop devices or in any other application where failure of the product could result in personal injury.

Failure to comply with these instructions could result in death or serious injury.

⚠ WARNING **MISUSE OF DOCUMENTATION**

- The information presented in this product sheet is for reference only. Do not use this document as a product installation guide.
- Complete installation, operation, and maintenance information is provided in the instructions supplied with each product.

Failure to comply with these instructions could result in death or serious injury.

Warranty/Remedy

Honeywell warrants goods of its manufacture as being free of defective materials and faulty workmanship. Honeywell's standard product warranty applies unless agreed to otherwise by Honeywell in writing; please refer to your order acknowledgement or consult your local sales office for specific warranty details. If warranted goods are returned to Honeywell during the period of coverage, Honeywell will repair or replace, at its option, without charge those items it finds defective.

The foregoing is buyer's sole remedy and is in lieu of all other warranties, expressed or implied, including those of merchantability and fitness for a particular purpose. In no event shall Honeywell be liable for consequential, special, or indirect damages.

While we provide application assistance personally, through our literature and the Honeywell web site, it is up to the customer to determine the suitability of the product in the application.

Specifications may change without notice. The information we supply is believed to be accurate and reliable as of this printing. However, we assume no responsibility for its use.



Компания «ЭлектроПласт» предлагает заключение долгосрочных отношений при поставках импортных электронных компонентов на взаимовыгодных условиях!

Наши преимущества:

- Оперативные поставки широкого спектра электронных компонентов отечественного и импортного производства напрямую от производителей и с крупнейших мировых складов;
- Поставка более 17-ти миллионов наименований электронных компонентов;
- Поставка сложных, дефицитных, либо снятых с производства позиций;
- Оперативные сроки поставки под заказ (от 5 рабочих дней);
- Экспресс доставка в любую точку России;
- Техническая поддержка проекта, помощь в подборе аналогов, поставка прототипов;
- Система менеджмента качества сертифицирована по Международному стандарту ISO 9001;
- Лицензия ФСБ на осуществление работ с использованием сведений, составляющих государственную тайну;
- Поставка специализированных компонентов (Xilinx, Altera, Analog Devices, Intersil, Interpoint, Microsemi, Aeroflex, Peregrine, Syfer, Eurofarad, Texas Instrument, Miteq, Cobham, E2V, MA-COM, Hittite, Mini-Circuits, General Dynamics и др.);

Помимо этого, одним из направлений компании «ЭлектроПласт» является направление «Источники питания». Мы предлагаем Вам помощь Конструкторского отдела:

- Подбор оптимального решения, техническое обоснование при выборе компонента;
- Подбор аналогов;
- Консультации по применению компонента;
- Поставка образцов и прототипов;
- Техническая поддержка проекта;
- Защита от снятия компонента с производства.



Как с нами связаться

Телефон: 8 (812) 309 58 32 (многоканальный)

Факс: 8 (812) 320-02-42

Электронная почта: org@eplast1.ru

Адрес: 198099, г. Санкт-Петербург, ул. Калинина, дом 2, корпус 4, литера А.