

General Description

The IDT8N4SV75 is a LVDS Frequency-Programmable VCXO with very flexible frequency and pull-range programming capabilities. The device uses IDT's fourth generation FemtoClock® NG technology for an optimum of high clock frequency and low phase noise performance. The device accepts 2.5V or 3.3V supply and is packaged in a small, lead-free (RoHS 6) 6-lead ceramic 5mm x 7mm x 1.55mm package.

The device can be factory-programmed to any frequency in the range of 15.476MHz to 866.67MHz and from 975MHz to 1,300MHz to the very high degree of frequency precision of 218Hz or better. The extended temperature range supports wireless infrastructure, telecommunication and networking end equipment requirements.

Features

- Fourth generation FemtoClock® NG technology
- Programmable clock output frequency from 15.476MHz to 866.67MHz and from 975MHz to 1,300MHz
- Frequency programming resolution is 218Hz and better
- Factory-programmable VCXO pull range and control voltage polarity
- Absolute pull-range (APR) programmable from ± 4.5 to ± 754.5 ppm
- One 2.5V / 3.3V LVDS clock output
- Output enable control input, LVCMOS/LVTTL compatible
- RMS phase jitter @ 156.25MHz (12kHz - 20MHz): 0.53ps (typical)
- 2.5V or 3.3V supply voltage
- -40°C to 85°C ambient operating temperature
- Lead-free (RoHS 6) 6-lead ceramic 5mm x 7mm x 1.55mm package

Block Diagram



Pin Assignment



IDT8N4SV75
6-lead ceramic 5mm x 7mm x 1.55mm
package body
CD Package
Top View

Pin Description and Characteristic Tables

Table 1. Pin Descriptions

Number	Name	Type		Description
1	VC	Input		VCXO Control Voltage input.
2	OE	Input	Pullup	Output enable pin. See Table 3A for function. LVCMOS/LVTTL interface levels.
3	GND	Power		Power supply ground.
4, 5	Q, nQ	Output		Differential clock output pair. LVDS interface levels.
6	V _{DD}	Power		Power supply pin.

NOTE: *Pullup* refers to internal input resistors. See Table 2, *Pin Characteristics*, for typical values.

Table 2. Pin Characteristics

Symbol	Parameter	Test Conditions	Minimum	Typical	Maximum	Units
C _{IN}	Input Capacitance	OE		5.5		pF
		VC		10		pF
R _{PULLUP}	Input Pullup Resistor			50		kΩ

Function Tables

Table 3A. OE Configuration

Input	
OE	Output Enable
0	Outputs Q, nQ are in high-impedance state.
1 (default)	Outputs are enabled.

Table 3B. Output Frequency Range

15.476MHz to 866.67MHz
975MHz to 1,300MHz

NOTE: Supported output frequency range. The output frequency can be programmed to any frequency in this range and to a precision of 218Hz or better.

Principles of Operation

The block diagram consists of the internal 3RD overtone crystal and oscillator which provide the reference clock f_{XTAL} of 114.285MHz. The PLL includes the FemtoClock® NG VCO along with the Pre-divider (P), the feedback divider (M) and the post divider (N). The P , M , and N dividers determine the output frequency based on the f_{XTAL} reference. The feedback divider is fractional supporting a huge number of output frequencies. Internal registers are used to hold up to two different factory pre-set configuration settings. The configuration is selected via the FSEL pin. Changing the FSEL control results in an immediate change of the output frequency to the selected register values. The P , M , and N frequency configurations support an output frequency range 15.476MHz to 866.67MHz and 975MHz to 1,300MHz.

The devices use the fractional feedback divider with a delta-sigma modulator for noise shaping and robust frequency synthesis capability. The relatively high reference frequency minimizes phase noise generated by frequency multiplication and allows more efficient shaping of noise by the delta-sigma modulator. The output frequency is determined by the 2-bit pre-divider (P), the feedback divider (M) and the 7-bit post divider (N). The feedback divider (M) consists of both a 7-bit integer portion ($MINT$) and an 18-bit fractional portion ($MFRAC$) and provides the means for high-resolution frequency generation. The output frequency f_{OUT} is calculated by:

$$f_{OUT} = f_{XTAL} \cdot \frac{1}{P \cdot N} \cdot \left[MINT + \frac{MFRAC + 0.5}{2^{18}} \right] \quad (1)$$

Table 3C. Frequency Selection

Input	
FSEL	Selects
0 (default)	Frequency 0
1	Frequency 1

Frequency Configuration

An order code is assigned to each frequency configuration and the VCXO pull-range programmed by the factory (default frequencies). For more information on the available default frequencies and order codes, please see the Ordering Information Section in this document. For available order codes, see the *FemtoClock NG Ceramic-Package XO and VCXO Ordering Product Information* document. For more information on programming capabilities of the device for custom frequency and pull range configurations, see the *FemtoClock NG Ceramic 5x7 Module Programming Guide*.

Absolute Maximum Ratings

NOTE: Stresses beyond those listed under *Absolute Maximum Ratings* may cause permanent damage to the device. These ratings are stress specifications only. Functional operation of product at these conditions or any conditions beyond those listed in the *DC Characteristics* or *AC Characteristics* is not implied. Exposure to absolute maximum rating conditions for extended periods may affect product reliability.

Item	Rating
Supply Voltage, V_{DD}	3.63V
Inputs, V_I	-0.5V to $V_{DD} + 0.5V$
Outputs, I_O (LVDS) Continuous Current Surge Current	10mA 15mA
Package Thermal Impedance, θ_{JA}	49.4°C/W (0 mps)
Storage Temperature, T_{STG}	-65°C to 150°C

DC Electrical Characteristics

Table 4A. Power Supply DC Characteristics, $V_{DD} = 3.3V \pm 5\%$, $T_A = -40^\circ C$ to $85^\circ C$

Symbol	Parameter	Test Conditions	Minimum	Typical	Maximum	Units
V_{DD}	Power Supply Voltage		3.135	3.3	3.465	V
I_{DD}	Power Supply Current			140	175	mA

Table 4B. Power Supply DC Characteristics, $V_{DD} = 2.5V \pm 5\%$, $T_A = -40^\circ C$ to $85^\circ C$

Symbol	Parameter	Test Conditions	Minimum	Typical	Maximum	Units
V_{DD}	Power Supply Voltage		2.375	2.5	2.625	V
I_{DD}	Power Supply Current			136	170	mA

Table 4C. LVCMOS/LVTTL DC Characteristic, $V_{DD} = 3.3V \pm 5\%$ or $2.5V \pm 5\%$, $T_A = -40^\circ C$ to $85^\circ C$

Symbol	Parameter	Test Conditions	Minimum	Typical	Maximum	Units
V_{IH}	Input High Voltage	$V_{DD} = 3.3V$	2		$V_{DD} + 0.3$	V
		$V_{DD} = 2.5V$	1.7		$V_{DD} + 0.3$	V
V_{IL}	Input Low Voltage	$V_{DD} = 3.3V$	-0.3		0.8	V
		$V_{DD} = 2.5V$	-0.3		0.7	V
I_{IH}	Input High Current	OE $V_{DD} = V_{IN} = 3.465V$ or $2.625V$			5	μA
I_{IL}	Input Low Current	OE $V_{DD} = 3.465V$ or $2.625V$, $V_{IN} = 0V$	-150			μA

Table 4D. LVDS DC Characteristics, $V_{DD} = 3.3V \pm 5\%$, $T_A = -40^{\circ}C$ to $85^{\circ}C$

Symbol	Parameter	Test Conditions	Minimum	Typical	Maximum	Units
V_{OD}	Differential Output Voltage		247	330	454	mV
ΔV_{OD}	V_{OD} Magnitude Change				50	mV
V_{OS}	Offset Voltage		1.14	1.23	1.31	V
ΔV_{OS}	V_{OS} Magnitude Change				50	mV

Table 4E. LVDS DC Characteristics, $V_{DD} = 2.5V \pm 5\%$, $T_A = -40^{\circ}C$ to $85^{\circ}C$

Symbol	Parameter	Test Conditions	Minimum	Typical	Maximum	Units
V_{OD}	Differential Output Voltage		247	320	454	mV
ΔV_{OD}	V_{OD} Magnitude Change				50	mV
V_{OS}	Offset Voltage		1.13	1.22	1.30	V
ΔV_{OS}	V_{OS} Magnitude Change				50	mV

AC Electrical Characteristics

Table 5A. AC Characteristics, $V_{DD} = 3.3V \pm 5\%$ or $2.5V \pm 5\%$, $T_A = -40^\circ C$ to $85^\circ C$

Symbol	Parameter	Test Conditions	Minimum	Typical	Maximum	Units
f_{OUT}	Output Frequency Q, nQ		15.476		866.67	MHz
			975		1,300	MHz
f_I	Initial Accuracy	Measured @ $25^\circ C$, $V_C = V_{DD}/2$			± 10	ppm
f_S	Temperature Stability	Option code = A or B			± 100	ppm
		Option code = E or F			± 50	ppm
		Option code = K or L			± 20	ppm
f_A	Aging	Frequency drift over 10 year life			± 3	ppm
		Frequency drift over 15 year life			± 5	ppm
f_T	Total Stability	Option code A, B (10 year life)			± 113	ppm
		Option code E, F (10 year life)			± 63	ppm
		Option code K, L (10 year life)			± 33	ppm
$f_{jit(cc)}$	Cycle-to-Cycle Jitter; NOTE 1			6	14	ps
$f_{jit(per)}$	Period Jitter; NOTE 1			4	6	ps
$f_{jit}(\emptyset)$	RMS Phase Jitter (Random); NOTE 2, 3	156.25MHz, Integration Range: 12kHz - 20MHz		0.53	0.73	ps
$f_{jit}(\emptyset)$	RMS Phase Jitter (Random); NOTE 2, 3 $f_{XTAL} = 114.285MHz$	$500MHz < f_{out} \leq 1300MHz$		0.46	0.67	ps
		$100MHz < f_{out} \leq 500MHz$		0.48	0.63	ps
		$15MHz \leq f_{out} \leq 100MHz$		0.76	1.4	ps
$\Phi_N(100)$	Single-side band phase noise, 100Hz from Carrier	156.25MHz		-67		dBc/Hz
$\Phi_N(1k)$	Single-side band phase noise, 1kHz from Carrier	156.25MHz		-89		dBc/Hz
$\Phi_N(10k)$	Single-side band phase noise, 10kHz from Carrier	156.25MHz		-113		dBc/Hz
$\Phi_N(100k)$	Single-side band phase noise, 100kHz from Carrier	156.25MHz		-118		dBc/Hz
$\Phi_N(1M)$	Single-side band phase noise, 1MHz from Carrier	156.25MHz		-127		dBc/Hz
$\Phi_N(10M)$	Single-side band phase noise, 10MHz from Carrier	156.25MHz		-137		dBc/Hz
PSNR	Power Supply Noise Rejection	50mV Sinusoidal Noise 1kHz - 50MHz		-58.7		dbc
t_R / t_F	Output Rise/Fall Time	20% to 80%	80		500	ps
odc	Output Duty Cycle		45		55	%
$t_{STARTUP}$	Device Startup Time after Power-up				15	ms

NOTES are on next page.

NOTE: Electrical parameters are guaranteed over the specified ambient operating temperature range, which is established when the device is mounted in a test socket with maintained transverse airflow greater than 500 lfm. The device will meet specifications after thermal equilibrium has been reached under these conditions.

NOTE: Characterized with $V_C = V_{DD}/2$.

NOTE: XTAL parameters (initial accuracy, temperature stability, aging and total stability) are guaranteed by manufacturing.

NOTE 1: This parameter is defined in accordance with JEDEC standard 65.

NOTE 2: Please refer to the phase noise plots.

NOTE 3: Please see the FemtoClock NG Ceramic 5x7 Modules Programming guide for more information on PLL feedback modes and the optimum configuration for phase noise.

NOTE 4: 12kHz to 20MHz.

Table 5B. VCXO Control Voltage Input (V_C) Characteristics, $V_{DD} = 3.3V \pm 5\%$ or 2.5 ± 5 , $T_A = -40^\circ C$ to $85^\circ C$

Symbol	Parameter	Test Conditions	Minimum	Typical	Maximum	Units
K_V	Oscillator Gain, NOTE 1, 2, 3	$V_{DD} = 3.3V$	7.57		477.27	ppm/V
	Oscillator Gain, NOTE 1, 2, 3	$V_{DD} = 2.5V$	10		630	ppm/V
L_{VC}	Control Voltage Linearity; NOTE 4	BSL Variation	-1	± 0.1	+1	%
BW	Modulation Bandwidth			100		kHz
Z_{VC}	VC Input Impedance			500		k Ω
$V_{C_{NOM}}$	Nominal Control Voltage			$V_{DD}/2$		V
V_C	Control Voltage Tuning Range; NOTE 4		0		V_{DD}	V

NOTE: Electrical parameters are guaranteed over the specified ambient operating temperature range, which is established when the device is mounted in a test socket with maintained transverse airflow greater than 500 lfm. The device will meet specifications after thermal equilibrium has been reached under these conditions.

NOTE 1: $V_C = 10\%$ to 90% of V_{DD} .

NOTE 2: Nominal oscillator gain: Pull range divided by the control voltage tuning range of 3.3V. E.g. for ADC_GAIN [6:0] = 000001 the pull range is $\pm 12.5\text{ppm}$, resulting in an oscillator gain of $25\text{ppm} \div 3.3V = 7.57\text{ppm/V}$.

NOTE 3: For best phase noise performance, use the lowest K_V that meets the requirements of the application.

NOTE 4: BSL = Best Straight Line Fit: Variation of the output frequency vs. control voltage V_C , in percent. V_C ranges from 10% to 90% V_{DD} .

RMS Phase Jitter



Parameter Measurement Information



2.5V LVDS Output Load Test Circuit



3.3V LVDS Output Load Test Circuit

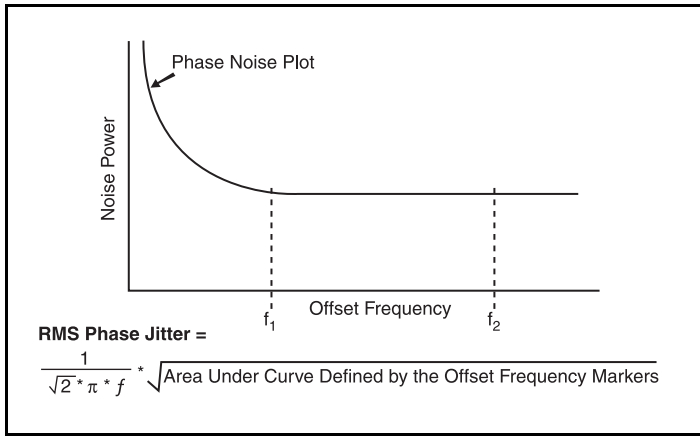

RMS Phase Jitter

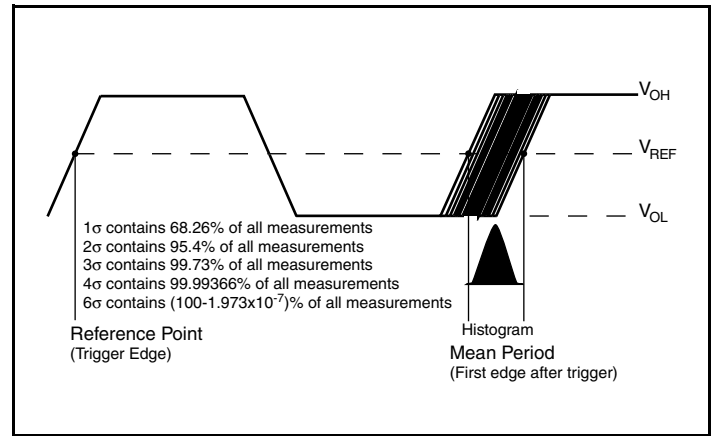

Period Jitter

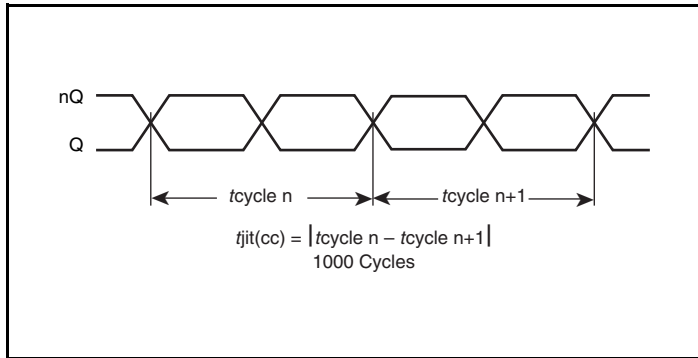

Cycle-to-Cycle Jitter

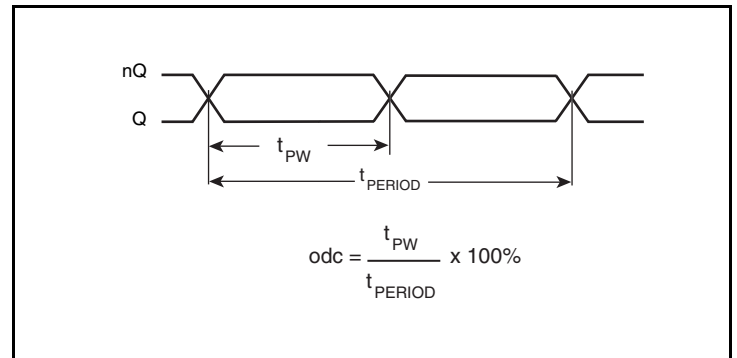

Output Duty Cycle/Pulse Width/Period

Parameter Measurement Information, continued

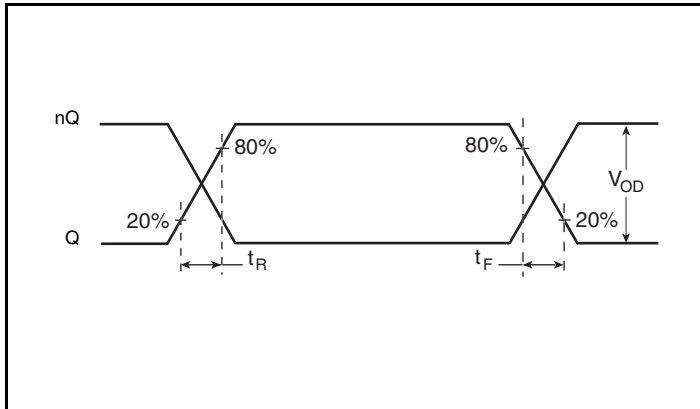

Output Rise/Fall Time

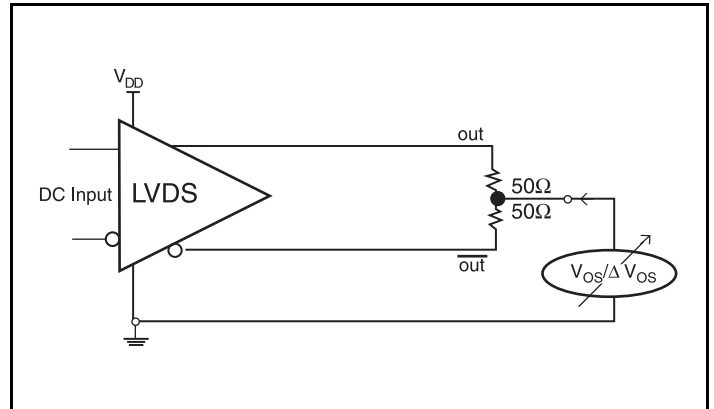

Offset Voltage Setup

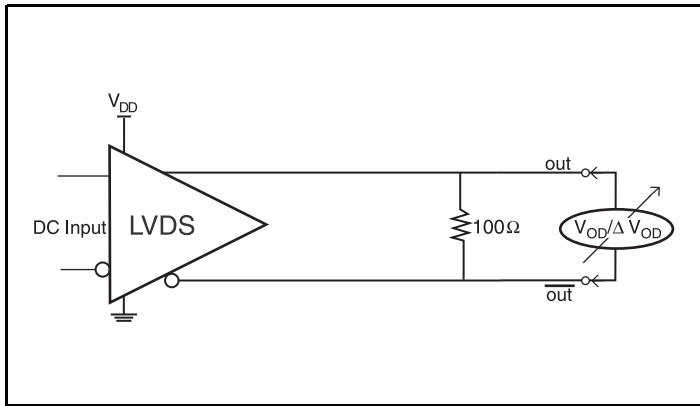

Differential Output Voltage Setup

Applications Information

LVDS Driver Termination

For a general LVDS interface, the recommended value for the termination impedance (Z_T) is between 90Ω and 132Ω . The actual value should be selected to match the differential impedance (Z_0) of your transmission line. A typical point-to-point LVDS design uses a 100Ω parallel resistor at the receiver and a 100Ω differential transmission-line environment. In order to avoid any transmission-line reflection issues, the components should be surface mounted and must be placed as close to the receiver as possible. IDT offers a full line of LVDS compliant devices with two types of output structures: current source and voltage source. The

standard termination schematic as shown in *Figure 1A* can be used with either type of output structure. *Figure 1B*, which can also be used with both output types, is an optional termination with center tap capacitance to help filter common mode noise. The capacitor value should be approximately 50pF . If using a non-standard termination, it is recommended to contact IDT and confirm if the output structure is current source or voltage source type. In addition, since these outputs are LVDS compatible, the input receiver's amplitude and common-mode input range should be verified for compatibility with the output.



Figure 1. Typical LVDS Driver Termination

Schematic Layout

Figure 2 shows an example of IDT8N4SV75 application schematic. In this example, the device is operated at $V_{DD} = 3.3V$. As with any high speed analog circuitry, the power supply pins are vulnerable to random noise. To achieve optimum jitter performance, power supply isolation is required.

In order to achieve the best possible filtering, it is recommended that the placement of the filter components be on the device side of the PCB as close to the power pins as possible. If space is limited, the $0.1\mu F$ capacitor in each power pin filter should be placed on the device side of the PCB and the other components can be placed on the opposite side.

Power supply filter recommendations are a general guideline to be used for reducing external noise from coupling into the devices. The

filter performance is designed for a wide range of noise frequencies. This low-pass filter starts to attenuate noise at approximately 10kHz. If a specific frequency noise component is known, such as switching power supplies frequencies, it is recommended that component values be adjusted and if required, additional filtering be added. Additionally, good general design practices for power plane voltage stability suggests adding bulk capacitance in the local area of all devices.

The schematic example focuses on functional connections and is not configuration specific. Refer to the pin description and functional tables in the datasheet to ensure that the logic control inputs are properly set.



Figure 2. IDT8N4SV75 Schematic Example

Power Considerations

This section provides information on power dissipation and junction temperature for the IDT8N4SV75. Equations and example calculations are also provided.

1. Power Dissipation.

The total power dissipation for the IDT8N4SV75 is the sum of the core power plus the analog power plus the power dissipated due to the load. The following is the power dissipation for $V_{CC} = 3.3V + 5\% = 3.465V$, which gives worst case results.

- Power_{MAX} = $V_{CC_MAX} * I_{CC_MAX} = 3.465V * 175mA = 606mW$

2. Junction Temperature.

Junction temperature, T_j , is the temperature at the junction of the bond wire and bond pad directly affects the reliability of the device. The maximum recommended junction temperature is 125°C. Limiting the internal transistor junction temperature, T_j , to 125°C ensures that the bond wire and bond pad temperature remains below 125°C.

The equation for T_j is as follows: $T_j = \theta_{JA} * Pd_total + T_A$

T_j = Junction Temperature

θ_{JA} = Junction-to-Ambient Thermal Resistance

Pd_total = Total Device Power Dissipation (example calculation is in section 1 above)

T_A = Ambient Temperature

In order to calculate junction temperature, the appropriate junction-to-ambient thermal resistance θ_{JA} must be used. Assuming no air flow and a multi-layer board, the appropriate value is 49.4°C/W per Table 6 below.

Therefore, T_j for an ambient temperature of 85°C with all outputs switching is:

$$85^\circ C + 0.606mW * 49.4^\circ C/W = 114.9^\circ C. \text{ This is below the limit of } 125^\circ C.$$

This calculation is only an example. T_j will obviously vary depending on the number of loaded outputs, supply voltage, air flow and the type of board (multi-layer).

Table 6. Thermal Resistance θ_{JA} for a 6-Lead Ceramic 5mm x 7mm Package, Forced Convection

θ_{JA} by Velocity			
Meters per Second	0	1	2
Multi-Layer PCB, JEDEC Standard Test Boards	49.4°C/W	44.2°C/W	42.1°C/W

Reliability Information

Table 7. θ_{JA} vs. Air Flow Table for a 6-Lead Ceramic 5mm x 7mm Package

θ_{JA} vs. Air Flow			
Meters per Second	0	1	2
Multi-Layer PCB, JEDEC Standard Test Boards	49.4°C/W	44.2°C/W	42.1°C/W

Transistor Count

The transistor count for IDT8N4SV75 is: 47,414

Package Outline and Package Dimensions



Ordering Information for FemtoClock NG Ceramic-Package XO and VCXO Products

The programmable VCXO and XO devices support a variety of device options such as the output type, number of default frequencies, internal crystal frequency, power supply voltage, ambient temperature range and the frequency accuracy. The device options, default frequencies and default VCXO pull range must be specified at the time of order and are programmed by IDT before the shipment. The table below specifies the available order codes, including the device options and default frequency configurations. Example part number: the order code 8N3QV01FG-0001CDI specifies a programmable, quad default-frequency VCXO with a voltage supply of 2.5V, a LVPECL output, a ±50 ppm crystal frequency accuracy,

contains a 114.285MHz internal crystal as frequency source, industrial temperature range, a lead-free (6/6 RoHS) 6-lead ceramic 5mm x 7mm x 1.55mm package and is factory-programmed to the default frequencies of 100MHz, 122.88MHz, 125MHz and 156.25MHz and to the VCXO pull range of min. ±100 ppm.

Other default frequencies and order codes are available from IDT on request. For more information on available default frequencies, see the *FemtoClock NG Ceramic-Package XO and VCXO Ordering Product Information* document.



NOTE: For order information, also see the *FemtoClock NG Ceramic-Package XO and VCXO Ordering Product Information* document.

Device Marking

Table 8. Device Marking

Marking	Industrial Temperature Range ($T_A = -40^{\circ}\text{C}$ to 85°C)	Commercial Temperature Range ($T_A = 0^{\circ}\text{C}$ to 70°C)
		IDT8N4SV75yC- ddddCDI
y = Option Code, dddd =Default-Frequency and VCXO Pull Range		

Revision History Sheet

Rev	Table	Page	Description of Change	Date
A	T7	4 13 14	Absolute Maximum Ratings - Thermal Impedance changed from 41.4 to 41.9. Power Considerations - corrected Thermal Resistance table and updated calculations. Reliability Information - corrected thermal table.	4/25/12
B	T4D T4E	5 5 15	3.3V LVDS DC Characteristics Table - updated specs. 2.5V LVDS DC Characteristics Table - updated specs. Corrected Package Information. Per PCN #N1206-02.	8/22/12
B	T5A	6 15	AC Characteristics Table - RMS Phase Jitter parameter change test conditions of: 500MHz $\leq f_{out} \leq$ 1300MHz to 500MHz $< f_{out} \leq$ 1300MHz; and 100MHz $\leq f_{out} \leq$ 500MHz to 100MHz $< f_{out} \leq$ 500MHz Corrected Package Outline & Dimensions drawing.	11/6/13

We've Got Your Timing Solution



6024 Silver Creek Valley Road
San Jose, California 95138

Sales

800-345-7015 (inside USA)
+408-284-8200 (outside USA)
Fax: 408-284-2775
www.IDT.com/go/contactIDT

Technical Support

netcom@idt.com
+480-763-2056

DISCLAIMER Integrated Device Technology, Inc. (IDT) and its subsidiaries reserve the right to modify the products and/or specifications described herein at any time and at IDT's sole discretion. All information in this document, including descriptions of product features and performance, is subject to change without notice. Performance specifications and the operating parameters of the described products are determined in the independent state and are not guaranteed to perform the same way when installed in customer products. The information contained herein is provided without representation or warranty of any kind, whether express or implied, including, but not limited to, the suitability of IDT's products for any particular purpose, an implied warranty of merchantability, or non-infringement of the intellectual property rights of others. This document is presented only as a guide and does not convey any license under intellectual property rights of IDT or any third parties.

IDT's products are not intended for use in application involving extreme environmental conditions or in life support systems or similar devices where the failure or malfunction of an IDT product can be reasonably expected to significantly affect the health or safety of users. Anyone using an IDT product in such a manner does so at their own risk, absent an express, written agreement by IDT.

Integrated Device Technology, IDT and the IDT logo are registered trademarks of IDT. Other trademarks and service marks used herein, including protected names, logos and designs, are the property of IDT or their respective third party owners.

Copyright 2013. All rights reserved.



Компания «ЭлектроПласт» предлагает заключение долгосрочных отношений при поставках импортных электронных компонентов на взаимовыгодных условиях!

Наши преимущества:

- Оперативные поставки широкого спектра электронных компонентов отечественного и импортного производства напрямую от производителей и с крупнейших мировых складов;
- Поставка более 17-ти миллионов наименований электронных компонентов;
- Поставка сложных, дефицитных, либо снятых с производства позиций;
- Оперативные сроки поставки под заказ (от 5 рабочих дней);
- Экспресс доставка в любую точку России;
- Техническая поддержка проекта, помощь в подборе аналогов, поставка прототипов;
- Система менеджмента качества сертифицирована по Международному стандарту ISO 9001;
- Лицензия ФСБ на осуществление работ с использованием сведений, составляющих государственную тайну;
- Поставка специализированных компонентов (Xilinx, Altera, Analog Devices, Intersil, Interpoint, Microsemi, Aeroflex, Peregrine, Syfer, Eurofarad, Texas Instrument, Miteq, Cobham, E2V, MA-COM, Hittite, Mini-Circuits, General Dynamics и др.);

Помимо этого, одним из направлений компании «ЭлектроПласт» является направление «Источники питания». Мы предлагаем Вам помощь Конструкторского отдела:

- Подбор оптимального решения, техническое обоснование при выборе компонента;
- Подбор аналогов;
- Консультации по применению компонента;
- Поставка образцов и прототипов;
- Техническая поддержка проекта;
- Защита от снятия компонента с производства.



Как с нами связаться

Телефон: 8 (812) 309 58 32 (многоканальный)

Факс: 8 (812) 320-02-42

Электронная почта: org@eplast1.ru

Адрес: 198099, г. Санкт-Петербург, ул. Калинина, дом 2, корпус 4, литера А.