

Ambient Light Sensor



20118

DESCRIPTION

TEPT5700 ambient light sensor is a silicon NPN epitaxial planar phototransistor in a T-1 $\frac{3}{4}$ package. It is sensitive to visible light much like the human eye and has peak sensitivity at 570 nm.

FEATURES

- Package type: leaded
- Package form: T-1 $\frac{3}{4}$
- Dimensions (in mm): \varnothing 5
- High photo sensitivity
- Adapted to human eye responsivity
- Angle of half sensitivity: $\varphi = \pm 50^\circ$
- Compliant to RoHS Directive 2002/95/EC and in accordance to WEEE 2002/96/EC



Note

- ** Please see document "Vishay Material Category Policy": www.vishay.com/doc?99902

APPLICATIONS

- Ambient light sensor for control of display backlight dimming in LCD displays and keypad backlighting of mobile devices and in industrial on/off-lighting operation

PRODUCT SUMMARY			
COMPONENT	I_{PCE} (mA)	φ (deg)	$\lambda_{0.5}$ (nm)
TEPT5700	75	± 50	440 to 800

Note

- Test condition see table "Basic Characteristics"

ORDERING INFORMATION			
ORDERING CODE	PACKAGING	REMARKS	PACKAGE FORM
TEPT5700	Bulk	MOQ: 4000 pcs, 4000 pcs/bulk. Label with I_{PCE} group on each bulk. Specifications of group A/B/C see table "Type Dedicated Characteristics" on page 2	T-1 $\frac{3}{4}$

Note

- MOQ: minimum order quantity

ABSOLUTE MAXIMUM RATINGS ($T_{amb} = 25^\circ\text{C}$, unless otherwise specified)				
PARAMETER	TEST CONDITION	SYMBOL	VALUE	UNIT
Collector emitter voltage		V_{CEO}	6	V
Emitter collector voltage		V_{ECO}	1.5	V
Collector current		I_C	20	mA
Power dissipation	$T_{amb} \leq 55^\circ\text{C}$	P_V	100	mW
Junction temperature		T_j	100	$^\circ\text{C}$
Operating temperature range		T_{amb}	- 40 to + 85	$^\circ\text{C}$
Storage temperature range		T_{stg}	- 40 to + 100	$^\circ\text{C}$
Soldering temperature	$t \leq 5$ s, 2 mm distance to package	T_{sd}	260	$^\circ\text{C}$
Thermal resistance junction/ambient	J-STD-051, soldered on PCB	R_{thJA}	230	K/W

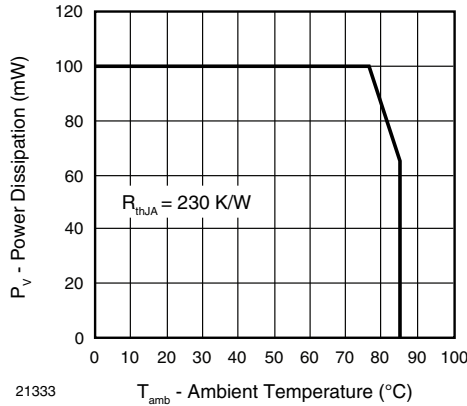

Fig. 1 - Power Dissipation Limit vs. Ambient Temperature

BASIC CHARACTERISTICS ($T_{amb} = 25\text{ }^{\circ}\text{C}$, unless otherwise specified)						
PARAMETER	TEST CONDITION	SYMBOL	MIN.	TYP.	MAX.	UNIT
Collector emitter breakdown voltage	$I_C = 0.1\text{ mA}$	V_{CE0}	6			V
Collector dark current	$V_{CE} = 5\text{ V}, E = 0$	I_{CEO}		3	50	nA
Collector emitter capacitance	$V_{CE} = 0\text{ V}, f = 1\text{ MHz}, E = 0$	C_{CEO}		16		pF
Collector light current	$E_v = 20\text{ lx}, \text{CIE illuminant A}, V_{CE} = 5\text{ V}$	I_{PCE}	5.2		24	μA
	$E_v = 100\text{ lx}, \text{CIE illuminant A}, V_{CE} = 5\text{ V}$	I_{PCE}		75		μA
Angle of half sensitivity		ϕ		± 50		deg
Wavelength of peak sensitivity		λ_p		570		nm
Range of spectral bandwidth		$\lambda_{0.5}$		440 to 800		nm
Collector emitter saturation voltage	$E_v = 20\text{ lx}, \text{CIE illuminant A}, I_{PCE} = 1.2\text{ }\mu\text{A}$	V_{CEsat}		0.1		V

TYPE DEDICATED CHARACTERISTICS						
PARAMETER	TEST CONDITION	BINNED GROUP	SYMBOL	MIN.	MAX.	UNIT
Photo current	$E_v = 20\text{ lx}, \text{CIE illuminant A}, V_{CE} = 5\text{ V}, T_{amb} = 25\text{ }^{\circ}\text{C}$	A	I_{PCE}	5.2	9.9	μA
		B	I_{PCE}	8.2	15.4	μA
		C	I_{PCE}	12.7	24	μA

Note

- Each 4000 piece bag will contain a single group. The label on the bag will indicate which binned group is in the bag. A specific group cannot be ordered. Production shipments containing multiple bags will likely include multiple groups. Please design accordingly.

BASIC CHARACTERISTICS ($T_{amb} = 25\text{ }^{\circ}\text{C}$, unless otherwise specified)

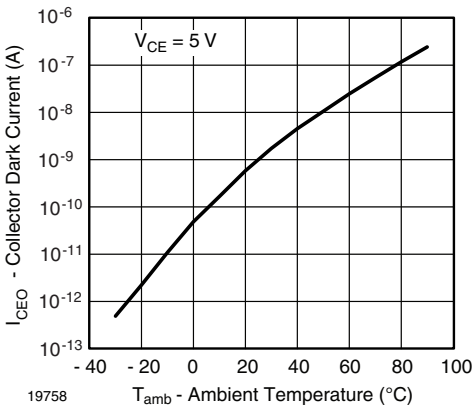

Fig. 1 - Collector Dark Current vs. Ambient Temperature

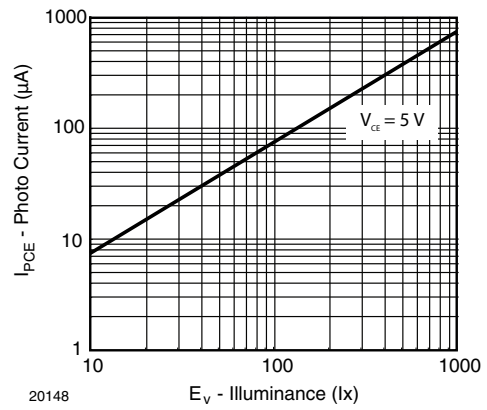

Fig. 4 - Photo Current vs. Illuminance

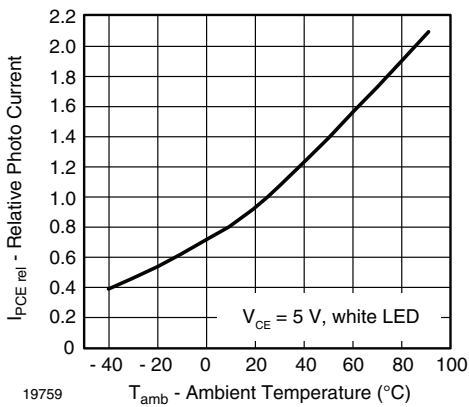

Fig. 2 - Relative Photo Current vs. Ambient Temperature

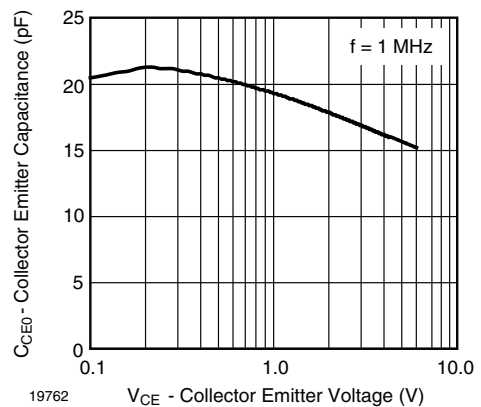

Fig. 5 - Collector Emitter Capacitance vs. Collector Emitter Voltage

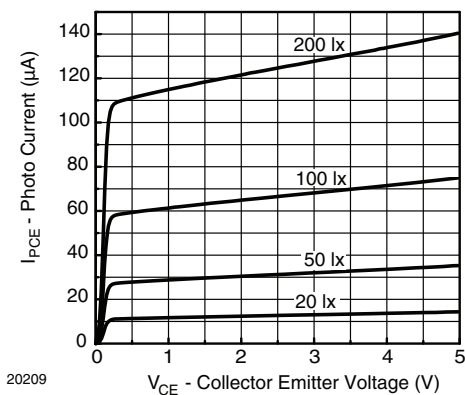

Fig. 3 - Photo Current vs. Collector Emitter Voltage

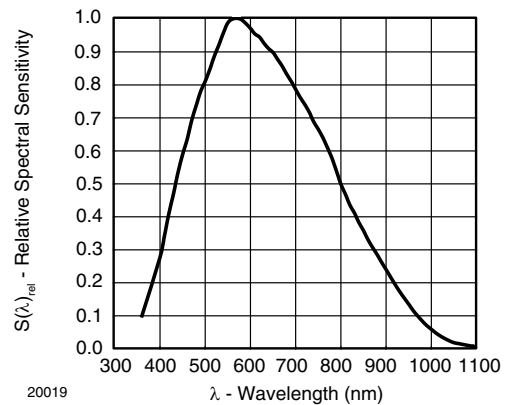

Fig. 6 - Relative Spectral Sensitivity vs. Wavelength

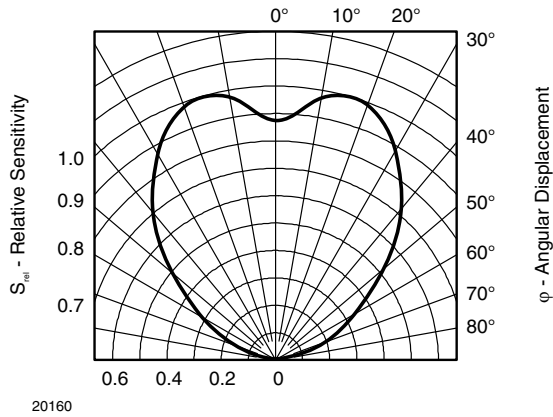
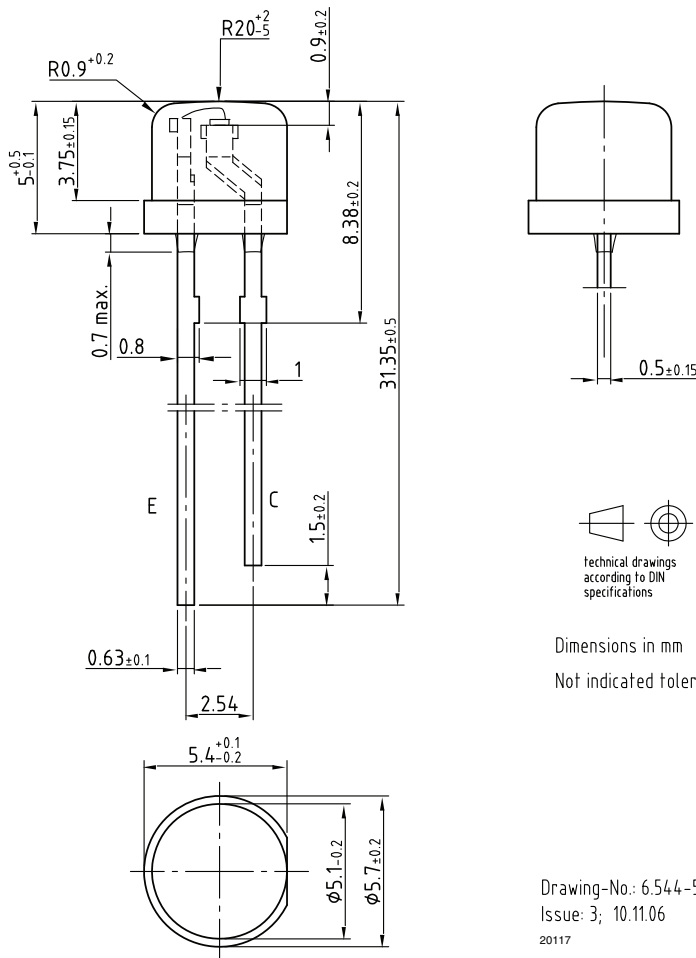

Fig. 7 - Relative Radiant Sensitivity vs. Angular Displacement

PACKAGE DIMENSIONS in millimeters



Drawing-No.: 6.544-5375.01-4
 Issue: 3; 10.11.06
 20117



Disclaimer

ALL PRODUCT, PRODUCT SPECIFICATIONS AND DATA ARE SUBJECT TO CHANGE WITHOUT NOTICE TO IMPROVE RELIABILITY, FUNCTION OR DESIGN OR OTHERWISE.

Vishay Intertechnology, Inc., its affiliates, agents, and employees, and all persons acting on its or their behalf (collectively, "Vishay"), disclaim any and all liability for any errors, inaccuracies or incompleteness contained in any datasheet or in any other disclosure relating to any product.

Vishay makes no warranty, representation or guarantee regarding the suitability of the products for any particular purpose or the continuing production of any product. To the maximum extent permitted by applicable law, Vishay disclaims (i) any and all liability arising out of the application or use of any product, (ii) any and all liability, including without limitation special, consequential or incidental damages, and (iii) any and all implied warranties, including warranties of fitness for particular purpose, non-infringement and merchantability.

Statements regarding the suitability of products for certain types of applications are based on Vishay's knowledge of typical requirements that are often placed on Vishay products in generic applications. Such statements are not binding statements about the suitability of products for a particular application. It is the customer's responsibility to validate that a particular product with the properties described in the product specification is suitable for use in a particular application. Parameters provided in datasheets and/or specifications may vary in different applications and performance may vary over time. All operating parameters, including typical parameters, must be validated for each customer application by the customer's technical experts. Product specifications do not expand or otherwise modify Vishay's terms and conditions of purchase, including but not limited to the warranty expressed therein.

Except as expressly indicated in writing, Vishay products are not designed for use in medical, life-saving, or life-sustaining applications or for any other application in which the failure of the Vishay product could result in personal injury or death. Customers using or selling Vishay products not expressly indicated for use in such applications do so at their own risk. Please contact authorized Vishay personnel to obtain written terms and conditions regarding products designed for such applications.

No license, express or implied, by estoppel or otherwise, to any intellectual property rights is granted by this document or by any conduct of Vishay. Product names and markings noted herein may be trademarks of their respective owners.

Material Category Policy

Vishay Intertechnology, Inc. hereby certifies that all its products that are identified as RoHS-Compliant fulfill the definitions and restrictions defined under Directive 2011/65/EU of The European Parliament and of the Council of June 8, 2011 on the restriction of the use of certain hazardous substances in electrical and electronic equipment (EEE) - recast, unless otherwise specified as non-compliant.

Please note that some Vishay documentation may still make reference to RoHS Directive 2002/95/EC. We confirm that all the products identified as being compliant to Directive 2002/95/EC conform to Directive 2011/65/EU.

Vishay Intertechnology, Inc. hereby certifies that all its products that are identified as Halogen-Free follow Halogen-Free requirements as per JEDEC JS709A standards. Please note that some Vishay documentation may still make reference to the IEC 61249-2-21 definition. We confirm that all the products identified as being compliant to IEC 61249-2-21 conform to JEDEC JS709A standards.



Компания «ЭлектроПласт» предлагает заключение долгосрочных отношений при поставках импортных электронных компонентов на взаимовыгодных условиях!

Наши преимущества:

- Оперативные поставки широкого спектра электронных компонентов отечественного и импортного производства напрямую от производителей и с крупнейших мировых складов;
- Поставка более 17-ти миллионов наименований электронных компонентов;
- Поставка сложных, дефицитных, либо снятых с производства позиций;
- Оперативные сроки поставки под заказ (от 5 рабочих дней);
- Экспресс доставка в любую точку России;
- Техническая поддержка проекта, помощь в подборе аналогов, поставка прототипов;
- Система менеджмента качества сертифицирована по Международному стандарту ISO 9001;
- Лицензия ФСБ на осуществление работ с использованием сведений, составляющих государственную тайну;
- Поставка специализированных компонентов (Xilinx, Altera, Analog Devices, Intersil, Interpoint, Microsemi, Aeroflex, Peregrine, Syfer, Eurofarad, Texas Instrument, Miteq, Cobham, E2V, MA-COM, Hittite, Mini-Circuits, General Dynamics и др.);

Помимо этого, одним из направлений компании «ЭлектроПласт» является направление «Источники питания». Мы предлагаем Вам помощь Конструкторского отдела:

- Подбор оптимального решения, техническое обоснование при выборе компонента;
- Подбор аналогов;
- Консультации по применению компонента;
- Поставка образцов и прототипов;
- Техническая поддержка проекта;
- Защита от снятия компонента с производства.



Как с нами связаться

Телефон: 8 (812) 309 58 32 (многоканальный)

Факс: 8 (812) 320-02-42

Электронная почта: org@eplast1.ru

Адрес: 198099, г. Санкт-Петербург, ул. Калинина, дом 2, корпус 4, литера А.