

# Cree® XLamp® CXB1820 LED



## PRODUCT DESCRIPTION

The XLamp® CXB1820 LED Array is a member of the second generation of the CXA family that delivers up to 30% higher efficacy and up to 20% higher lumens than the first generation in the same LES. The higher performance second generation CXA LED Arrays provide a drop-in performance upgrade to existing CXA LED designs to shorten product development time. In addition, the CXB LEDs also allow lighting manufacturers to achieve the same or better performance with a smaller LES, enabling a smaller, more impactful luminaire. Available in 2-step, 3-step and 5-step EasyWhite® bins, the CXB1820 LED delivers high lumen output and high efficacy in a single, easy-to-use package that eliminates the need for reflow soldering.

The [CX Family LED Design Guide](#) provides basic information on the requirements to use the CXB1820 LED successfully in luminaire designs.

## FEATURES

- 12-mm optical source
- Mechanical and optical design consistent with other CXA18 and CXB18 LEDs with a 12-mm optical source
- Available in 70-, 80- and 90-minimum CRI options
- Cree EasyWhite® 2-, 3- and 5-step binning
- Forward voltage option: 36-V class
- 85 °C binning and characterization
- Extremely uniform color over viewing angle
- Top-side solder connections
- Thermocouple attach point
- NEMA SSL-3 2011 standard flux bins
- RoHS-compliant
- UL® recognized component (E349212)

## TABLE OF CONTENTS

Characteristics .....	2
Operating Limits.....	2
Flux Characteristics, EasyWhite®	
Order Codes and Bins .....	3
Relative Spectral Power Distribution .....	5
Electrical Characteristics.....	5
Relative Luminous Flux.....	6
Typical Spatial Distribution.....	7
Performance Groups - Brightness .....	7
Performance Groups - Chromaticity.....	8
Cree EasyWhite® Bins Plotted on the 1931 CIE Curve .....	9
Bin and Order Code Formats .....	10
Mechanical Dimensions .....	10
Thermal Design .....	11
Notes .....	12
Packaging .....	13



**CHARACTERISTICS**

Characteristics	Unit	Minimum	Typical	Maximum
Viewing angle (FWHM)	degrees		115	
ESD withstand voltage (HBM per Mil-Std-883D)	V			8000
DC forward current	mA			1050*
Reverse current	mA			0.1
Forward voltage (@ 550 mA, 85 °C)	V		35	38

\* Refer to the Operating Limits section.

**OPERATING LIMITS**

The maximum current rating of the CXB1820 is dependent on the case temperature (Tc) when the LED has reached thermal equilibrium under steady-state operation. The graph shown below assumes that the system design employs good thermal management (thermal interface material and heat sink) and may vary when poor thermal management is employed. Please refer to the Mechanical Dimensions section on page 10 for the location of the Tc measurement point.

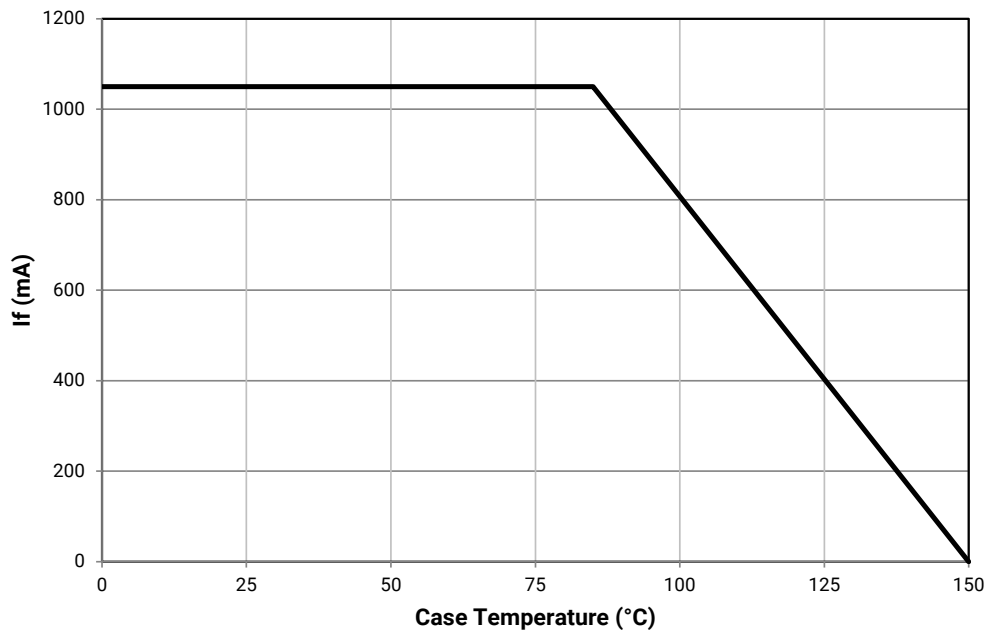

**FLUX CHARACTERISTICS, EASYWHITE® ORDER CODES AND BINS ( $I_F = 550 \text{ mA}$ ,  $T_J = 85 \text{ °C}$ )**

The following table provides order codes for XLamp CXB1820 LEDs. For a complete description of the order code nomenclature, please see the Bin and Order Code Formats section (page 10).

Nominal CCT	CRI*		Minimum Luminous Flux			2-Step		3-Step		5-Step	
	Min	Typ	Group	Flux (lm) @ 85 °C	Flux (lm) @ 25 °C**	Group	Order Code	Group	Order Code	Group	Order Code
6500 K	70	---	S2	2780	3050					65E	CXB1820-0000-000N0BS265E
			S4	2990	3280				CXB1820-0000-000N0BS465E		
	80	---	S2	2780	3050					65E	CXB1820-0000-000N0HS265E
			S4	2990	3280				CXB1820-0000-000N0HS465E		
5700 K	70	---	S2	2780	3050					57E	CXB1820-0000-000N0BS257E
			S4	2990	3280				CXB1820-0000-000N0BS457E		
	80	---	S2	2780	3050					57E	CXB1820-0000-000N0HS257E
			S4	2990	3280				CXB1820-0000-000N0HS457E		
5000 K	70	---	S2	2780	3050					50E	CXB1820-0000-000N0BS250E
			S4	2990	3280				CXB1820-0000-000N0BS450E		
	80	---	S2	2780	3050			50G	CXB1820-0000-000N0HS250G	50E	CXB1820-0000-000N0HS250E
			S4	2990	3280				CXB1820-0000-000N0HS450G		CXB1820-0000-000N0HS450E
	90	92	R2	2420	2655			50G	CXB1820-0000-000N0UR250G		
			R4	2600	2852				CXB1820-0000-000N0UR450G		
4000 K	70	---	S2	2780	3050					40E	CXB1820-0000-000N0BS240E
			S4	2990	3280				CXB1820-0000-000N0BS440E		
	80	---	R4	2600	2852		40H	CXB1820-0000-000N0HR440H	40G	CXB1820-0000-000N0HR440G	
			S2	2780	3050					CXB1820-0000-000N0HS240G	
	90	92	Q4	2260	2479		40H	CXB1820-0000-000N0UQ440H	40G	CXB1820-0000-000N0UQ440G	
			R2	2420	2655					CXB1820-0000-000N0UR240H	CXB1820-0000-000N0UR240G

- Notes**
- Cree maintains a tolerance of  $\pm 7\%$  on flux and power measurements,  $\pm 0.005$  on chromaticity (CCx, CCy) measurements and a tolerance of  $\pm 2$  on CRI measurements. See the Measurements section (page 12).
  - Cree XLamp CXB1820 LED order codes specify only a minimum flux bin and not a maximum. Cree may ship reels in flux bins higher than the minimum specified by the order code without advance notice. Shipments will always adhere to the chromaticity bin restrictions specified by the order code.
  - \* For 80 CRI minimum LEDs, CRI R9 minimum is 0 with a  $\pm 2$  tolerance. For 90 CRI minimum LEDs, CRI R9 typical is 60.
  - \*\* Flux values @ 25 °C are calculated and for reference only.

**FLUX CHARACTERISTICS, EASYWHITE® ORDER CODES AND BINS ( $I_F = 550 \text{ mA}$ ,  $T_J = 85 \text{ °C}$ ) - CONTINUED**

Nominal CCT	CRI*		Minimum Luminous Flux			2-Step		3-Step		5-Step	
	Min	Typ	Group	Flux (lm) @ 85 °C	Flux (lm) @ 25 °C**	Group	Order Code	Group	Order Code	Group	Order Code
3500 K	80	---	R4	2600	2852	35H	CXB1820-0000-000N0HR435H	35G	CXB1820-0000-000N0HR435G		
			S2	2780	3050		CXB1820-0000-000N0HS235H		CXB1820-0000-000N0HS235G		
	90	92	Q4	2260	2479	35H	CXB1820-0000-000N0UQ435H	35G	CXB1820-0000-000N0UQ435G		
			R2	2420	2655		CXB1820-0000-000N0UR235H		CXB1820-0000-000N0UR235G		
3000 K	80	---	R2	2420	2655	30H	CXB1820-0000-000N0HR230H	30G	CXB1820-0000-000N0HR230G		
			R4	2600	2852		CXB1820-0000-000N0HR430H		CXB1820-0000-000N0HR430G		
	90	92	Q2	2100	2304	30H	CXB1820-0000-000N0UQ230H	30G	CXB1820-0000-000N0UQ230G		
			Q4	2260	2479		CXB1820-0000-000N0UQ430H		CXB1820-0000-000N0UQ430G		
2700 K	80	---	R2	2420	2655	27H	CXB1820-0000-000N0HR227H	27G	CXB1820-0000-000N0HR227G		
			R4	2600	2852		CXB1820-0000-000N0HR427H		CXB1820-0000-000N0HR427G		
	90	92	P4	1965	2156	27H	CXB1820-0000-000N0UP427H	27G	CXB1820-0000-000N0UP427G		
			Q2	2100	2304		CXB1820-0000-000N0UQ227H		CXB1820-0000-000N0UQ227G		

**Notes**

- Cree maintains a tolerance of  $\pm 7\%$  on flux and power measurements,  $\pm 0.005$  on chromaticity (CCx, CCy) measurements and a tolerance of  $\pm 2$  on CRI measurements. See the Measurements section (page 12).
- Cree XLamp CXB1820 LED order codes specify only a minimum flux bin and not a maximum. Cree may ship reels in flux bins higher than the minimum specified by the order code without advance notice. Shipments will always adhere to the chromaticity bin restrictions specified by the order code.
- \* For 80 CRI minimum LEDs, CRI R9 minimum is 0 with a  $\pm 2$  tolerance. For 90 CRI minimum LEDs, CRI R9 typical is 60.
- \*\* Flux values @ 25 °C are calculated and for reference only.

**RELATIVE SPECTRAL POWER DISTRIBUTION**

The following graph is the result of a series of pulsed measurements at 550 mA and  $T_j = 85^\circ\text{C}$ .

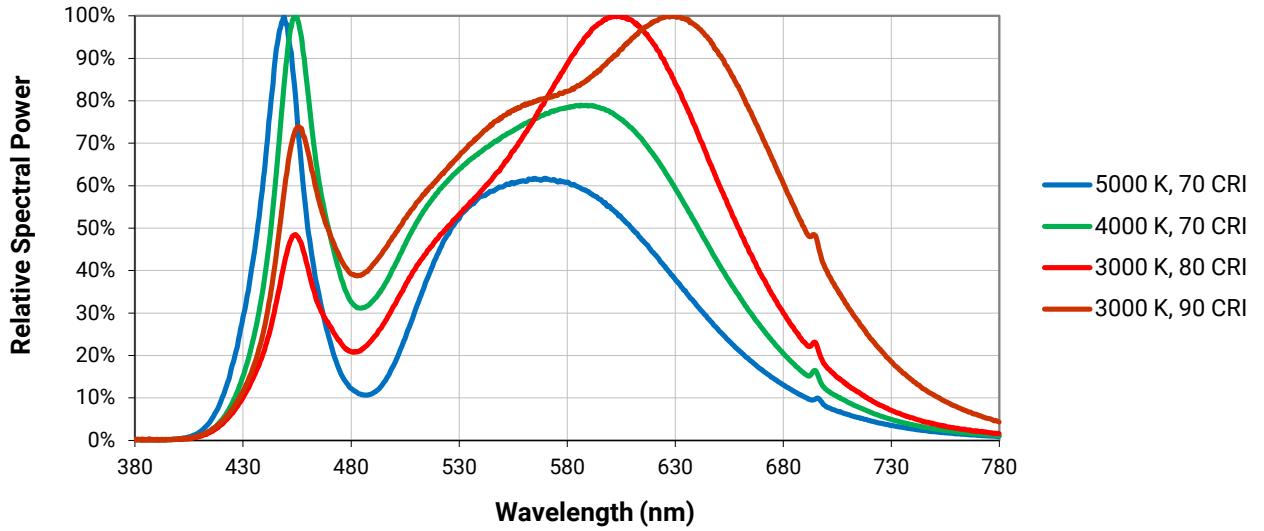

**ELECTRICAL CHARACTERISTICS**

The following graph is the result of a series of steady-state measurements.

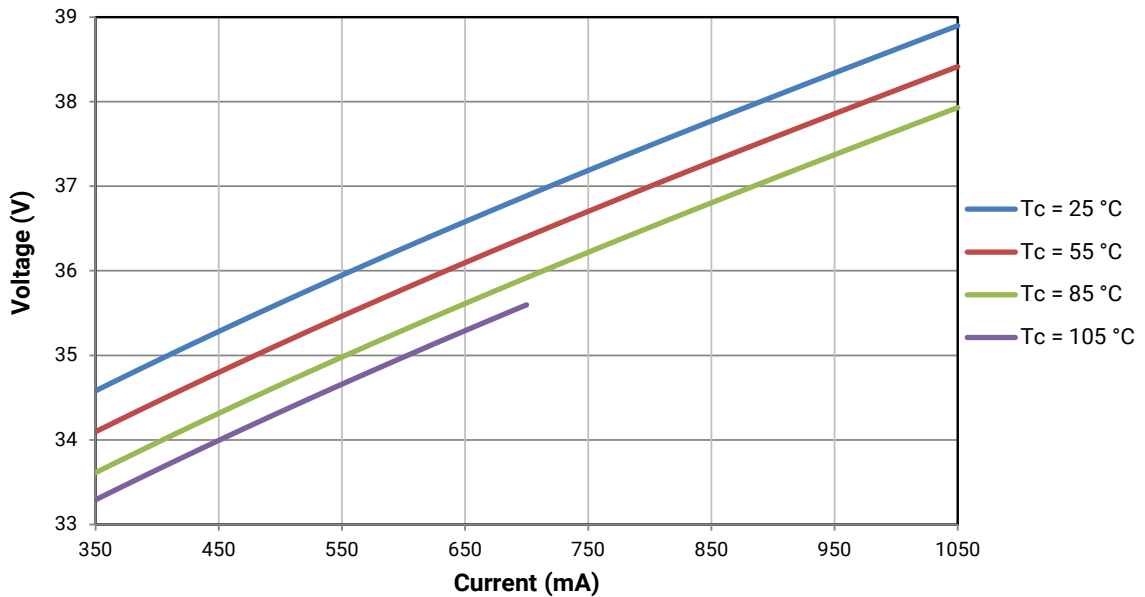

**RELATIVE LUMINOUS FLUX**

The relative luminous flux values provided below are the ratio of measurements of the CXB1820 LED at steady-state operation at the given conditions, divided by the flux measured during binning, which is a pulsed measurement at 550 mA at  $T_j = 85^\circ\text{C}$ .

For example, at steady-state operation of  $T_c = 55^\circ\text{C}$ ,  $I_f = 650\text{ mA}$ , the relative luminous flux ratio is 120% in the chart below. A CXB1820 LED that measures 2100 lm during binning will deliver 2520 lm ( $2100 \times 1.2$ ) at steady-state operation of  $T_c = 55^\circ\text{C}$ ,  $I_f = 650\text{ mA}$ .

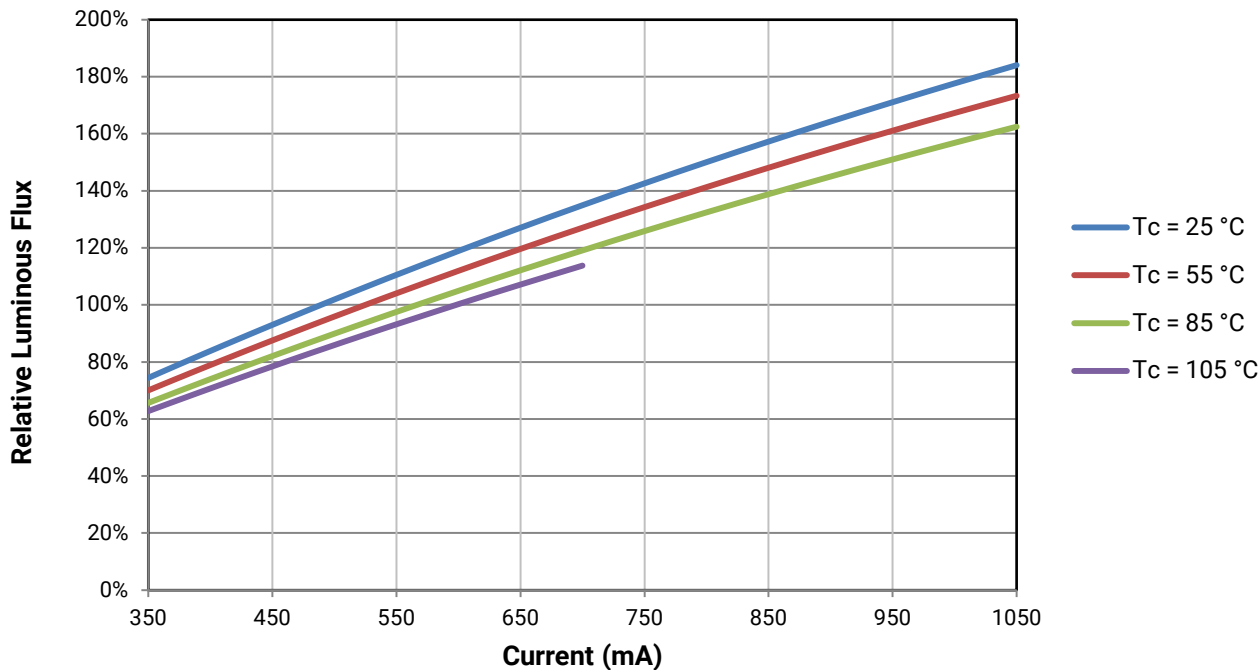

**TYPICAL SPATIAL DISTRIBUTION**

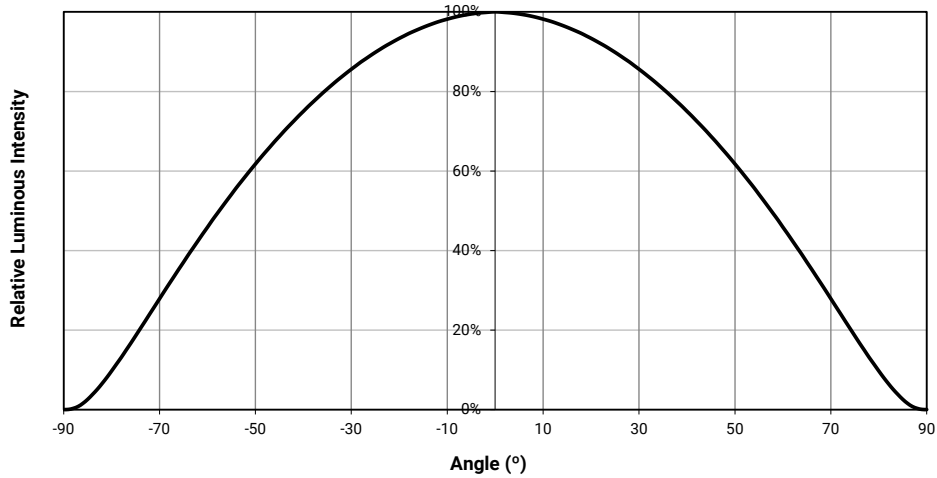

**PERFORMANCE GROUPS - BRIGHTNESS ( $I_F = 550 \text{ mA}$ ,  $T_J = 85 \text{ °C}$ )**

XLamp CXB1820 LEDs are tested for luminous flux and placed into one of the following bins.

Group Code	Min. Luminous Flux	Max. Luminous Flux
P4	1965	2100
Q2	2100	2260
Q4	2260	2420
R2	2420	2600
R4	2600	2780
S2	2780	2990
S4	2990	3200
T2	3200	3440

**PERFORMANCE GROUPS - CHROMATICITY ( $T_j = 85\text{ °C}$ )**

XLamp CXB1820 LEDs are tested for chromaticity and placed into one of the regions defined by the following bounding coordinates.

EasyWhite Color Temperatures – 2-Step			
Code	CCT	x	y
40H	4000 K	0.3777	0.3739
		0.3797	0.3816
		0.3861	0.3855
		0.3838	0.3777
35H	3500 K	0.4022	0.3858
		0.4053	0.3942
		0.4125	0.3977
		0.4091	0.3891
30H	3000 K	0.4287	0.3975
		0.4328	0.4064
		0.4390	0.4086
		0.4347	0.3996
27H	2700 K	0.4524	0.4048
		0.4574	0.4140
		0.4633	0.4154
		0.4581	0.4062

EasyWhite Color Temperatures – 3-Step Ellipse						
Bin Code	CCT	Center Point		Major Axis	Minor Axis	Rotation Angle (°)
		x	y	a	b	
50G	5000 K	0.3447	0.3553	0.00840	0.00312	65.0
40G	4000 K	0.3818	0.3797	0.00939	0.00402	53.7
35G	3500 K	0.4073	0.3917	0.00927	0.00414	54.0
30G	3000 K	0.4338	0.4030	0.00834	0.00408	53.2
27G	2700 K	0.4577	0.4099	0.00834	0.00420	48.5

EasyWhite Color Temperatures – 5-Step Ellipse						
Bin Code	CCT	Center Point		Major Axis	Minor Axis	Rotation Angle (°)
		x	y	a	b	
65E	6500 K	0.3123	0.3282	0.01110	0.00550	61.0
57E	5700 K	0.3287	0.3417	0.01230	0.00600	72.0
50E	5000 K	0.3447	0.3553	0.01400	0.00520	65.0
40E	4000 K	0.3818	0.3797	0.01565	0.00670	53.7



**CREE EASYWHITE® BINS PLOTTED ON THE 1931 CIE CURVE**

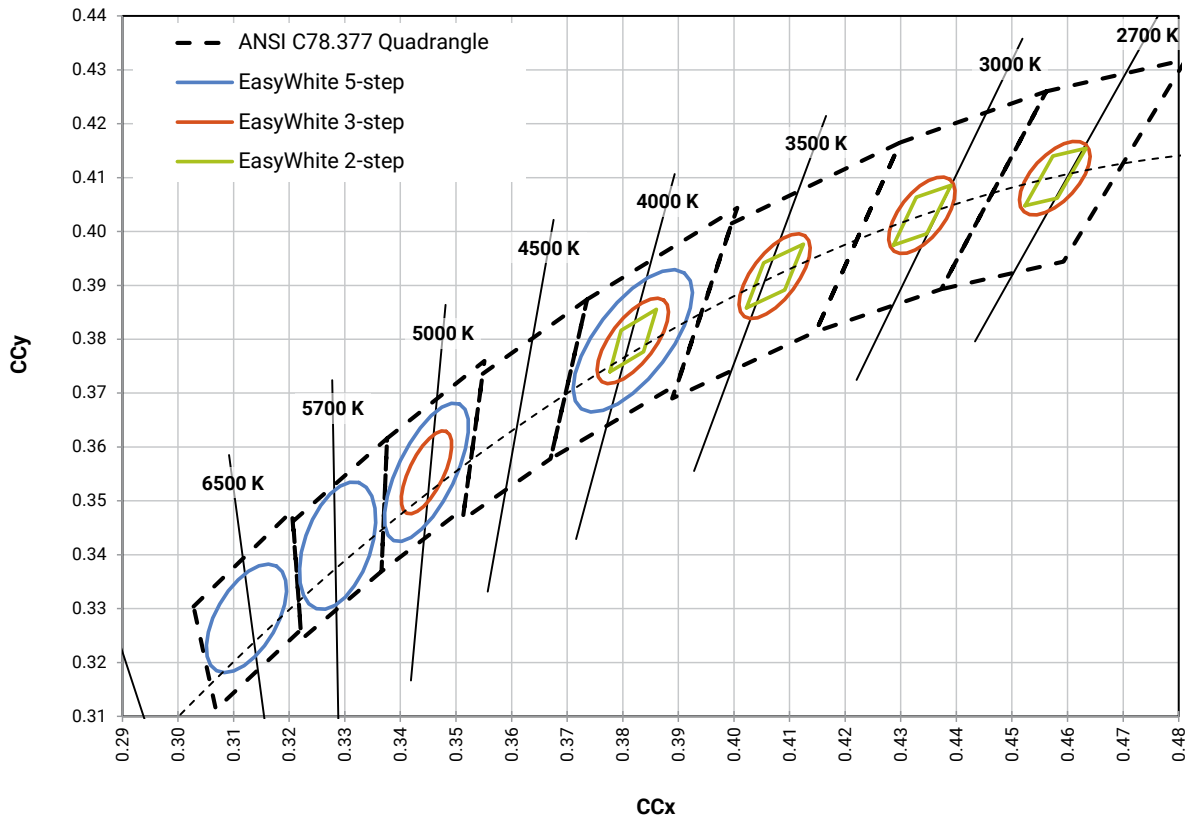



**THERMAL DESIGN**

The CXB family of LED arrays can include over a hundred different LED die inside one package, and thus over a hundred different junction temperatures ( $T_j$ ). Cree has intentionally removed junction-temperature-based operating limits and replaced the commonplace maximum  $T_j$  calculations with maximum ratings based on forward current ( $I_f$ ) and case temperature ( $T_c$ ). No additional calculations are required to ensure the CXB LED is being operated within its designed limits. Please refer to page 2 for the Operating Limit specification.

There is no need to calculate for  $T_j$  inside the package, as the thermal management design process, specifically from solder point ( $T_{sp}$ ) to ambient ( $T_a$ ), remains identical to any other LED component. For more information on thermal management of Cree XLamp LEDs, please refer to the [Thermal Management application note](#). For CXB soldering recommendations and more information on thermal interface materials (TIM) and connection methods, please refer to the [Cree XLamp CX Family LEDs soldering and handling document](#). The [CX Family LED Design Guide](#) provides basic information on the requirements to use Cree XLamp CXB LEDs successfully in luminaire designs.

To keep the CXB1820 LED at or below the maximum rated  $T_c$ , the case to ambient temperature thermal resistance ( $R_{c-a}$ ) must be at or below the maximum  $R_{c-a}$  value shown on the following graph, depending on the operating environment. The y-axis in the graph is a base 10 logarithmic scale.

As the figure at right shows, the  $R_{c-a}$  value is the sum of the thermal resistance of the TIM ( $R_{tim}$ ) plus the thermal resistance of the heat sink ( $R_{hs}$ ).

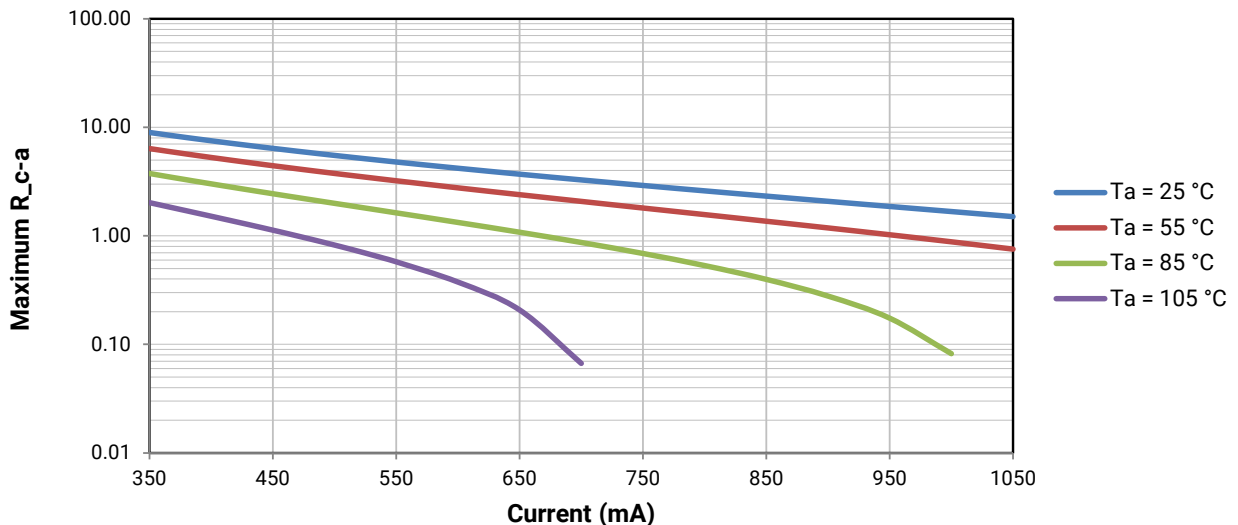
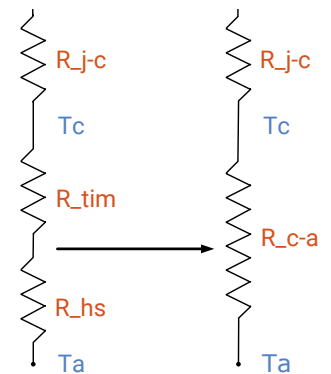

## NOTES

---

### Measurements

The luminous flux, radiant power, chromaticity and CRI measurements in this document are binning specifications only and solely represent product measurements as of the date of shipment. These measurements will change over time based on a number of factors that are not within Cree's control and are not intended or provided as operational specifications for the products. Calculated values are provided for informational purposes only and are not intended as specifications.

### Lumen Maintenance

Cree now uses standardized IES LM-80-08 and TM-21-11 methods for collecting long-term data and extrapolating LED lumen maintenance. For information on the specific LM-80 data sets available for this LED, refer to the public [LM-80 results document](#).

Please read the [Long-Term Lumen Maintenance application note](#) for more details on Cree's lumen maintenance testing and forecasting. Please read the [Thermal Management application note](#) for details on how thermal design, ambient temperature, and drive current affect the LED junction temperature.

### RoHS Compliance

The levels of RoHS restricted materials in this product are below the maximum concentration values (also referred to as the threshold limits) permitted for such substances, or are used in an exempted application, in accordance with EU Directive 2011/65/EC (RoHS2), as implemented January 2, 2013. RoHS Declarations for this product can be obtained from your Cree representative or from the Product Documentation sections of [www.cree.com](http://www.cree.com).

### UL® Recognized Component

Level 4 enclosure consideration. The LED package or a portion thereof has been investigated as a fire and electrical enclosure per ANSI/UL 8750.

### Vision Advisory

WARNING: Do not look at an exposed lamp in operation. Eye injury can result. For more information about LEDs and eye safety, please refer to the [LED Eye Safety application note](#).

**PACKAGING**

Cree CXB1820 LEDs are packaged in trays of 20. Five trays are sealed in an anti-static bag and placed inside a carton, for a total of 100 LEDs per carton. Each carton contains 100 LEDs from the same performance bin.

Dimensions are in inches.  
Tolerances:  $\pm .13$   
 $x^\circ \pm 1^\circ$

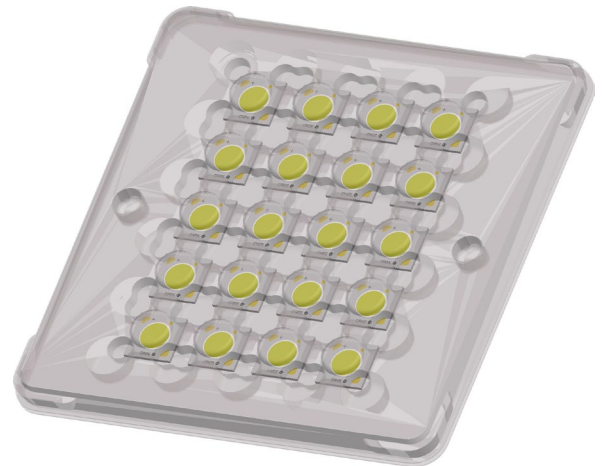
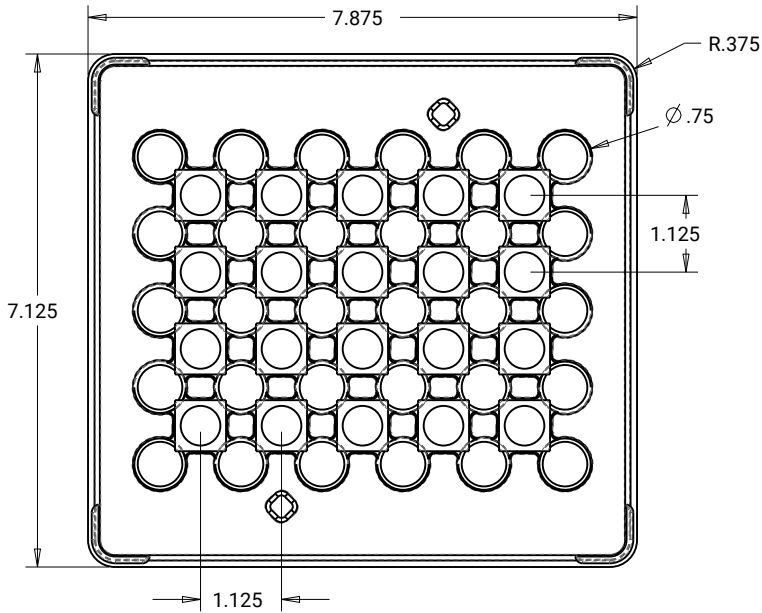

PATENT LABEL IS LOCATED ON UNDERSIDE OF CARTON

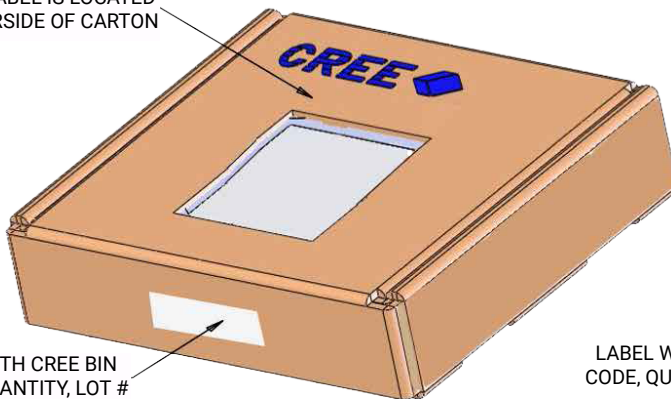

LABEL WITH CREE BIN CODE, QUANTITY, LOT #

BAG

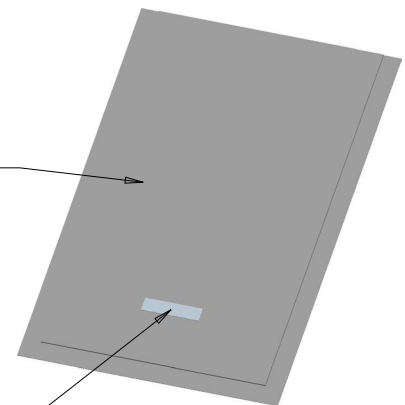

LABEL WITH CREE BIN CODE, QUANTITY, LOT #



Компания «ЭлектроПласт» предлагает заключение долгосрочных отношений при поставках импортных электронных компонентов на взаимовыгодных условиях!

Наши преимущества:

- Оперативные поставки широкого спектра электронных компонентов отечественного и импортного производства напрямую от производителей и с крупнейших мировых складов;
- Поставка более 17-ти миллионов наименований электронных компонентов;
- Поставка сложных, дефицитных, либо снятых с производства позиций;
- Оперативные сроки поставки под заказ (от 5 рабочих дней);
- Экспресс доставка в любую точку России;
- Техническая поддержка проекта, помощь в подборе аналогов, поставка прототипов;
- Система менеджмента качества сертифицирована по Международному стандарту ISO 9001;
- Лицензия ФСБ на осуществление работ с использованием сведений, составляющих государственную тайну;
- Поставка специализированных компонентов (Xilinx, Altera, Analog Devices, Intersil, Interpoint, Microsemi, Aeroflex, Peregrine, Syfer, Eurofarad, Texas Instrument, Miteq, Cobham, E2V, MA-COM, Hittite, Mini-Circuits, General Dynamics и др.);

Помимо этого, одним из направлений компании «ЭлектроПласт» является направление «Источники питания». Мы предлагаем Вам помощь Конструкторского отдела:

- Подбор оптимального решения, техническое обоснование при выборе компонента;
- Подбор аналогов;
- Консультации по применению компонента;
- Поставка образцов и прототипов;
- Техническая поддержка проекта;
- Защита от снятия компонента с производства.



#### Как с нами связаться

**Телефон:** 8 (812) 309 58 32 (многоканальный)

**Факс:** 8 (812) 320-02-42

**Электронная почта:** [org@eplast1.ru](mailto:org@eplast1.ru)

**Адрес:** 198099, г. Санкт-Петербург, ул. Калинина, дом 2, корпус 4, литера А.