

1M1-Series
Miniature Rocker &
Paddle Switch



1MS-Series
Sealed Miniature
Rocker & Paddle
Switch

Specifications

Contact Rating	refer to ordering scheme.
Electrical Life	1M1-Series: 50,000 make & break cycles @ full load 1MS-Series: 30,000 make & break cycles @ full load
Contact Resistance.	10 mΩ max. initial @ 2-4 VDC 100mA for both silver & gold plated contacts.
Insulation Resistance	1000 MΩ min.
Dielectric Strength	1500 Volts RMS @ sea level
Operating Temperature . . .	-30°C to +85°C
Index of Protection	1MS-Series: IP67
Solder Heat Resistance. . .	MIL-STD-202, Method 210
Actuator Travel	25°

Materials

Case	1M1-Series: Dially phthalate (DAP) (UL 94V-0) 1MS-Series: Glass filled nylon 6/6, flame retardant, heat stabilized (UL 94V-0)
Rocker/Paddle.	1M1-Series: Nylon (UL 94V-0) 1MS-Series: Nylon, black standard, internal o-ring sealed
Bushing	1M1-Series: Brass, nickel plated 1MS-Series: Glass filled nylon 6/6, flame retardant, heat stabilized (UL 94V-0)
Housing.	1M1-Series: Stainless Steel 1MS-Series: Spring Steel
Actuator Pivot & Mounting Bracket	1M1-Series: Stainless Steel 1MS-Series: Nylon (UL 94V-0)
Actuator Pivot Retainer . . .	1MS-Series: Stainless Steel
Switch Support	Brass, tin plated
Terminal Seal	Epoxy

1M1-Series Ordering Scheme



1 SERIES
1M1 Miniature Rocker Switch

2 POLES
SP single pole - uses terminals 1, 2 & 3.
DP double pole uses terminals 1,2, 3, 4, 5 & 6.
3P double pole uses terminals 1,2, 3, 4, 5, 6, 7, 8 & 9.
4P double pole uses terminals 1,2, 3, 4, 5, 6, 7, 8, 9, 10, 11, 12.

3 CIRCUIT
 () - momentary

Switching Position:
 2-3, 5-6, 8-9, 11-12 OPEN 2-1, 5-4, 8-7, 11-10

1	ON	NONE	ON
2	ON	NONE	(ON)
3	ON	OFF	ON
4	(ON)	OFF	(ON)
5	ON	OFF	(ON)

4 ACTUATOR STYLE

R1	Small rocker	R5	Large rocker
R2	Small paddle	R6	Rocker & frame
R3	Medium rocker	R7	Paddle & frame
R4	Large paddle	R8	Rocker w/out frame
		R9	Paddle w/out frame

5 ACTUATOR COLOR & 6 FRAME COLOR^{1,2}

1 white	4 orange	7 blue
2 black	5 yellow	8 brown
3 red	6 green	9 gray

1 Black is standard. Other colors available, consult factory for details.
 2 Selection 6 is blank if actuator style R8 or R9 (no frame)

7 TERMINATION

M1	Solder Lug	VS4	PC Mount, U bracket, .460 high
M2	PCB	VS5	PC Mount, U bracket, .630 high
M3	Quick Connect	M61	Snap-In, U bracket, 90° horizontal
M5-1	Wire Wrap .750 [19.05]	M71	Snap-In, U bracket, 90° vertical
M5-2	Wire Wrap .964 [24.48]	VS21	Snap-In, U bracket, .620 mounting x .460 high
M5-3	Wire Wrap .425 [10.80]	VS31	Snap-In, U bracket, .620 mounting x .630 high
M5-4	Wire Wrap 1.062 [26.97]	VS41	Snap-In, U bracket .620 mounting x .630 high
M6	PC Mount, 90° horizontal	VS51	Snap-In, U bracket
M7	PC Mount, 90° vertical		
VS2	PC Mount, U bracket, .620 mounting x .460 high		
VS3	PC Mount, U bracket, .620 mounting x .630 high		

8 CONTACT

G	Material	Terminal Plating	Rating	Approvals
G	silver ¹	gold over silver ²	5A@125VAC or 28VDC, 2A @ 250VAC	UL CSA
K	gold ²	tin-lead ⁴	0.4VA max. @20V max (AC/DC)	-
P	silver ¹	tin-lead ⁴	5A@125VAC or 28VDC, 2A @ 250VAC	UL CSA
Q	silver ¹	silver ¹	5A@125VAC or 28VDC, 2A @ 250VAC	UL CSA
R	gold ²	gold ²	0.4VA max. @20V max (AC/DC)	-

NOTE:
 Tin-lead option available with PC type terminations only.
 1 Moveable contact & terminals: copper alloy, silver plate
 2 Moveable contact & terminals: copper alloy with gold plate over nickel plate
 3 Terminals: silver plate with outer layer in gold plating
 4 Outer terminals: copper alloy with tin-lead over nickel plate

9 EPOXY SEAL
E epoxy seal

1MS-Series Ordering Scheme



1 SERIES
1MS Sealed Miniature Rocker Switch

2 POLES
SP single pole - uses terminals 1, 2 & 3.
DP double pole uses terminals 1,2, 3, 4, 5 & 6.
3P double pole uses terminals 1,2, 3, 4, 5, 6, 7, 8 & 9.

3 CIRCUIT
 () - momentary

Switching Position:
 2-3, 5-6, 8-9 OPEN 2-1, 5-4, 8-7

1	ON	NONE	ON
2	ON	NONE	(ON)
3	ON	OFF	ON
4	(ON)	OFF	(ON)
5	ON	OFF	(ON)

4 ACTUATOR STYLE

R1	Small rocker	R5	Large rocker
R2	Small paddle	R6	Rocker & frame
R3	Medium rocker	R7	Paddle & frame
R4	Large paddle	R8	Rocker w/out frame
		R9	Paddle w/out frame

5 TERMINATION

M1	Solder Lug	VS3	PC Mount, U bracket, .620 mounting x .630 high
M2	PCB	VS4	PC Mount, U bracket, .460 high
M3	Quick Connect	VS5	PC Mount, U bracket, .630 high
M5-1	Wire Wrap .750 [19.05]	VS21	Snap-In, U bracket, .620 mounting x .460 high
M5-2	Wire Wrap .964 [24.48]	VS31	Snap-In, U bracket, .620 mounting x .630 high
M5-3	Wire Wrap .425 [10.80]	VS41	Snap-In, U bracket .620 mounting x .630 high
M5-4	Wire Wrap 1.062 [26.97]	VS51	Snap-In, U bracket
M6	PC Mount, 90° horizontal		
M7	PC Mount, 90° vertical		
VS2	PC Mount, U bracket, .620 mounting x .460 high		

6 CONTACT

G	Material	Terminal Plating	Rating	Approvals
G	silver ¹	gold over silver ²	5A@125VAC or 28VDC, 2A @ 250VAC	UL CUL
K	gold ²	tin-lead ⁴	0.4VA max. @20V max (AC/DC)	-
P	silver ¹	tin-lead ⁴	5A@125VAC or 28VDC, 2A @ 250VAC	UL CUL
R	gold ²	gold ²	0.4VA max. @20V max (AC/DC)	-

NOTE:
 Tin-lead option available with PC type terminations only.
 1 Moveable contact & terminals: copper alloy, silver plate
 2 Moveable contact & terminals: copper alloy with gold plate over nickel plate
 3 Terminals: silver plate with outer layer in gold plating
 4 Outer terminals: copper alloy with tin-lead over nickel plate

7 EPOXY SEAL
E epoxy seal

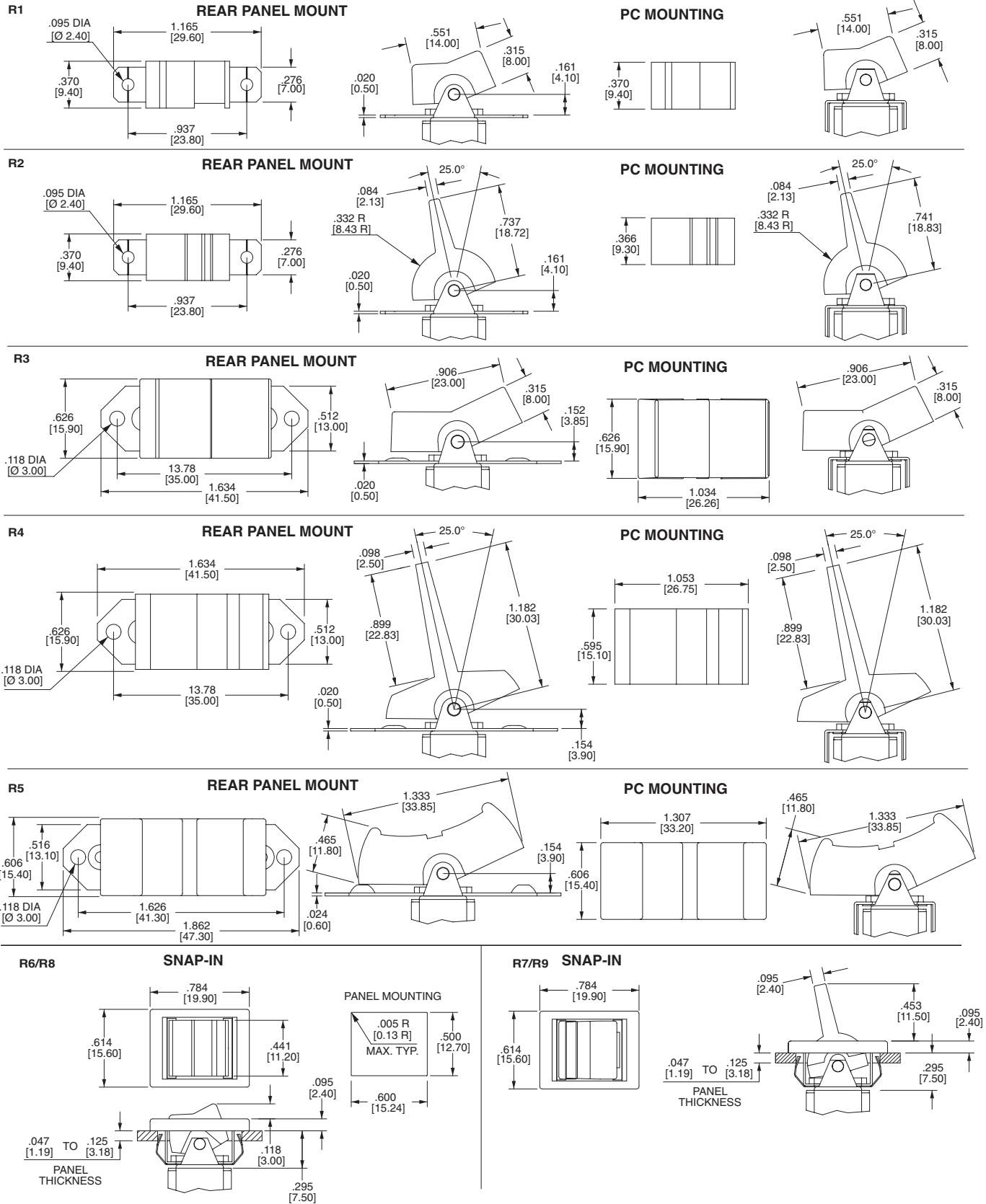
1M1-Series Dimensional Specifications: in.[mm]
ACTUATOR

R8 and R9 are without frame. Actuators are as shown.

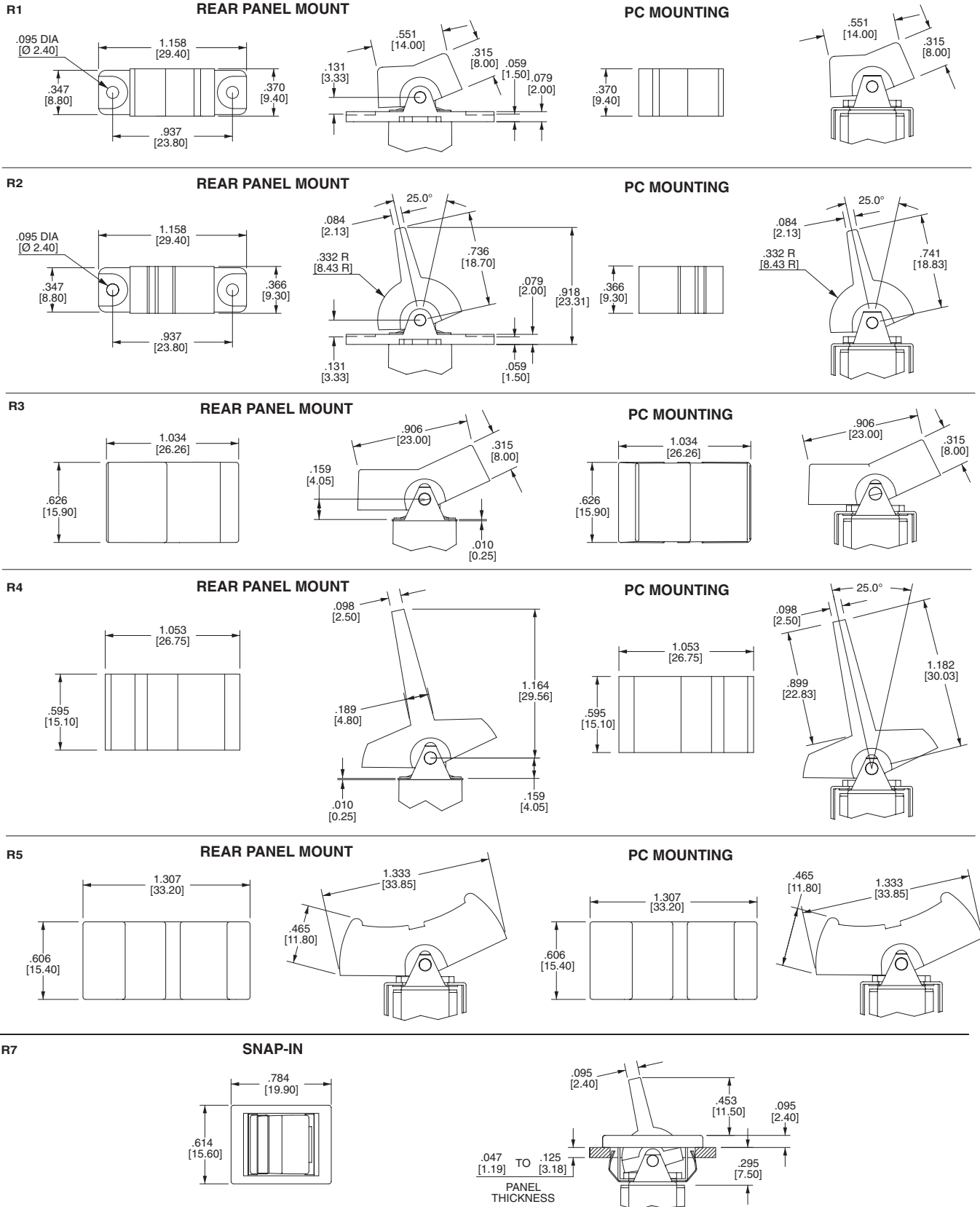
1MS-Series Dimensional Specifications: in.[mm]
ACTUATOR

1M-Series Dimensional Specifications: in.[mm]

TERMINATION

1M1-Series

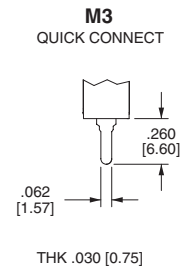
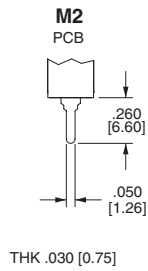
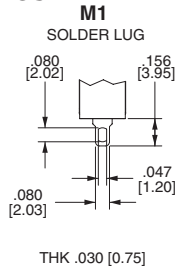

1MS-Series

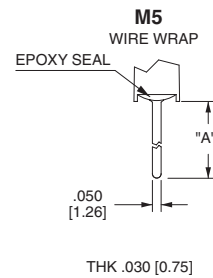
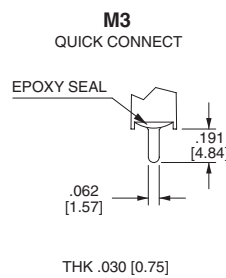
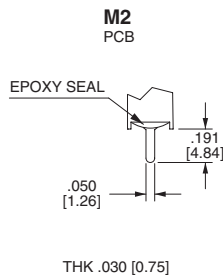
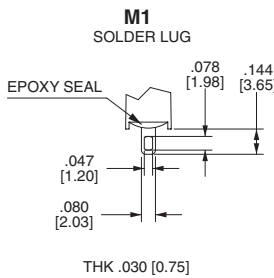

OPTION CODE	DIM. "A"
M5-1	.750 [19.05]
M5-2	.964 [24.48]
M5-3	.425 [10.80]
M5-4	1.062 [26.97]

1M-Series

M6

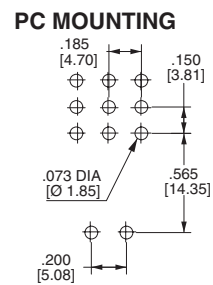
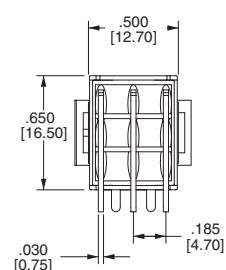
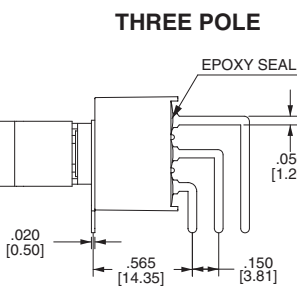
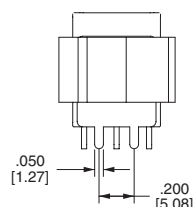
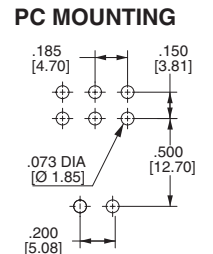
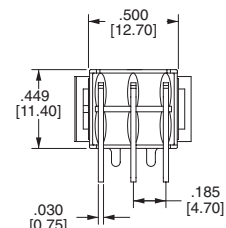
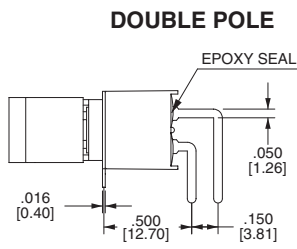
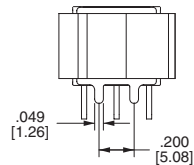
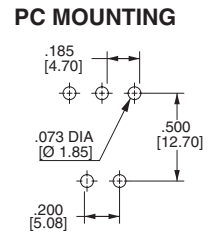
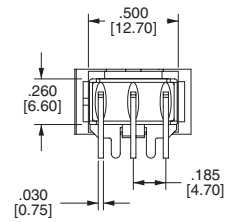
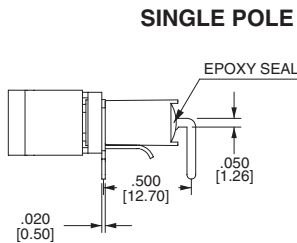
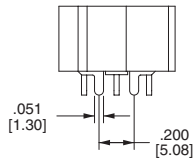

1M-Series Dimensional Specifications: in.[mm]

TERMINATION

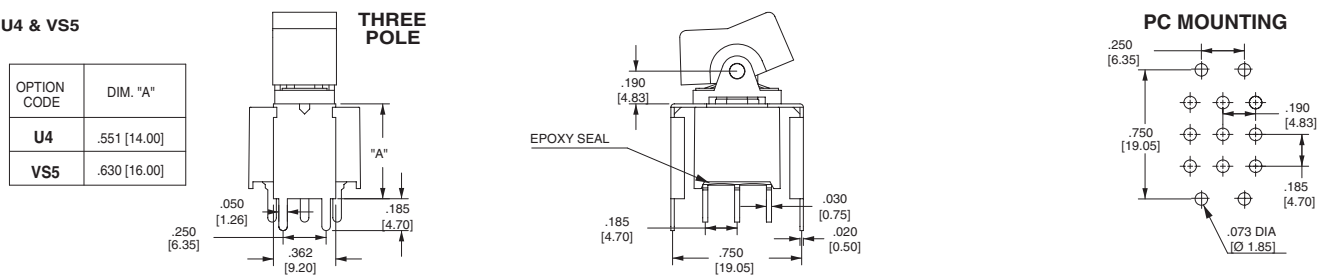
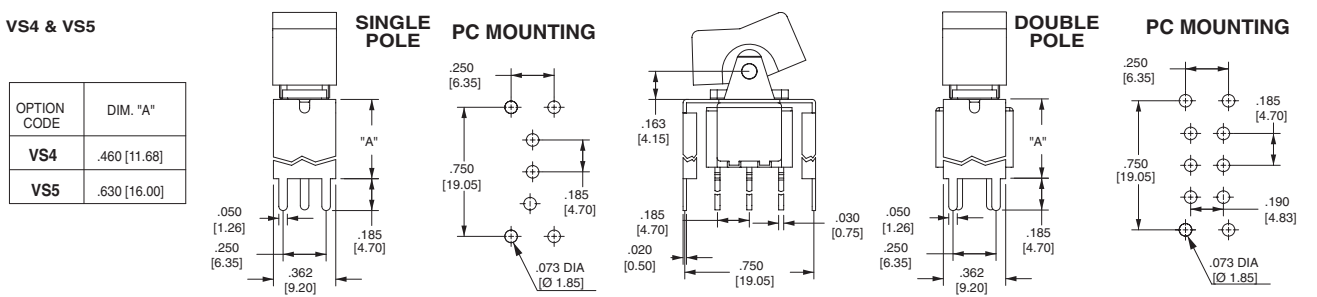
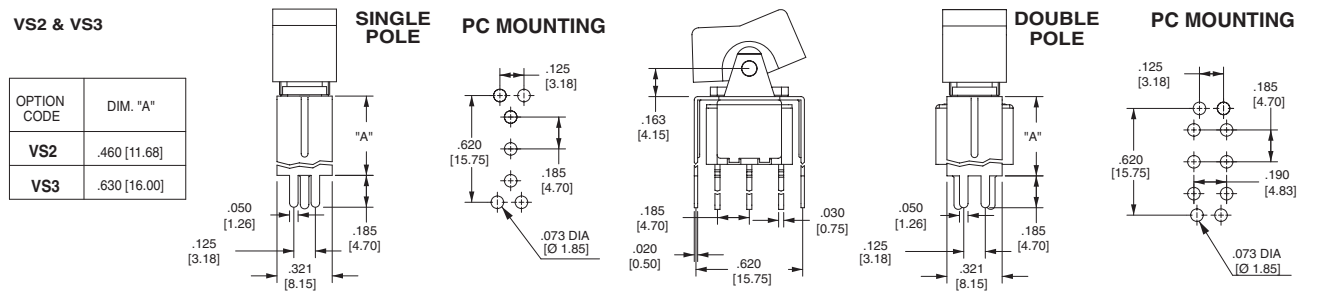
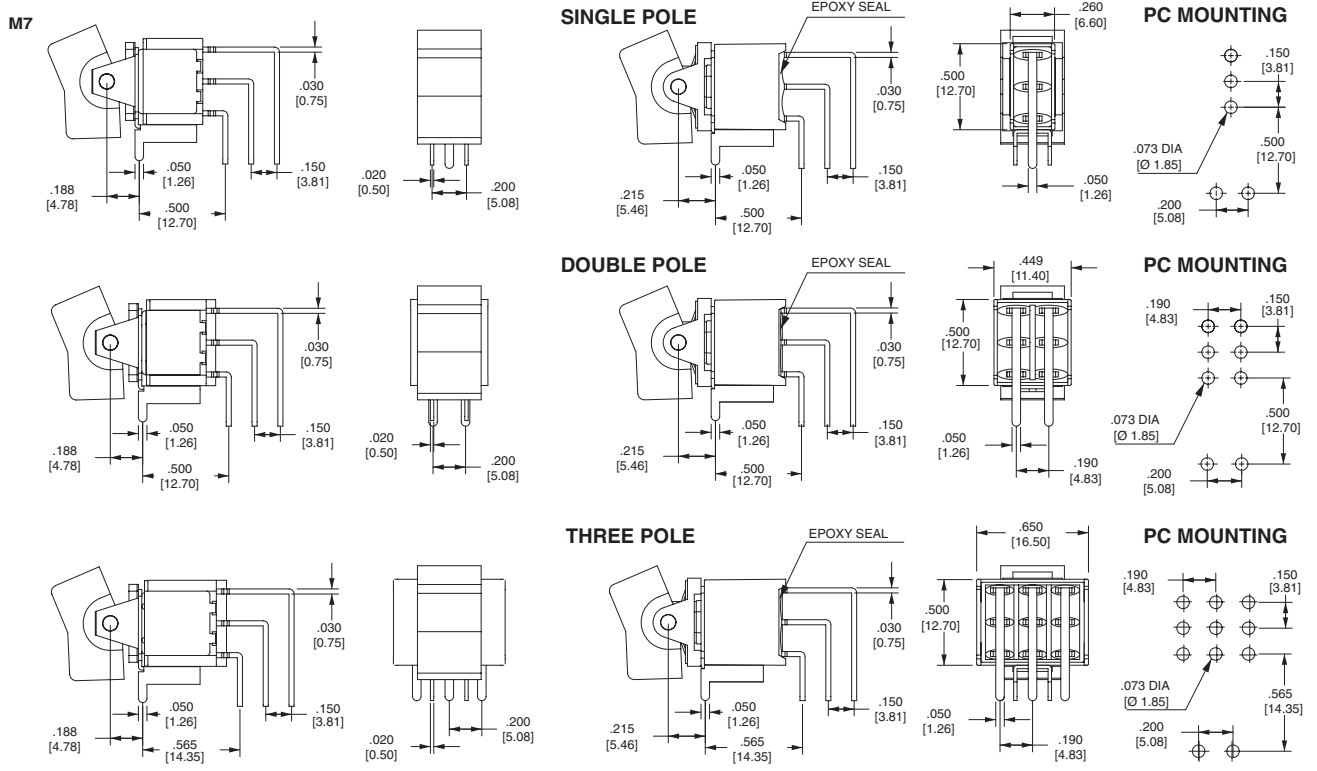



Компания «ЭлектроПласт» предлагает заключение долгосрочных отношений при поставках импортных электронных компонентов на взаимовыгодных условиях!

Наши преимущества:

- Оперативные поставки широкого спектра электронных компонентов отечественного и импортного производства напрямую от производителей и с крупнейших мировых складов;
- Поставка более 17-ти миллионов наименований электронных компонентов;
- Поставка сложных, дефицитных, либо снятых с производства позиций;
- Оперативные сроки поставки под заказ (от 5 рабочих дней);
- Экспресс доставка в любую точку России;
- Техническая поддержка проекта, помощь в подборе аналогов, поставка прототипов;
- Система менеджмента качества сертифицирована по Международному стандарту ISO 9001;
- Лицензия ФСБ на осуществление работ с использованием сведений, составляющих государственную тайну;
- Поставка специализированных компонентов (Xilinx, Altera, Analog Devices, Intersil, Interpoint, Microsemi, Aeroflex, Peregrine, Syfer, Eurofarad, Texas Instrument, Miteq, Cobham, E2V, MA-COM, Hittite, Mini-Circuits, General Dynamics и др.);

Помимо этого, одним из направлений компании «ЭлектроПласт» является направление «Источники питания». Мы предлагаем Вам помощь Конструкторского отдела:

- Подбор оптимального решения, техническое обоснование при выборе компонента;
- Подбор аналогов;
- Консультации по применению компонента;
- Поставка образцов и прототипов;
- Техническая поддержка проекта;
- Защита от снятия компонента с производства.



Как с нами связаться

Телефон: 8 (812) 309 58 32 (многоканальный)

Факс: 8 (812) 320-02-42

Электронная почта: org@eplast1.ru

Адрес: 198099, г. Санкт-Петербург, ул. Калинина, дом 2, корпус 4, литера А.