

Features

- Superior circuit protection
- Overcurrent protection
- Blocks surges up to rated voltage limit
- High-speed performance
- Small SMT package
- RoHS compliant*

Applications

- RS-485 interfaces
- Exposed sense and data lines
- Factory automation
- Protection modules and dongles
- Process control equipment
- Test and measurement equipment
- General electronics

TBU-DF Series - TBU® High-Speed Protectors

General Information

The TBU-DF Series of Bourns® TBU® products are low capacitance dual bidirectional high-speed Electronic Current Limiters (ECLs), constructed using MOSFET semiconductor technology, and designed to protect against faults caused by short circuits, overvoltage transients and faults in battery cells, up to rated limits.

The TBU® high-speed protector placed in the system circuit will monitor the current with the MOSFET detection circuit triggering to provide an effective barrier behind which sensitive electronics will not be exposed to large voltages or currents during transient events.

The TBU® device is provided in a surface mount DFN package and meets industry standard requirements such as RoHS and Pb Free solder reflow profiles.

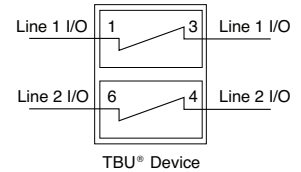

Absolute Maximum Ratings (@ T_A = 25 °C Unless Otherwise Noted)

Symbol	Parameter	Part Number	Value	Unit
V _{imp}	Peak impulse voltage withstand with duration less than 10 ms	TBU-DF055-xxx-WH TBU-DF085-xxx-WH	550 850	V
V _{rms}	Continuous A.C. RMS voltage	TBU-DF055-xxx-WH TBU-DF085-xxx-WH	250 425	V
T _{op}	Operating temperature range		-55 to +125	°C
T _{stg}	Storage temperature range		-65 to +150	°C
T _{amax}	Maximum Ambient Temperature		+125	°C

Electrical Characteristics (@ T_A = 25 °C Unless Otherwise Noted)

Symbol	Parameter	Part Number	Min.	Typ.	Max.	Unit
I _{trigger}	Current required for the device to go from operating state to protected state	TBU-DFxxx-050-WH TBU-DFxxx-300-WH TBU-DFxxx-500-WH	50 300 500	75 450 750	100 600 1000	mA
R _{device}	Series resistance of the TBU® device	V _{imp} = 550 V I _{trigger} (min.) = 50 mA V _{imp} = 550 V I _{trigger} (min.) = 300 mA V _{imp} = 550 V I _{trigger} (min.) = 500 mA TBU-DF055-050-WH TBU-DF055-300-WH TBU-DF055-500-WH V _{imp} = 850 V I _{trigger} (min.) = 50 mA V _{imp} = 850 V I _{trigger} (min.) = 300 mA V _{imp} = 850 V I _{trigger} (min.) = 500 mA TBU-DF085-050-WH TBU-DF085-300-WH TBU-DF085-500-WH	12 6 5 23 15 12		26 14 13 38 26 25	Ω
R _{match}	Package resistance matching of the TBU® device #1 - TBU® device #2				+0.5	Ω
t _{block}	Time for the device to go from normal operating state to protected state			1		μs
I _Q	Current through the triggered TBU® device with 50 Vdc circuit voltage			0.5		mA
V _{reset}	Voltage below which the triggered TBU® device will transition to normal operating state		12	16	20	V
R _{th(j-a)}	Junction to ambient - FR4 using JESD51-3 board			125		°C/W
R _{th(j-a)}	Junction to ambient - FR4 using JESD51-7 board			50		°C/W

Environmental Characteristics

Parameter	Value
Moisture Sensitivity Level	1
ESD Classification (HBM)	1B



WARNING Cancer and Reproductive Harm - www.P65Warnings.ca.gov

*RoHS Directive 2015/863, Mar 31, 2015 and Annex.

Specifications are subject to change without notice.

Users should verify actual device performance in their specific applications.

The products described herein and this document are subject to specific legal disclaimers as set forth on the last page of this document, and at www.bourns.com/docs/legal/disclaimer.pdf.

Reference Application

The TBU® devices are general use protectors used in a wide variety of applications, including telecommunications, industrial communications and automotive battery management systems. The maximum voltage rating of the TBU® device should never be exceeded. Where necessary, an OVP device should be employed to limit the maximum voltage. A cost-effective protection solution combines Bourns® TBU® protection devices with a pair of Bourns® TISP® Overvoltage Protectors or MOVs. For bandwidth sensitive applications, a Bourns® GDT may be substituted for the MOV.

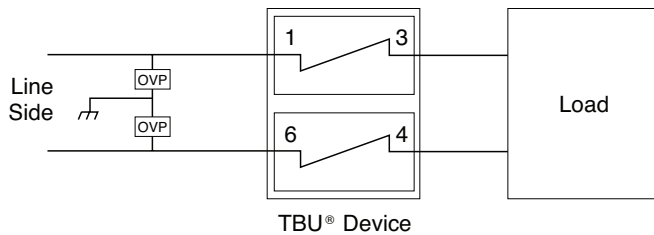

Basic TBU Operation

The TBU® device, constructed using MOSFET semiconductor technology, placed in the system circuit will monitor the current with the MOSFET detection circuit triggering to provide an effective barrier behind which sensitive electronics are not exposed to large voltages or currents during transient events. When operated, the TBU® device will limit the current to less than the I_{trigger} value within the t_{block} duration. If voltage above V_{reset} is continuously sustained, the TBU® device will subsequently reduce the current to a quiescent current level within a period of time that is dependent upon the applied voltage.

After the surge, the TBU® device resets when the voltage across the TBU® device falls to the V_{reset} level. The TBU® device will automatically reset on lines which have no DC bias or have DC bias below V_{reset} (such as unpowered signal lines).

Performance Graphs

Typical V-I Characteristics

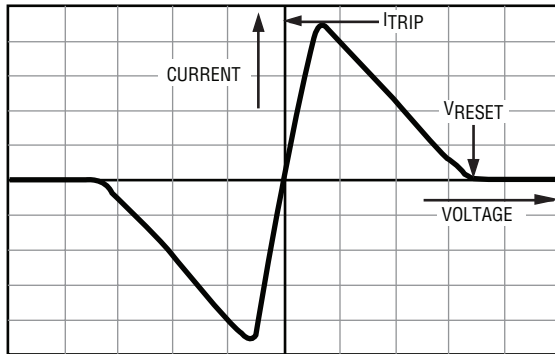

Normalized Itrigger vs. Temperature

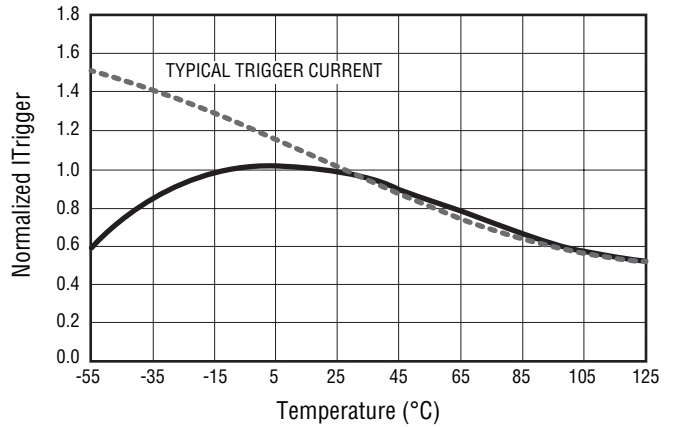

Power Derating Curve

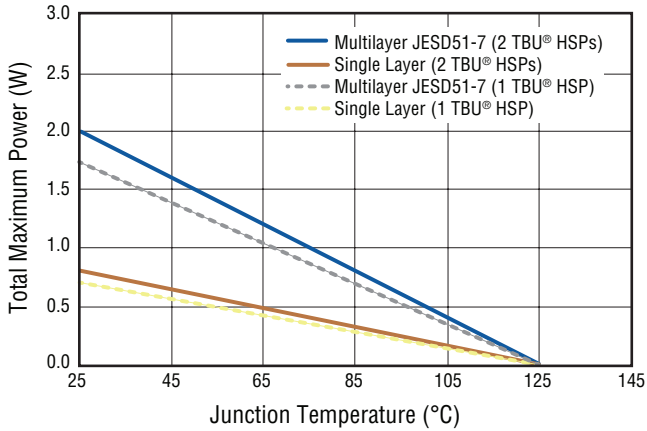

Normalized Resistance vs. Temperature

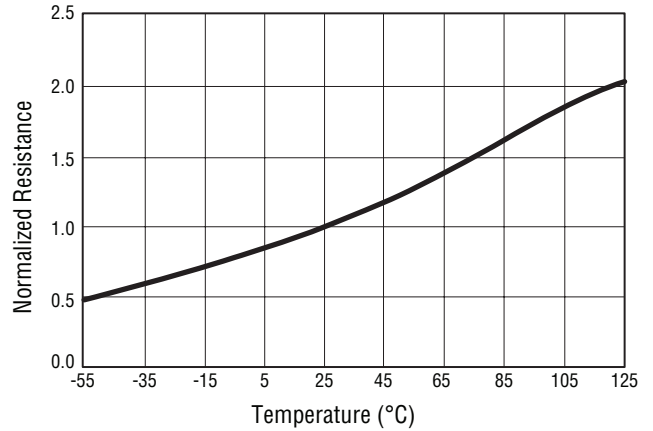

Specifications are subject to change without notice.

Users should verify actual device performance in their specific applications.

The products described herein and this document are subject to specific legal disclaimers as set forth on the last page of this document, and at www.bourns.com/docs/legal/disclaimer.pdf.

Product Dimensions

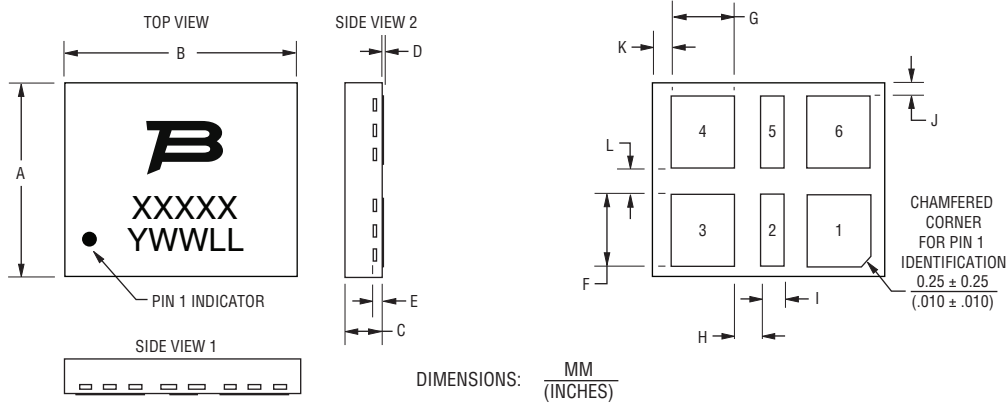

Dim.	Min.	Nom.	Max.
A	$\frac{5.40}{(.213)}$	$\frac{5.50}{(.217)}$	$\frac{5.60}{(.220)}$
B	$\frac{6.40}{(.252)}$	$\frac{6.50}{(.256)}$	$\frac{6.60}{(.260)}$
C	$\frac{0.80}{(.031)}$	$\frac{0.90}{(.035)}$	$\frac{1.00}{(.039)}$
D	$\frac{0.00}{(.000)}$	--	$\frac{0.05}{(.002)}$
E	$\frac{0.20}{(.008)}$ REF.		
F	$\frac{1.90}{(.075)}$	$\frac{2.00}{(.079)}$	$\frac{2.10}{(.083)}$
G	$\frac{1.75}{(.069)}$	$\frac{1.85}{(.073)}$	$\frac{1.95}{(.077)}$
H	$\frac{0.65}{(.026)}$	$\frac{0.70}{(.028)}$	$\frac{0.75}{(.030)}$
I	$\frac{0.70}{(.028)}$	$\frac{0.80}{(.031)}$	$\frac{0.90}{(.035)}$
J	$\frac{0.30}{(.012)}$	$\frac{0.35}{(.014)}$	$\frac{0.40}{(.016)}$
K	$\frac{0.25}{(.010)}$	$\frac{0.30}{(.012)}$	$\frac{0.35}{(.014)}$
L	$\frac{0.75}{(.030)}$	$\frac{0.80}{(.031)}$	$\frac{0.85}{(.033)}$

Pad #	Pin Out
1	Line 1 In/Out
2	NU (Not Used)
3	Line 1 In/Out
4	Line 2 In/Out
5	NU (Not Used)
6	Line 2 In/Out

NOTES:

1. Pin 1 Indicator is laser marked; radius and location within the Pin 1 terminal.
Pin 1 dot size: 0.500 ± 0.125 mm / $(.020 \pm .005$ in.).
2. Pin 2 and 5 are NU (Not Used) and must be left unconnected; do not connect to In/Out lines, do not connect to system Ground.
3. Coplanarity on exposed pads shall not exceed 0.08 mm / (.003 in.).
4. Warpage shall not exceed 0.10 mm / (.004 in.) on all surfaces.
5. Exposed tie bars at package side are not plated.

Specifications are subject to change without notice.

Users should verify actual device performance in their specific applications.

The products described herein and this document are subject to specific legal disclaimers as set forth on the last page of this document, and at www.bourns.com/docs/legal/disclaimer.pdf.

TBU-DF Series - TBU® High-Speed Protectors

BOURNS®

Recommended Pad Layout

TBU® High-Speed Protectors have a 100 % matte-tin termination finish. For improved thermal dissipation, the recommended layout uses PCB copper areas which extend beyond the exposed solder pad. The exposed solder pads should be defined by a solder mask which matches the pad layout of the TBU® device in size and spacing. It is recommended that they should be the same dimension as the TBU® pads but if smaller solder pads are used, they should be centered on the TBU® package terminal pads and not more than 0.10-0.12 mm (0.004-0.005 in.) smaller in overall width or length. Solder pad areas should not be larger than the TBU® pad sizes to ensure adequate clearance is maintained. The recommended stencil thickness is 0.10-0.12 mm (0.004-0.005 in.) with a stencil opening size 0.025 mm (0.0010 in.) less than the solder pad size. Extended copper areas beyond the solder pad significantly improve the junction to ambient thermal resistance, resulting in operation at lower junction temperatures with a corresponding benefit of reliability. All pads should soldered to the PCB, including pads marked as NC or NU but no electrical connection should be made to these pads. Care should be taken to assure no resistive path exists between the NC or NU pins to any other point to avoid

unexpected performance issues. For minimum parasitic capacitance, it is recommended that signal, ground or power signals are not routed beneath any pad. For minimum parasitic capacitance, it is recommended that signal, ground or power signals are not routed beneath any pad.

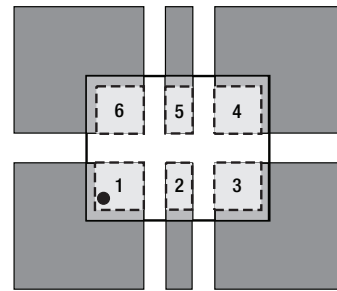

Dark grey areas show added PCB copper area for better thermal resistance.

Reflow Profile

Profile Feature	Pb-Free Assembly
Average Ramp-Up Rate (T _{smax} to T _p)	3 °C/sec. max.
Preheat	
- Temperature Min. (T _{sm})	150 °C
- Temperature Max. (T _{smax})	200 °C
- Time (t _{sm} to t _{smax})	60-180 sec.
Time maintained above:	
- Temperature (T _L)	217 °C
- Time (t _L)	60-150 sec.
Peak/Classification Temperature (T _p)	260 °C
Time within 5 °C of Actual Peak Temp. (t _p)	20-40 sec.
Ramp-Down Rate	6 °C/sec. max.
Time 25 °C to Peak Temperature	8 min. max.

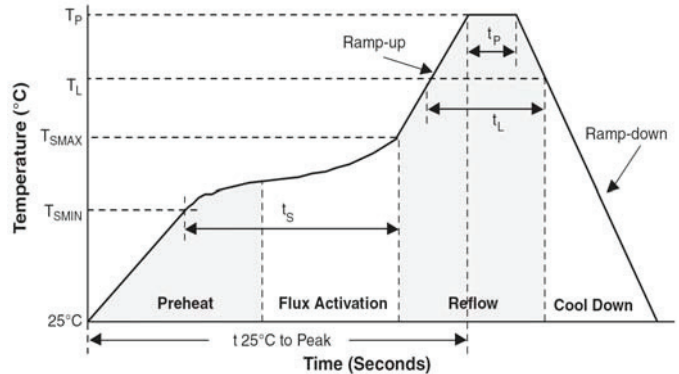

How to Order

TBU - DF xxx - yyy - WH

TBU® Product _____

Series _____
DF = Dual Bidirectional Series

Impulse Voltage Rating _____
055 = 550 V
085 = 850 V

Trigger Current _____
050 = 50 mA
300 = 300 mA
500 = 500 mA

Hold to Trip Ratio Suffix _____
W = Hold to Trip Ratio

Package Suffix _____
H = DFN Package

Typical Part Marking

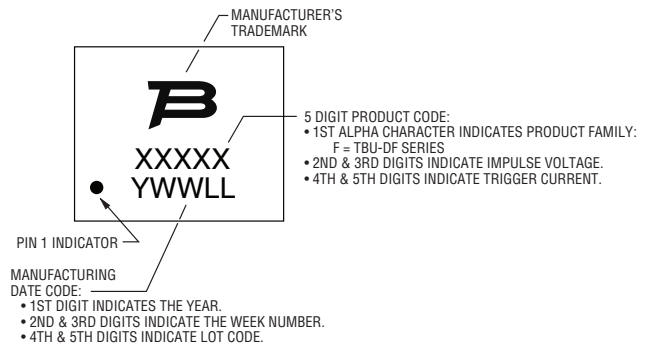

Specifications are subject to change without notice.

Users should verify actual device performance in their specific applications.

The products described herein and this document are subject to specific legal disclaimers as set forth on the last page of this document, and at www.bourns.com/docs/legal/disclaimer.pdf.

TBU-DF Series - TBU® High-Speed Protectors

BOURNS®

Packaging Specifications

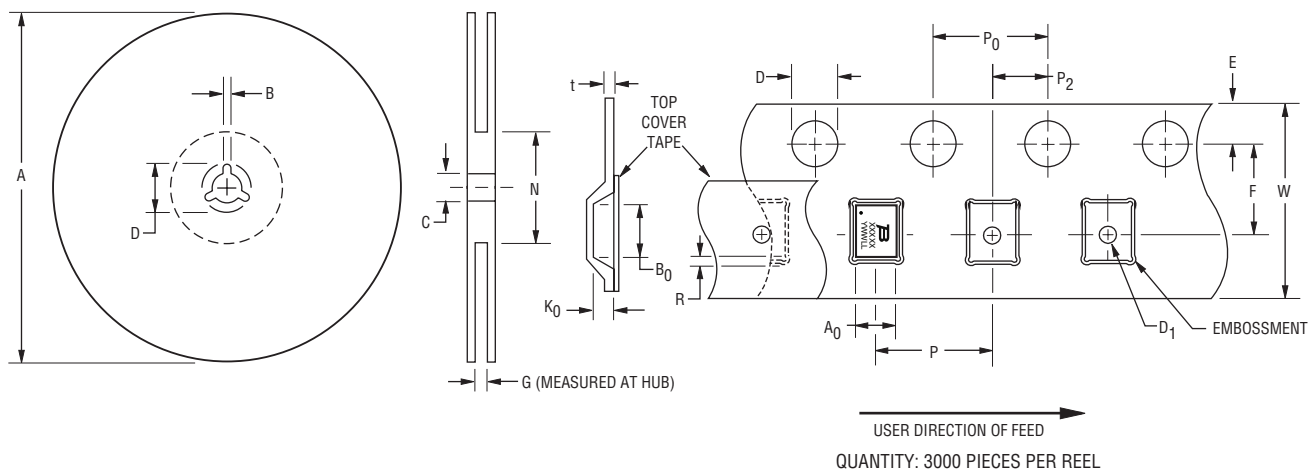

A		B		C		D		G	N
Min.	Max.	Min.	Max.	Min.	Max.	Min.	Max.	Ref.	Ref.
328.5	331	2.0	2.4	12.8	13.5	17.0	17.4	16.5	100 ± 1.5
(12.93)	(13.05)	(0.079)	(0.094)	(0.504)	(.531)	(0.669)	(0.690)	(0.650)	(3.94 ± 0.059)

A0		B0		D0		D1		E		F	
Min.	Max.	Min.	Max.	Min.	Max.	Min.	Max.	Min.	Max.	Min.	Max.
5.75	5.95	6.75	6.95	1.5	1.6	1.5	-	1.65	1.85	7.4	7.6
(0.224)	(0.234)	(0.266)	(0.274)	(0.059)	(0.063)	(0.059)		(0.065)	(0.073)	(0.291)	(0.299)
K0		P		P0		P2		R		t	
Min.	Max.	Min.	Max.	Min.	Max.	Min.	Max.	Min.	Max.	Min.	Max.
1.05	1.25	7.9	8.1	3.9	4.1	1.9	2.1	0	0.5	0.25	0.35
(0.041)	(0.049)	(0.311)	(0.319)	(0.159)	(0.161)	(0.075)	(0.083)	(0)	(.020)	(0.010)	(0.014)
W											
Min.	Max.										
15.7	16.3										
(0.618)	(0.642)										

DIMENSIONS: $\frac{\text{MM}}{\text{(INCHES)}}$

BOURNS®

Asia-Pacific: Tel: +886-2 2562-4117 • Email: asiacus@bourns.com

EMEA: Tel: +36 88 520 390 • Email: eurocus@bourns.com

The Americas: Tel: +1-951 781-5500 • Email: americus@bourns.com

www.bourns.com

10/18

"TBU" is a registered trademark of Bourns, Inc. in the United States and other countries, except Japan. All references to TBU® in this document for use in Japan shall be deemed to be replaced with Bourns® TBU™.

Specifications are subject to change without notice.

Users should verify actual device performance in their specific applications.

The products described herein and this document are subject to specific legal disclaimers as set forth on the last page of this document, and at www.bourns.com/docs/legal/disclaimer.pdf.

This legal disclaimer applies to purchasers and users of Bourns® products manufactured by or on behalf of Bourns, Inc. and its affiliates (collectively, “Bourns”).

Unless otherwise expressly indicated in writing, Bourns® products and data sheets relating thereto are subject to change without notice. Users should check for and obtain the latest relevant information and verify that such information is current and complete before placing orders for Bourns® products.

The characteristics and parameters of a Bourns® product set forth in its data sheet are based on laboratory conditions, and statements regarding the suitability of products for certain types of applications are based on Bourns’ knowledge of typical requirements in generic applications. The characteristics and parameters of a Bourns® product in a user application may vary from the data sheet characteristics and parameters due to (i) the combination of the Bourns® product with other components in the user’s application, or (ii) the environment of the user application itself. The characteristics and parameters of a Bourns® product also can and do vary in different applications and actual performance may vary over time. Users should always verify the actual performance of the Bourns® product in their specific devices and applications, and make their own independent judgments regarding the amount of additional test margin to design into their device or application to compensate for differences between laboratory and real world conditions.

Unless Bourns has explicitly designated an individual Bourns® product as meeting the requirements of a particular industry standard (e.g., ISO/TS 16949) or a particular qualification (e.g., UL listed or recognized), Bourns is not responsible for any failure of an individual Bourns® product to meet the requirements of such industry standard or particular qualification. Users of Bourns® products are responsible for ensuring compliance with safety-related requirements and standards applicable to their devices or applications.

Bourns® products are not recommended, authorized or intended for use in nuclear, lifesaving, life-critical or life-sustaining applications, nor in any other applications where failure or malfunction may result in personal injury, death, or severe property or environmental damage. Unless expressly and specifically approved in writing by two authorized Bourns representatives on a case-by-case basis, use of any Bourns® products in such unauthorized applications might not be safe and thus is at the user’s sole risk. Life-critical applications include devices identified by the U.S. Food and Drug Administration as Class III devices and generally equivalent classifications outside of the United States.

Bourns expressly identifies those Bourns® standard products that are suitable for use in automotive applications on such products’ data sheets in the section entitled “Applications.” Unless expressly and specifically approved in writing by two authorized Bourns representatives on a case-by-case basis, use of any other Bourns® standard products in an automotive application might not be safe and thus is not recommended, authorized or intended and is at the user’s sole risk. If Bourns expressly identifies a sub-category of automotive application in the data sheet for its standard products (such as infotainment or lighting), such identification means that Bourns has reviewed its standard product and has determined that if such Bourns® standard product is considered for potential use in automotive applications, it should only be used in such sub-category of automotive applications. Any reference to Bourns® standard product in the data sheet as compliant with the AEC-Q standard or “automotive grade” does not by itself mean that Bourns has approved such product for use in an automotive application.

Bourns® standard products are not tested to comply with United States Federal Aviation Administration standards generally or any other generally equivalent governmental organization standard applicable to products designed or manufactured for use in aircraft or space applications. Bourns expressly identifies Bourns® standard products that are suitable for use in aircraft or space applications on such products’ data sheets in the section entitled “Applications.” Unless expressly and specifically approved in writing by two authorized Bourns representatives on a case-by-case basis, use of any other Bourns® standard product in an aircraft or space application might not be safe and thus is not recommended, authorized or intended and is at the user’s sole risk.

The use and level of testing applicable to Bourns® custom products shall be negotiated on a case-by-case basis by Bourns and the user for which such Bourns® custom products are specially designed. Absent a written agreement between Bourns and the user regarding the use and level of such testing, the above provisions applicable to Bourns® standard products shall also apply to such Bourns® custom products.

Users shall not sell, transfer, export or re-export any Bourns® products or technology for use in activities which involve the design, development, production, use or stockpiling of nuclear, chemical or biological weapons or missiles, nor shall they use Bourns® products or technology in any facility which engages in activities relating to such devices. The foregoing restrictions apply to all uses and applications that violate national or international prohibitions, including embargos or international regulations. Further, Bourns® products and Bourns technology and technical data may not under any circumstance be exported or re-exported to countries subject to international sanctions or embargoes. Bourns® products may not, without prior authorization from Bourns and/or the U.S. Government, be resold, transferred, or re-exported to any party not eligible to receive U.S. commodities, software, and technical data.

To the maximum extent permitted by applicable law, Bourns disclaims (i) any and all liability for special, punitive, consequential, incidental or indirect damages or lost revenues or lost profits, and (ii) any and all implied warranties, including implied warranties of fitness for particular purpose, non-infringement and merchantability.

For your convenience, copies of this Legal Disclaimer Notice with German, Spanish, Japanese, Traditional Chinese and Simplified Chinese bilingual versions are available at:

Web Page: <http://www.bourns.com/legal/disclaimers-terms-and-policies>

PDF: <http://www.bourns.com/docs/Legal/disclaimer.pdf>



Компания «ЭлектроПласт» предлагает заключение долгосрочных отношений при поставках импортных электронных компонентов на взаимовыгодных условиях!

Наши преимущества:

- Оперативные поставки широкого спектра электронных компонентов отечественного и импортного производства напрямую от производителей и с крупнейших мировых складов;
- Поставка более 17-ти миллионов наименований электронных компонентов;
- Поставка сложных, дефицитных, либо снятых с производства позиций;
- Оперативные сроки поставки под заказ (от 5 рабочих дней);
- Экспресс доставка в любую точку России;
- Техническая поддержка проекта, помощь в подборе аналогов, поставка прототипов;
- Система менеджмента качества сертифицирована по Международному стандарту ISO 9001;
- Лицензия ФСБ на осуществление работ с использованием сведений, составляющих государственную тайну;
- Поставка специализированных компонентов (Xilinx, Altera, Analog Devices, Intersil, Interpoint, Microsemi, Aeroflex, Peregrine, Syfer, Eurofarad, Texas Instrument, Miteq, Cobham, E2V, MA-COM, Hittite, Mini-Circuits, General Dynamics и др.);

Помимо этого, одним из направлений компании «ЭлектроПласт» является направление «Источники питания». Мы предлагаем Вам помощь Конструкторского отдела:

- Подбор оптимального решения, техническое обоснование при выборе компонента;
- Подбор аналогов;
- Консультации по применению компонента;
- Поставка образцов и прототипов;
- Техническая поддержка проекта;
- Защита от снятия компонента с производства.



Как с нами связаться

Телефон: 8 (812) 309 58 32 (многоканальный)

Факс: 8 (812) 320-02-42

Электронная почта: org@eplast1.ru

Адрес: 198099, г. Санкт-Петербург, ул. Калинина, дом 2, корпус 4, литера А.