

## STRADELLA-IP-28-T2-PC

IESNA Type II (medium) beam, applicable for European P-class standard pedestrian lighting and M-class roads. Variant made from PC.

### TECHNICAL SPECIFICATIONS:

Dimensions	100.0 mm
Height	9.2 mm
Fastening	screw
ROHS compliant	yes ⓘ

### MATERIAL SPECIFICATIONS:

Component	Type	Material	Colour	Finish
STRADELLA-IP-28-T2-PC	Multi-lens	PC	clear	
STRADELLA-28-SEAL	Seal	Silicone	white	





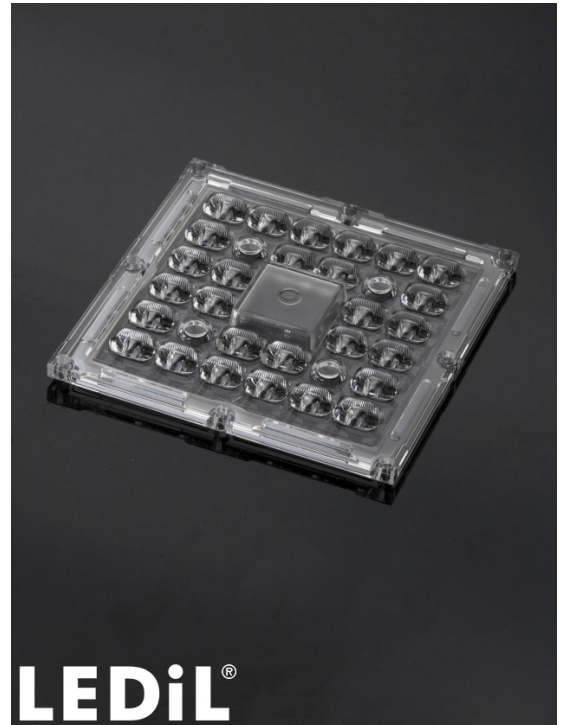

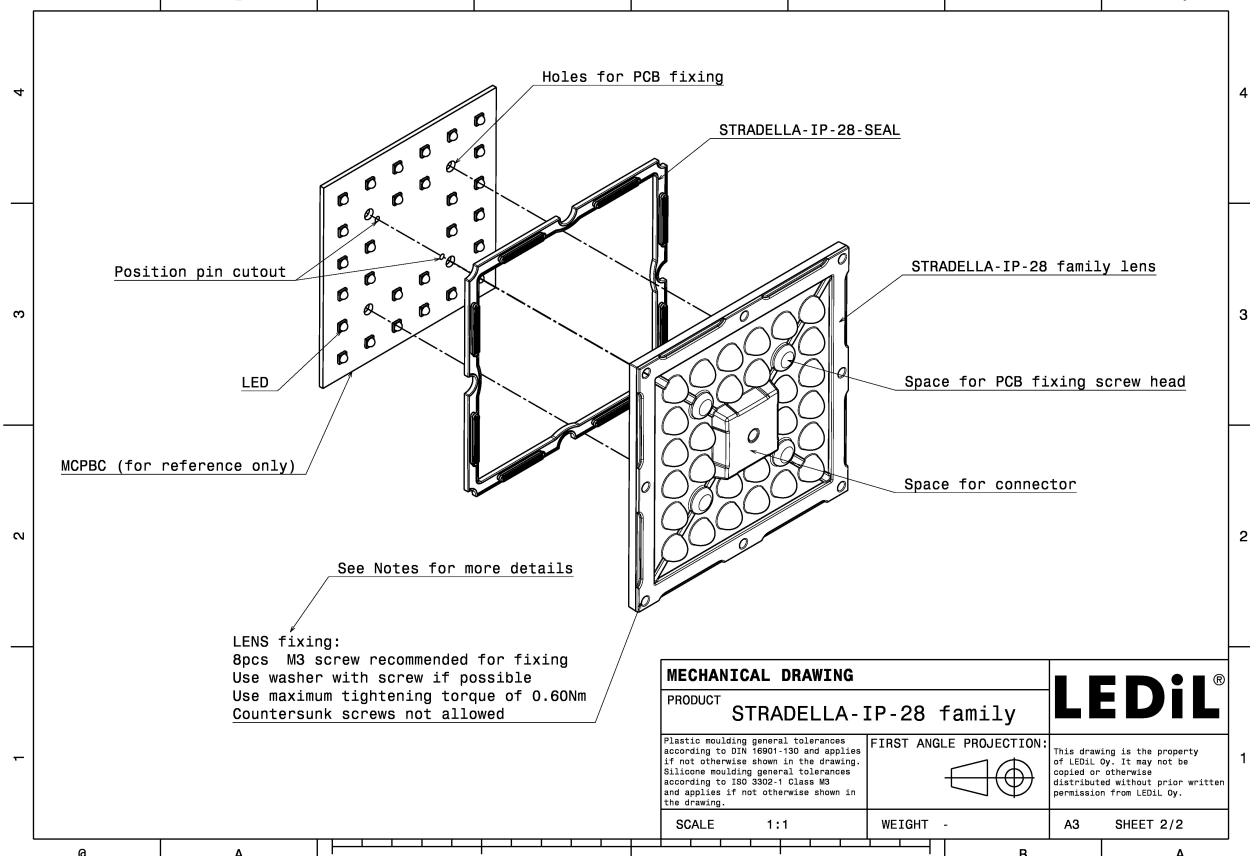
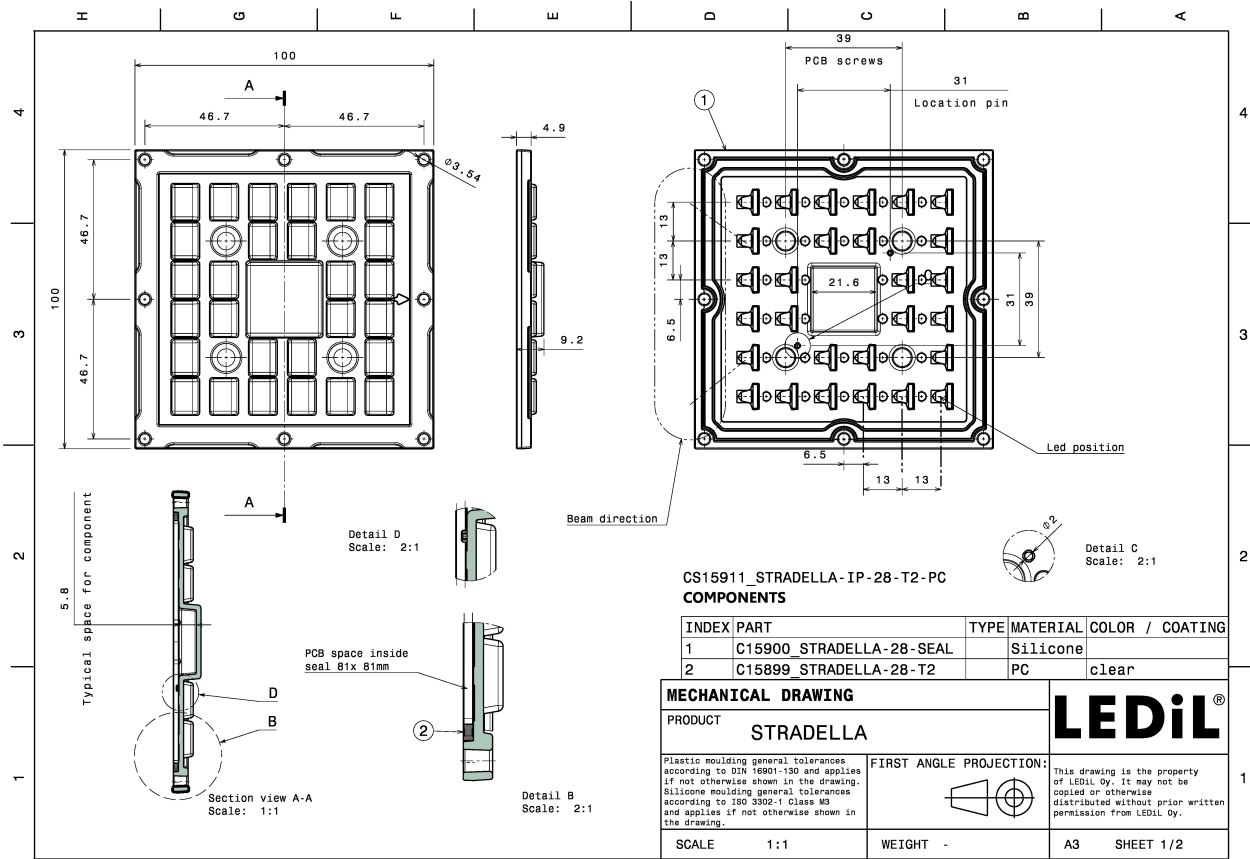
### ORDERING INFORMATION:

Component		Qty in box	MOQ	MPQ	Box weight (kg)
CS15911_STRADELLA-IP-28-T2-PC	Multi-lens	156	78	78	6.1
» Box size: 476 x 273 x 247 mm					

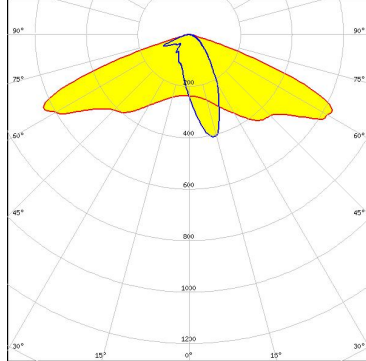

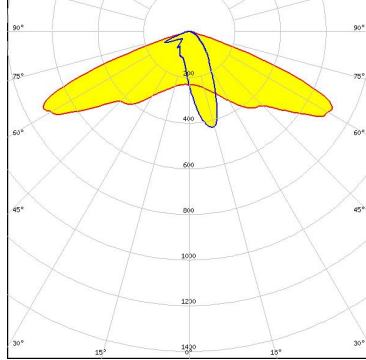

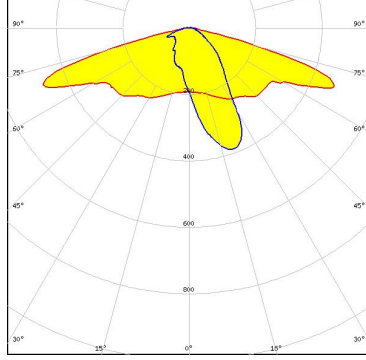
#### PHOTOMETRIC DATA (MEASURED):

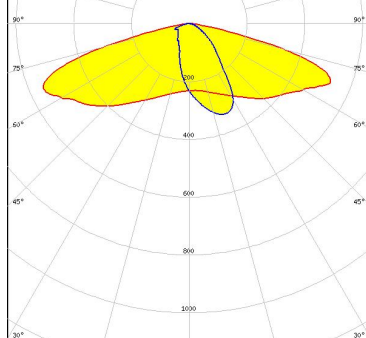
 <p> <b>LED</b> HiQLED STR28 CR JE2835 4x7 xxx  <b>FWHM</b> Asymmetric  <b>Efficiency</b> 90 %  <b>Peak intensity</b> 1 cd/lm  <b>LEDs/each optic</b> 1  <b>Light colour</b> White  <b>Required components:</b> </p>	
 <p> <b>LED</b> HiQLED STR28 CR JÐ§3030 4x7 xxx  <b>FWHM</b> Asymmetric  <b>Efficiency</b> 90 %  <b>Peak intensity</b> 1.1 cd/lm  <b>LEDs/each optic</b> 1  <b>Light colour</b> White  <b>Required components:</b> </p>	
 <p> <b>LED</b> QUICK FLUX STR28 XD2x14 xxx G8  <b>FWHM</b> Asymmetric  <b>Efficiency</b> 90 %  <b>Peak intensity</b> 0.9 cd/lm  <b>LEDs/each optic</b> 1  <b>Light colour</b> White  <b>Required components:</b> </p>	
 <p> <b>LED</b> QUICK FLUX STR28 XP2x14 xxx G7  <b>FWHM</b> Asymmetric  <b>Efficiency</b> 91 %  <b>Peak intensity</b> 0.6 cd/lm  <b>LEDs/each optic</b> 1  <b>Light colour</b> White  <b>Required components:</b> </p>	

#### PHOTOMETRIC DATA (MEASURED):



**LED** QUICK FLUX STR28 XT2x14 xxx G5  
**FWHM** Asymmetric  
**Efficiency** 91 %  
**Peak intensity** 0.6 cd/lm  
**LEDs/each optic** 1  
**Light colour** White  
**Required components:**

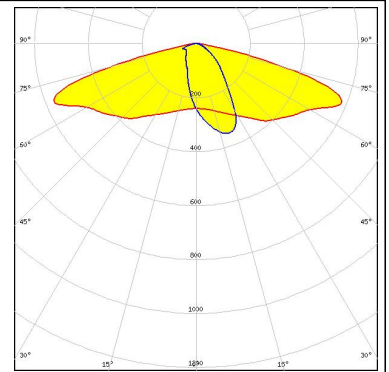

**LED** J Series 2835  
**FWHM** Asymmetric  
**Efficiency** 90 %  
**Peak intensity** 1 cd/lm  
**LEDs/each optic** 1  
**Light colour** White  
**Required components:**

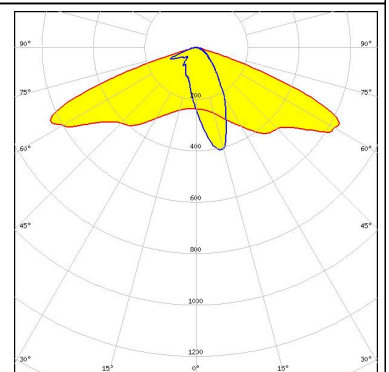

**LED** J Series 3030  
**FWHM** Asymmetric  
**Efficiency** 90 %  
**Peak intensity** 1.1 cd/lm  
**LEDs/each optic** 1  
**Light colour** White  
**Required components:**

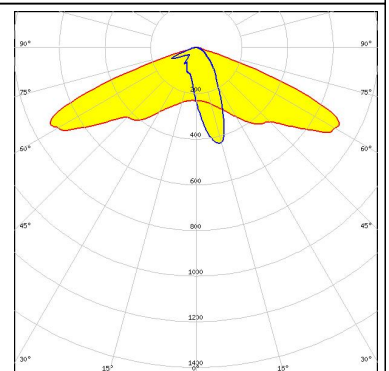

**LED** XD16  
**FWHM** Asymmetric  
**Efficiency** 90 %  
**Peak intensity** 0.9 cd/lm  
**LEDs/each optic** 1  
**Light colour** White  
**Required components:**

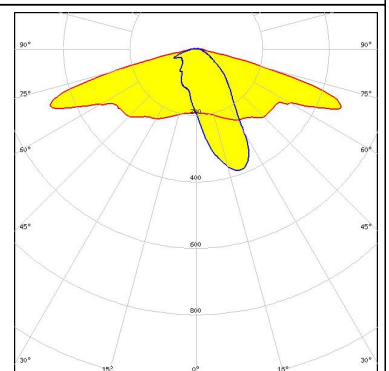

#### PHOTOMETRIC DATA (MEASURED):



LED XP-G3  
 FWHM Asymmetric  
 Efficiency 91 %  
 Peak intensity 0.6 cd/lm  
 LEDs/each optic 1  
 Light colour White  
 Required components:

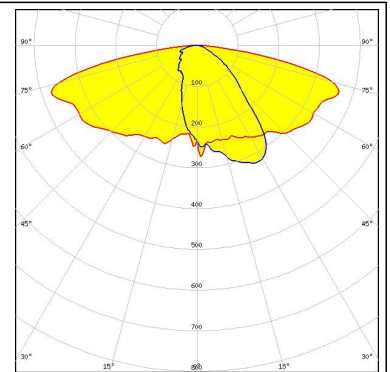

LED XT-E  
 FWHM Asymmetric  
 Efficiency 91 %  
 Peak intensity 0.6 cd/lm  
 LEDs/each optic 1  
 Light colour White  
 Required components:

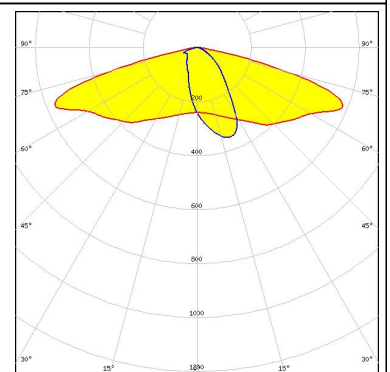

LED LUXEON 3030 2D (Round LES)  
 FWHM Asymmetric  
 Efficiency 91 %  
 Peak intensity 0.9 cd/lm  
 LEDs/each optic 1  
 Light colour White  
 Required components:

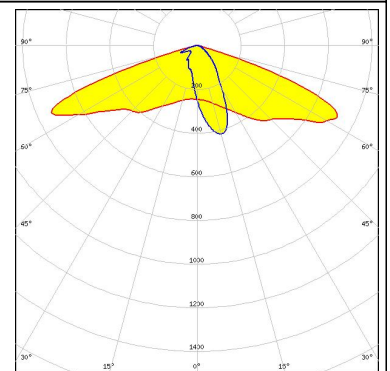

LED NF2x757G  
 FWHM Asymmetric  
 Efficiency 91 %  
 Peak intensity 0.7 cd/lm  
 LEDs/each optic 1  
 Light colour White  
 Required components:

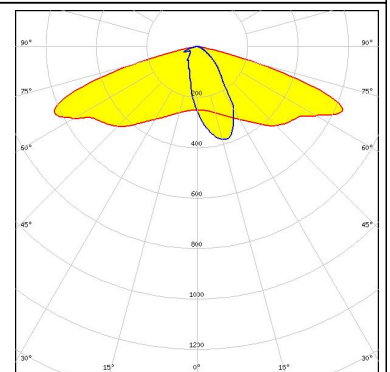

#### PHOTOMETRIC DATA (MEASURED):

#### OSRAM

Opto Semiconductors  
 LED Duris S5 (2 chip)  
 FWHM Asymmetric  
 Efficiency 92 %  
 Peak intensity 0.8 cd/lm  
 LEDs/each optic 1  
 Light colour White  
 Required components:

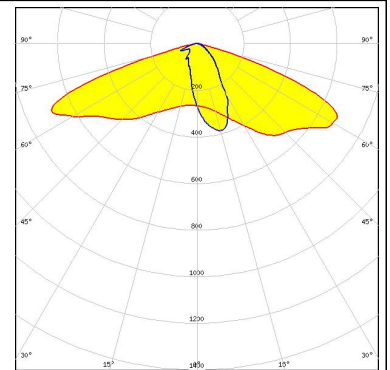

#### OSRAM

Opto Semiconductors  
 LED OSCONIQ S 3030  
 FWHM Asymmetric  
 Efficiency 92 %  
 Peak intensity 0.7 cd/lm  
 LEDs/each optic 1  
 Light colour White  
 Required components:

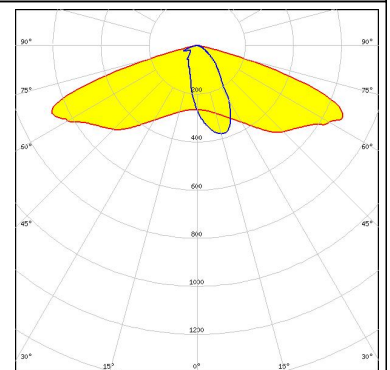

#### OSRAM

Opto Semiconductors  
 LED OSLON Square CSSRM2/CSSRM3  
 FWHM Asymmetric  
 Efficiency 92 %  
 Peak intensity 0.8 cd/lm  
 LEDs/each optic 1  
 Light colour White  
 Required components:

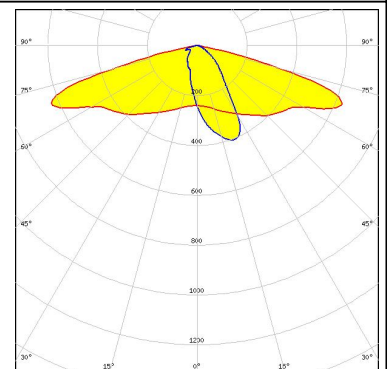

#### SAMSUNG

LED HiLOM SC28 (LH181B)  
 FWHM Asymmetric  
 Efficiency 89 %  
 Peak intensity 0.9 cd/lm  
 LEDs/each optic 1  
 Light colour White  
 Required components:

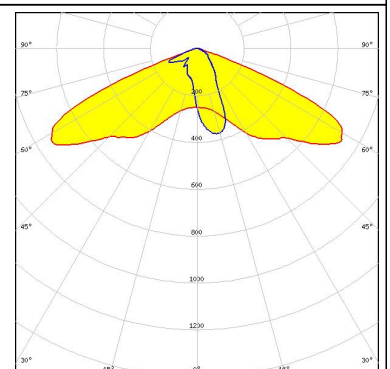

#### PHOTOMETRIC DATA (MEASURED):

#### SAMSUNG

LED HiLOM SM28 (LM301B)  
FWHM Asymmetric  
Efficiency 90 %  
Peak intensity 0.9 cd/lm  
LEDs/each optic 1  
Light colour White  
Required components:

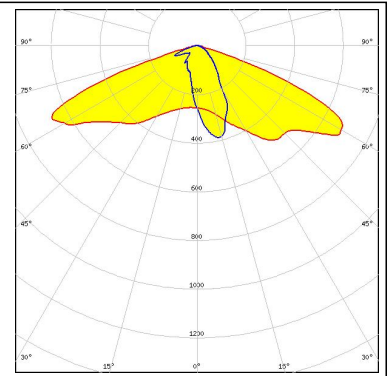



#### PHOTOMETRIC DATA (SIMULATED):



LED NF2x757G  
FWHM Asymmetric  
Efficiency 91 %  
Peak intensity 0.7 cd/lm  
LEDs/each optic 1  
Light colour White  
Required components:

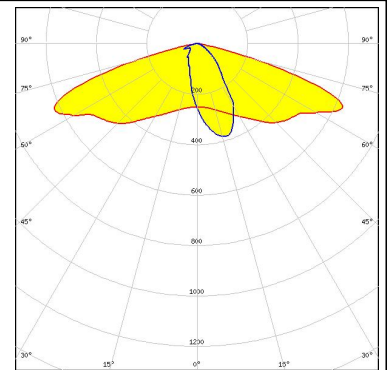

LED NVSW319B  
FWHM Asymmetric  
Efficiency 84 %  
Peak intensity 0.4 cd/lm  
LEDs/each optic 1  
Light colour White  
Required components:

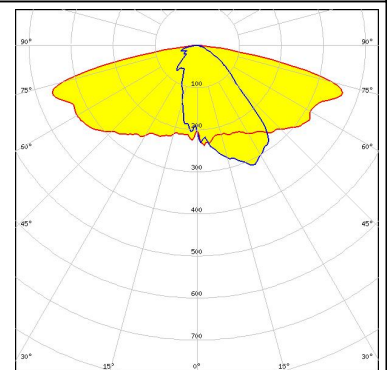

LED NVSxx19B/NVSxx19C  
FWHM Asymmetric  
Efficiency 87 %  
Peak intensity 0.5 cd/lm  
LEDs/each optic 1  
Light colour White  
Required components:

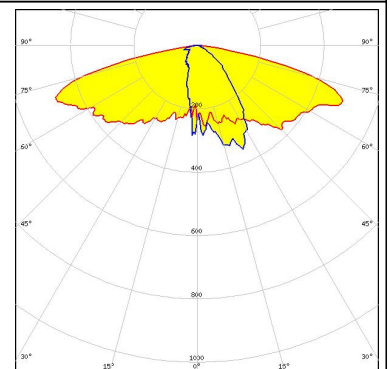

LED OSCONIQ P 3030  
FWHM Asymmetric  
Efficiency 94 %  
Peak intensity 0.7 cd/lm  
LEDs/each optic 1  
Light colour White  
Required components:

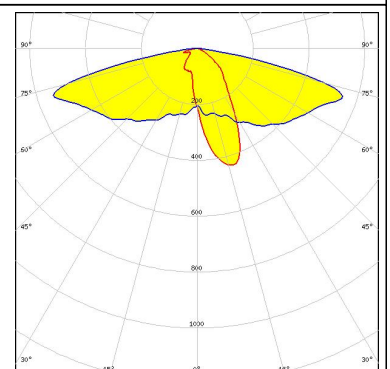



#### PHOTOMETRIC DATA (SIMULATED):

#### OSRAM

Opto Semiconductors

LED OSLON Square CSSRM2/CSSRM3  
FWHM Asymmetric  
Efficiency 93 %  
Peak intensity 0.6 cd/lm  
LEDs/each optic 1  
Light colour White  
Required components:

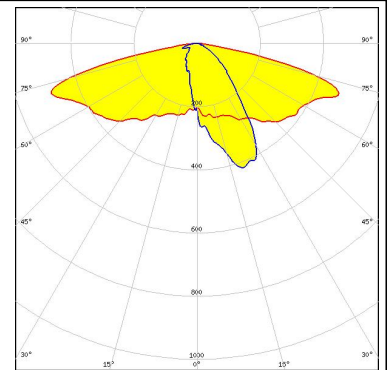

#### SAMSUNG

LED LH231B  
FWHM Asymmetric  
Efficiency 88 %  
Peak intensity 0.6 cd/lm  
LEDs/each optic 1  
Light colour White  
Required components:

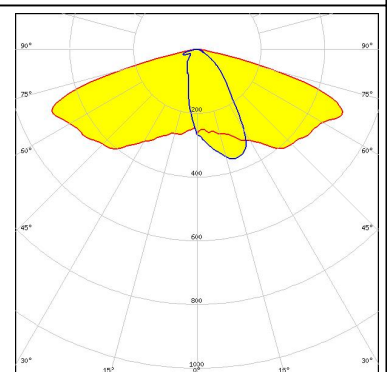

#### SAMSUNG



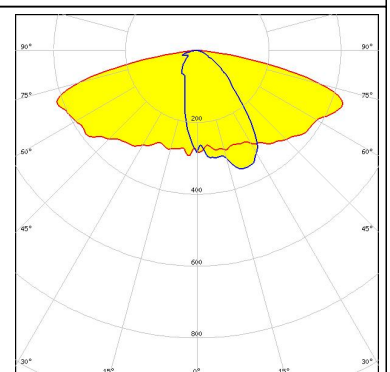

LED LH351B  
FWHM Asymmetric  
Efficiency 92 %  
Peak intensity 0.5 cd/lm  
LEDs/each optic 1  
Light colour White  
Required components:

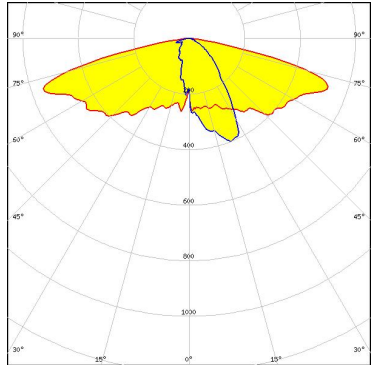

SEOUL SEMICONDUCTOR

LED SEOUL DC 3030  
FWHM Asymmetric  
Efficiency 90 %  
Peak intensity 0.6 cd/lm  
LEDs/each optic 1  
Light colour White  
Required components:

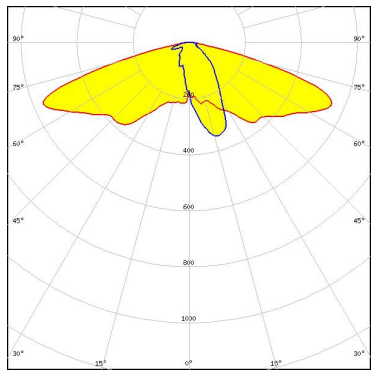
#### PHOTOMETRIC DATA (SIMULATED):

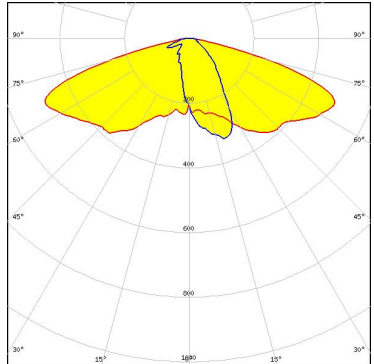
<p> SEUL SEMICONDUCTOR</p> <p>LED: Z5M1/Z5M2            FWHM: Asymmetric            Efficiency: 89 %            Peak intensity: 0.6 cd/lm            LEDs/each optic: 1            Light colour: White            Required components:</p>	
<p> SEUL SEMICONDUCTOR</p> <p>LED: Z8Y19            FWHM: Asymmetric            Efficiency: 85 %            Peak intensity: 0.7 cd/lm            LEDs/each optic: 1            Light colour: White            Required components:</p>	
<p> SEUL SEMICONDUCTOR</p> <p>LED: Z8Y22            FWHM: Asymmetric            Efficiency: 85 %            Peak intensity: 0.6 cd/lm            LEDs/each optic: 1            Light colour: White            Required components:</p>	

#### GENERAL INFORMATION:

NOTE: The typical beam angle will be changed by different color, chip size and chip position tolerance. The typical total beam angle is the full angle measured where the luminous intensity is half of the peak value.

#### MATERIALS:

As part of our continuous research and improvement processes, and to ensure the best possible quality and availability of our products, LEDiL reserves the right to change material grades without notice.

#### PRODUCT DATA USER AGREEMENT AND DISCLAIMER:

The measured data in the provided downloadable LEDiL Product Datasheets and Mechanical 2D-Drawings is rounded and provided as reference for planning. LEDiL Oy's optical specifications have been verified by conducting performance testing of the products in accordance with the company's quality system. The reported data are averaged results of multiple measurements with typical variation. LEDiL Oy reserves the right to without prior notification make changes and improvements to its products.

LEDiL Oy assumes neither warranty, nor guarantee nor any other liability of any kind for the contents and correctness of the provided data. The provided data has been generated with highest diligence but the provided data may in reality not represent the complete possible variation range of all intrinsic parameters. Therefore, in certain cases a deviation from the provided data could occur.

LEDiL Oy reserves the right to undertake technical changes of its products without further notification which could lead to changes in the provided data. LEDiL Oy assumes no liability of any kind for the possible deviation from any provided data or any other damage resulting from the usage of the provided data.

The user agrees to this disclaimer and user agreement with the download or usage of the provided files.

#### LEDiL Oy

Joensuunkatu 13  
FI-24240 SALO  
Finland

#### LEDiL Inc.

228 West Page Street  
Suite D  
Sycamore IL 60178  
USA

#### Local sales and technical support

[www.ledil.com/  
where\\_to\\_buy](http://www.ledil.com/where_to_buy)

#### Shipping locations

Salo, Finland  
Hong Kong, China

#### Distribution Partners

[www.ledil.com/  
where\\_to\\_buy](http://www.ledil.com/where_to_buy)



Компания «ЭлектроПласт» предлагает заключение долгосрочных отношений при поставках импортных электронных компонентов на взаимовыгодных условиях!

Наши преимущества:

- Оперативные поставки широкого спектра электронных компонентов отечественного и импортного производства напрямую от производителей и с крупнейших мировых складов;
- Поставка более 17-ти миллионов наименований электронных компонентов;
- Поставка сложных, дефицитных, либо снятых с производства позиций;
- Оперативные сроки поставки под заказ (от 5 рабочих дней);
- Экспресс доставка в любую точку России;
- Техническая поддержка проекта, помощь в подборе аналогов, поставка прототипов;
- Система менеджмента качества сертифицирована по Международному стандарту ISO 9001;
- Лицензия ФСБ на осуществление работ с использованием сведений, составляющих государственную тайну;
- Поставка специализированных компонентов (Xilinx, Altera, Analog Devices, Intersil, Interpoint, Microsemi, Aeroflex, Peregrine, Syfer, Eurofarad, Texas Instrument, Miteq, Cobham, E2V, MA-COM, Hittite, Mini-Circuits, General Dynamics и др.);

Помимо этого, одним из направлений компании «ЭлектроПласт» является направление «Источники питания». Мы предлагаем Вам помощь Конструкторского отдела:

- Подбор оптимального решения, техническое обоснование при выборе компонента;
- Подбор аналогов;
- Консультации по применению компонента;
- Поставка образцов и прототипов;
- Техническая поддержка проекта;
- Защита от снятия компонента с производства.



#### Как с нами связаться

**Телефон:** 8 (812) 309 58 32 (многоканальный)

**Факс:** 8 (812) 320-02-42

**Электронная почта:** [org@eplast1.ru](mailto:org@eplast1.ru)

**Адрес:** 198099, г. Санкт-Петербург, ул. Калинина, дом 2, корпус 4, литера А.