



ATTENTION
OBSERVE PRECAUTIONS
FOR HANDLING
ELECTROSTATIC
DISCHARGE
SENSITIVE
DEVICES

Part Number: AAAF5060QBFSURZGS

Blue
Hyper Red
Green

Features

- Chips can be controlled separately.
- Suitable for all SMT assembly and solder process.
- Available on tape and reel.
- Package: 500pcs / reel.
- Moisture sensitivity level : level 3.
- RoHS compliant.

Description

The Blue source color devices are made with InGaN Light Emitting Diode.

The Hyper Red source color devices are made with Al-GaN on GaAs substrate Light Emitting Diode.

The Green source color devices are made with InGaN on Sapphire Light Emitting Diode.

Static electricity and surge damage the LEDs.

It is recommended to use a wrist band or anti-electrostatic glove when handling the LEDs.

All devices, equipment and machinery must be electrically grounded.

Package Dimensions

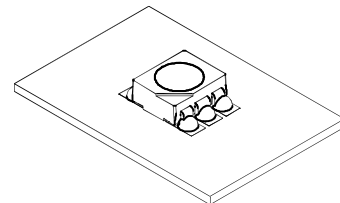
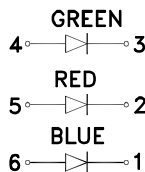
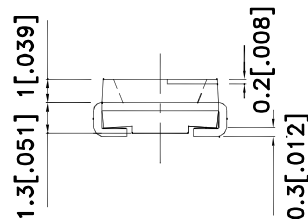
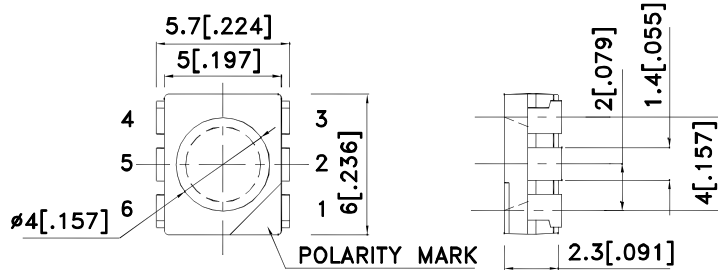

Notes:

1. All dimensions are in millimeters (inches).
2. Tolerance is $\pm 0.25(0.01)$ unless otherwise noted.
3. The specifications, characteristics and technical data described in the datasheet are subject to change without prior notice.
4. The device has a single mounting surface. The device must be mounted according to the specifications.



Handling Precautions

Compare to epoxy encapsulant that is hard and brittle, silicone is softer and flexible. Although its characteristic significantly reduces thermal stress, it is more susceptible to damage by external mechanical force.

As a result, special handling precautions need to be observed during assembly using silicone encapsulated LED products. Failure to comply might lead to damage and premature failure of the LED.

1. Handle the component along the side surfaces by using forceps or appropriate tools.

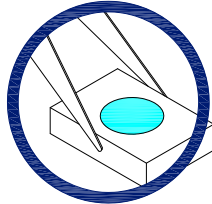

2. Do not directly touch or handle the silicone lens surface. It may damage the internal circuitry.

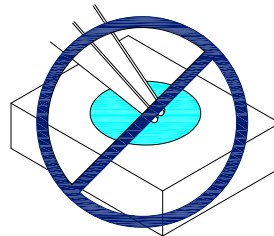
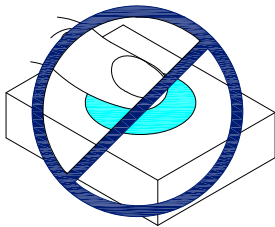

3. Do not stack together assembled PCBs containing exposed LEDs. Impact may scratch the silicone lens or damage the internal circuitry.

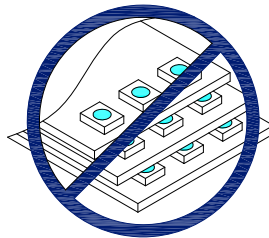

4. The outer diameter of the SMD pickup nozzle should not exceed the size of the LED to prevent air leaks. The inner diameter of the nozzle should be as large as possible.

5. A pliable material is suggested for the nozzle tip to avoid scratching or damaging the LED surface during pickup.

6. The dimensions of the component must be accurately programmed in the pick-and-place machine to insure precise pickup and avoid damage during production.

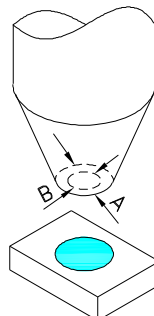

Selection Guide

Part No.	Dice	Lens Type	Iv (mcd) [2] @ 30mA *50mA		Viewing Angle [1]
			Min.	Typ.	2θ1/2
AAAF5060QBFSURZGS	Blue (InGaN)	Water Clear	280	400	100°
	Hyper Red (AlGaInP)		*500	*800	
	Green (InGaN)		500	1000	

Notes:

1. θ1/2 is the angle from optical centerline where the luminous intensity is 1/2 of the optical peak value.
2. *Luminous intensity with asterisk is measured at 50mA; Luminous intensity/ luminous Flux: +/-15%.

Electrical / Optical Characteristics at TA=25°C

Symbol	Parameter	Device	Typ.	Max.	Units	Test Conditions
λ_{peak}	Peak Wavelength	Blue Hyper Red Green	461 650 515		nm	I _F =20mA
λ_D [1]	Dominant Wavelength	Blue Hyper Red Green	465 630 525		nm	I _F =20mA
$\Delta\lambda_{1/2}$	Spectral Line Half-width	Blue Hyper Red Green	25 27 30		nm	I _F =20mA
C	Capacitance	Blue Hyper Red Green	100 45 45		pF	V _F =0V;f=1MHz
V _F [2]	Forward Voltage	Blue Hyper Red Green	3.3 1.9 3.3	4 2.5 4.1	V	I _F =20mA
I _R	Reverse Current	Blue Hyper Red Green		50 10 50	uA	V _R =5V

Notes:

1. Wavelength: +/-1nm.
2. Forward Voltage: +/-0.1V.

Absolute Maximum Ratings at TA=25°C

Parameter	Blue	Hyper Red	Green	Units
Power dissipation[2]	350			mW
DC Forward Current	30	50	30	mA
Peak Forward Current [1]	150	185	150	mA
Reverse Voltage	5			V
Operating Temperature	-40°C To +85°C			
Storage Temperature	-40°C To +85°C			

Notes:

1. 1/10 Duty Cycle, 0.1ms Pulse Width.
2. Within 350mW at all chips are lightened.

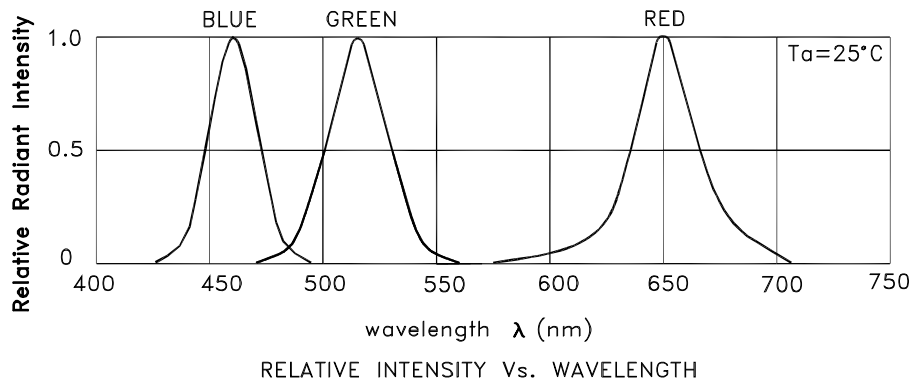

AAAF5060QBFSURZGS Blue

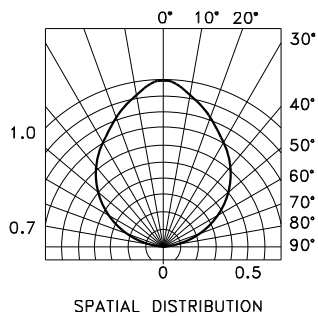
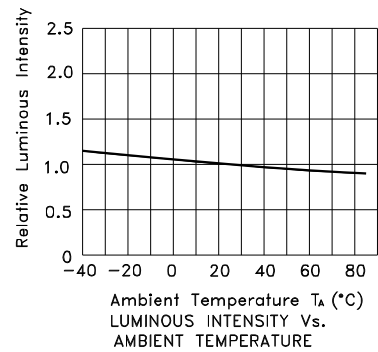
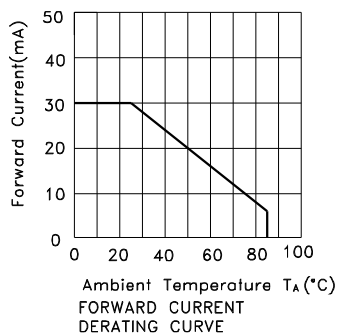
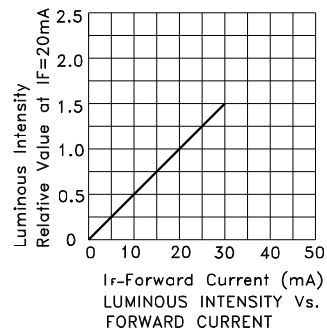
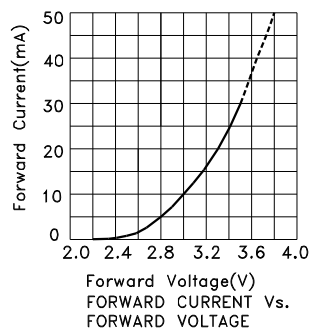

Kingbright

Hyper Red

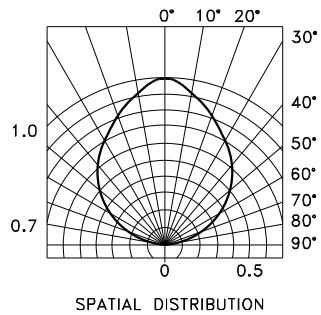
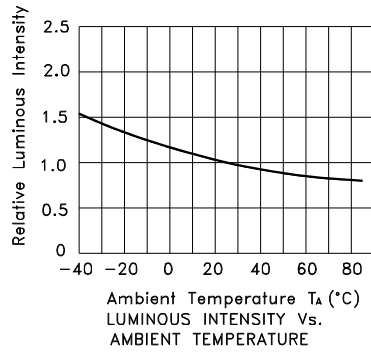
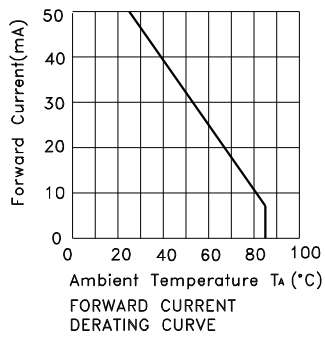
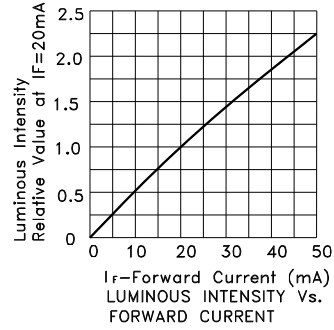
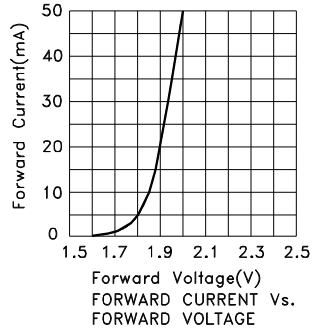

Green

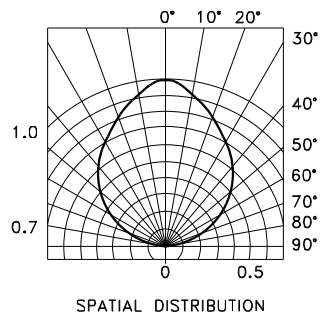
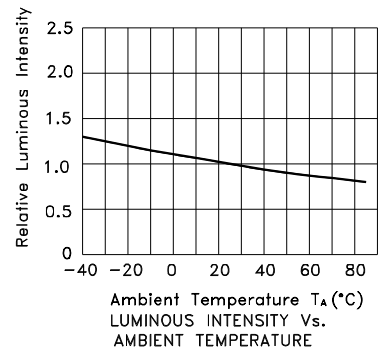
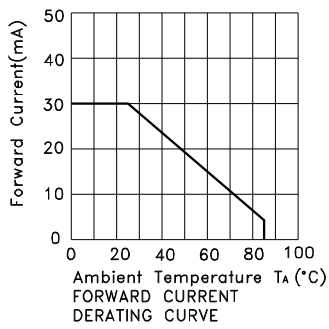
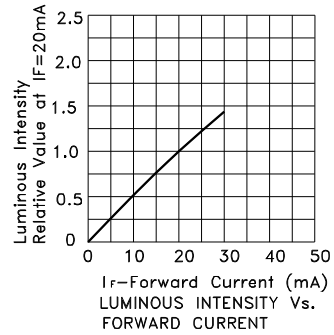
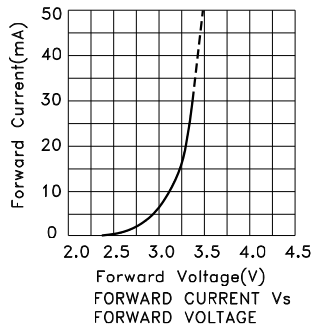

AAAF5060QBFSURZGS

Reflow soldering is recommended and the soldering profile is shown below.
Other soldering methods are not recommended as they might cause damage to the product.

Reflow Soldering Profile For Lead-free SMT Process.

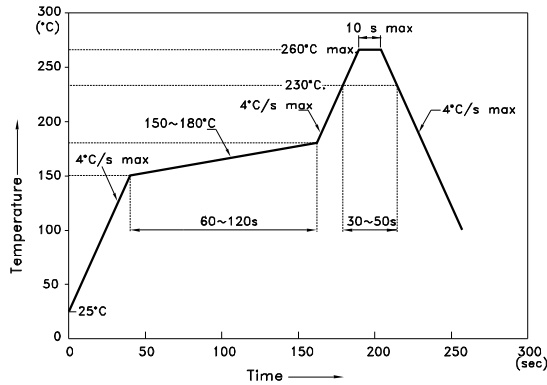

NOTES:

1. We recommend the reflow temperature 245°C(+/-5°C). The maximum soldering temperature should be limited to 260°C.
2. Don't cause stress to the epoxy resin while it is exposed to high temperature.
3. Number of reflow process shall be 2 times or less.

Recommended Soldering Pattern (Units : mm; Tolerance: ± 0.1)

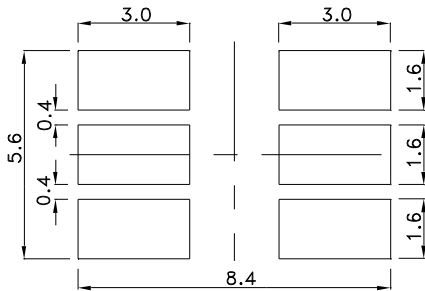

Reel Dimension

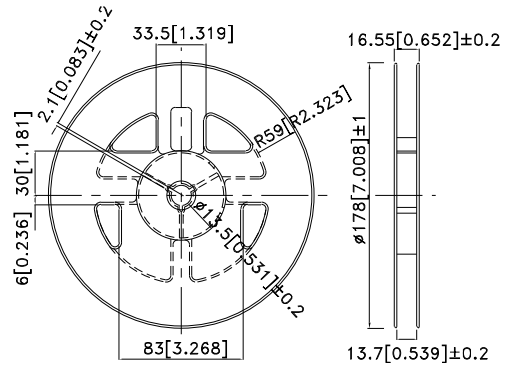

Tape Dimensions (Units : mm)

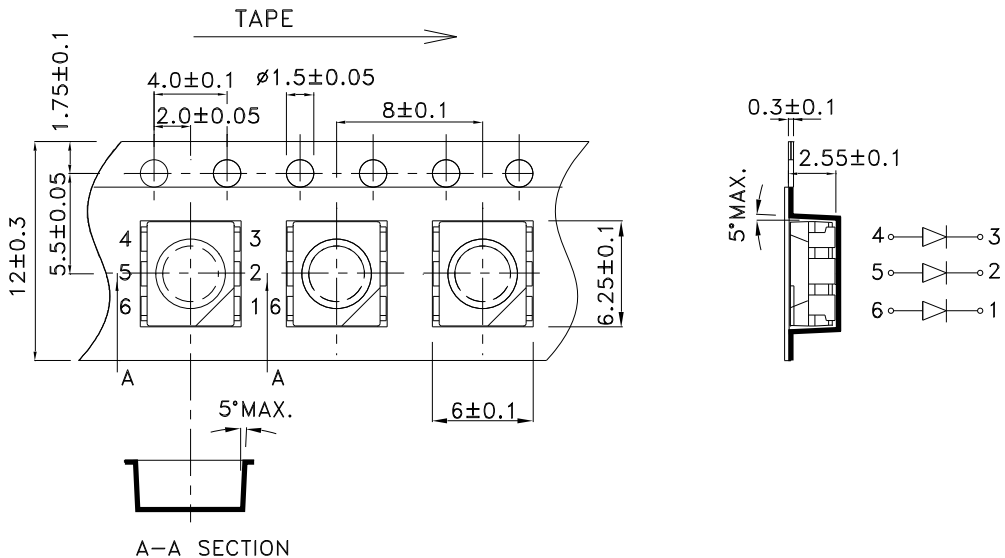

Kingbright

PACKING & LABEL SPECIFICATIONS

AAAF5060QBFSURZGS

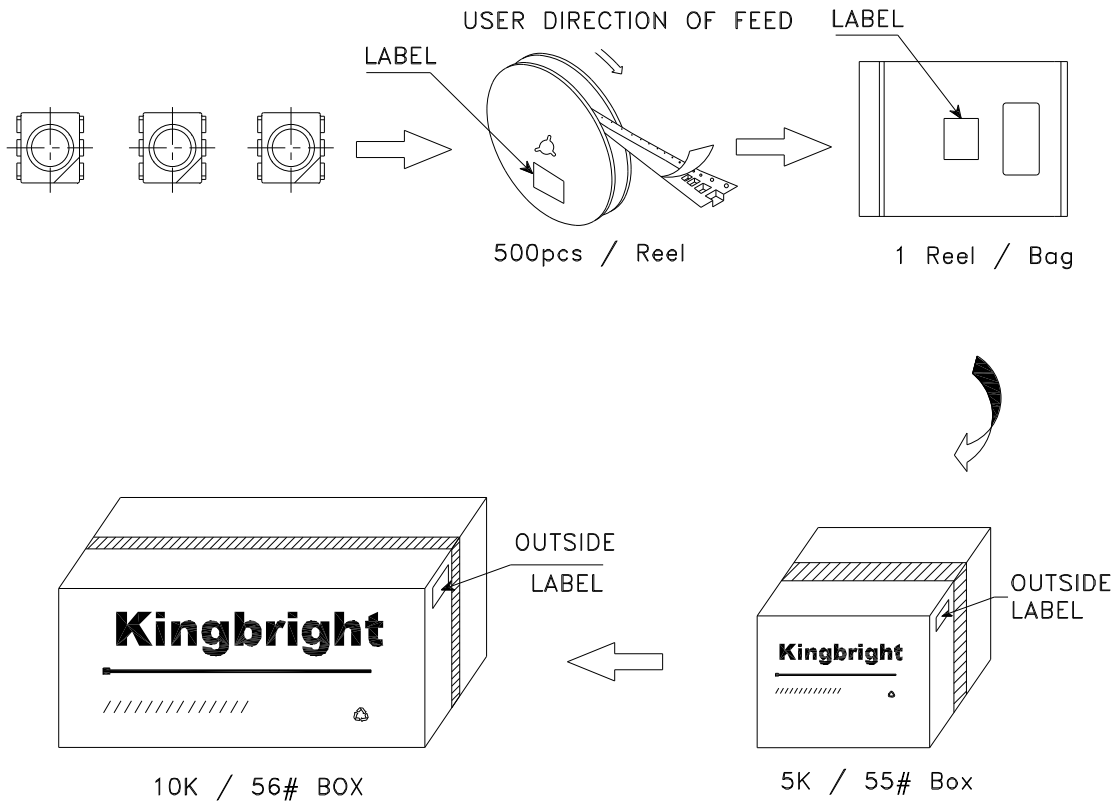

<h1>Kingbright</h1>	
P/NO: AAAF5060xxx	
QTY: 500 pcs	Q.C. Q C xx xx xxxx PASSED
S/N: XXXX	
CODE: XXX	
LOT NO:	
 <small>xxxxxxxxxxxxxxxxxxxxxxxxxxxxxxxx</small>	
RoHS Compliant	



Компания «ЭлектроПласт» предлагает заключение долгосрочных отношений при поставках импортных электронных компонентов на взаимовыгодных условиях!

Наши преимущества:

- Оперативные поставки широкого спектра электронных компонентов отечественного и импортного производства напрямую от производителей и с крупнейших мировых складов;
- Поставка более 17-ти миллионов наименований электронных компонентов;
- Поставка сложных, дефицитных, либо снятых с производства позиций;
- Оперативные сроки поставки под заказ (от 5 рабочих дней);
- Экспресс доставка в любую точку России;
- Техническая поддержка проекта, помощь в подборе аналогов, поставка прототипов;
- Система менеджмента качества сертифицирована по Международному стандарту ISO 9001;
- Лицензия ФСБ на осуществление работ с использованием сведений, составляющих государственную тайну;
- Поставка специализированных компонентов (Xilinx, Altera, Analog Devices, Intersil, Interpoint, Microsemi, Aeroflex, Peregrine, Syfer, Eurofarad, Texas Instrument, Miteq, Cobham, E2V, MA-COM, Hittite, Mini-Circuits, General Dynamics и др.);

Помимо этого, одним из направлений компании «ЭлектроПласт» является направление «Источники питания». Мы предлагаем Вам помощь Конструкторского отдела:

- Подбор оптимального решения, техническое обоснование при выборе компонента;
- Подбор аналогов;
- Консультации по применению компонента;
- Поставка образцов и прототипов;
- Техническая поддержка проекта;
- Защита от снятия компонента с производства.



Как с нами связаться

Телефон: 8 (812) 309 58 32 (многоканальный)

Факс: 8 (812) 320-02-42

Электронная почта: org@eplast1.ru

Адрес: 198099, г. Санкт-Петербург, ул. Калинина, дом 2, корпус 4, литера А.