

**PLEASE CHECK WWW.MOLEX.COM FOR LATEST PART INFORMATION**

**Part Number:** [0459713215](#)  
**Status:** **Active**  
**Description:** 1.27mm (.050") by 1.27mm (.050") Pitch SEARAY\* Receptacle, 300 Circuits, 6.00mm (.236") Unmated Height, 10 Rows, With Pegs, Solder Charge™ Lead Free

**Documents:**

<a href="#">3D Model</a>	<a href="#">Product Specification PS-45970-002 (PDF)</a>
<a href="#">Drawing (PDF)</a>	<a href="#">RoHS Certificate of Compliance (PDF)</a>
<a href="#">Product Specification PS-45970-001 (PDF)</a>	

**Agency Certification**

CSA	LR19980
UL	E29179

**General**

Product Family	PCB Receptacles
Series	<a href="#">45971</a>
Application	Board-to-Board
Product Name	SEARAY*

**Physical**

Circuits (Loaded)	300
Circuits (maximum)	300
Circuits Detail	300
Color - Resin	Black
Durability (mating cycles max)	100
Flammability	94V-0
Glow-Wire Compliant	No
Guide to Mating Part	No
Keying to Mating Part	None
Lock to Mating Part	No
Material - Metal	Copper Alloy
Material - Plating Mating	Gold
Material - Plating Termination	Tin
Material - Resin	High Temperature Thermoplastic
Number of Rows	10
Orientation	Vertical
PC Tail Length (in)	0.086 In
PC Tail Length (mm)	2.18 mm
PCB Locator	Yes
PCB Retention	Yes
PCB Thickness Recommended (in)	0.062 In
PCB Thickness Recommended (mm)	1.57 mm
Packaging Type	Embossed Tape on Reel
Pitch - Mating Interface (in)	0.050 In
Pitch - Mating Interface (mm)	1.27 mm
Pitch - Term. Interface (in)	0.050 In
Pitch - Term. Interface (mm)	1.27 mm
Plating min: Mating (µin)	30
Plating min: Mating (µm)	0.75
Plating min: Termination (µin)	100
Plating min: Termination (µm)	2.5
Polarized to Mating Part	Yes
Polarized to PCB	Yes
Robotic Placement	Pick and Place Cap
Stackable	No

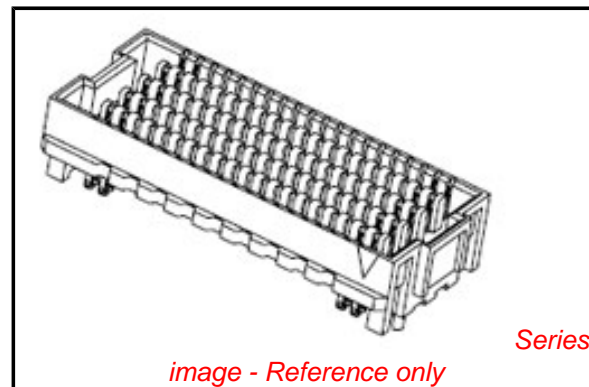

**EU RoHS**

**ELV and RoHS Compliant**  
**REACH SVHC**  
 Not Reviewed  
**Halogen-Free Status**  
 Not Reviewed

**China RoHS**



**Need more information on product environmental compliance?**

Email [productcompliance@molex.com](mailto:productcompliance@molex.com)  
 For a multiple part number RoHS Certificate of Compliance, [click here](#)

Please visit the [Contact Us](#) section for any non-product compliance questions.

**Search Parts in this Series**

[45971Series](#)

**Mates With**

[45970 SEARAY\\* Plug](#)

Surface Mount Compatible (SMC)	Yes
Temperature Range - Operating	-55°C to +125°C
Termination Interface: Style	Surface Mount

### **Electrical**

Current - Maximum per Contact	2.7A
Grounding to PCB	No
Voltage - Maximum	240V AC

### **Solder Process Data**

Duration at Max. Process Temperature (seconds)	3
Lead-free Process Capability	Reflow Capable (SMT only)
Max. Cycles at Max. Process Temperature	1
Process Temperature max. C	260

### **Material Info**

#### **Reference - Drawing Numbers**

Application Specification	AS-45970-001, AS-45970-002, AS-45970-990
Packaging Specification	PK-45971-001, PK-45971-002
Product Specification	PS-45970-001, PS-45970-002
Sales Drawing	SD-45971-001
Test Summary	TS-45970-001

\*SEARAY is a trademark of Samtec, Inc.

This document was generated on 05/25/2010

**PLEASE CHECK [WWW.MOLEX.COM](http://WWW.MOLEX.COM) FOR LATEST PART INFORMATION**

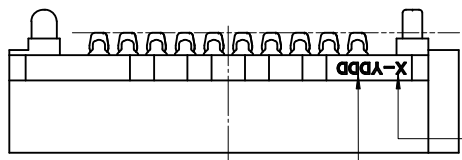

$\overline{\text{A}} .006$  ACROSS ALL SOLDER CHARGES

LEAD CODE:  
1 = TIN  
2 = TIN / LEAD

DATE CODE

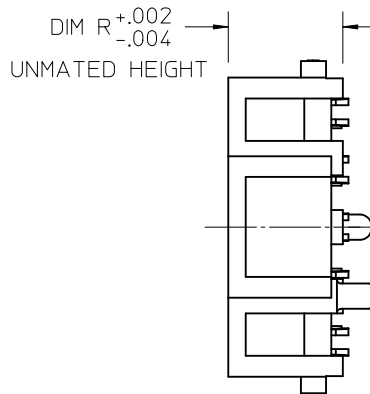
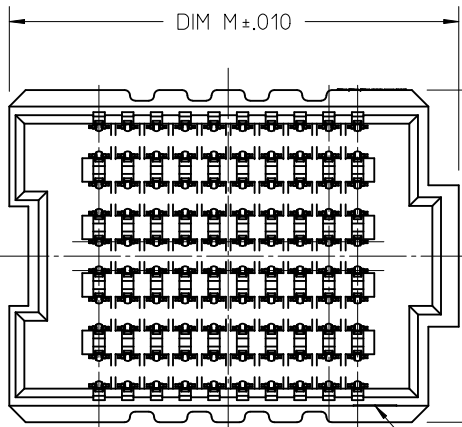
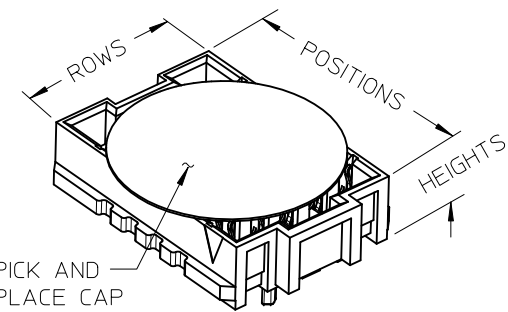

ROW 1 / POSITION 1 ID THIS SIDE

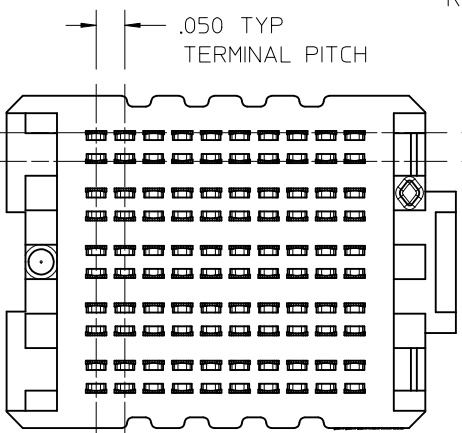

NOTES:

- MATERIALS: HOUSING: LCP, UL94V-0, BLACK  
CONTACTS: COPPER ALLOY  
SOLDER CHARGE: SEE CHART
- FINISH: ALL OPTIONS - SELECT GOLD IN CONTACT AREA: 30 MI MIN  
OPTIONS 5.0: SELECT GOLD FLASH IN TAIL, 7 MI MIN  
OPTIONS 6.0 THRU 8.0: SELECT TIN IN TAIL, 100 MI MIN  
ALL OPTIONS - OVER NICKEL
- PRODUCT SPECIFICATION: PS-45970-001
- PACKAGING SPECIFICATION: SEE CHART
- MATES WITH SEARAY PLUG ASSEMBLY 45970
- APPLICATION SPECIFICATION: AS-45970-001
- COSMETIC SPECIFICATION: PS-45499-002 CLASS B
- PART STATUS: CONTACT MOLEX

UPDATED NOTE 2 EC NO: UCP2010-2270 DRWN: TGREGOR I 2010/03/05 CHKD: JCOMERC I 2005/05/17 APPR: JCOMERC I 2010/03/05	DESCRIPTION REV	GENERAL TOLERANCES (UNLESS SPECIFIED)		DIMENSION STYLE <b>INCH ONLY</b>		SCALE <b>3:1</b>	DESIGN UNITS <b>INCH</b>	THIRD ANGLE PROJECTION	
		4 PLACES ± --- ± ---	mm INCH	DRAWN BY TGREGOR I	DATE 2005/05/17	TITLE <b>SEARAY RECEPTACLE ASSEMBLY .050 CENTERS</b>			
		3 PLACES ± --- ± .005	mm INCH	CHECKED BY JCOMERC I	DATE 2005/05/17				
		2 PLACES ± --- ± ---	mm INCH	APPROVED BY JCOMERC I	DATE 2010/03/05	<b>MOLEX INCORPORATED</b>			
1 PLACE ± --- ± ---	mm INCH	MATERIAL NO. SEE CHART	DOCUMENT NO. <b>SD-45971-001</b>	SHEET NO. <b>1 OF 10</b>					
DRAFT WHERE APPLICABLE MUST REMAIN WITHIN DIMENSIONS		ANGULAR ± ---°		THIS DRAWING CONTAINS INFORMATION THAT IS PROPRIETARY TO MOLEX INCORPORATED AND SHOULD NOT BE USED WITHOUT WRITTEN PERMISSION					

6

5

4

3

2

1

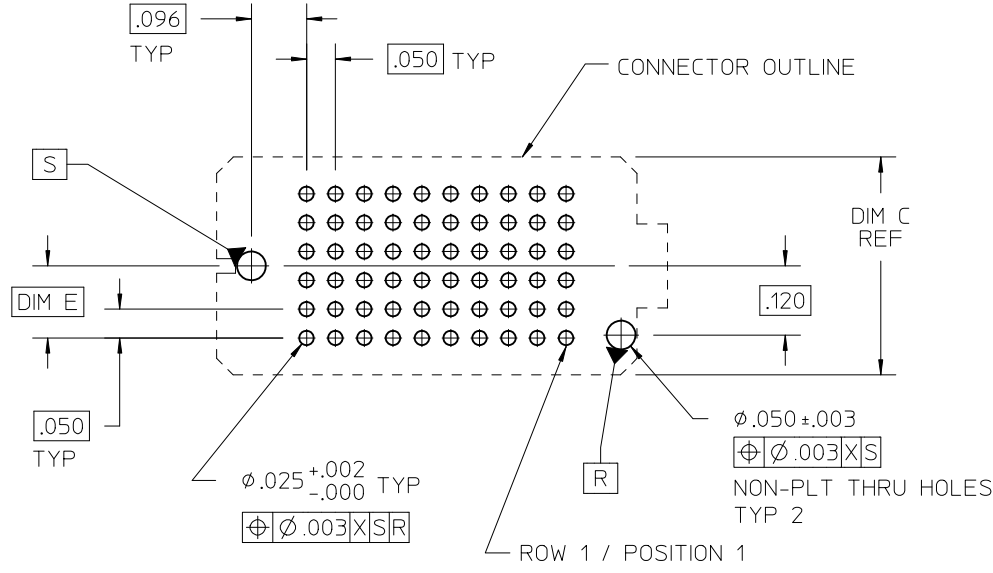

**F**  
 .005  
 MIN SOLDER  
 PASTE THICKNESS

NO OF ROWS	DIM C	DIM E
6	.378	.125
8	.478	.175
10	.578	.225
12	.678	.275

RECOMMENDED PCB LAYOUT: COMPONENT SIDE  
 SOLDER SCREEN APERTURE SIZE: .035  
 PCB THICKNESS: NA



DIM P PLUG STACK HEIGHT	DIM R RECEPTACLE STACK HEIGHT					
	MM	5.0	6.0	6.5	7.5	8.0
2.0	7.0	8.0	8.5	9.5	10.0	
3.0	8.0	9.0	9.5	10.5	11.0	
3.5	8.5	9.5	10.0	11.0	11.5	
2.5	7.5	8.5	9.0	10.0	10.5	
4.5	9.5	10.5	11.0	12.0	12.5	
5.0	10.0	11.0	11.5	12.5	13.0	
7.0	12.0	13.0	13.5	14.5	15.0	

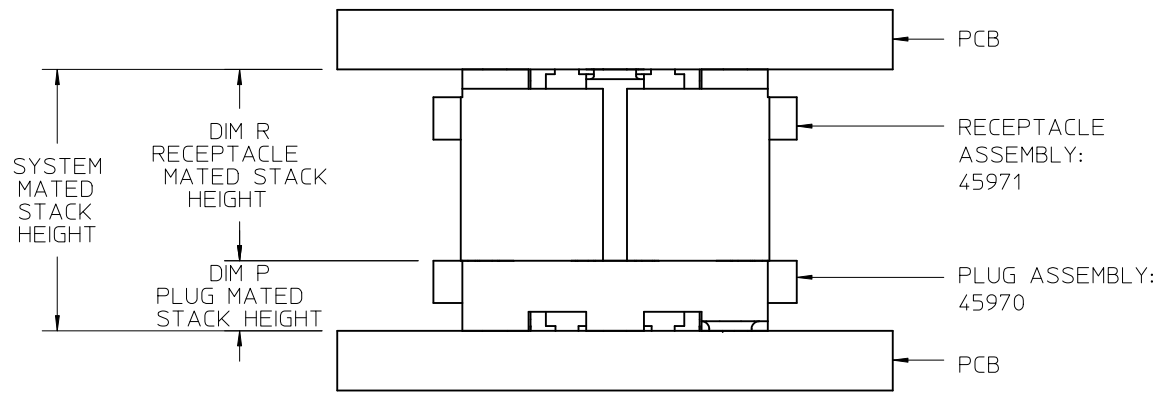

STACK HEIGHTS GIVEN IN METRIC FOR REF ONLY

MATED STACK HEIGHTS  
 (MILLIMETERS) REF

SEE SHEET 1 EC NO: UCP2010-2270 DRWN: TGREGORI 2010/03/05 CHKD: JCOMERCI 2005/05/17 APPR: JCOMERCI 2010/03/05	REV	DESCRIPTION
	0	

GENERAL TOLERANCES (UNLESS SPECIFIED)		
	mm	INCH
4 PLACES	± .005	± .0005
3 PLACES	± .005	± .0005
2 PLACES	± .005	± .0005
1 PLACE	± .005	± .0005
ANGULAR ± .005°		
DRAFT WHERE APPLICABLE MUST REMAIN WITHIN DIMENSIONS		

DIMENSION STYLE INCH ONLY	
DRAWN BY	DATE
TGREGORI	2005/05/17
CHECKED BY	DATE
JCOMERCI	2005/05/17
APPROVED BY	DATE
JCOMERCI	2010/03/05
MATERIAL NO.	
SEE CHARTS	

SCALE 3:1	DESIGN UNITS INCH	THIRD ANGLE PROJECTION
TITLE SEARAY RECEPTACLE ASSEMBLY .050 CENTERS		
molex MOLEX INCORPORATED		
DOCUMENT NO. SD-45971-001	SHEET NO. 2 OF 10	

5

4

3

2

1

6		5		4		3		2		1		
DIM R: (REF)		5.0 MM		6.0 MM		6.5 MM		7.5 MM		8.0 MM		STACK HEIGHTS GIVEN IN METRIC FOR REF ONLY
DIM R: HOUSING HEIGHT												
		.199		.238		.258		.297		.297		
POSITION	DIM M	MATERIAL NO	MATERIAL NO	MATERIAL NO	MATERIAL NO	MATERIAL NO	MATERIAL NO	MATERIAL NO	MATERIAL NO	MATERIAL NO		
19	1.232	45971-0161	45971-0261	45971-0361	45971-0461	45971-0561	45971-0661	45971-0761	45971-0861	45971-0961		
10	0.782	45971-1161	45971-1261	45971-1361	45971-1461	45971-1561	45971-1661	45971-1761	45971-1861	45971-1961		
20	1.282	45971-2161	45971-2261	45971-2361	45971-2461	45971-2561	45971-2661	45971-2761	45971-2861	45971-2961		
30	1.782	45971-3161	45971-3261	45971-3361	45971-3461	45971-3561	45971-3661	45971-3761	45971-3861	45971-3961		
40	2.282	45971-4161	45971-4261	45971-4361	45971-4461	45971-4561	45971-4661	45971-4761	45971-4861	45971-4961		
50	2.782	45971-5161	45971-5261	45971-5361	45971-5461	45971-5561	45971-5661	45971-5761	45971-5861	45971-5961		
15	1.032	45971-6161	45971-6261	45971-6361	45971-6461	45971-6561	45971-6661	45971-6761	45971-6861	45971-6961		
25	1.532	45971-7161	45971-7261	45971-7361	45971-7461	45971-7561	45971-7661	45971-7761	45971-7861	45971-7961		
35	2.032	45971-8161	45971-8261	45971-8361	45971-8461	45971-8561	45971-8661	45971-8761	45971-8861	45971-8961		
45	2.532	45971-9161	45971-9261	45971-9361	45971-9461	45971-9561	45971-9661	45971-9761	45971-9861	45971-9961		

6		5		4		3		2		1		
DIM R: (REF)		5.0 MM		6.0 MM		6.5 MM		7.5 MM		8.0 MM		STACK HEIGHTS GIVEN IN METRIC FOR REF ONLY
DIM R: HOUSING HEIGHT												
		.199		.238		.258		.297		.297		
POSITION	DIM M	MATERIAL NO	MATERIAL NO	MATERIAL NO	MATERIAL NO	MATERIAL NO	MATERIAL NO	MATERIAL NO	MATERIAL NO	MATERIAL NO		
19	1.232	45971-0165	45971-0265	45971-0365	45971-0465	45971-0565	45971-0665	45971-0765	45971-0865	45971-0965		
10	0.782	45971-1165	45971-1265	45971-1365	45971-1465	45971-1565	45971-1665	45971-1765	45971-1865	45971-1965		
20	1.282	45971-2165	45971-2265	45971-2365	45971-2465	45971-2565	45971-2665	45971-2765	45971-2865	45971-2965		
30	1.782	45971-3165	45971-3265	45971-3365	45971-3465	45971-3565	45971-3665	45971-3765	45971-3865	45971-3965		
40	2.282	45971-4165	45971-4265	45971-4365	45971-4465	45971-4565	45971-4665	45971-4765	45971-4865	45971-4965		
50	2.782	45971-5165	45971-5265	45971-5365	45971-5465	45971-5565	45971-5665	45971-5765	45971-5865	45971-5965		
15	1.032	45971-6165	45971-6265	45971-6365	45971-6465	45971-6565	45971-6665	45971-6765	45971-6865	45971-6965		
25	1.532	45971-7165	45971-7265	45971-7365	45971-7465	45971-7565	45971-7665	45971-7765	45971-7865	45971-7965		
35	2.032	45971-8165	45971-8265	45971-8365	45971-8465	45971-8565	45971-8665	45971-8765	45971-8865	45971-8965		
45	2.532	45971-9165	45971-9265	45971-9365	45971-9465	45971-9565	45971-9665	45971-9765	45971-9865	45971-9965		

NOTES:  
 1. THIS SHEET CONTAINS THE FOLLOWING OPTIONS  
 NO OF ROWS: 6  
 SOLDER CHARGE: TIN  
 PACKAGING: TRAYS AND TAPE AND REEL

SEE SHEET 1 EC NO: UCP2010-2270 DRWN: TGREGORI 2010/03/05 CH'KD: JCOMERCI 2005/05/17 APPR: JCOMERCI 2010/03/05	DESCRIPTION REV	GENERAL TOLERANCES (UNLESS SPECIFIED)		DIMENSION STYLE <b>INCH ONLY</b>		SCALE <b>1:1</b>	DESIGN UNITS <b>INCH</b>	THIRD ANGLE PROJECTION		
			mm	INCH	DRAWN BY TGREGORI	DATE 2005/05/17	TITLE <b>SEARAY RECEPTACLE ASSEMBLY .050 CENTERS</b>			
		4 PLACES	± ---	± ---	CHECKED BY JCOMERCI	DATE 2005/05/17				
		3 PLACES	± ---	± .005	APPROVED BY JCOMERCI	DATE 2010/03/05	 <b>MOLEX INCORPORATED</b> DOCUMENT NO. <b>SD-45971-001</b>			
		2 PLACES	± ---	± ---	MATERIAL NO.					
1 PLACE	± ---	± ---	<b>SEE CHART</b> THIS DRAWING CONTAINS INFORMATION THAT IS PROPRIETARY TO MOLEX INCORPORATED AND SHOULD NOT BE USED WITHOUT WRITTEN PERMISSION		SHEET NO. 3 OF 10					
DRAFT WHERE APPLICABLE MUST REMAIN WITHIN DIMENSIONS		ANGULAR ± ---°								

6		5		4		3	
DIM R: (REF)		5.0 MM		6.0 MM		8.0 MM	
DIM R: HOUSING HEIGHT							
POSITION		MATERIAL NO		MATERIAL NO		MATERIAL NO	
19	1.232	45971-0163	45971-0263	45971-0363	45971-0463	45971-0563	
10	0.782	45971-1163	45971-1263	45971-1363	45971-1463	45971-1563	
20	1.282	45971-2163	45971-2263	45971-2363	45971-2463	45971-2563	
30	1.782	45971-3163	45971-3263	45971-3363	45971-3463	45971-3563	
40	2.282	45971-4163	45971-4263	45971-4363	45971-4463	45971-4563	
50	2.782	45971-5163	45971-5263	45971-5363	45971-5463	45971-5563	
15	1.032	45971-6163	45971-6263	45971-6363	45971-6463	45971-6563	
25	1.532	45971-7163	45971-7263	45971-7363	45971-7463	45971-7563	
35	2.032	45971-8163	45971-8263	45971-8363	45971-8463	45971-8563	
45	2.532	45971-9163	45971-9263	45971-9363	45971-9463	45971-9563	

STACK HEIGHTS GIVEN IN METRIC FOR REF ONLY

6		5		4		3	
DIM R: (REF)		5.0 MM		6.0 MM		8.0 MM	
DIM R: HOUSING HEIGHT							
POSITION		MATERIAL NO		MATERIAL NO		MATERIAL NO	
19	1.232	45971-0167	45971-0267	45971-0367	45971-0467	45971-0567	
10	0.782	45971-1167	45971-1267	45971-1367	45971-1467	45971-1567	
20	1.282	45971-2167	45971-2267	45971-2367	45971-2467	45971-2567	
30	1.782	45971-3167	45971-3267	45971-3367	45971-3467	45971-3567	
40	2.282	45971-4167	45971-4267	45971-4367	45971-4467	45971-4567	
50	2.782	45971-5167	45971-5267	45971-5367	45971-5467	45971-5567	
15	1.032	45971-6167	45971-6267	45971-6367	45971-6467	45971-6567	
25	1.532	45971-7167	45971-7267	45971-7367	45971-7467	45971-7567	
35	2.032	45971-8167	45971-8267	45971-8367	45971-8467	45971-8567	
45	2.532	45971-9167	45971-9267	45971-9367	45971-9467	45971-9567	

STACK HEIGHTS GIVEN IN METRIC FOR REF ONLY

NOTES:  
1. THIS SHEET CONTAINS THE FOLLOWING OPTIONS  
NO OF ROWS: 6  
SOLDER CHARGE: TIN / LEAD  
PACKAGING: TRAYS AND TAPE AND REEL

SEE SHEET 1 EC NO: UCP2010-2270 DRWN: TGREGORI 2010/03/05 CHKD: JCOMERCI 2005/05/17 APPR: JCOMERCI 2010/03/05	DESCRIPTION REV	GENERAL TOLERANCES (UNLESS SPECIFIED)		DIMENSION STYLE <b>INCH ONLY</b>		SCALE <b>1:1</b>	DESIGN UNITS <b>INCH</b>	THIRD ANGLE PROJECTION	
		4 PLACES	± ---	± ---	DRAWN BY TGREGORI	DATE 2005/05/17	TITLE <b>SEARAY RECEPTACLE ASSEMBLY .050 CENTERS</b>   <b>MOLEX INCORPORATED</b>		
		3 PLACES	± ---	± .005	CHECKED BY JCOMERCI	DATE 2005/05/17			
		2 PLACES	± ---	± ---	APPROVED BY JCOMERCI	DATE 2010/03/05			
1 PLACE	± ---	± ---	MATERIAL NO.						
ANGULAR ± ---°			DRAFT WHERE APPLICABLE MUST REMAIN WITHIN DIMENSIONS		<b>SEE CHART</b>		DOCUMENT NO. <b>SD-45971-001</b>	SHEET NO. 4 OF 10	
THIS DRAWING CONTAINS INFORMATION THAT IS PROPRIETARY TO MOLEX INCORPORATED AND SHOULD NOT BE USED WITHOUT WRITTEN PERMISSION									

6		5		4		3		2		1		
DIM R: (REF)		5.0 MM		6.0 MM		6.5 MM		7.5 MM		8.0 MM		STACK HEIGHTS GIVEN IN METRIC FOR REF ONLY
DIM R: HOUSING HEIGHT												
		.199		.238		.258		.297		.297		
POSITION	DIM M	MATERIAL NO	MATERIAL NO	MATERIAL NO	MATERIAL NO	MATERIAL NO	MATERIAL NO	MATERIAL NO	MATERIAL NO	MATERIAL NO	MATERIAL NO	
19	1.232	45971-0181	45971-0281	45971-0381	45971-0481	45971-0581	45971-0681	45971-0781	45971-0881	45971-0981	45971-1081	
10	0.782	45971-1181	45971-1281	45971-1381	45971-1481	45971-1581	45971-1681	45971-1781	45971-1881	45971-1981	45971-2081	
20	1.282	45971-2181	45971-2281	45971-2381	45971-2481	45971-2581	45971-2681	45971-2781	45971-2881	45971-2981	45971-3081	
30	1.782	45971-3181	45971-3281	45971-3381	45971-3481	45971-3581	45971-3681	45971-3781	45971-3881	45971-3981	45971-4081	
40	2.282	45971-4181	45971-4281	45971-4381	45971-4481	45971-4581	45971-4681	45971-4781	45971-4881	45971-4981	45971-5081	
50	2.782	45971-5181	45971-5281	45971-5381	45971-5481	45971-5581	45971-5681	45971-5781	45971-5881	45971-5981	45971-6081	
15	1.032	45971-6181	45971-6281	45971-6381	45971-6481	45971-6581	45971-6681	45971-6781	45971-6881	45971-6981	45971-7081	
25	1.532	45971-7181	45971-7281	45971-7381	45971-7481	45971-7581	45971-7681	45971-7781	45971-7881	45971-7981	45971-8081	
35	2.032	45971-8181	45971-8281	45971-8381	45971-8481	45971-8581	45971-8681	45971-8781	45971-8881	45971-8981	45971-9081	
45	2.532	45971-9181	45971-9281	45971-9381	45971-9481	45971-9581	45971-9681	45971-9781	45971-9881	45971-9981	45971-10081	

6		5		4		3		2		1		
DIM R: (REF)		5.0 MM		6.0 MM		6.5 MM		7.5 MM		8.0 MM		STACK HEIGHTS GIVEN IN METRIC FOR REF ONLY
DIM R: HOUSING HEIGHT												
		.199		.238		.258		.297		.297		
POSITION	DIM M	MATERIAL NO	MATERIAL NO	MATERIAL NO	MATERIAL NO	MATERIAL NO	MATERIAL NO	MATERIAL NO	MATERIAL NO	MATERIAL NO	MATERIAL NO	
19	1.232	45971-0185	45971-0285	45971-0385	45971-0485	45971-0585	45971-0685	45971-0785	45971-0885	45971-0985	45971-1085	
10	0.782	45971-1185	45971-1285	45971-1385	45971-1485	45971-1585	45971-1685	45971-1785	45971-1885	45971-1985	45971-2085	
20	1.282	45971-2185	45971-2285	45971-2385	45971-2485	45971-2585	45971-2685	45971-2785	45971-2885	45971-2985	45971-3085	
30	1.782	45971-3185	45971-3285	45971-3385	45971-3485	45971-3585	45971-3685	45971-3785	45971-3885	45971-3985	45971-4085	
40	2.282	45971-4185	45971-4285	45971-4385	45971-4485	45971-4585	45971-4685	45971-4785	45971-4885	45971-4985	45971-5085	
50	2.782	45971-5185	45971-5285	45971-5385	45971-5485	45971-5585	45971-5685	45971-5785	45971-5885	45971-5985	45971-6085	
15	1.032	45971-6185	45971-6285	45971-6385	45971-6485	45971-6585	45971-6685	45971-6785	45971-6885	45971-6985	45971-7085	
25	1.532	45971-7185	45971-7285	45971-7385	45971-7485	45971-7585	45971-7685	45971-7785	45971-7885	45971-7985	45971-8085	
35	2.032	45971-8185	45971-8285	45971-8385	45971-8485	45971-8585	45971-8685	45971-8785	45971-8885	45971-8985	45971-9085	
45	2.532	45971-9185	45971-9285	45971-9385	45971-9485	45971-9585	45971-9685	45971-9785	45971-9885	45971-9985	45971-10085	

NOTES:  
1. THIS SHEET CONTAINS THE FOLLOWING OPTIONS  
NO OF ROWS: 8  
SOLDER CHARGE: TIN  
PACKAGING: TRAYS AND TAPE AND REEL

<b>SEE SHEET 1</b> EC NO: UCP2010-2270 DRWN: TGREGORI 2010/03/05 CHKD: JCOMERCI 2005/05/17 APPR: JCOMERCI 2010/03/05	DESCRIPTION REV	GENERAL TOLERANCES (UNLESS SPECIFIED)		DIMENSION STYLE <b>INCH ONLY</b>		SCALE <b>1:1</b>	DESIGN UNITS <b>INCH</b>	THIRD ANGLE PROJECTION		
		4 PLACES	± ---	± ---	DRAWN BY TGREGORI	DATE 2005/05/17	TITLE <b>SEARAY RECEPTACLE ASSEMBLY .050 CENTERS</b>			
		3 PLACES	± ---	± .005	CHECKED BY JCOMERCI	DATE 2005/05/17				
		2 PLACES	± ---	± ---	APPROVED BY JCOMERCI	DATE 2010/03/05				
		1 PLACE	± ---	± ---	MATERIAL NO. <b>SEE CHART</b>					
ANGULAR ± ---°			DRAFT WHERE APPLICABLE MUST REMAIN WITHIN DIMENSIONS		DOCUMENT NO. <b>SD-45971-001</b>		SHEET NO. <b>5 OF 10</b>			
			SIZE <b>A</b>		THIS DRAWING CONTAINS INFORMATION THAT IS PROPRIETARY TO MOLEX INCORPORATED AND SHOULD NOT BE USED WITHOUT WRITTEN PERMISSION					

6		5		4		3	
DIM R: (REF)		5.0 MM		6.0 MM		8.0 MM	
DIM R: HOUSING HEIGHT							
POSITION		MATERIAL NO		MATERIAL NO		MATERIAL NO	
19	1.232	45971-0183	45971-0283	45971-0383	45971-0483	45971-0583	
10	0.782	45971-1183	45971-1283	45971-1383	45971-1483	45971-1583	
20	1.282	45971-2183	45971-2283	45971-2383	45971-2483	45971-2583	
30	1.782	45971-3183	45971-3283	45971-3383	45971-3483	45971-3583	
40	2.282	45971-4183	45971-4283	45971-4383	45971-4483	45971-4583	
50	2.782	45971-5183	45971-5283	45971-5383	45971-5483	45971-5583	
15	1.032	45971-6183	45971-6283	45971-6383	45971-6483	45971-6583	
25	1.532	45971-7183	45971-7283	45971-7383	45971-7483	45971-7583	
35	2.032	45971-8183	45971-8283	45971-8383	45971-8483	45971-8583	
45	2.532	45971-9183	45971-9283	45971-9383	45971-9483	45971-9583	

STACK HEIGHTS GIVEN IN METRIC FOR REF ONLY

6		5		4		3	
DIM R: (REF)		5.0 MM		6.0 MM		8.0 MM	
DIM R: HOUSING HEIGHT							
POSITION		MATERIAL NO		MATERIAL NO		MATERIAL NO	
19	1.232	45971-0187	45971-0287	45971-0387	45971-0487	45971-0587	
10	0.782	45971-1187	45971-1287	45971-1387	45971-1487	45971-1587	
20	1.282	45971-2187	45971-2287	45971-2387	45971-2487	45971-2587	
30	1.782	45971-3187	45971-3287	45971-3387	45971-3487	45971-3587	
40	2.282	45971-4187	45971-4287	45971-4387	45971-4487	45971-4587	
50	2.782	45971-5187	45971-5287	45971-5387	45971-5487	45971-5587	
15	1.032	45971-6187	45971-6287	45971-6387	45971-6487	45971-6587	
25	1.532	45971-7187	45971-7287	45971-7387	45971-7487	45971-7587	
35	2.032	45971-8187	45971-8287	45971-8387	45971-8487	45971-8587	
45	2.532	45971-9187	45971-9287	45971-9387	45971-9487	45971-9587	

STACK HEIGHTS GIVEN IN METRIC FOR REF ONLY

NOTES:  
 1. THIS SHEET CONTAINS THE FOLLOWING OPTIONS  
 NO OF ROWS: 8  
 SOLDER CHARGE: TIN / LEAD  
 PACKAGING: TRAYS AND TAPE AND REEL

SEE SHEET 1  
 EC NO: UCP2010-2270  
 DRWN: TGREGORI 2010/03/05  
 CH'KD: JCOMERCI 2005/05/17  
 APPR: JCOMERCI 2010/03/05

DESCRIPTION	GENERAL TOLERANCES (UNLESS SPECIFIED)		DIMENSION STYLE	
			INCH ONLY	
		mm	INCH	
	4 PLACES	± ---	± ---	
	3 PLACES	± ---	± .005	
2 PLACES	± ---	± ---		
1 PLACE	± ---	± ---		
	ANGULAR ± ---°			
	DRAFT WHERE APPLICABLE MUST REMAIN WITHIN DIMENSIONS			

SCALE 1:1	DESIGN UNITS INCH	THIRD ANGLE PROJECTION
TITLE		
SEARAY RECEPTACLE ASSEMBLY .050 CENTERS		
MOLEX INCORPORATED		
MATERIAL NO.	DOCUMENT NO.	SHEET NO.
SEE CHART	SD-45971-001	6 OF 10
THIS DRAWING CONTAINS INFORMATION THAT IS PROPRIETARY TO MOLEX INCORPORATED AND SHOULD NOT BE USED WITHOUT WRITTEN PERMISSION		



6		5		4		3	
DIM R: (REF)		5.0 MM		6.0 MM		8.0 MM	
DIM R: HOUSING HEIGHT							
POSITION		MATERIAL NO		MATERIAL NO		MATERIAL NO	
19	1.232	45971-0111	45971-0211	45971-0311	45971-0411	45971-0511	
10	0.782	45971-1111	45971-1211	45971-1311	45971-1411	45971-1511	
20	1.282	45971-2111	45971-2211	45971-2311	45971-2411	45971-2511	
30	1.782	45971-3111	45971-3211	45971-3311	45971-3411	45971-3511	
40	2.282	45971-4111	45971-4211	45971-4311	45971-4411	45971-4511	
50	2.782	45971-5111	45971-5211	45971-5311	45971-5411	45971-5511	
15	1.032	45971-6111	45971-6211	45971-6311	45971-6411	45971-6511	
25	1.532	45971-7111	45971-7211	45971-7311	45971-7411	45971-7511	
35	2.032	45971-8111	45971-8211	45971-8311	45971-8411	45971-8511	
45	2.532	45971-9111	45971-9211	45971-9311	45971-9411	45971-9511	

STACK HEIGHTS GIVEN IN METRIC FOR REF ONLY

6		5		4		3	
DIM R: (REF)		5.0 MM		6.0 MM		8.0 MM	
DIM R: HOUSING HEIGHT							
POSITION		MATERIAL NO		MATERIAL NO		MATERIAL NO	
19	1.232	45971-0115	45971-0215	45971-0315	45971-0415	45971-0515	
10	0.782	45971-1115	45971-1215	45971-1315	45971-1415	45971-1515	
20	1.282	45971-2115	45971-2215	45971-2315	45971-2415	45971-2515	
30	1.782	45971-3115	45971-3215	45971-3315	45971-3415	45971-3515	
40	2.282	45971-4115	45971-4215	45971-4315	45971-4415	45971-4515	
50	2.782	45971-5115	45971-5215	45971-5315	45971-5415	45971-5515	
15	1.032	45971-6115	45971-6215	45971-6315	45971-6415	45971-6515	
25	1.532	45971-7115	45971-7215	45971-7315	45971-7415	45971-7515	
35	2.032	45971-8115	45971-8215	45971-8315	45971-8415	45971-8515	
45	2.532	45971-9115	45971-9215	45971-9315	45971-9415	45971-9515	

STACK HEIGHTS GIVEN IN METRIC FOR REF ONLY

SEE SHEET 1 EC NO: UCP2010-2270 DRWN: TGREGORI 2010/03/05 CH'KD: JCOMERC I 2005/05/17 APPR: JCOMERC I 2010/03/05	DESCRIPTION
	REV
	0

GENERAL TOLERANCES (UNLESS SPECIFIED)		
	mm	INCH
4 PLACES	± .005	± .0005
3 PLACES	± .005	± .0005
2 PLACES	± .005	± .0005
1 PLACE	± .005	± .0005
ANGULAR ± .005°		
DRAFT WHERE APPLICABLE MUST REMAIN WITHIN DIMENSIONS		

DIMENSION STYLE	
INCH ONLY	
DRAWN BY	DATE
TGREGORI	2005/05/17
CHECKED BY	DATE
JCOMERC I	2005/05/17
APPROVED BY	DATE
JCOMERC I	2010/03/05
MATERIAL NO.	
SEE CHART	

SCALE	DESIGN UNITS	THIRD ANGLE PROJECTION
1:1	INCH	
TITLE		
SEARAY RECEPTACLE ASSEMBLY .050 CENTERS		
MOLEX INCORPORATED		
DOCUMENT NO.		SHEET NO.
SD-45971-001		7 OF 10

NOTES:  
 1. THIS SHEET CONTAINS THE FOLLOWING OPTIONS  
 NO OF ROWS: 10  
 SOLDER CHARGE: TIN  
 PACKAGING: TRAYS AND TAPE AND REEL

6		5		4		3		2		1		
DIM R: (REF)		5.0 MM		6.0 MM		6.5 MM		7.5 MM		8.0 MM		STACK HEIGHTS GIVEN IN METRIC FOR REF ONLY
DIM R: HOUSING HEIGHT												
		.199		.238		.258		.297		.297		
POSITION	DIM M	MATERIAL NO	MATERIAL NO	MATERIAL NO	MATERIAL NO	MATERIAL NO	MATERIAL NO	MATERIAL NO	MATERIAL NO	MATERIAL NO	MATERIAL NO	
19	1.232	45971-0113	45971-0213	45971-0313	45971-0413	45971-0513	45971-0613	45971-0713	45971-0813	45971-0913	45971-1013	
10	0.782	45971-1113	45971-1213	45971-1313	45971-1413	45971-1513	45971-1613	45971-1713	45971-1813	45971-1913	45971-2013	
20	1.282	45971-2113	45971-2213	45971-2313	45971-2413	45971-2513	45971-2613	45971-2713	45971-2813	45971-2913	45971-3013	
30	1.782	45971-3113	45971-3213	45971-3313	45971-3413	45971-3513	45971-3613	45971-3713	45971-3813	45971-3913	45971-4013	
40	2.282	45971-4113	45971-4213	45971-4313	45971-4413	45971-4513	45971-4613	45971-4713	45971-4813	45971-4913	45971-5013	
50	2.782	45971-5113	45971-5213	45971-5313	45971-5413	45971-5513	45971-5613	45971-5713	45971-5813	45971-5913	45971-6013	
15	1.032	45971-6113	45971-6213	45971-6313	45971-6413	45971-6513	45971-6613	45971-6713	45971-6813	45971-6913	45971-7013	
25	1.532	45971-7113	45971-7213	45971-7313	45971-7413	45971-7513	45971-7613	45971-7713	45971-7813	45971-7913	45971-8013	
35	2.032	45971-8113	45971-8213	45971-8313	45971-8413	45971-8513	45971-8613	45971-8713	45971-8813	45971-8913	45971-9013	
45	2.532	45971-9113	45971-9213	45971-9313	45971-9413	45971-9513	45971-9613	45971-9713	45971-9813	45971-9913	45971-10013	

6		5		4		3		2		1		
DIM R: (REF)		5.0 MM		6.0 MM		6.5 MM		7.5 MM		8.0 MM		STACK HEIGHTS GIVEN IN METRIC FOR REF ONLY
DIM R: HOUSING HEIGHT												
		.199		.238		.258		.297		.297		
POSITION	DIM M	MATERIAL NO	MATERIAL NO	MATERIAL NO	MATERIAL NO	MATERIAL NO	MATERIAL NO	MATERIAL NO	MATERIAL NO	MATERIAL NO	MATERIAL NO	
19	1.232	45971-0117	45971-0217	45971-0317	45971-0417	45971-0517	45971-0617	45971-0717	45971-0817	45971-0917	45971-1017	
10	0.782	45971-1117	45971-1217	45971-1317	45971-1417	45971-1517	45971-1617	45971-1717	45971-1817	45971-1917	45971-2017	
20	1.282	45971-2117	45971-2217	45971-2317	45971-2417	45971-2517	45971-2617	45971-2717	45971-2817	45971-2917	45971-3017	
30	1.782	45971-3117	45971-3217	45971-3317	45971-3417	45971-3517	45971-3617	45971-3717	45971-3817	45971-3917	45971-4017	
40	2.282	45971-4117	45971-4217	45971-4317	45971-4417	45971-4517	45971-4617	45971-4717	45971-4817	45971-4917	45971-5017	
50	2.782	45971-5117	45971-5217	45971-5317	45971-5417	45971-5517	45971-5617	45971-5717	45971-5817	45971-5917	45971-6017	
15	1.032	45971-6117	45971-6217	45971-6317	45971-6417	45971-6517	45971-6617	45971-6717	45971-6817	45971-6917	45971-7017	
25	1.532	45971-7117	45971-7217	45971-7317	45971-7417	45971-7517	45971-7617	45971-7717	45971-7817	45971-7917	45971-8017	
35	2.032	45971-8117	45971-8217	45971-8317	45971-8417	45971-8517	45971-8617	45971-8717	45971-8817	45971-8917	45971-9017	
45	2.532	45971-9117	45971-9217	45971-9317	45971-9417	45971-9517	45971-9617	45971-9717	45971-9817	45971-9917	45971-10017	

NOTES:  
 1. THIS SHEET CONTAINS THE FOLLOWING OPTIONS  
 NO OF ROWS: 10  
 SOLDER CHARGE: TIN / LEAD  
 PACKAGING: TRAYS AND TAPE AND REEL

SEE SHEET 1 EC NO: UCP2010-2270 DRWN: TGREGORI 2010/03/05 CH'KD: JCOMERCI 2005/05/17 APPR: JCOMERCI 2010/03/05	DESCRIPTION REV	GENERAL TOLERANCES (UNLESS SPECIFIED)		DIMENSION STYLE INCH ONLY		SCALE 1:1	DESIGN UNITS INCH	THIRD ANGLE PROJECTION		
			mm	INCH	DRAWN BY	DATE	TITLE <b>SEARAY          RECEPTACLE ASSEMBLY          .050 CENTERS</b>  <b>MOLEX INCORPORATED</b>  DOCUMENT NO. SD-45971-001 SHEET NO. 8 OF 10			
		4 PLACES	± .005	± .005	TGREGORI	2005/05/17				
		3 PLACES	± .005	± .005	JCOMERCI	2005/05/17				
		2 PLACES	± .005	± .005	JCOMERCI	2005/05/17				
1 PLACE	± .005	± .005	JCOMERCI	2010/03/05						
		ANGULAR ± .005°		APPROVED BY						
				MATERIAL NO.						
		DRAFT WHERE APPLICABLE MUST REMAIN WITHIN DIMENSIONS		SEE CHART						
				SIZE A	THIS DRAWING CONTAINS INFORMATION THAT IS PROPRIETARY TO MOLEX INCORPORATED AND SHOULD NOT BE USED WITHOUT WRITTEN PERMISSION					

6		5		4		3		2		1	
DIM R: (REF)		5.0 MM		6.0 MM		6.5 MM		7.5 MM		8.0 MM	
DIM R: HOUSING HEIGHT											
		.199		.238		.258		.297		.297	
POSITION	DIM M	MATERIAL NO	MATERIAL NO	MATERIAL NO	MATERIAL NO	MATERIAL NO	MATERIAL NO	MATERIAL NO	MATERIAL NO	MATERIAL NO	MATERIAL NO
19	1.232	45971-0121	45971-0221	45971-0321	45971-0421	45971-0521	45971-0621	45971-0721	45971-0821	45971-0921	45971-1021
10	0.782	45971-1121	45971-1221	45971-1321	45971-1421	45971-1521	45971-1621	45971-1721	45971-1821	45971-1921	45971-2021
20	1.282	45971-2121	45971-2221	45971-2321	45971-2421	45971-2521	45971-2621	45971-2721	45971-2821	45971-2921	45971-3021
30	1.782	45971-3121	45971-3221	45971-3321	45971-3421	45971-3521	45971-3621	45971-3721	45971-3821	45971-3921	45971-4021
40	2.282	45971-4121	45971-4221	45971-4321	45971-4421	45971-4521	45971-4621	45971-4721	45971-4821	45971-4921	45971-5021
50	2.782	45971-5121	45971-5221	45971-5321	45971-5421	45971-5521	45971-5621	45971-5721	45971-5821	45971-5921	45971-6021
15	1.032	45971-6121	45971-6221	45971-6321	45971-6421	45971-6521	45971-6621	45971-6721	45971-6821	45971-6921	45971-7021
25	1.532	45971-7121	45971-7221	45971-7321	45971-7421	45971-7521	45971-7621	45971-7721	45971-7821	45971-7921	45971-8021
35	2.032	45971-8121	45971-8221	45971-8321	45971-8421	45971-8521	45971-8621	45971-8721	45971-8821	45971-8921	45971-9021
45	2.532	45971-9121	45971-9221	45971-9321	45971-9421	45971-9521	45971-9621	45971-9721	45971-9821	45971-9921	45971-10021

STACK HEIGHTS GIVEN IN METRIC FOR REF ONLY

6		5		4		3		2		1	
DIM R: (REF)		5.0 MM		6.0 MM		6.5 MM		7.5 MM		8.0 MM	
DIM R: HOUSING HEIGHT											
		.199		.238		.258		.297		.297	
POSITION	DIM M	MATERIAL NO	MATERIAL NO	MATERIAL NO	MATERIAL NO	MATERIAL NO	MATERIAL NO	MATERIAL NO	MATERIAL NO	MATERIAL NO	MATERIAL NO
19	1.232	45971-0125	45971-0225	45971-0325	45971-0425	45971-0525	45971-0625	45971-0725	45971-0825	45971-0925	45971-1025
10	0.782	45971-1125	45971-1225	45971-1325	45971-1425	45971-1525	45971-1625	45971-1725	45971-1825	45971-1925	45971-2025
20	1.282	45971-2125	45971-2225	45971-2325	45971-2425	45971-2525	45971-2625	45971-2725	45971-2825	45971-2925	45971-3025
30	1.782	45971-3125	45971-3225	45971-3325	45971-3425	45971-3525	45971-3625	45971-3725	45971-3825	45971-3925	45971-4025
40	2.282	45971-4125	45971-4225	45971-4325	45971-4425	45971-4525	45971-4625	45971-4725	45971-4825	45971-4925	45971-5025
50	2.782	45971-5125	45971-5225	45971-5325	45971-5425	45971-5525	45971-5625	45971-5725	45971-5825	45971-5925	45971-6025
15	1.032	45971-6125	45971-6225	45971-6325	45971-6425	45971-6525	45971-6625	45971-6725	45971-6825	45971-6925	45971-7025
25	1.532	45971-7125	45971-7225	45971-7325	45971-7425	45971-7525	45971-7625	45971-7725	45971-7825	45971-7925	45971-8025
35	2.032	45971-8125	45971-8225	45971-8325	45971-8425	45971-8525	45971-8625	45971-8725	45971-8825	45971-8925	45971-9025
45	2.532	45971-9125	45971-9225	45971-9325	45971-9425	45971-9525	45971-9625	45971-9725	45971-9825	45971-9925	45971-10025

STACK HEIGHTS GIVEN IN METRIC FOR REF ONLY

NOTES:  
 1. THIS SHEET CONTAINS THE FOLLOWING OPTIONS  
 NO OF ROWS: 12  
 SOLDER CHARGE: TIN  
 PACKAGING: TRAYS AND TAPE AND REEL

SEE SHEET 1 EC NO: UCP2010-2270 DRWN: TGREGORI 2010/03/05 CH'KD: JCOMERC I 2005/05/17 APPR: JCOMERC I 2010/03/05	DESCRIPTION	GENERAL TOLERANCES (UNLESS SPECIFIED)		DIMENSION STYLE <b>INCH ONLY</b>		SCALE <b>3:1</b>	DESIGN UNITS <b>INCH</b>	THIRD ANGLE PROJECTION		
			mm	INCH	DRAWN BY TGREGORI	DATE 2005/05/17	TITLE <b>SEARAY RECEPTACLE ASSEMBLY .050 CENTERS</b>  <b>MOLEX INCORPORATED</b>			
		4 PLACES	± ---	± ---	CHECKED BY JCOMERC I	DATE 2005/05/17				
		3 PLACES	± ---	± .005	APPROVED BY JCOMERC I	DATE 2010/03/05				
		2 PLACES	± ---	± ---	MATERIAL NO.	DOCUMENT NO.				
1 PLACE	± ---	± ---	ANGULAR ± ---°		SEE CHART		SD-45971-001		SHEET NO. 9 OF 10	
DRAFT WHERE APPLICABLE MUST REMAIN WITHIN DIMENSIONS			SIZE <b>A</b>		THIS DRAWING CONTAINS INFORMATION THAT IS PROPRIETARY TO MOLEX INCORPORATED AND SHOULD NOT BE USED WITHOUT WRITTEN PERMISSION					

6		5		4		3		2		1		
DIM R: (REF)		5.0 MM		6.0 MM		6.5 MM		7.5 MM		8.0 MM		STACK HEIGHTS GIVEN IN METRIC FOR REF ONLY
DIM R: HOUSING HEIGHT												
		.199		.238		.258		.297		.297		
POSITION	DIM M	MATERIAL NO	MATERIAL NO	MATERIAL NO	MATERIAL NO	MATERIAL NO	MATERIAL NO	MATERIAL NO	MATERIAL NO	MATERIAL NO		
19	1.232	45971-0123	45971-0223	45971-0323	45971-0423	45971-0523	45971-0623	45971-0723	45971-0823	45971-0923		
10	0.782	45971-1123	45971-1223	45971-1323	45971-1423	45971-1523	45971-1623	45971-1723	45971-1823	45971-1923		
20	1.282	45971-2123	45971-2223	45971-2323	45971-2423	45971-2523	45971-2623	45971-2723	45971-2823	45971-2923		
30	1.782	45971-3123	45971-3223	45971-3323	45971-3423	45971-3523	45971-3623	45971-3723	45971-3823	45971-3923		
40	2.282	45971-4123	45971-4223	45971-4323	45971-4423	45971-4523	45971-4623	45971-4723	45971-4823	45971-4923		
50	2.782	45971-5123	45971-5223	45971-5323	45971-5423	45971-5523	45971-5623	45971-5723	45971-5823	45971-5923		
15	1.032	45971-6123	45971-6223	45971-6323	45971-6423	45971-6523	45971-6623	45971-6723	45971-6823	45971-6923		
25	1.532	45971-7123	45971-7223	45971-7323	45971-7423	45971-7523	45971-7623	45971-7723	45971-7823	45971-7923		
35	2.032	45971-8123	45971-8223	45971-8323	45971-8423	45971-8523	45971-8623	45971-8723	45971-8823	45971-8923		
45	2.532	45971-9123	45971-9223	45971-9323	45971-9423	45971-9523	45971-9623	45971-9723	45971-9823	45971-9923		

6		5		4		3		2		1		
DIM R: (REF)		5.0 MM		6.0 MM		6.5 MM		7.5 MM		8.0 MM		STACK HEIGHTS GIVEN IN METRIC FOR REF ONLY
DIM R: HOUSING HEIGHT												
		.199		.238		.258		.297		.297		
POSITION	DIM M	MATERIAL NO	MATERIAL NO	MATERIAL NO	MATERIAL NO	MATERIAL NO	MATERIAL NO	MATERIAL NO	MATERIAL NO	MATERIAL NO		
19	1.232	45971-0127	45971-0227	45971-0327	45971-0427	45971-0527	45971-0627	45971-0727	45971-0827	45971-0927		
10	0.782	45971-1127	45971-1227	45971-1327	45971-1427	45971-1527	45971-1627	45971-1727	45971-1827	45971-1927		
20	1.282	45971-2127	45971-2227	45971-2327	45971-2427	45971-2527	45971-2627	45971-2727	45971-2827	45971-2927		
30	1.782	45971-3127	45971-3227	45971-3327	45971-3427	45971-3527	45971-3627	45971-3727	45971-3827	45971-3927		
40	2.282	45971-4127	45971-4227	45971-4327	45971-4427	45971-4527	45971-4627	45971-4727	45971-4827	45971-4927		
50	2.782	45971-5127	45971-5227	45971-5327	45971-5427	45971-5527	45971-5627	45971-5727	45971-5827	45971-5927		
15	1.032	45971-6127	45971-6227	45971-6327	45971-6427	45971-6527	45971-6627	45971-6727	45971-6827	45971-6927		
25	1.532	45971-7127	45971-7227	45971-7327	45971-7427	45971-7527	45971-7627	45971-7727	45971-7827	45971-7927		
35	2.032	45971-8127	45971-8227	45971-8327	45971-8427	45971-8527	45971-8627	45971-8727	45971-8827	45971-8927		
45	2.532	45971-9127	45971-9227	45971-9327	45971-9427	45971-9527	45971-9627	45971-9727	45971-9827	45971-9927		

NOTES:  
 1. THIS SHEET CONTAINS THE FOLLOWING OPTIONS  
 NO OF ROWS: 12  
 SOLDER CHARGE: TIN / LEAD  
 PACKAGING: TRAYS AND TAPE AND REEL

SEE SHEET 1 EC NO: UCP2010-2270 DRWN: TGREGORI 2010/03/05 CHKD: JCOMERC I 2005/05/17 APPR: JCOMERC I 2010/03/05 DESCRIPTION REV	GENERAL TOLERANCES (UNLESS SPECIFIED)		DIMENSION STYLE <b>INCH ONLY</b>		SCALE <b>1:1</b>	DESIGN UNITS <b>INCH</b>	THIRD ANGLE PROJECTION		
	4 PLACES ± --- ± ---		DRAWN BY DATE TGREGORI 2005/05/17		TITLE <b>SEARAY RECEPTACLE ASSEMBLY .050 CENTERS</b>				
	3 PLACES ± --- ± .005		CHECKED BY DATE JCOMERC I 2005/05/17						
	2 PLACES ± --- ± ---		APPROVED BY DATE JCOMERC I 2010/03/05		 <b>MOLEX INCORPORATED</b> DOCUMENT NO. <b>SD-45971-001</b> SHEET NO. <b>10 OF 10</b>				
	1 PLACE ± --- ± ---		MATERIAL NO.						
ANGULAR ± ---°		DRAFT WHERE APPLICABLE MUST REMAIN WITHIN DIMENSIONS		<b>SEE CHART</b>		THIS DRAWING CONTAINS INFORMATION THAT IS PROPRIETARY TO MOLEX INCORPORATED AND SHOULD NOT BE USED WITHOUT WRITTEN PERMISSION			



Компания «ЭлектроПласт» предлагает заключение долгосрочных отношений при поставках импортных электронных компонентов на взаимовыгодных условиях!

Наши преимущества:

- Оперативные поставки широкого спектра электронных компонентов отечественного и импортного производства напрямую от производителей и с крупнейших мировых складов;
- Поставка более 17-ти миллионов наименований электронных компонентов;
- Поставка сложных, дефицитных, либо снятых с производства позиций;
- Оперативные сроки поставки под заказ (от 5 рабочих дней);
- Экспресс доставка в любую точку России;
- Техническая поддержка проекта, помощь в подборе аналогов, поставка прототипов;
- Система менеджмента качества сертифицирована по Международному стандарту ISO 9001;
- Лицензия ФСБ на осуществление работ с использованием сведений, составляющих государственную тайну;
- Поставка специализированных компонентов (Xilinx, Altera, Analog Devices, Intersil, Interpoint, Microsemi, Aeroflex, Peregrine, Syfer, Eurofarad, Texas Instrument, Miteq, Cobham, E2V, MA-COM, Hittite, Mini-Circuits, General Dynamics и др.);

Помимо этого, одним из направлений компании «ЭлектроПласт» является направление «Источники питания». Мы предлагаем Вам помощь Конструкторского отдела:

- Подбор оптимального решения, техническое обоснование при выборе компонента;
- Подбор аналогов;
- Консультации по применению компонента;
- Поставка образцов и прототипов;
- Техническая поддержка проекта;
- Защита от снятия компонента с производства.



#### Как с нами связаться

**Телефон:** 8 (812) 309 58 32 (многоканальный)

**Факс:** 8 (812) 320-02-42

**Электронная почта:** [org@eplast1.ru](mailto:org@eplast1.ru)

**Адрес:** 198099, г. Санкт-Петербург, ул. Калинина, дом 2, корпус 4, литера А.