

## ADD-A-PAK Generation VII Power Modules Schottky Rectifier, 220 A

**ADD-A-PAK**

PRODUCT SUMMARY	
$I_{F(AV)}$	220 A
$V_R$	30 V
Package	ADD-A-PAK
Circuit	Two diodes common cathodes

### MECHANICAL DESCRIPTION

The ADD-A-PAK generation VII, new generation of ADD-A-PAK module, combines the excellent thermal performances obtained by the usage of exposed direct bonded copper substrate, with advanced compact simple package solution and simplified internal structure with minimized number of interfaces.

### FEATURES

- 150 °C  $T_J$  operation
- Low forward voltage drop
- High frequency operation
- Low thermal resistance
- UL approved file E78996
- Designed and qualified for industrial level
- Material categorization: For definitions of compliance please see [www.vishay.com/doc?99912](http://www.vishay.com/doc?99912)

**RoHS  
COMPLIANT**

### BENEFITS

- Excellent thermal performances obtained by the usage of exposed direct bonded copper substrate
- High surge capability
- Easy mounting on heatsink

### ELECTRICAL DESCRIPTION

The VS-VSKCS220/030 Schottky rectifier common cathode has been optimized for low reverse leakage at high temperature. The proprietary barrier technology allows for reliable operation up to 150 °C junction temperature. Typical applications are in high current switching power supplies, plating power supplies, UPS systems, converters, freewheeling diodes, welding, and reverse battery protection.

MAJOR RATINGS AND CHARACTERISTICS			
SYMBOL	CHARACTERISTICS	VALUES	UNITS
$I_{F(AV)}$	Rectangular waveform	220	A
$V_{RRM}$		30	V
$I_{FSM}$	$t_p = 5 \mu s$ sine	18 000	A
$V_F$	110 A <sub>pk</sub> , $T_J = 125 \text{ }^\circ\text{C}$	0.57	V
$T_J$	Range	-55 to 150	°C

VOLTAGE RATINGS			
PARAMETER	SYMBOL	VS-VSKCS220/030	UNITS
Maximum DC reverse voltage	$V_R$	30	V
Maximum working peak reverse voltage	$V_{RWM}$		



ABSOLUTE MAXIMUM RATINGS					
PARAMETER	SYMBOL	TEST CONDITIONS		VALUES	UNITS
Maximum average forward current	$I_{F(AV)}$	50 % duty cycle at $T_C = 110\text{ }^\circ\text{C}$ , rectangular waveform		220	A
				per module	
Maximum peak one cycle non-repetitive surge current	$I_{FSM}$	5 $\mu\text{s}$ sine or 3 $\mu\text{s}$ rect. pulse	Following any rated load condition and with rated $V_{RRM}$ applied	18 000	
		10 ms sine or 6 ms rect. pulse		2000	
Non-repetitive avalanche energy	$E_{AS}$	$T_J = 25\text{ }^\circ\text{C}$ , $I_{AS} = 15\text{ A}$ , $L = 1\text{ mH}$		99	mJ
Repetitive avalanche current	$I_{AR}$	Current decaying linearly to zero in 1 $\mu\text{s}$ Frequency limited by $T_J$ maximum $V_A = 1.5 \times V_R$ typical		22	A

ELECTRICAL SPECIFICATIONS					
PARAMETER	SYMBOL	TEST CONDITIONS		VALUES	UNITS
Maximum forward voltage drop	$V_{FM}$	110 A	$T_J = 25\text{ }^\circ\text{C}$	0.59	V
		220 A		0.78	
		110 A	$T_J = 125\text{ }^\circ\text{C}$	0.57	
		220 A		0.82	
Maximum reverse leakage current	$I_{RM}$	$T_J = 25\text{ }^\circ\text{C}$	$V_R = \text{Rated } V_R$	10	mA
		$T_J = 125\text{ }^\circ\text{C}$		650	
Maximum junction capacitance	$C_T$	$V_R = 5\text{ V}_{DC}$ (test signal range 100 kHz to 1 MHz), $25\text{ }^\circ\text{C}$		7400	pF
Typical series inductance	$L_S$	Measured lead to lead 5 mm from package body		7.0	nH
Maximum voltage rate of change	$dV/dt$	Rated $V_R$		10 000	V/ $\mu\text{s}$
Maximum RMS insulation voltage	$V_{INS}$	50 Hz		3000 (1 min)	V
				3600 (1 s)	

THERMAL - MECHANICAL SPECIFICATIONS					
PARAMETER	SYMBOL	TEST CONDITIONS		VALUES	UNITS
Maximum junction and storage temperature range	$T_J, T_{Stg}$			-55 to 150	$^\circ\text{C}$
Maximum thermal resistance, junction to case per leg	$R_{thJC}$	DC operation		0.52	$^\circ\text{C/W}$
Typical thermal resistance, case to heatsink per module	$R_{thCS}$			0.1	
Approximate weight				75	g
				2.7	oz.
Mounting torque $\pm 10\%$	to heatsink	A mounting compound is recommended and the torque should be rechecked after a period of 3 h to allow for the spread of the compound.		4	Nm
	busbar			3	
Case style		JEDEC®		TO-240AA compatible	

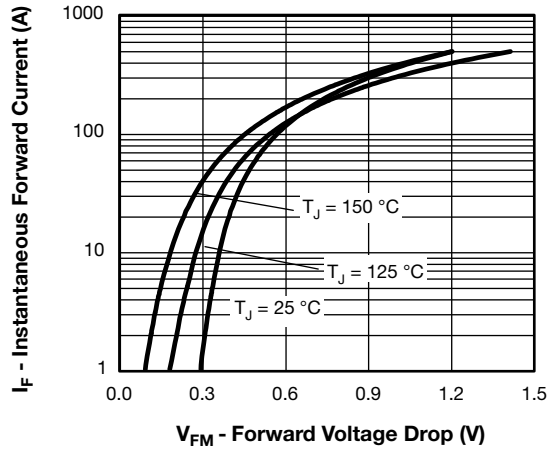

Fig. 1 - Maximum Forward Voltage Drop Characteristics

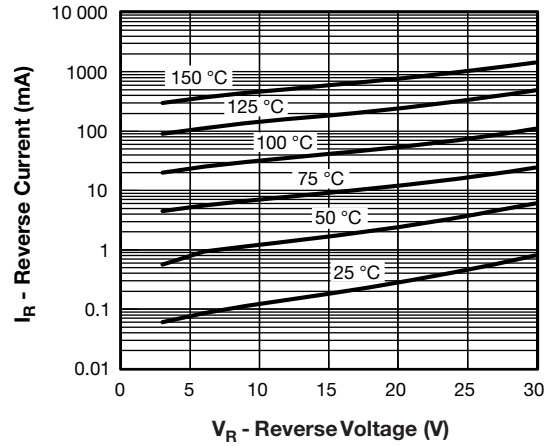

Fig. 2 - Typical Values of Reverse Current vs. Reverse Voltage

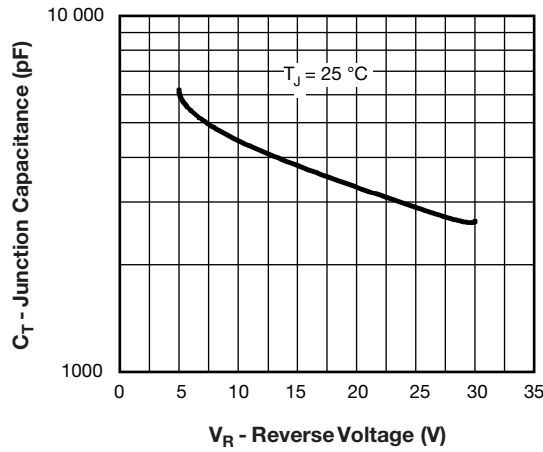

Fig. 3 - Typical Junction Capacitance vs. Reverse Voltage

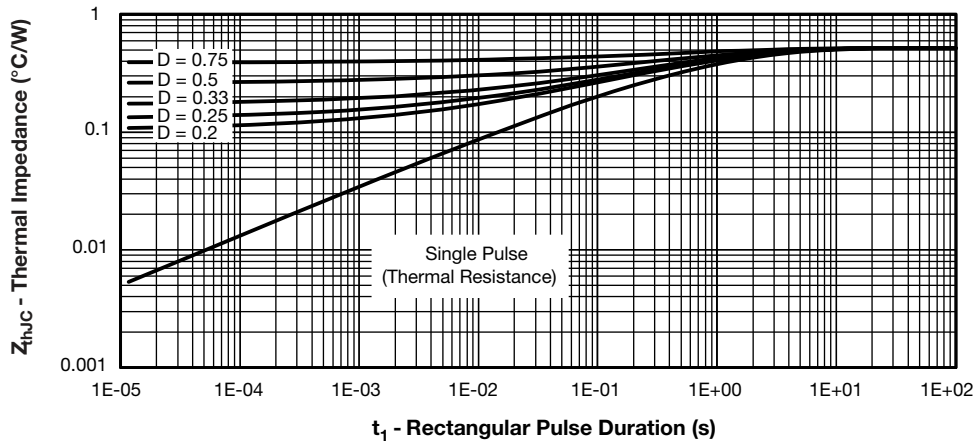

Fig. 4 - Maximum Thermal Impedance  $Z_{thJC}$  Characteristics

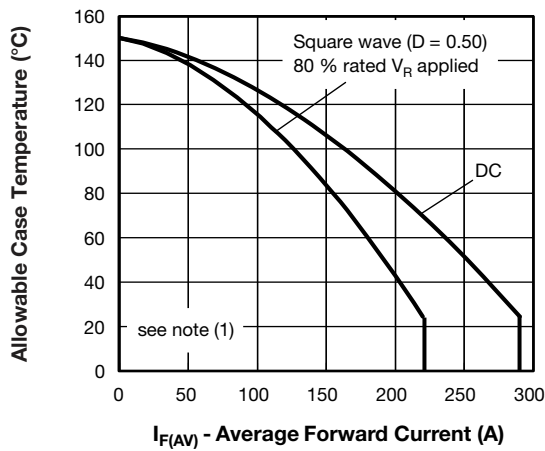

Fig. 5 - Maximum Allowable Case Temperature vs. Average Forward Current

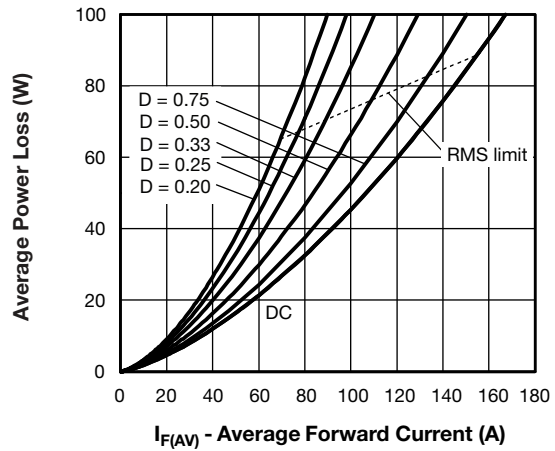

Fig. 6 - Forward Power Loss Characteristics

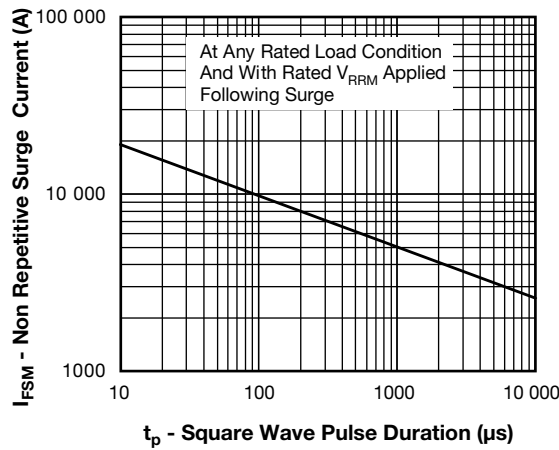

Fig. 7 - Maximum Non-Repetitive Surge Current

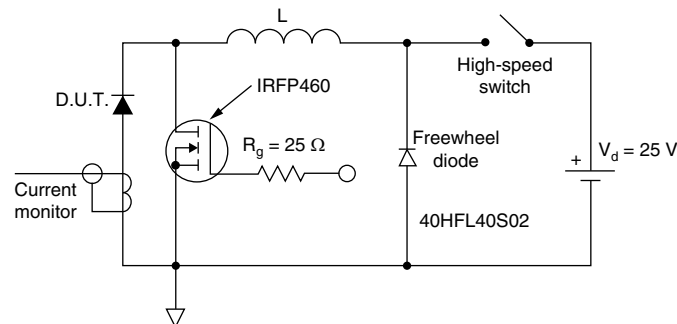

Fig. 8 - Unclamped Inductive Test Circuit

**Note**

- (1) Formula used:  $T_C = T_J - (P_d + P_{d_{REV}}) \times R_{thJC}$ ;  
 $P_d$  = Forward power loss =  $I_{F(AV)} \times V_{FM}$  at  $(I_{F(AV)}/D)$  (see fig. 6);  
 $P_{d_{REV}}$  = Inverse power loss =  $V_{R1} \times I_R (1 - D)$ ;  $I_R$  at  $V_{R1} = 80\%$  rated  $V_R$

**ORDERING INFORMATION TABLE**

Device code	<b>VS-VS</b>	<b>KC</b>	<b>S</b>	<b>22</b>	<b>0</b>	<b>/</b>	<b>030</b>
	①	②	③	④	⑤		⑥

- 1** - VS-VS = Vishay Semiconductors product
- 2** - Circuit configuration:  
KC = ADD-A-PAK - 2 diodes/common cathode
- 3** - S = Schottky diode
- 4** - Average rating (x 10)
- 5** - Product silicon identification
- 6** - Voltage rating (030 = 30 V)

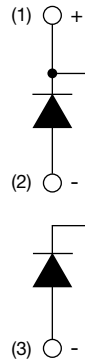
**CIRCUIT CONFIGURATION**

**LINKS TO RELATED DOCUMENTS**

Dimensions	<a href="http://www.vishay.com/doc?95369">www.vishay.com/doc?95369</a>
------------	--

## ADD-A-PAK Generation VII - Diode

**DIMENSIONS** in millimeters (inches)





## Disclaimer

ALL PRODUCT, PRODUCT SPECIFICATIONS AND DATA ARE SUBJECT TO CHANGE WITHOUT NOTICE TO IMPROVE RELIABILITY, FUNCTION OR DESIGN OR OTHERWISE.

Vishay Intertechnology, Inc., its affiliates, agents, and employees, and all persons acting on its or their behalf (collectively, "Vishay"), disclaim any and all liability for any errors, inaccuracies or incompleteness contained in any datasheet or in any other disclosure relating to any product.

Vishay makes no warranty, representation or guarantee regarding the suitability of the products for any particular purpose or the continuing production of any product. To the maximum extent permitted by applicable law, Vishay disclaims (i) any and all liability arising out of the application or use of any product, (ii) any and all liability, including without limitation special, consequential or incidental damages, and (iii) any and all implied warranties, including warranties of fitness for particular purpose, non-infringement and merchantability.

Statements regarding the suitability of products for certain types of applications are based on Vishay's knowledge of typical requirements that are often placed on Vishay products in generic applications. Such statements are not binding statements about the suitability of products for a particular application. It is the customer's responsibility to validate that a particular product with the properties described in the product specification is suitable for use in a particular application. Parameters provided in datasheets and/or specifications may vary in different applications and performance may vary over time. All operating parameters, including typical parameters, must be validated for each customer application by the customer's technical experts. Product specifications do not expand or otherwise modify Vishay's terms and conditions of purchase, including but not limited to the warranty expressed therein.

Except as expressly indicated in writing, Vishay products are not designed for use in medical, life-saving, or life-sustaining applications or for any other application in which the failure of the Vishay product could result in personal injury or death. Customers using or selling Vishay products not expressly indicated for use in such applications do so at their own risk. Please contact authorized Vishay personnel to obtain written terms and conditions regarding products designed for such applications.

No license, express or implied, by estoppel or otherwise, to any intellectual property rights is granted by this document or by any conduct of Vishay. Product names and markings noted herein may be trademarks of their respective owners.

## Material Category Policy

**Vishay Intertechnology, Inc. hereby certifies that all its products that are identified as RoHS-Compliant fulfill the definitions and restrictions defined under Directive 2011/65/EU of The European Parliament and of the Council of June 8, 2011 on the restriction of the use of certain hazardous substances in electrical and electronic equipment (EEE) - recast, unless otherwise specified as non-compliant.**

**Please note that some Vishay documentation may still make reference to RoHS Directive 2002/95/EC. We confirm that all the products identified as being compliant to Directive 2002/95/EC conform to Directive 2011/65/EU.**

**Vishay Intertechnology, Inc. hereby certifies that all its products that are identified as Halogen-Free follow Halogen-Free requirements as per JEDEC JS709A standards. Please note that some Vishay documentation may still make reference to the IEC 61249-2-21 definition. We confirm that all the products identified as being compliant to IEC 61249-2-21 conform to JEDEC JS709A standards.**



Компания «ЭлектроПласт» предлагает заключение долгосрочных отношений при поставках импортных электронных компонентов на взаимовыгодных условиях!

Наши преимущества:

- Оперативные поставки широкого спектра электронных компонентов отечественного и импортного производства напрямую от производителей и с крупнейших мировых складов;
- Поставка более 17-ти миллионов наименований электронных компонентов;
- Поставка сложных, дефицитных, либо снятых с производства позиций;
- Оперативные сроки поставки под заказ (от 5 рабочих дней);
- Экспресс доставка в любую точку России;
- Техническая поддержка проекта, помощь в подборе аналогов, поставка прототипов;
- Система менеджмента качества сертифицирована по Международному стандарту ISO 9001;
- Лицензия ФСБ на осуществление работ с использованием сведений, составляющих государственную тайну;
- Поставка специализированных компонентов (Xilinx, Altera, Analog Devices, Intersil, Interpoint, Microsemi, Aeroflex, Peregrine, Syfer, Eurofarad, Texas Instrument, Miteq, Cobham, E2V, MA-COM, Hittite, Mini-Circuits, General Dynamics и др.);

Помимо этого, одним из направлений компании «ЭлектроПласт» является направление «Источники питания». Мы предлагаем Вам помощь Конструкторского отдела:

- Подбор оптимального решения, техническое обоснование при выборе компонента;
- Подбор аналогов;
- Консультации по применению компонента;
- Поставка образцов и прототипов;
- Техническая поддержка проекта;
- Защита от снятия компонента с производства.



#### Как с нами связаться

**Телефон:** 8 (812) 309 58 32 (многоканальный)

**Факс:** 8 (812) 320-02-42

**Электронная почта:** [org@eplast1.ru](mailto:org@eplast1.ru)

**Адрес:** 198099, г. Санкт-Петербург, ул. Калинина, дом 2, корпус 4, литера А.