

ISL8130EV1Z

Evaluation Board

AN1760
Rev 2.00
Aug 7, 2012

Introduction

ISL8130EV1Z is a standard boost converter, which features the universal PWM controller, ISL8130. The evaluation board delivers 32V output at 1.25A. All the necessary components are within the 1.425" x 1.15" PCB area.

The ISL8130 is a universal PWM controller. It is designed to drive N-Channel MOSFETs in a synchronous rectified buck topology for up to 25A instant MOSFET current and can be configured for boost, buck/boost and sepic converters as well. The ISL8130 integrates control, output adjustment, monitoring and protection functions into a single package. The ISL8130 provides simple, voltage mode control with fast transient response.

ISL8130 Key Features

- Operates From:
 - - 4.5V to 5.5V Input for 5V Input
 - - 5.5V to 16V Input
- Resistor-Selectable Switching Frequency from 100kHz to 1.4MHz
- Voltage Margining and External Reference Tracking Modes
- Kelvin Current Sensing
 - Upper MOSFET $r_{DS(ON)}$ for Current Sensing for Buck and Buck/Boost Converter
 - Precision Resistor for Boost and Sepic Converter
- Extensive Protection Functions:
 - Overvoltage, Overcurrent, Undervoltage
- Power-Good Indicator

Evaluation Board Specifications

TABLE 1. EVALUATION BOARD ELECTRICAL SPECIFICATIONS

SPEC	DESCRIPTION	MIN	TYP	MAX	UNIT
VIN	Board Input Range	6	12	16	V
IOC	Input Current	8			A
VOUT		30.5	32	33.5	V
IOUT	VIN = 6V	1.25			A
IOUT	VIN = 12V	2.5			A
η	VIN = 6V, IOUT = 1.25A		90		%
η	VIN = 12V, IOUT = 2.5A		93.5		%



FIGURE 1. ISL8130EV1Z TOP VIEW

TABLE 2. RECOMMENDED COMPONENT SELECTION FOR QUICK EVALUATION

VOUT (V)	R22 (k Ω)	VIN (MIN) (V)	IOUT (A)	Fsw(KHz)/R _T (K Ω)	MOSFET	FORWARD DIODE	INDUCTOR (L, ISAT)
32	174	6	1.25	330kHz/43.2k Ω	BSC100N06LS G	SS5P6	10 μ H, 10A
24	130	9	2	500kHz/28.7k Ω	BSC059N04 LS	SS3P4L	10 μ H, 7A
12	63.4	4.5	3	500kHz/28.7k Ω	BSC057N03 LS	SS5P3	2.2 μ H, 15A

NOTES:

1. Please select the output capacitor with a voltage rating higher than the output.
2. Please contact [Intersil Sales](#) for assistance.

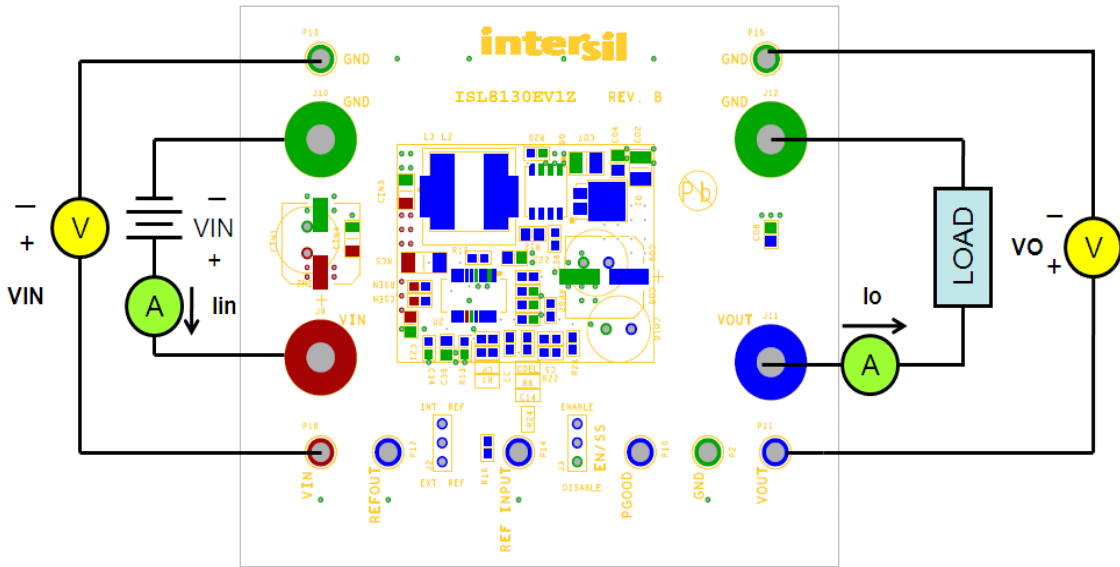

FIGURE 2. ISL8130EV1Z TEST SET-UP

Recommended Equipment

The following equipment is recommended for evaluation:

- 0V to 20V power supply with 15A source current capability
- Electronic load capable of sinking 2A @ 40V
- Digital Multi meters (DMMs)
- 100MHz Quad-Trace Oscilloscope

Quick Test Setup

1. Ensure that the Evaluation board is correctly connected to the power supply and the electronic load prior to applying any power. Please refer to Figure 2 for proper set-up.
2. Leave JP3 in the open position
3. Turn on the power supply; $V_{IN} < 16V$
4. Adjust input voltage V_{IN} within the specified range and observe output voltage. The output voltage variation should be within 5%.
5. Adjust load current within 1.25A. The output voltage variation should be within 5%.
6. Use oscilloscope to observe output ripple voltage and phase node ringing. For accurate measurement, please refer to Figure 3 for proper probe set-up.
7. Optimization. Please refer to Table 2 on page 1 for optimization recommendation.
8. For 5V input applications, please tie the VCC5V to VIN and do not allow V_{IN} to go above 5.5V.

NOTE: Test points: VIN+, VIN-, VO+ and VO- are for voltage measurement only. Do not allow high current through these test points.

Probe Set-up

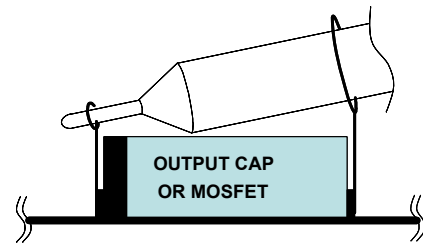

FIGURE 3. OSCILLOSCOPE PROBE SET-UP

VOUT Setting

The output voltage is set by the resistor divider, R_{13} and R_{22} .

$$V_{OUT} = \frac{R_{13} + R_{22}}{R_{13}} \times 0.6V \quad (\text{EQ. 1})$$

Resistor R_{21} is a resistor jumper for loop gain measurement. It is recommended to set $R_{21} = 50\Omega$ for loop gain measurement.

Component Selection

Component Voltage Stress

The controller, ISL8130 and input capacitors are connected from the VIN rail to GND. MOSFET, diode and the output capacitors are connected from the VOUT rail to GND. Please select component with sufficient voltage rating.

Inductor Selection

It is recommended to select inductor so that the ripple current ratio is between 30% to 50%. For low-core-loss magnetic material, higher ripple ratio would ease the compensation design

and help to reduce the size of the inductor. Please refer to Equation 2 for recommended inductor value:

$$L_{BST} = \frac{V_{OUT}}{\Delta I_R \times I_{Omax} \times F_{SW}} \times D \times (1 - D)^2 \quad (\text{EQ. 2})$$

Where D is the duty cycle, ΔI_R is the inductor ripple ratio.

It is recommended to select an inductor with a saturation current higher than the maximum overcurrent threshold.

Current Sensing:

For accurate overcurrent detection, it is recommended to set the voltage across the current sensing resistor, RCS, higher than 50mV. Taking variation into consideration, when precision current sensing resistor is used, $R_{SEN} = 665\Omega$.

The OC threshold should be higher than the peak inductor current at maximum load current. The maximum peak inductor usually occurs at V_{INmin} and can be calculated using Equation 3.

$$I_{LPK} = \frac{I_{Omax} \times V_{OUT}}{V_{INmin}} + \frac{1}{2} \times \frac{V_{INmin}}{L_{BST} \times F_{SW}} \times \left(1 - \frac{V_{INmin}}{V_{OUT}}\right) \quad (\text{EQ. 3})$$

Refer to Equation 4 for R_{CS} calculation.

$$R_{CS} < \frac{R_{SEN} \times I_{OCSET(min)}}{I_{LPK}} \quad (\text{EQ. 4})$$

Where: I_{OCSET} is the OCSET pin sinking current for overcurrent detection. The $I_{OCSET(min)} = 80\mu A$.

In "Inductor Selection" on page 2, it is recommended that the inductor saturation current be higher than the maximum overcurrent threshold. The maximum overcurrent threshold can be calculated by Equation 5.

$$I_{OCmax} = \frac{R_{SEN} \times I_{OCSET(max)}}{R_{CS}} \quad (\text{EQ. 5})$$

Where $I_{OCSET(max)} = 120\mu A$.

Input Capacitors

The input RMS current of a boost is much smaller than the output RMS in general. Please refer to Equation 6 for input RMS current calculation:

$$I_{INRMS} = \frac{V_{IN}}{L_{BST} \times F_{SW}} \times \left(1 - \frac{V_{IN}}{V_{OUT}}\right) \div (\sqrt{12}) \quad (\text{EQ. 6})$$

The bulk capacitor used is used to stabilize system stability and can be considered as the output capacitor of the input power supply.

Output Capacitors

It is recommended to use a combination of aluminum capacitors with high capacitance and low ESR ceramic capacitors at the output for optimum ripple and load transient performance.

The low ESL and ESR ceramic capacitors should be placed close to the MOSFET and diode.

When selecting the output capacitors, there are two important requirements: the ripple current and the stability.

The output RMS current worst case occurs at V_{IN_min} and maximum load. See Equation 7 for output ripple current calculation:

$$I_{ORMS} = I_{OUT} \times \sqrt{\frac{D_{max}}{1 - D_{max}}} \quad (\text{EQ. 7})$$

For example:

$$V_{OUT} = 32V, I_{OUT} = 1.25A, V_{INmin} = 6V$$

$$D_{max} = 81.25\%$$

$$I_{ORMS} = 2.6A$$

For applications with $F_{SW} < 1MHz$, it is still rule of thumb that the aluminum electrolytic capacitors take the ripple current. Please select electrolytic capacitors with ripple current greater than the maximum I_{ORMS} , as calculated by Equation 7.

The other important factor is stability. The right-half-plane zero, f_{RHP} of a boost converter imposes a big challenge for stability. It is recommended to set cross over frequency below the f_{RHP} and above the boost converter natural resonant frequency, f_N . It is recommended to use sufficient output capacitors so that the f_N is much lower than f_{RHP} . Equation 8 is provided for total output capacitance estimation.

$$C_{out} > \left(\frac{I_{Omax}}{V_{INmin}}\right)^2 \times L_{BST} \times 400 \quad (\text{EQ. 8})$$

where L_{BST} is the boost inductor.

For right-half-plane zero calculation, f_{RHP} :

$$f_{RHP} = \frac{V_{in}}{2\pi \times I_L \times L_{BST}} \quad (\text{EQ. 9})$$

For boost converter natural resonant frequency, f_N :

$$f_N = \frac{1 - D}{2\pi \times \sqrt{C_{OUT}} \times L_{BST}} \quad (\text{EQ. 10})$$

Output Disconnect

The boost converter cannot protect from an output short circuit event. It relies on the input power supply overcurrent protection or output disconnect circuit for output short circuit events.

Figure 4 is a simple output disconnect circuit, which can be used as a reference. The circuit is inserted between the cathode of the diode and the boost output.

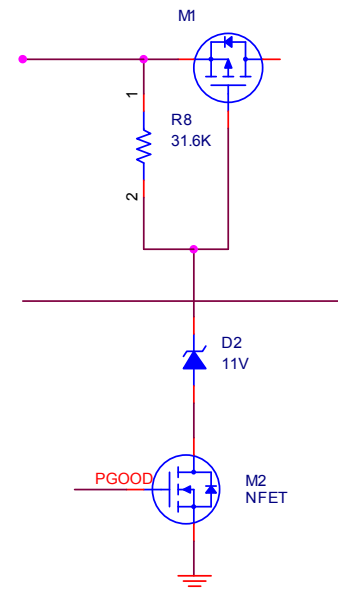

FIGURE 4. OUTPUT DISCONNECT CIRCUIT

Typical Performance Curves

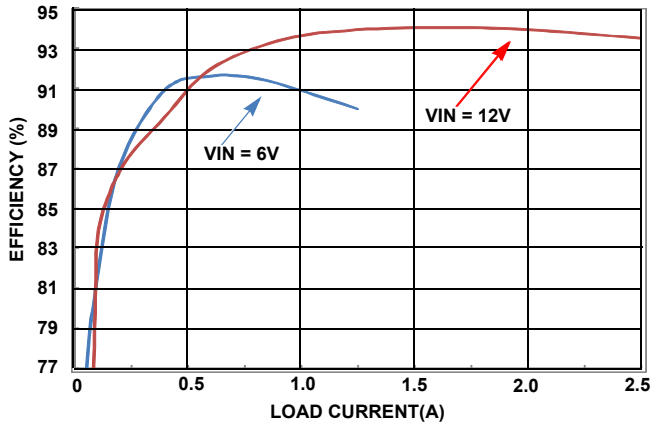

FIGURE 5. EFFICIENCY vs LOAD CURRENT

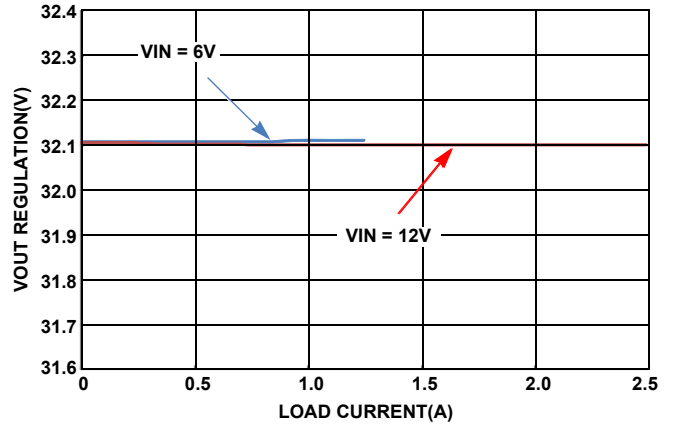

FIGURE 6. VOUT LOAD REGULATION

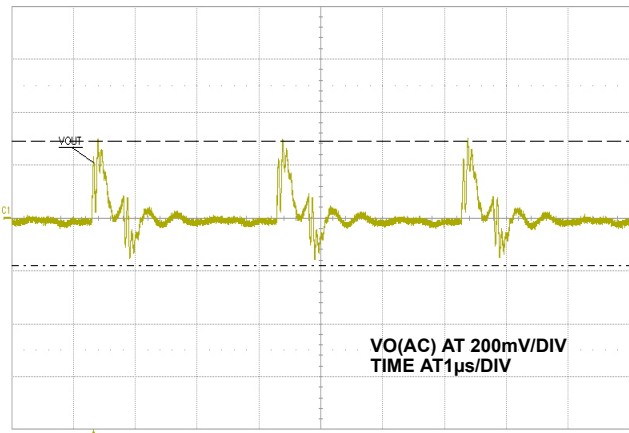

FIGURE 7. OUTPUT RIPPLE ($V_{IN} = 6V$, LOAD = 1.25A, 20MHz BW)

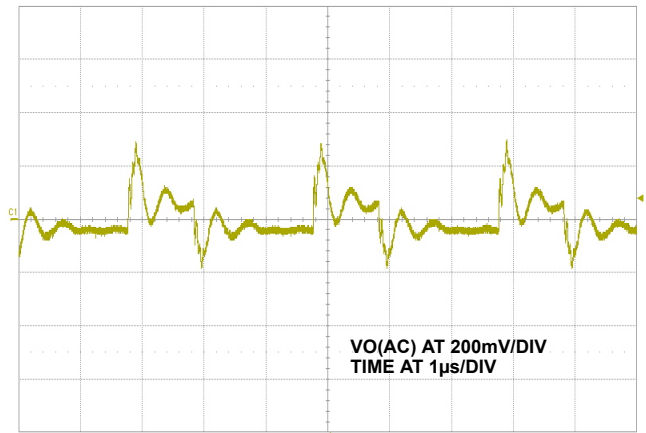

FIGURE 8. OUTPUT RIPPLE ($V_{IN} = 12V$, LOAD = 2.5A, 20MHz BW)

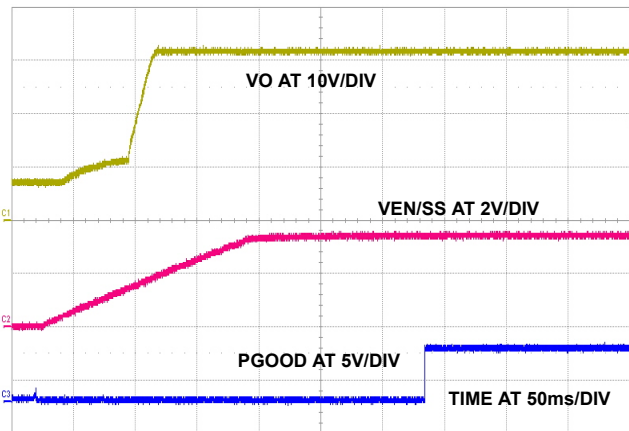

FIGURE 9. SOFT-START ($C_{SS} = 0.47\mu F$, $C_{DEL} = 0.1\mu F$)

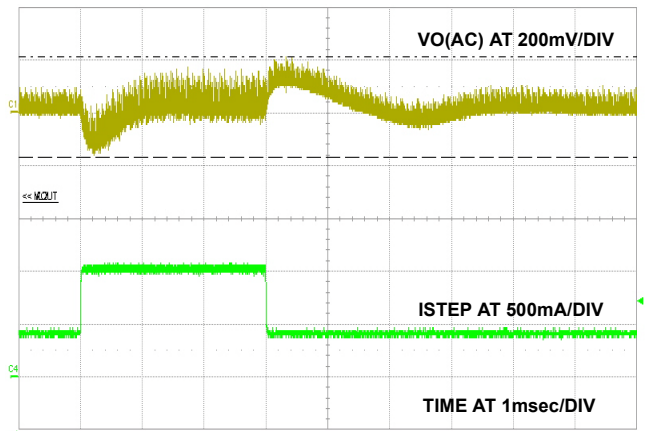

FIGURE 10. LOAD TRANSIENT ($V_{IN} = 12V$, LOADSTEP FROM 0.375A TO 1.0A)

Typical Performance Curves (Continued)

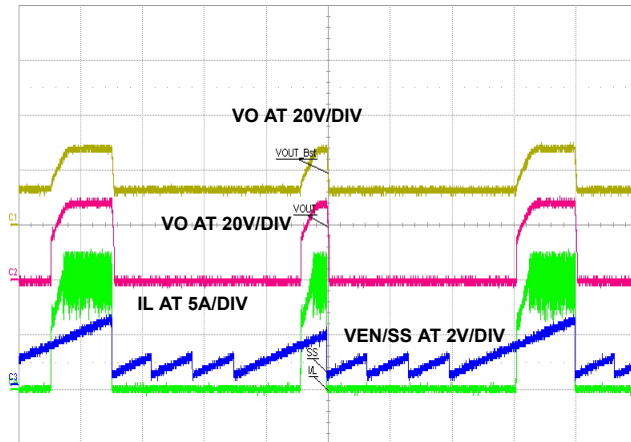
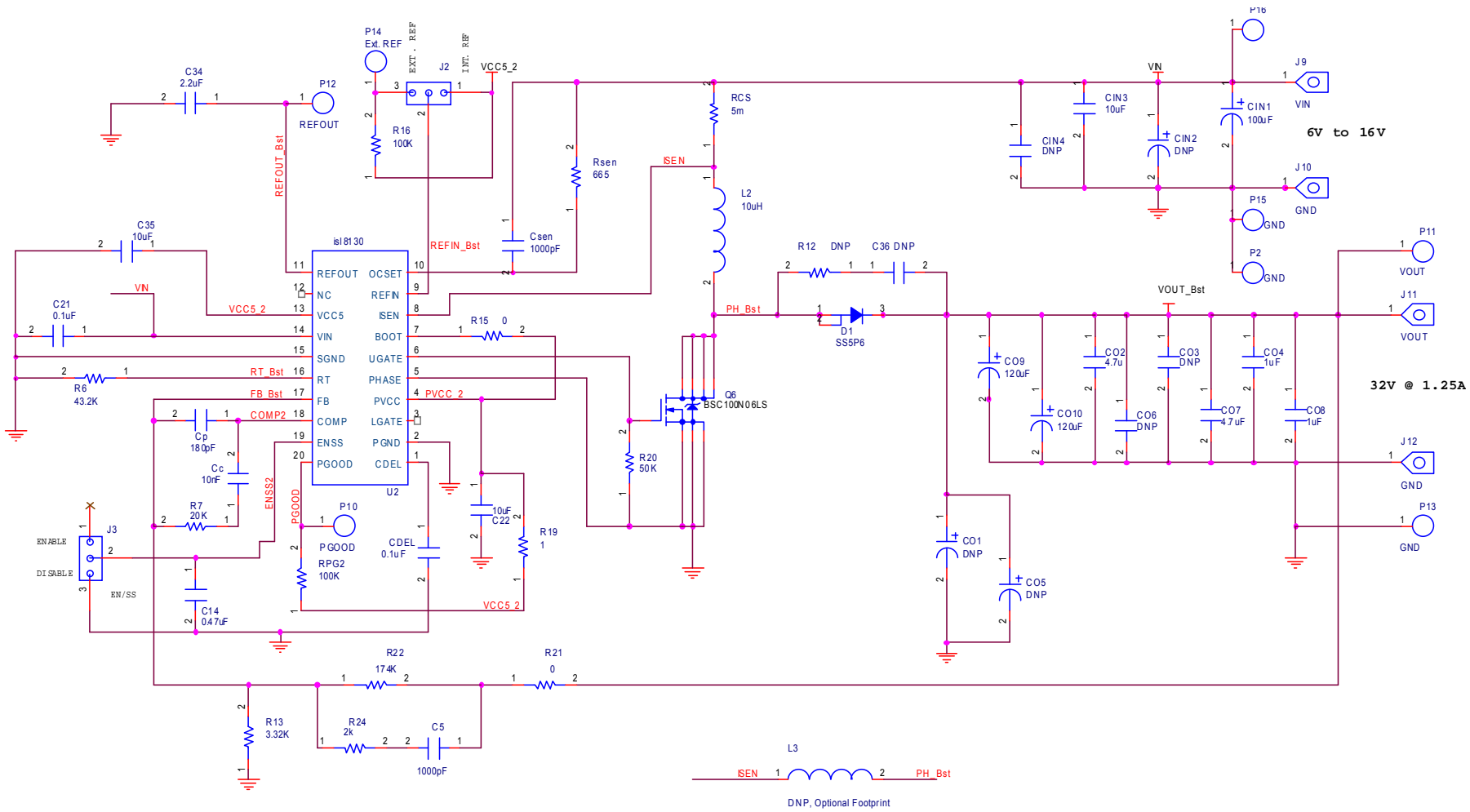

FIGURE 11. OVERCURRENT PROTECTION AT OVERLOAD WITH OUTPUT DISCONNECT (VBST IS THE OUTPUT BEFORE THE OUTPUT DISCONNECT FET. VO IS THE OUTPUT AFTER THE DISCONNECT FET)

Schematic



Disclaimer: THIS EVALUATION BOARD AND MATERIALS ARE PROVIDED 'AS-IS' FOR EVALUATION PURPOSES ONLY. INTERSIL CORPORATION AND ITS SUBSIDIARIES ('INTERISL') DISCLAIM ALL WARRANTIES, INCLUDING WITHOUT LIMITATION FITNESS FOR A PARTICULAR PURPOSE AND MERCHANTABILITY. Intersil provides the evaluation platform and design proposals to help our customers to develop products. However, factors beyond Intersil's control, including without limitation component variations, temperature changes and PCB layout, could significantly affect Intersil product performance. It remains the customers' responsibility to verify the actual circuit performance.

Bill of Materials

ITEM	QTY	REFERENCE	VALUE	DESCRIPTION	PART #	VENDOR
ESSENTIAL COMPONENTS						
1	1	CIN1	100 μ F	Alum. CAP, 35V	AVE107M35F24T-F	CDE
2	1	CIN3	10 μ F	Ceramic CAP, X5R, 25V, sm1206	Generic	Generic
3	1	C14	0.47 μ F	Ceramic CAP, X5R, 16V, sm0603	Generic	Generic
4	2	C21, CDEL	0.1 μ F	Ceramic CAP, X5R, 50V, sm0603	Generic	Generic
5	2	C22, C35	10 μ F	Ceramic CAP, X5R, 10V, sm0805	Generic	Generic
6	1	C34	2.2 μ F	Ceramic CAP, X5R, 16V, sm0805	Generic	Generic
7	2	C04, C08	1 μ F	Ceramic CAP, X5R, 50V, sm0805	Generic	Generic
8	2	C07, C02	4.7 μ F	Ceramic CAP, X5R, 50V, sm1206	Generic	Generic
9	1	Cc	10nF	Ceramic CAP, NP0 or C0G, sm0603	Generic	Generic
10	2	C5, Csen	1000pF	Ceramic CAP, NP0 or C0G, sm0603	Generic	Generic
11	1	Cp	180pF	Ceramic CAP, NP0 or C0G, sm0603	Generic	Generic
12	2	C09, C010	120 μ F	Alum. Cap, 50V, Radial 8 X 8 X 15	EEU-FR1H121L	Panasonic ECG
13	1	D1		Schottky Diode, 60V	SS5P6	Vishay
14	1	L2	10 μ H	Inductor	DR127-100-R	Cooper
15	1	Q6		Single Channel NFET, 60V	BSC100N06LS	Infineon
16	1	RCS	5m	Precision RES, sm2010, 1W	PMR50HZPJU5L0	ROHM
17	2	RPG2, R16	100k	Resistor, sm0603, 10%	Generic	Generic
18	1	Rsen	665	Resistor, sm0603, 1%	Generic	Generic
19	1	R6	43.2k	Resistor, sm0603, 1%	Generic	Generic
20	1	R7	20k	Resistor, sm0603, 1%	Generic	Generic
21	1	R13	3.32k	Resistor, sm0603, 1%	Generic	Generic
22	2	R15, R21	0	Resistor, sm0603, 10%	Generic	Generic
23	1	R19	1	Resistor, sm0603, 10%	Generic	Generic
24	1	R20	51k	Resistor, sm0603, 10%	Generic	Generic
25	1	R22	174k	Resistor, sm0603, 1%	Generic	Generic
26	1	R24	2k	Resistor, sm0603, 10%	Generic	Generic
27	1	U2		PWM Controller, 20L QSOP	ISL8130IAZ	Intersil
EVALUATION BOARD HARDWARE						
27	2	J10, J2		Banana Jack (Black)	111-0703-001	Emerson
28	2	J9, J11,		Banana Jack (Red)	111-0703-002	Emerson
29	2	J2, J3		1x3 Header	Generic	Generic
30	2	J2, J3		Connector Jumper	SPC02SYAN	Sullins
31	8	P2, P10, P11, P12, P13, P14, P15, P16,			1514-2	Keystone
OPTIONAL COMPONENTs						
32		CIN2, CIN4, C03, C06, C01, C05, C36, L3, R12	DO NOT POPULATE	N/A	N/A	N/A

ISL8130EV1Z PCB Layout

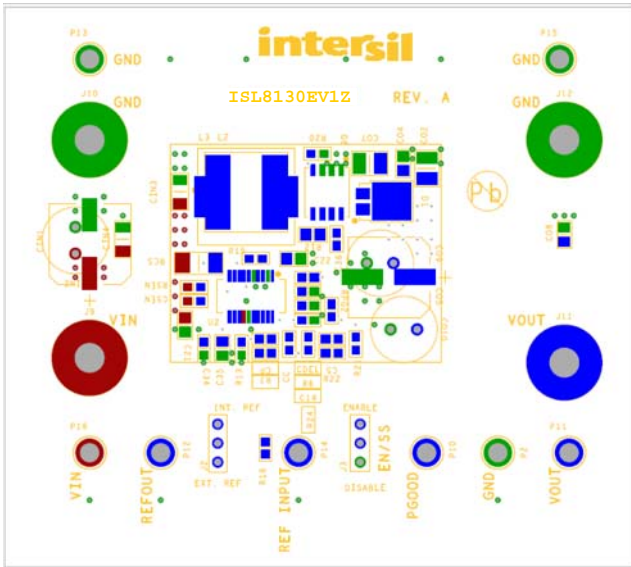

FIGURE 12. TOP SILKSCREEN

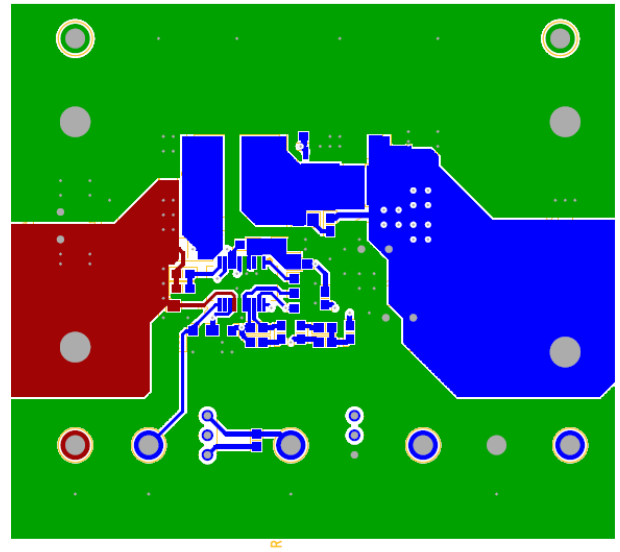

FIGURE 13. TOP LAYER

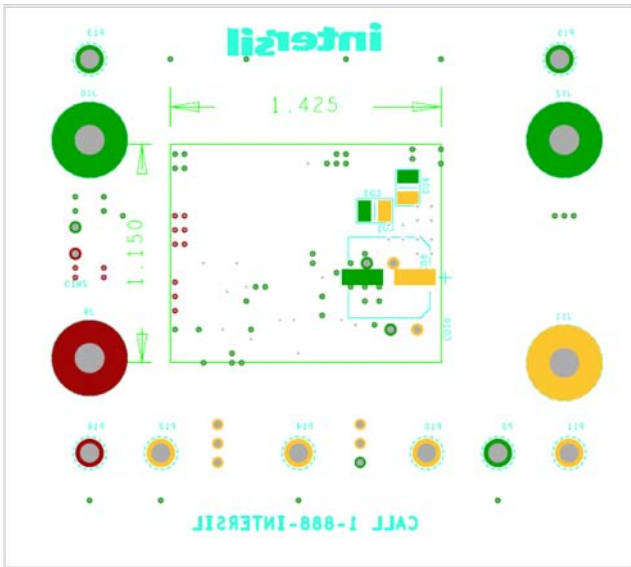

FIGURE 14. BOTTOM SILKSCREEN

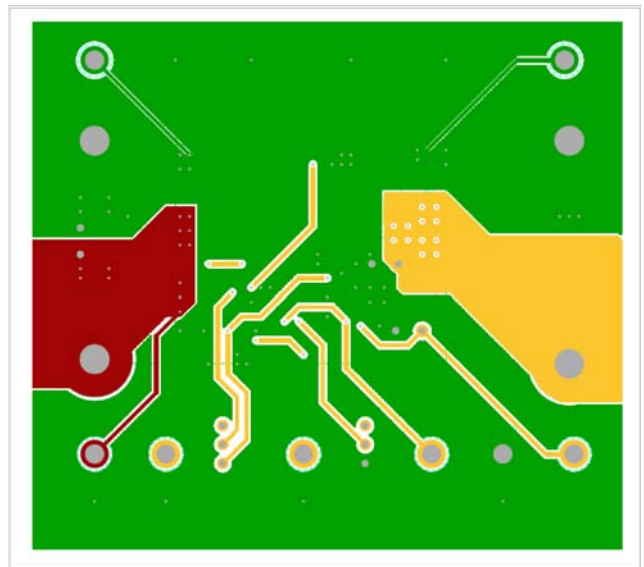

FIGURE 15. BOTTOM LAYER

Notice

1. Descriptions of circuits, software and other related information in this document are provided only to illustrate the operation of semiconductor products and application examples. You are fully responsible for the incorporation or any other use of the circuits, software, and information in the design of your product or system. Renesas Electronics disclaims any and all liability for any losses and damages incurred by you or third parties arising from the use of these circuits, software, or information.
2. Renesas Electronics hereby expressly disclaims any warranties against and liability for infringement or any other claims involving patents, copyrights, or other intellectual property rights of third parties, by or arising from the use of Renesas Electronics products or technical information described in this document, including but not limited to, the product data, drawings, charts, programs, algorithms, and application examples.
3. No license, express, implied or otherwise, is granted hereby under any patents, copyrights or other intellectual property rights of Renesas Electronics or others.
4. You shall not alter, modify, copy, or reverse engineer any Renesas Electronics product, whether in whole or in part. Renesas Electronics disclaims any and all liability for any losses or damages incurred by you or third parties arising from such alteration, modification, copying or reverse engineering.
5. Renesas Electronics products are classified according to the following two quality grades: "Standard" and "High Quality". The intended applications for each Renesas Electronics product depends on the product's quality grade, as indicated below.
"Standard": Computers; office equipment; communications equipment; test and measurement equipment; audio and visual equipment; home electronic appliances; machine tools; personal electronic equipment; industrial robots; etc.
"High Quality": Transportation equipment (automobiles, trains, ships, etc.); traffic control (traffic lights); large-scale communication equipment; key financial terminal systems; safety control equipment; etc.
Unless expressly designated as a high reliability product or a product for harsh environments in a Renesas Electronics data sheet or other Renesas Electronics document, Renesas Electronics products are not intended or authorized for use in products or systems that may pose a direct threat to human life or bodily injury (artificial life support devices or systems; surgical implantations; etc.), or may cause serious property damage (space system; undersea repeaters; nuclear power control systems; aircraft control systems; key plant systems; military equipment; etc.). Renesas Electronics disclaims any and all liability for any damages or losses incurred by you or any third parties arising from the use of any Renesas Electronics product that is inconsistent with any Renesas Electronics data sheet, user's manual or other Renesas Electronics document.
6. When using Renesas Electronics products, refer to the latest product information (data sheets, user's manuals, application notes, "General Notes for Handling and Using Semiconductor Devices" in the reliability handbook, etc.), and ensure that usage conditions are within the ranges specified by Renesas Electronics with respect to maximum ratings, operating power supply voltage range, heat dissipation characteristics, installation, etc. Renesas Electronics disclaims any and all liability for any malfunctions, failure or accident arising out of the use of Renesas Electronics products outside of such specified ranges.
7. Although Renesas Electronics endeavors to improve the quality and reliability of Renesas Electronics products, semiconductor products have specific characteristics, such as the occurrence of failure at a certain rate and malfunctions under certain use conditions. Unless designated as a high reliability product or a product for harsh environments in a Renesas Electronics data sheet or other Renesas Electronics document, Renesas Electronics products are not subject to radiation resistance design. You are responsible for implementing safety measures to guard against the possibility of bodily injury, injury or damage caused by fire, and/or danger to the public in the event of a failure or malfunction of Renesas Electronics products, such as safety design for hardware and software, including but not limited to redundancy, fire control and malfunction prevention, appropriate treatment for aging degradation or any other appropriate measures. Because the evaluation of microcomputer software alone is very difficult and impractical, you are responsible for evaluating the safety of the final products or systems manufactured by you.
8. Please contact a Renesas Electronics sales office for details as to environmental matters such as the environmental compatibility of each Renesas Electronics product. You are responsible for carefully and sufficiently investigating applicable laws and regulations that regulate the inclusion or use of controlled substances, including without limitation, the EU RoHS Directive, and using Renesas Electronics products in compliance with all these applicable laws and regulations. Renesas Electronics disclaims any and all liability for damages or losses occurring as a result of your noncompliance with applicable laws and regulations.
9. Renesas Electronics products and technologies shall not be used for or incorporated into any products or systems whose manufacture, use, or sale is prohibited under any applicable domestic or foreign laws or regulations. You shall comply with any applicable export control laws and regulations promulgated and administered by the governments of any countries asserting jurisdiction over the parties or transactions.
10. It is the responsibility of the buyer or distributor of Renesas Electronics products, or any other party who distributes, disposes of, or otherwise sells or transfers the product to a third party, to notify such third party in advance of the contents and conditions set forth in this document.
11. This document shall not be reprinted, reproduced or duplicated in any form, in whole or in part, without prior written consent of Renesas Electronics.
12. Please contact a Renesas Electronics sales office if you have any questions regarding the information contained in this document or Renesas Electronics products.
(Note 1) "Renesas Electronics" as used in this document means Renesas Electronics Corporation and also includes its directly or indirectly controlled subsidiaries.
(Note 2) "Renesas Electronics product(s)" means any product developed or manufactured by or for Renesas Electronics.

(Rev.4.0-1 November 2017)



SALES OFFICES

Renesas Electronics Corporation

<http://www.renesas.com>

Refer to "<http://www.renesas.com/>" for the latest and detailed information.

Renesas Electronics America Inc.
1001 Murphy Ranch Road, Milpitas, CA 95035, U.S.A.
Tel: +1-408-432-8888, Fax: +1-408-434-5351

Renesas Electronics Canada Limited
9251 Yonge Street, Suite 8309 Richmond Hill, Ontario Canada L4C 9T3
Tel: +1-905-237-2004

Renesas Electronics Europe Limited
Dukes Meadow, Millboard Road, Bourne End, Buckinghamshire, SL8 5FH, U.K
Tel: +44-1628-651-700, Fax: +44-1628-651-804

Renesas Electronics Europe GmbH
Arcadiastrasse 10, 40472 Düsseldorf, Germany
Tel: +49-211-6503-0, Fax: +49-211-6503-1327

Renesas Electronics (China) Co., Ltd.
Room 1709 Quantum Plaza, No.27 ZhichunLu, Haidian District, Beijing, 100191 P. R. China
Tel: +86-10-8235-1155, Fax: +86-10-8235-7679

Renesas Electronics (Shanghai) Co., Ltd.
Unit 301, Tower A, Central Towers, 555 Langao Road, Putuo District, Shanghai, 200333 P. R. China
Tel: +86-21-2226-0888, Fax: +86-21-2226-0999

Renesas Electronics Hong Kong Limited
Unit 1601-1611, 16/F., Tower 2, Grand Century Place, 193 Prince Edward Road West, Mongkok, Kowloon, Hong Kong
Tel: +852-2265-6688, Fax: +852-2886-9022

Renesas Electronics Taiwan Co., Ltd.
13F, No. 363, Fu Shing North Road, Taipei 10543, Taiwan
Tel: +886-2-8175-9600, Fax: +886-2-8175-9670

Renesas Electronics Singapore Pte. Ltd.
80 Bendemeer Road, Unit #06-02 Hyflux Innovation Centre, Singapore 339949
Tel: +65-6213-0200, Fax: +65-6213-0300

Renesas Electronics Malaysia Sdn.Bhd.
Unit 1207, Block B, Menara Amcorp, Amcorp Trade Centre, No. 18, Jln Persiaran Barat, 46050 Petaling Jaya, Selangor Darul Ehsan, Malaysia
Tel: +60-3-7955-9390, Fax: +60-3-7955-9510

Renesas Electronics India Pvt. Ltd.
No.777C, 100 Feet Road, HAL 2nd Stage, Indiranagar, Bangalore 560 038, India
Tel: +91-80-67208700, Fax: +91-80-67208777

Renesas Electronics Korea Co., Ltd.
17F, KAMCO Yangjae Tower, 262, Gangnam-daero, Gangnam-gu, Seoul, 06265 Korea
Tel: +82-2-558-3737, Fax: +82-2-558-5338



Компания «ЭлектроПласт» предлагает заключение долгосрочных отношений при поставках импортных электронных компонентов на взаимовыгодных условиях!

Наши преимущества:

- Оперативные поставки широкого спектра электронных компонентов отечественного и импортного производства напрямую от производителей и с крупнейших мировых складов;
- Поставка более 17-ти миллионов наименований электронных компонентов;
- Поставка сложных, дефицитных, либо снятых с производства позиций;
- Оперативные сроки поставки под заказ (от 5 рабочих дней);
- Экспресс доставка в любую точку России;
- Техническая поддержка проекта, помощь в подборе аналогов, поставка прототипов;
- Система менеджмента качества сертифицирована по Международному стандарту ISO 9001;
- Лицензия ФСБ на осуществление работ с использованием сведений, составляющих государственную тайну;
- Поставка специализированных компонентов (Xilinx, Altera, Analog Devices, Intersil, Interpoint, Microsemi, Aeroflex, Peregrine, Syfer, Eurofarad, Texas Instrument, Miteq, Cobham, E2V, MA-COM, Hittite, Mini-Circuits, General Dynamics и др.);

Помимо этого, одним из направлений компании «ЭлектроПласт» является направление «Источники питания». Мы предлагаем Вам помощь Конструкторского отдела:

- Подбор оптимального решения, техническое обоснование при выборе компонента;
- Подбор аналогов;
- Консультации по применению компонента;
- Поставка образцов и прототипов;
- Техническая поддержка проекта;
- Защита от снятия компонента с производства.



Как с нами связаться

Телефон: 8 (812) 309 58 32 (многоканальный)

Факс: 8 (812) 320-02-42

Электронная почта: org@eplast1.ru

Адрес: 198099, г. Санкт-Петербург, ул. Калинина, дом 2, корпус 4, литера А.