

### RA Varistor Series



#### Agency Approvals

| Agency  | Agency Approval | Agency File Number |
|---|-----------------|--------------------|
|  | UL1449          | E320116            |

#### Additional Information



Datasheet



Resources



Samples

#### Description

The RA Series transient surge suppressors are varistors (MOVs) supplied in a low-profile box that features a precise seating plane to increase mechanical stability for secure circuit-board mounting. This feature makes these devices suitable for industrial applications critical to vibration. Their construction permits operation up to 125°C (ambient) without derating.

The RA Series are available in voltage ratings up to 275V  $V_{M(AC)RMS}$  and energy levels up to 140J. These varistors are used in automotive, motor-control, telecommunication, and military applications.

See RA Series Device Ratings and Specifications Table for part number and brand information.

#### Features

- Lead-free/RoHS compliant parts available (add suffix "x2749")
- Low profile outline with precise seating plane
- No derating up to 125°C ambient
- In-line leads
- Wide operating voltage range:  
 $V_{M(AC)RMS}$ : 4 – 275V  
 $V_{M(DC)}$ : 5.5 – 369V
- High energy absorption capability  $W_{TM}$  up to 140J
- 3 model sizes available A8, RA16, and RA22

#### Absolute Maximum Ratings

• For ratings of individual members of a series, see Device Ratings and Specifications chart

| Continuous   | RA8 Series  | RA16 Series  | RA22 Series  | Units      |
|--|-------------|--------------|--------------|------------|
| Steady State Applied Voltage:  |             |              |              |            |
| AC Voltage Range ( $V_{M(AC)RMS}$ )  | 4 to 275    | 10 to 275    | 4 to 275     | V          |
| DC Voltage Range ( $V_{M(DC)}$ )   | 5.5 to 369  | 14 to 369    | 18 to 369    | V          |
| Transients:  |             |              |              |            |
| Peak Pulse Current ( $I_{TM}$ )  |             |              |              |            |
| For 8/20 $\mu$ s Current Wave (See Figure 2)   | 100 to 1200 | 1000 to 4500 | 2000 to 6500 | A          |
| Single Pulse Energy Range (Note 1)   |             |              |              |            |
| For 10/1000 $\mu$ s Current Wave ( $W_{TM}$ )  | 0.4 to 23   | 3.5 to 75    | 70 to 160    | J          |
| Operating Ambient Temperature Range ( $T_A$ )  | -55 to +125 | -55 to +125  | -55 to +125  | °C         |
| Storage Temperature Range ( $T_{STG}$ )  | -55 to +150 | -55 to +150  | -55 to +150  | °C         |
| Temperature Coefficient ( $\alpha$ ) of Clamping Voltage ( $V_C$ ) at Specified Test Current   | <0.01       | <0.01        | <0.01        | %/°C       |
| Hi-Pot Encapsulation (COATING Isolation Voltage Capability)<br>(Dielectric must withstand indicated DC voltage for one minute per MIL-STD 202, Method 301) | 5000        | 5000         | 5000         | V          |
| COATING Insulation Resistance  | 1000        | 1000         | 1000         | M $\Omega$ |

**CAUTION:** Stresses above those listed in "Absolute Maximum Ratings" may cause permanent damage to the device. This is a stress only rating and operation of the device at these or any other conditions above those indicated in the operational sections of this specification is not implied.

### RA Series Ratings & Specifications

| Part Number          | Brand  | Maximum Rating (125°C) |             |                          |                             | Specifications (25°C)                   |             |       |  |       |                     |
|----------------------|--------|------------------------|-------------|--------------------------|-----------------------------|---|-------------|-------|--|-------|---------------------|
|                      |        | Continuous             |             | Transient                |                             | Varistor Voltage at 1mA DC Test Current |             |       | Max Clamping Volt $V_C$ (8/20 $\mu$ s) |       | Typical Capacitance |
|                      |        | $V_{RMS}$              | $V_{DC}$    | Energy (10/1000 $\mu$ s) | Peak Current (8/20 $\mu$ s) |   |             |       |  |       |                     |
|                      |        | $V_{M(AC)}$            | $V_{M(DC)}$ | $W_{TM}$                 | $I_{TM}$                    | Min                                     | $V_{N(DC)}$ | Max   | $V_C$                                  | $I_P$ | f = 1MHz            |
| (mm)                 | (V)    | (V)                    | (J)         | (A)                      | (V)                         | (V)                                     | (V)         | (V)   | (A)                                    | (pF)  |                     |
| <b>† RA8 Series</b>  |        |                        |             |                          |                             |   |             |       |  |       |                     |
| V8RA8                | 8R     | 4                      | 5.5         | 0.4                      | 150                         | 6                                       | 8.6         | 11.2  | 22                                     | 5     | 3000                |
| V12RA8               | 12R    | 6                      | 8           | 0.6                      | 150                         | 9                                       | 12.5        | 16    | 34                                     | 5     | 2500                |
| V18RA8               | 18R    | 10                     | 14          | 0.8                      | 250                         | 16.2                                    | 18          | 19.8  | 42                                     | 5     | 2000                |
| V22RA8               | 22R    | 14                     | 18 (Note 3) | 10 (Note 2)              | 250                         | 19.8                                    | 22          | 24.2  | 47                                     | 5     | 1600                |
| V27RA8               | 27R    | 17                     | 22          | 1.0                      | 250                         | 24.3                                    | 27          | 29.7  | 57                                     | 5     | 1300                |
| V33RA8               | 33R    | 20                     | 26          | 1.2                      | 250                         | 29.7                                    | 33          | 36.3  | 68                                     | 5     | 1100                |
| V39RA8               | 39R    | 25                     | 31          | 1.5                      | 250                         | 35.1                                    | 39          | 42.9  | 79                                     | 5     | 900                 |
| V47RA8               | 47R    | 30                     | 38          | 1.8                      | 250                         | 42.3                                    | 47          | 51.7  | 92                                     | 5     | 800                 |
| V56RA8               | 56R    | 35                     | 45          | 2.3                      | 250                         | 50.4                                    | 56          | 61.6  | 107                                    | 5     | 700                 |
| V68RA8               | 68R    | 40                     | 56          | 3.0                      | 250                         | 61.2                                    | 68          | 74.8  | 127                                    | 5     | 600                 |
| V82RA8               | 82R    | 50                     | 66          | 4.0                      | 1200                        | 73.8                                    | 82          | 90.2  | 135                                    | 10    | 500                 |
| V100RA8              | 100R   | 60                     | 81          | 5.0                      | 1200                        | 90                                      | 100         | 110   | 165                                    | 10    | 400                 |
| V120RA8              | 120R   | 75                     | 102         | 6.0                      | 1200                        | 108                                     | 120         | 132   | 205                                    | 10    | 300                 |
| V150RA8              | 150R   | 95                     | 127         | 8.0                      | 1200                        | 135                                     | 150         | 165   | 250                                    | 10    | 250                 |
| V180RA8              | 180R   | 115                    | 153         | 10.0                     | 1200                        | 162                                     | 180         | 198   | 295                                    | 10    | 200                 |
| V200RA8              | 200R   | 130                    | 175         | 11.0                     | 1200                        | 184.5                                   | 205         | 225.5 | 340                                    | 10    | 180                 |
| † V220RA8            | 220R   | 140                    | 180         | 12.0                     | 1200                        | 198                                     | 220         | 242   | 360                                    | 10    | 160                 |
| † V240RA8            | 240R   | 150                    | 200         | 13.0                     | 1200                        | 216                                     | 240         | 264   | 395                                    | 10    | 150                 |
| † V270RA8            | 270R   | 175                    | 225         | 15.0                     | 1200                        | 243                                     | 270         | 297   | 455                                    | 10    | 130                 |
| † V360RA8            | 360R   | 230                    | 300         | 20.0                     | 1200                        | 324                                     | 360         | 396   | 595                                    | 10    | 100                 |
| † V390RA8            | 390R   | 250                    | 330         | 21.0                     | 1200                        | 351                                     | 390         | 429   | 650                                    | 10    | 90                  |
| † V430RA8            | 430R   | 275                    | 369         | 23.0                     | 1200                        | 387                                     | 430         | 473   | 710                                    | 10    | 80                  |
| <b>† RA16 Series</b> |        |                        |             |                          |                             |   |             |       |  |       |                     |
| V18RA16              | 18R16  | 10                     | 14          | 3.5                      | 1000                        | 16.2                                    | 18          | 19.8  | 39                                     | 10    | 11000               |
| V22RA16              | 22R16  | 14                     | 18 (Note 3) | 50 (Note 2)              | 1000                        | 19.8                                    | 22          | 24.2  | 43                                     | 10    | 9000                |
| V27RA16              | 27R16  | 17                     | 22          | 5.0                      | 1000                        | 24.3                                    | 27          | 29.7  | 53                                     | 10    | 7000                |
| V33RA16              | 33R16  | 20                     | 26          | 6.0                      | 1000                        | 29.7                                    | 33          | 36.3  | 64                                     | 10    | 6000                |
| V39RA16              | 39R16  | 25                     | 31          | 7.2                      | 1000                        | 35.1                                    | 39          | 42.9  | 76                                     | 10    | 5000                |
| V47RA16              | 47R16  | 30                     | 38          | 8.8                      | 1000                        | 42.3                                    | 47          | 51.7  | 89                                     | 10    | 4500                |
| V56RA16              | 56R16  | 35                     | 45          | 10.0                     | 1000                        | 50.4                                    | 56          | 61.6  | 103                                    | 10    | 3900                |
| V68RA16              | 68R16  | 40                     | 56          | 13.0                     | 1000                        | 61.2                                    | 68          | 74.8  | 123                                    | 10    | 3300                |
| V82RA16              | 82R16  | 50                     | 66          | 15.0                     | 4500                        | 73.8                                    | 82          | 90.2  | 145                                    | 50    | 2500                |
| V100RA16             | 100R16 | 60                     | 81          | 20.0                     | 4500                        | 90                                      | 100         | 110   | 175                                    | 50    | 2000                |
| V120RA16             | 120R16 | 75                     | 102         | 22.0                     | 4500                        | 108                                     | 120         | 132   | 205                                    | 50    | 1700                |
| V150RA16             | 150R16 | 95                     | 127         | 30.0                     | 4500                        | 135                                     | 150         | 165   | 255                                    | 50    | 1400                |
| V180RA16             | 180R16 | 115                    | 153         | 35.0                     | 4500                        | 162                                     | 180         | 198   | 300                                    | 50    | 1100                |
| V200RA16             | 200R16 | 130                    | 175         | 38.0                     | 4500                        | 184.5                                   | 205         | 225.5 | 340                                    | 50    | 1000                |
| † V220RA16           | 220R16 | 140                    | 180         | 42.0                     | 4500                        | 198                                     | 220         | 242   | 360                                    | 50    | 900                 |
| † V240RA16           | 240R16 | 150                    | 200         | 45.0                     | 4500                        | 216                                     | 240         | 264   | 395                                    | 50    | 800                 |
| † V270RA16           | 270R16 | 175                    | 225         | 55.0                     | 4500                        | 243                                     | 270         | 297   | 455                                    | 50    | 700                 |
| † V360RA16           | 360R16 | 230                    | 300         | 70.0                     | 4500                        | 324                                     | 360         | 396   | 595                                    | 50    | 550                 |
| † V390RA16           | 390R16 | 250                    | 330         | 72.0                     | 4500                        | 351                                     | 390         | 429   | 650                                    | 50    | 500                 |
| † V430RA16           | 430R16 | 275                    | 369         | 75.0                     | 4500                        | 387                                     | 430         | 473   | 710                                    | 50    | 450                 |

### RA Series Ratings & Specifications

| Part Number          | Brand  | Maximum Rating (125°C) |             |                          |                             | Specifications (25°C)                   |             |       |  |       |                     |
|----------------------|--------|------------------------|-------------|--------------------------|-----------------------------|---|-------------|-------|--|-------|---------------------|
|                      |        | Continuous             |             | Transient                |                             | Varistor Voltage at 1mA DC Test Current |             |       | Max Clamping Volt $V_C$ (8/20 $\mu$ s) |       | Typical Capacitance |
|                      |        | $V_{RMS}$              | $V_{DC}$    | Energy (10/1000 $\mu$ s) | Peak Current (8/20 $\mu$ s) |   |             |       |  |       |                     |
|                      |        | $V_{M(AC)}$            | $V_{M(DC)}$ | $W_{TM}$                 | $I_{TM}$                    | Min                                     | $V_{N(DC)}$ | Max   | $V_C$                                  | $I_P$ | f = 1MHz            |
| (mm)                 | (V)    | (V)                    | (J)         | (A)                      | (V)                         | (V)                                     | (V)         | (V)   | (A)                                    | (pF)  |                     |
| <b>† RA22 Series</b> |        |                        |             |                          |                             |   |             |       |  |       |                     |
| V24RA22              | 24R22  | 14                     | 18 (Note 3) | 100.0 (Note 2)           | 2000                        | 21.6                                    | 24          | 26.4  | 43                                     | 20    | 18000               |
| V36RA22              | 36R22  | 23                     | 31          | 160.0 (Note 2)           | 2000                        | 32.4                                    | 36          | 39.6  | 63                                     | 20    | 12000               |
| † V200RA22           | 200R22 | 130                    | 175         | 70.0                     | 6500                        | 184.5                                   | 205         | 225.5 | 340                                    | 100   | 1900                |
| † V240RA22           | 240R22 | 150                    | 200         | 80.0                     | 6500                        | 216                                     | 240         | 264   | 395                                    | 100   | 1600                |
| † V270RA22           | 270R22 | 175                    | 225         | 90.0                     | 6500                        | 243                                     | 270         | 297   | 455                                    | 100   | 1400                |
| † V390RA22           | 390R22 | 250                    | 330         | 130.0                    | 6500                        | 351                                     | 390         | 429   | 650                                    | 100   | 1000                |
| † V430RA22           | 430R22 | 275                    | 369         | 140.0                    | 6500                        | 387                                     | 430         | 473   | 710                                    | 100   | 900                 |

- NOTES:
1. Average power dissipation of transients not to exceed 0.25W for RA8 Series, 0.60W for RA16 Series, or 1.0W for RA22 Series.
  2. Energy ratings for impulse duration of 30ms minimum to one half of peak current value.
  3. Also rated to withstand 24V for 5 minutes.
  4. 10mA DC Test Current.
- † Under UL File No. E320116 as a recognized component. CSA approved File No. 91788.

### Power Dissipation Ratings



Should transients occur in rapid succession, the average power dissipation required is simply the energy (watt-seconds) per pulse times the number of pulses per second. The power so developed must be within the specifications shown on the Device Ratings and Specifications table for the specific device. Furthermore, the operating values need to be derated at high temperatures as shown above. Because varistors can only dissipate a relatively small amount of average power they are, therefore, not suitable for repetitive applications that involve substantial amounts of average power dissipation.

### Peak Pulse Current Test Waveform



- $0_1$  = Virtual Origin of Wave
- $T$  = Time from 10% to 90% of Peak
- $T_1$  = Rise Time =  $1.25 \times T$
- $T_2$  = Decay Time

**Example** - For an 8/20  $\mu$ s Current Waveform:

- $8\mu s = T_1$  = Rise Time
- $20\mu s = T_2$  = Decay Time

**Maximum Clamping Voltage for 8mm Parts**

**V8RA8 - V68RA8**

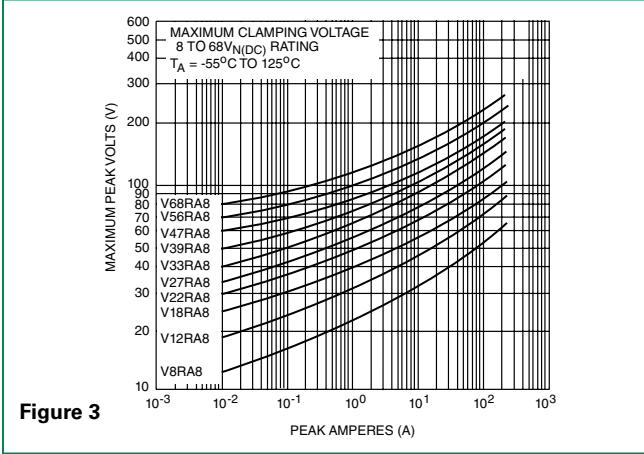

**Figure 3**

**Repetitive Surge Capability for 8mm Parts**

**V8RA8 - V12RA8**

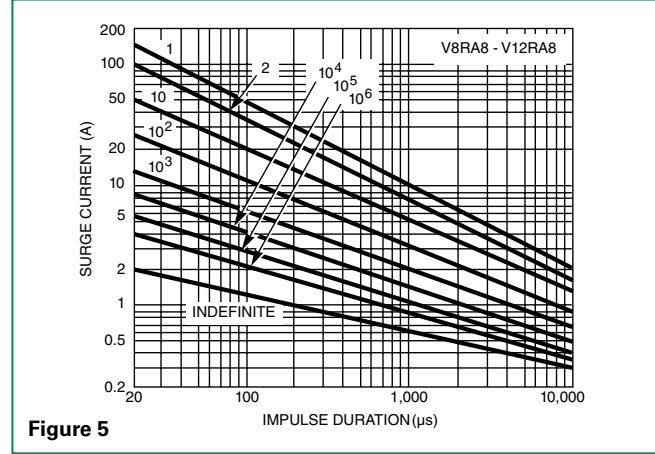

**Figure 5**

**V82RA8 - V430RA8**



**Figure 4**

**V18RA8 - V68RA8**



**Figure 6**

**V82RA8 - V430RA8**



**Figure 7**

**Maximum Clamping Voltage for 16mm Parts**

V18RA16 - V68RA16

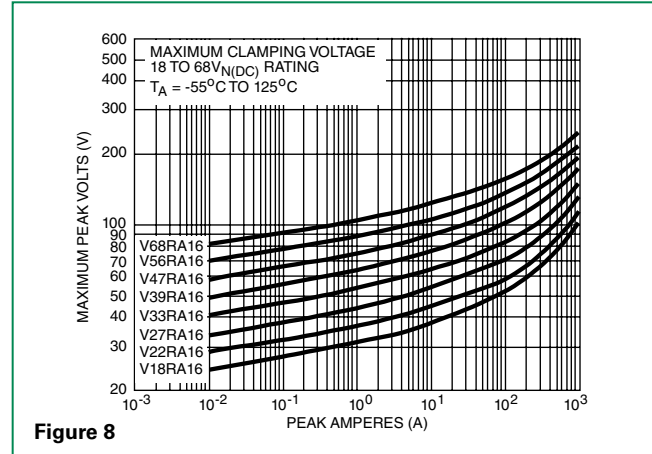

Figure 8

**Repetitive Surge Capability for 16mm Parts**

V18RA16 - V68RA16

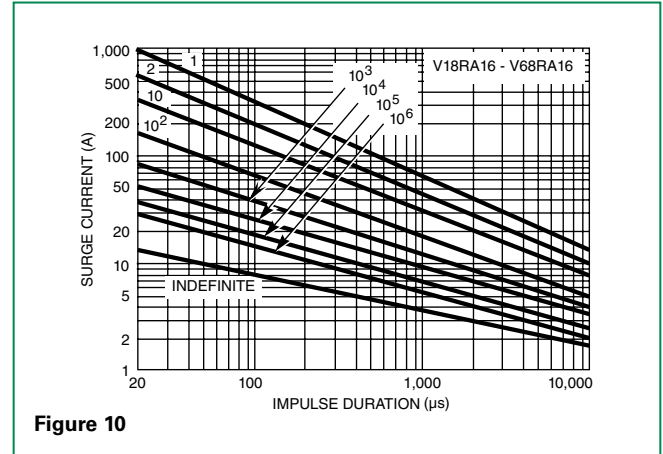

Figure 10

V82RA16 - V430RA16

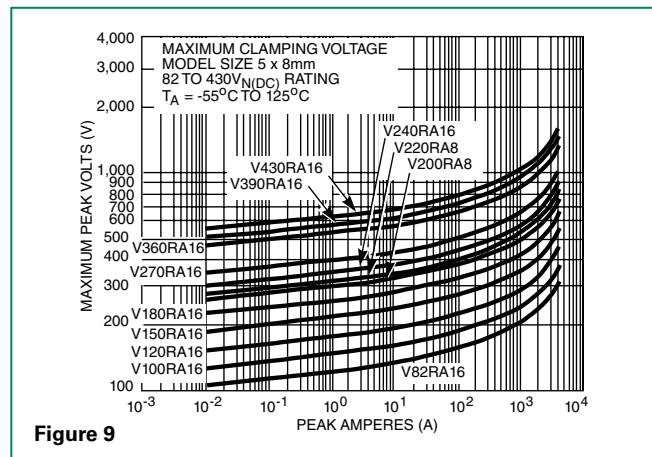

Figure 9

V82RA16 - V430RA16

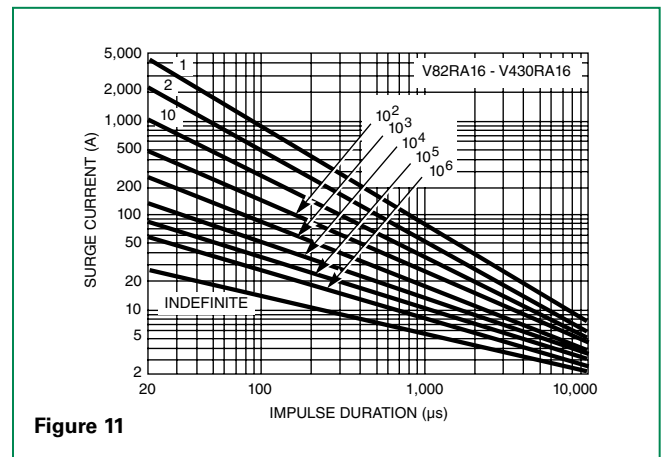

Figure 11

**Maximum Clamping Voltage for 22mm Parts**

V24RA22 - V36RA22



Figure 12

**Repetitive Surge Capability for 22mm Parts**

V24RA22 - V36RA22

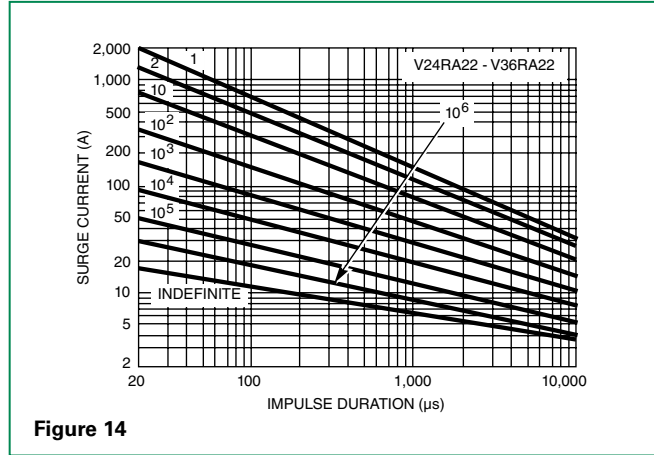

Figure 14

V200RA22 - V430RA22

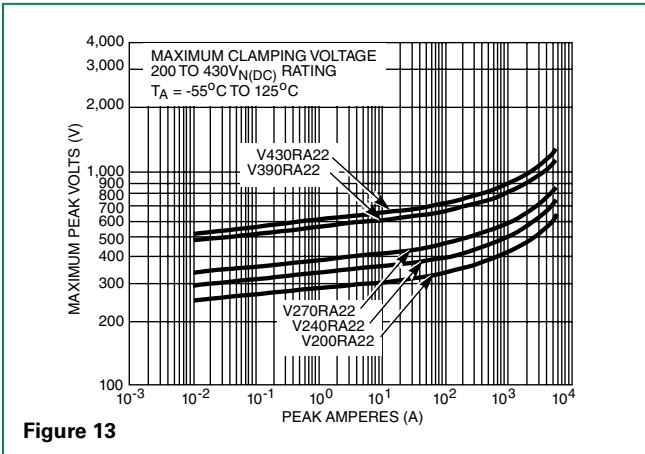

Figure 13

V200RA22 - V430RA22

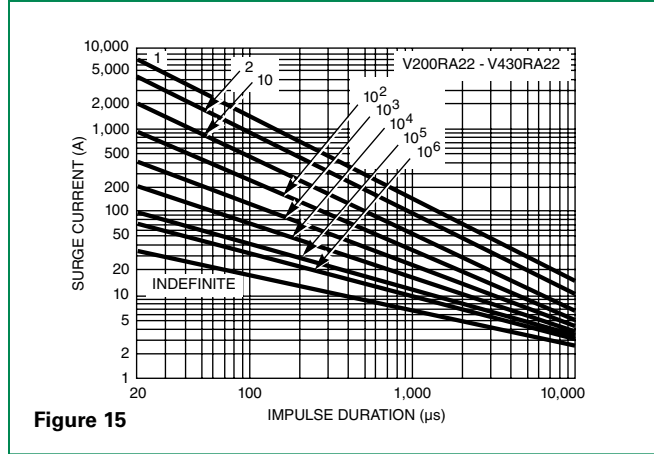

Figure 15

NOTE: If pulse ratings are exceeded, a shift of  $V_{N(DC)}$  (at specified current) of more than  $\pm 10\%$  could result. This type of shift, which normally results in a decrease of  $V_{N(DC)}$ , may result in the device not meeting the original published specifications, but it does not prevent the device from continuing to function, and to provide ample protection.

**Wave Solder Profile**

|   |                               |                    |
|---|-------------------------------|--------------------|
| Reflow Condition                                  |                               | Pb – Free assembly |
| Pre Heat  | - Temperature Min (Ts(min))   | 150°C              |
|   | - Temperature Max (Ts(max))   | 200°C              |
|   | - Time (min to max) (ts)      | 60 – 180 secs      |
| Average ramp-up rate (Liquidus Temp (TL) to peak) |                               | 5°C/second max     |
| TS(max) to TL - Ramp-up Rate                      |                               | 5°C/second max     |
| Reflow  | - Temperature (TL) (Liquidus) | 217°C              |
|   | - Temperature (tL)            | 60 – 150 seconds   |
| Peak Temperature (TP)                             |                               | 250+0/-5°C         |
| Time within 5°C of actual peak Temperature (tp)   |                               | 20 – 40 seconds    |
| Ramp-down Rate                                    |                               | 5°C/second max     |
| Time 25°C to peak Temperature (TP)                |                               | 8 minutes Max.     |
| Do not exceed                                     |                               | 260°C              |

**Lead-free Profile**



**Non Lead-free Profile**



**Environmental Specifications**

|                                      |   |
|--------------------------------------|---|
| <b>Operating/Storage Temperature</b> | -55°C to +125°C / -55°C to +150°C           |
| <b>Humidity Aging</b>                | +85°C, 85% RH, 1000 hours<br>+/-10% Voltage |
| <b>Thermal Shock</b>                 | +85°C to -40°C 10 times<br>+/-10% Voltage   |
| <b>Solvent Resistance</b>            | MIL-STD-202, Method 215                     |
| <b>Moisture Sensitivity</b>          | Level 1, J-STD-020                          |

**Physical Specifications**

|                                  |  |
|----------------------------------|--|
| <b>Lead Material</b>             | Tin-Coated   |
| <b>Soldering Characteristics</b> | Solderability per MIL-STD-202, Method 208                        |
| <b>Insulating Material</b>       | Cured, flame retardant epoxy polymer meets UL94V-0 requirements. |
| <b>Device Labeling</b>           | Marked with LF, voltage, amperage rating, and date code.         |

**Product Dimensions (mm)**

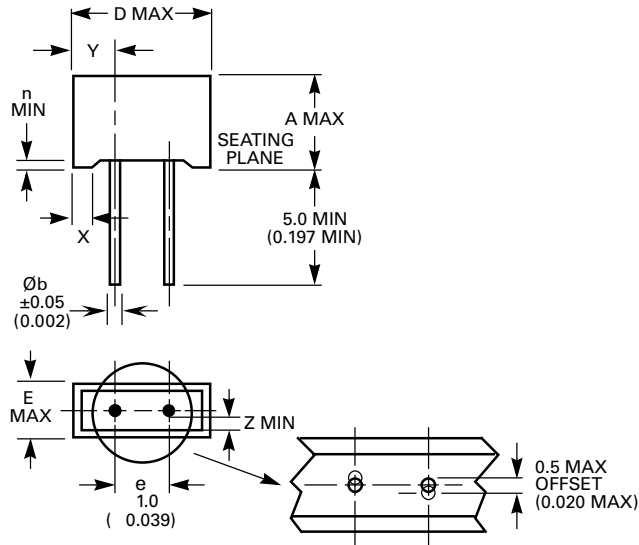

| SYMBOL                     | RA8 Series                      | RA16 Series                 | RA22 Series                  |
|----------------------------|---------------------------------|-----------------------------|------------------------------|
| <b>A</b> (max.)            | 8.85<br>(0.348)                 | 15.1<br>(0.594)             | 19.1<br>(0.752)              |
| <b>D</b> (max.)            | 11.45<br>(0.450)                | 19.7<br>(0.776)             | 25.5<br>(1.004)              |
| <b>e ± 1</b>               | 5<br>(0.197)                    | 7.5<br>(0.295)              | 7.5<br>(0.295)               |
| <b>E</b> (max.)            | 5.2<br>(0.205)                  | 6.3<br>(0.248)              | 6.3<br>(0.248)               |
| <b>n</b> (max.)            | 0.7<br>(0.027)                  | 0.7<br>(0.027)              | 0.7<br>(0.027)               |
| <b>Øb ± 0.05</b>           | 0.635<br>(0.025)                | 0.81<br>(0.032)             | 0.81<br>(0.032)              |
| <b>Weight</b><br>(typical) | 1 Gram                          | 3.4 Grams                   | 4.4 Grams                    |
| <b>X</b>                   | 2.2<br>(0.087)                  | 2.2<br>(0.087)              | 4.4<br>(0.173)               |
| <b>Y (Typ.)</b>            | 3.1 -/+ 0.5<br>(0.122 -/+ 0.02) | 6 -/+ 1<br>(0.236 -/+ 0.04) | 8.9 -/+ 1<br>(0.35 -/+ 0.04) |
| <b>Z</b> (min.)            | 0.4<br>(0.015)                  | 0.8<br>(0.031)              | 0.8<br>(0.031)               |

NOTES: Dimensions are in mm, with dimensions in inches in parentheses.  
Inches for reference only.

**Part Numbering System**

The RA Series is supplied in bulk pack.

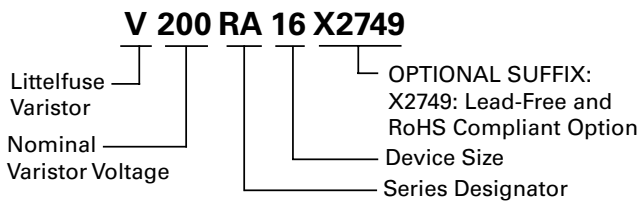





Компания «ЭлектроПласт» предлагает заключение долгосрочных отношений при поставках импортных электронных компонентов на взаимовыгодных условиях!

Наши преимущества:

- Оперативные поставки широкого спектра электронных компонентов отечественного и импортного производства напрямую от производителей и с крупнейших мировых складов;
- Поставка более 17-ти миллионов наименований электронных компонентов;
- Поставка сложных, дефицитных, либо снятых с производства позиций;
- Оперативные сроки поставки под заказ (от 5 рабочих дней);
- Экспресс доставка в любую точку России;
- Техническая поддержка проекта, помощь в подборе аналогов, поставка прототипов;
- Система менеджмента качества сертифицирована по Международному стандарту ISO 9001;
- Лицензия ФСБ на осуществление работ с использованием сведений, составляющих государственную тайну;
- Поставка специализированных компонентов (Xilinx, Altera, Analog Devices, Intersil, Interpoint, Microsemi, Aeroflex, Peregrine, Syfer, Eurofarad, Texas Instrument, Miteq, Cobham, E2V, MA-COM, Hittite, Mini-Circuits, General Dynamics и др.);

Помимо этого, одним из направлений компании «ЭлектроПласт» является направление «Источники питания». Мы предлагаем Вам помощь Конструкторского отдела:

- Подбор оптимального решения, техническое обоснование при выборе компонента;
- Подбор аналогов;
- Консультации по применению компонента;
- Поставка образцов и прототипов;
- Техническая поддержка проекта;
- Защита от снятия компонента с производства.



#### Как с нами связаться

**Телефон:** 8 (812) 309 58 32 (многоканальный)

**Факс:** 8 (812) 320-02-42

**Электронная почта:** [org@eplast1.ru](mailto:org@eplast1.ru)

**Адрес:** 198099, г. Санкт-Петербург, ул. Калинина, дом 2, корпус 4, литера А.