

Cree® XLamp® XP-C LEDs



PRODUCT DESCRIPTION

The XLamp XP-C LED combines the proven lighting-class performance and reliability of the XLamp XR-E LED in a package with 80% smaller footprint. The XLamp XP-C LED continues Cree’s history of innovation in LEDs for lighting applications with wide viewing angle, symmetrical package, unlimited floor life and electrically neutral thermal path.

Cree XLamp LEDs bring high performance and quality of light to a wide range of lighting applications, including color-changing lighting, portable and personal lighting, outdoor lighting, indoor directional lighting, commercial lighting and emergency-vehicle lighting.

FEATURES

- Available in white (2600 K to 10,000 K CCT), royal blue, blue, green, red, amber, red-orange
- Maximum drive current: up to 500 mA
- Low thermal resistance: as low as 10 °C/W
- Wide viewing angle: 110° – 125°
- Unlimited floor life at ≤ 30 °C/85% RH
- Reflow solderable - JEDEC J-STD-020C compatible
- Electrically neutral thermal path
- RoHS- and REACh-compliant
- UL-recognized component (E349212)

TABLE OF CONTENTS

| | |
|--|----|
| Flux Characteristics..... | 2 |
| Flux Characteristics - Color | 2 |
| Characteristics | 4 |
| Relative Spectral Power Distribution..... | 5 |
| Relative Flux vs. Junction Temperature | 6 |
| Electrical Characteristics..... | 7 |
| Thermal Design | 8 |
| Relative Flux vs. Current | 10 |
| Typical Spatial Distribution..... | 11 |
| Reflow Soldering Characteristics . | 12 |
| Notes..... | 13 |
| Mechanical Dimensions..... | 14 |
| Tape and Reel | 15 |
| Packaging..... | 16 |



FLUX CHARACTERISTICS (T_j = 25 °C)

The following table provides several base order codes for XLamp XP-C LEDs. It is important to note that the base order codes listed here are a subset of the total available order codes for the product family. For more order codes, as well as a complete description of the order-code nomenclature, please consult the XP Family Binning and Labeling document.

| Color | CCT Range | | Base Order Codes Min Luminous Flux @ 350 mA | | Order Code |
|---------------|-----------|----------|---|-----------|----------------------|
| | Min. | Max. | Group | Flux (lm) | |
| Cool White | 5000 K | 10,000 K | Q2 | 87.4 | XPCWHT-L1-0000-00A01 |
| | | | Q3 | 93.9 | XPCWHT-L1-0000-00B01 |
| | | | Q4 | 100 | XPCWHT-L1-0000-00C01 |
| Neutral White | 3700 K | 5300 K | P3 | 73.9 | XPCWHT-L1-0000-008E4 |
| | | | P4 | 80.6 | XPCWHT-L1-0000-009E4 |
| | | | Q2 | 87.4 | XPCWHT-L1-0000-00AE4 |
| Warm White | 2600 K | 3700 K | N4 | 62.0 | XPCWHT-L1-0000-006E7 |
| | | | P2 | 67.2 | XPCWHT-L1-0000-007E7 |
| | | | P3 | 73.9 | XPCWHT-L1-0000-008E7 |

Notes:

- Cree maintains a tolerance of ±7% on flux and power measurements, ±0.005 on chromaticity (CCx, CCy) measurements and ±2 on CRI measurements.
- Typical CRI for Cool White (5000 K – 10,000 K CCT) is 70.
- Typical CRI for Neutral White (3700 K – 5300 K CCT) is 75.
- Typical CRI for Warm White (2600 K – 3700 K CCT) is 80.

FLUX CHARACTERISTICS (T_j = 25 °C) - COLOR

The following table provides several base order codes for XLamp XP-C LEDs. It is important to note that the base order codes listed here are a subset of the total available order codes for the product family. For more order codes, as well as a complete description of the order-code nomenclature, please consult the XLamp XP Family Binning and Labeling document.

| Color | Dominant Wavelength Range | | | | Base Order Codes Min. Radiant Flux @ 350 mA | | Calculated Min. Radiant Flux (mW) @ 125 mA* | Order Code |
|------------|---------------------------|----------|-------|----------|---|-----------|---|----------------------|
| | Min. | | Max. | | Group | Flux (mW) | | |
| | Group | DWL (nm) | Group | DWL (nm) | | | | |
| Royal Blue | D3 | 450 | D5 | 465 | 12 | 250 | 104 | XPCROY-L1-0000-00701 |
| | | | | | 13 | 300 | 124 | XPCROY-L1-0000-00801 |
| | | | | | 14 | 350 | 145 | XPCROY-L1-0000-00901 |

* Calculated values for reference only

| Color | Dominant Wavelength Range | | | | Base Order Codes Min. Luminous Flux @ 350 mA | | Calculated Min. Luminous Flux (lm) @ 125 mA* | Order Code |
|-------|---------------------------|----------|-------|----------|--|-----------|--|----------------------|
| | Min. | | Max. | | Group | Flux (lm) | | |
| | Group | DWL (nm) | Group | DWL (nm) | | | | |
| Blue | B3 | 465 | B6 | 485 | J | 23.5 | 10.8 | XPCBLU-L1-0000-00W01 |
| | | | | | K2 | 30.6 | 13.8 | XPCBLU-L1-0000-00Y01 |

| Color | Dominant Wavelength Range | | | | Base Order Codes Min. Luminous Flux @ 350 mA | | Calculated Min. Luminous Flux (lm) @ 125 mA* | Order Code |
|-------|---------------------------|----------|-------|----------|--|-----------|--|----------------------|
| | Min. | | Max. | | Group | Flux (lm) | | |
| | Group | DWL (nm) | Group | DWL (nm) | | | | |
| Green | G2 | 520 | G4 | 535 | N3 | 56.8 | 28.2 | XPCGRN-L1-0000-00501 |
| | | | | | N4 | 62 | 30.8 | XPCGRN-L1-0000-00601 |
| | | | | | P2 | 67.2 | 33.3 | XPCGRN-L1-0000-00701 |
| | | | | | P3 | 73.9 | 36.7 | XPCGRN-L1-0000-00801 |

| Color | Dominant Wavelength Range | | | | Base Order Codes Min. Luminous Flux @ 350 mA | | Calculated Min. Luminous Flux (lm) @ 125mA* | Order Code |
|-------|---------------------------|----------|-------|----------|--|-----------|---|----------------------|
| | Min. | | Max. | | Group | Flux (lm) | | |
| | Group | DWL (nm) | Group | DWL (nm) | | | | |
| Amber | A2 | 585 | A3 | 595 | M2 | 39.8 | 14.9 | XPCAMB-L1-0000-00201 |
| | | | | | M3 | 45.7 | 17.1 | XPCAMB-L1-0000-00301 |
| | | | | | N2 | 51.7 | 19.4 | XPCAMB-L1-0000-00401 |
| | | | | | N3 | 56.8 | 21.3 | XPCAMB-L1-0000-00501 |

| Color | Dominant Wavelength Range | | | | Base Order Codes Min. Luminous Flux @ 350 mA | | Calculated Min. Luminous Flux (lm) @ 125 mA* | Order Code |
|------------|---------------------------|----------|-------|----------|--|-----------|--|----------------------|
| | Min. | | Max. | | Group | Flux (lm) | | |
| | Group | DWL (nm) | Group | DWL (nm) | | | | |
| Red-Orange | O3 | 610 | O4 | 620 | N2 | 51.7 | 19.8 | XPCRDO-L1-0000-00401 |
| | | | | | N3 | 56.8 | 21.7 | XPCRDO-L1-0000-00501 |
| | | | | | N4 | 62 | 23.7 | XPCRDO-L1-0000-00601 |
| | | | | | P2 | 67.2 | 25.7 | XPCRDO-L1-0000-00701 |

* Calculated values for reference only

| Color | Dominant Wavelength Range | | | | Base Order Codes Min. Luminous Flux @ 350 mA | | Calculated Min. Luminous Flux (lm) @ 125 mA* | Order Code |
|-------|---------------------------|----------|-------|----------|--|-----------|--|----------------------|
| | Min. | | Max. | | Group | Flux (lm) | | |
| | Group | DWL (nm) | Group | DWL (nm) | | | | |
| Red | R2 | 620 | R3 | 630 | M2 | 39.8 | 15.2 | XPCRED-L1-0000-00201 |
| | | | | | M3 | 45.7 | 17.5 | XPCRED-L1-0000-00301 |
| | | | | | N2 | 51.7 | 19.7 | XPCRED-L1-0000-00401 |
| | | | | | N3 | 56.8 | 21.7 | XPCRED-L1-0000-00501 |

* Calculated values for reference only

Note: Cree maintains a tolerance of +/- 7% on flux and power measurements.

CHARACTERISTICS

| Characteristics | Unit | Minimum | Typical | Maximum |
|--|---------|---------|---------|---------|
| Thermal Resistance, junction to solder point - white, royal blue, blue | °C/W | | 12 | |
| Thermal Resistance, junction to solder point - green | °C/W | | 20 | |
| Thermal Resistance, junction to solder point - amber | °C/W | | 15 | |
| Thermal Resistance, junction to solder point - red, red-orange | °C/W | | 10 | |
| Viewing Angle (FWHM) - white | degrees | | 115 | |
| Viewing Angle (FWHM) - royal blue, blue, green, red, red-orange, amber | degrees | | 125 | |
| Temperature coefficient of voltage - white, blue, royal blue, green | mV/°C | | -4.0 | |
| Temperature coefficient of voltage - red-orange, red, amber | mV/°C | | -2.0 | |
| ESD Classification (HBM per Mil-Std-883D) | | | Class 2 | |
| DC Forward Current - white, royal blue, blue, green | mA | | | 500 |
| DC Forward Current - red-orange, red, amber | mA | | | 350 |
| Reverse Voltage | V | | | 5 |
| Forward Voltage (@ 350 mA) - white | V | | 3.2 | 3.9 |
| Forward Voltage (@ 350 mA) - royal blue, blue | V | | 3.3 | 3.9 |
| Forward voltage (@ 350 mA) - green | V | | 3.4 | 3.9 |
| Forward voltage (@ 350 mA) - red-orange, red, amber | V | | 2.2 | 2.5 |
| Forward Voltage (@ 125 mA) - royal blue, blue | V | | 3.1 | |
| Forward Voltage (@ 125 mA) - green | V | | 3.3 | |
| Forward Voltage (@ 125 mA) - red-orange, red | V | | 2.0 | |
| Forward Voltage (@ 125 mA) - amber | V | | 2.1 | |
| Forward voltage (@ 500 mA) - royal blue, blue, white | V | | 3.5 | |
| Forward Voltage (@ 500 mA) - green | V | | 3.6 | |
| LED Junction Temperature | °C | | | 150 |

RELATIVE SPECTRAL POWER DISTRIBUTION

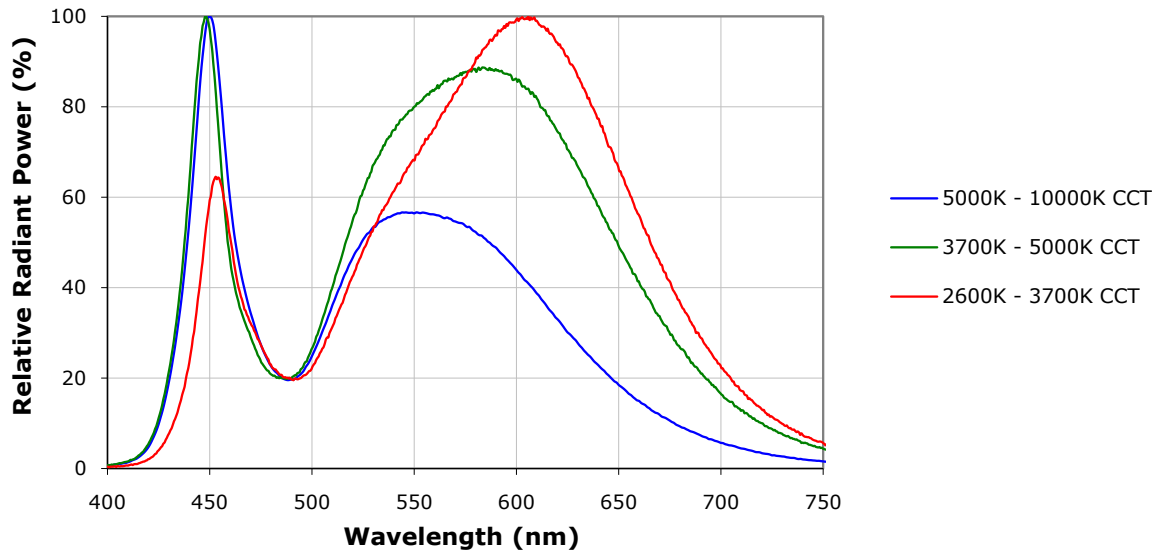

White

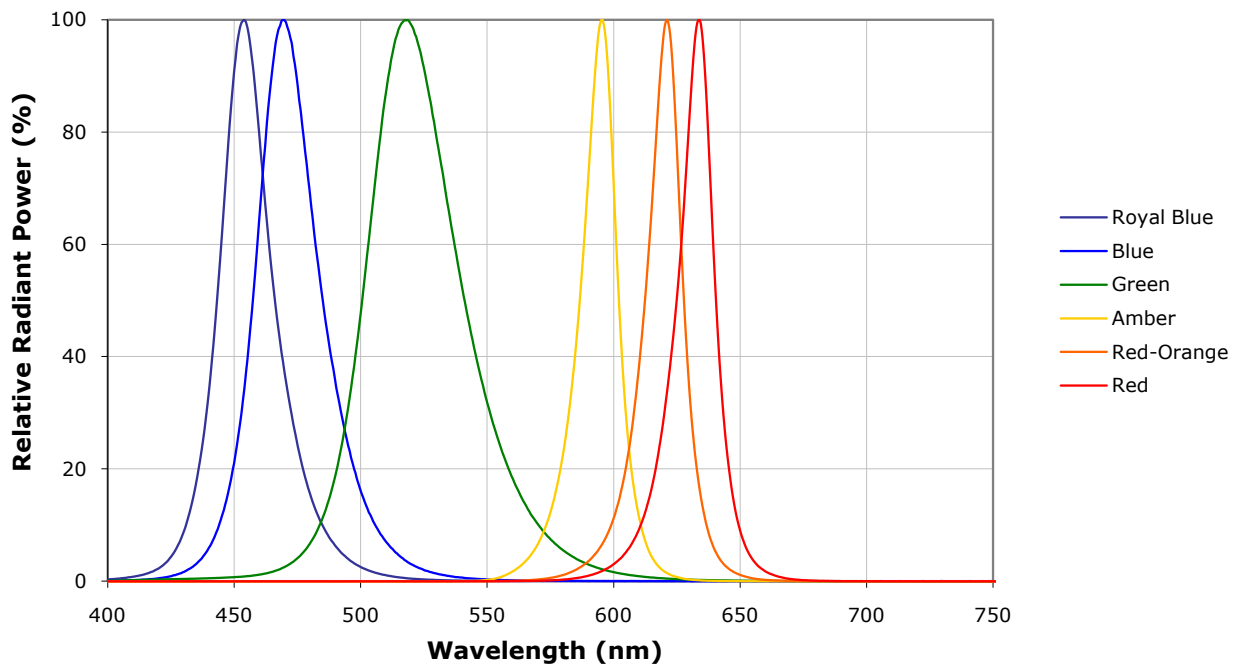

Color

RELATIVE FLUX VS. JUNCTION TEMPERATURE ($I_F = 350 \text{ mA}$)



ELECTRICAL CHARACTERISTICS ($T_j = 25\text{ }^\circ\text{C}$)

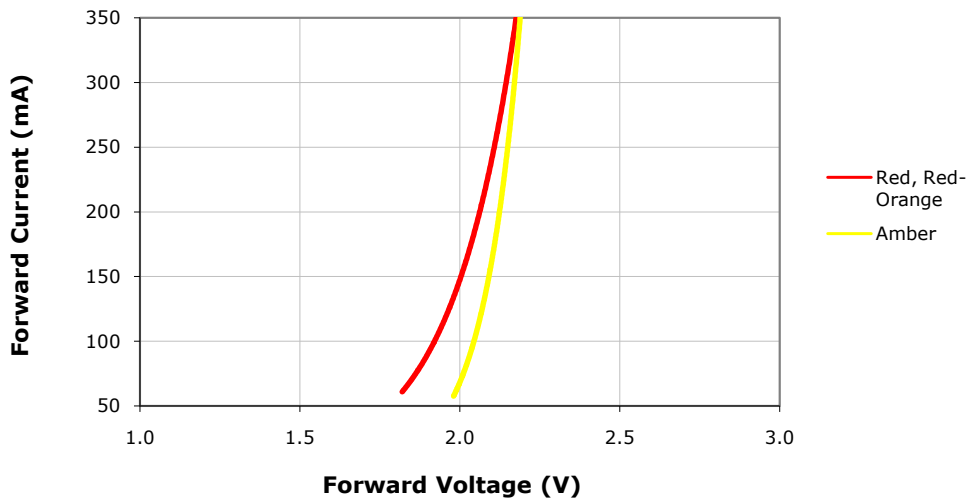

THERMAL DESIGN

The maximum forward current is determined by the thermal resistance between the LED junction and ambient. It is crucial for the end product to be designed in a manner that minimizes the thermal resistance from the solder point to ambient in order to optimize lamp life and optical characteristics.

White, Blue,
Royal Blue

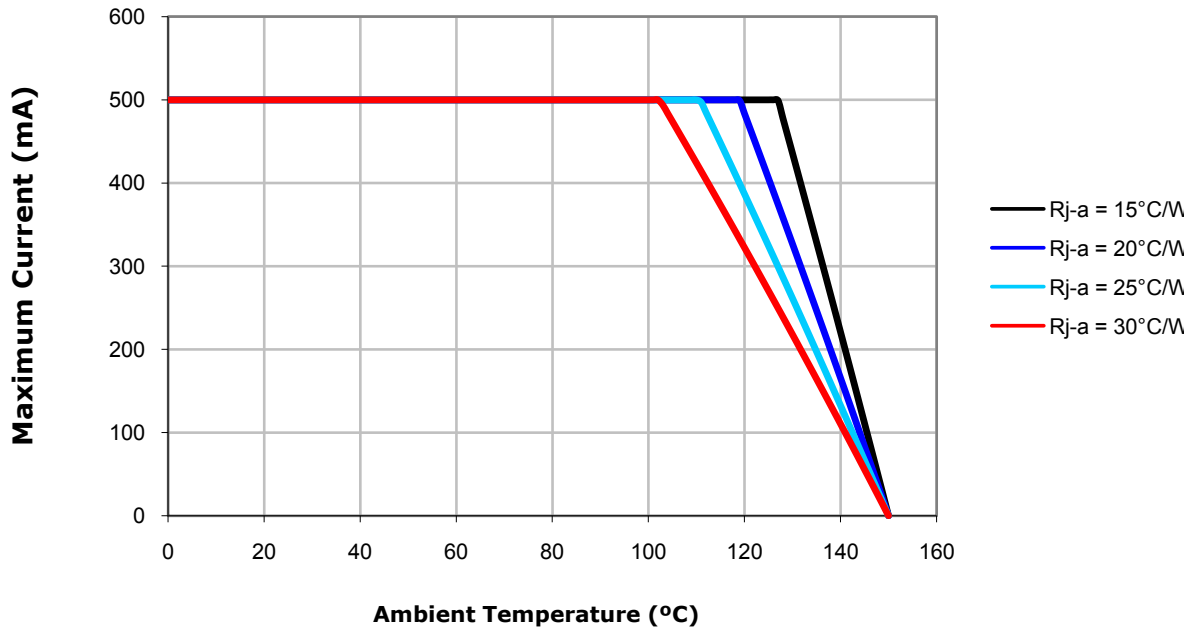

Green

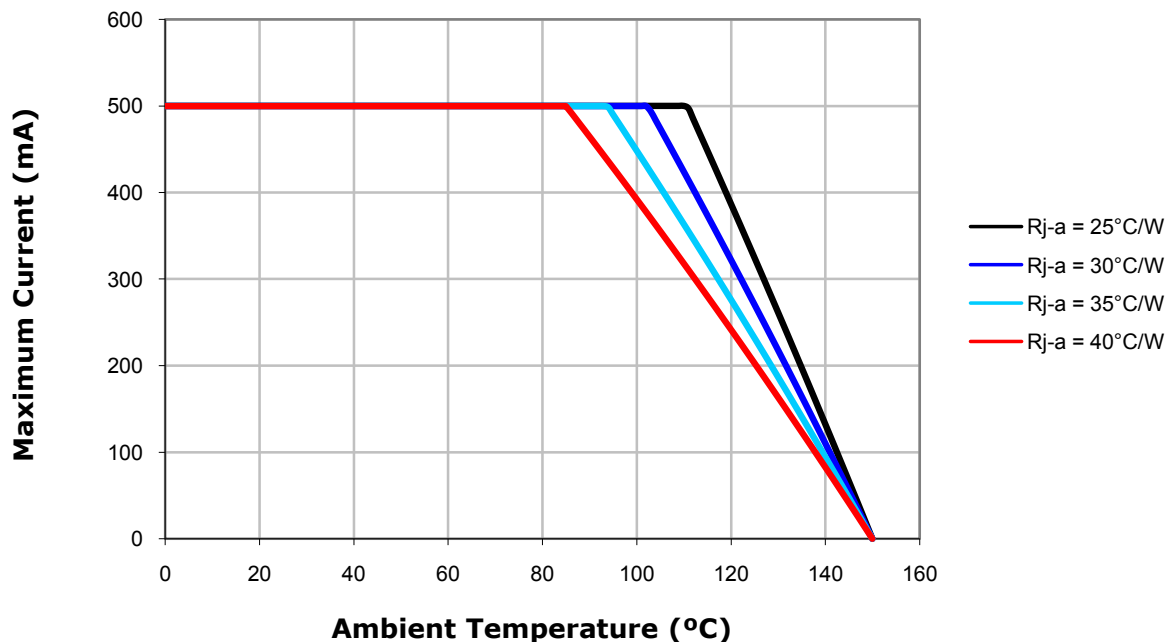

THERMAL DESIGN (CONTINUED)

Amber



Red,
Red-Orange



RELATIVE FLUX VS. CURRENT ($T_j = 25\text{ }^\circ\text{C}$)



TYPICAL SPATIAL DISTRIBUTION



REFLOW SOLDERING CHARACTERISTICS

In testing, Cree has found XLamp XP-C LEDs to be compatible with JEDEC J-STD-020C, using the parameters listed below. As a general guideline, Cree recommends that users follow the recommended soldering profile provided by the manufacturer of solder paste used.

Note that this general guideline may not apply to all PCB designs and configurations of reflow soldering equipment.



| Profile Feature | Lead-Based Solder | Lead-Free Solder |
|---|-------------------|------------------|
| Average Ramp-Up Rate ($T_{s_{max}}$ to T_p) | 3 °C/second max. | 3 °C/second max. |
| Preheat: Temperature Min ($T_{s_{min}}$) | 100 °C | 150 °C |
| Preheat: Temperature Max ($T_{s_{max}}$) | 150 °C | 200 °C |
| Preheat: Time ($t_{s_{min}}$ to $t_{s_{max}}$) | 60-120 seconds | 60-180 seconds |
| Time Maintained Above: Temperature (T_l) | 183 °C | 217 °C |
| Time Maintained Above: Time (t_l) | 60-150 seconds | 60-150 seconds |
| Peak/Classification Temperature (T_p) | 215 °C | 260 °C |
| Time Within 5 °C of Actual Peak Temperature (t_p) | 10-30 seconds | 20-40 seconds |
| Ramp-Down Rate | 6 °C/second max. | 6 °C/second max. |
| Time 25 °C to Peak Temperature | 6 minutes max. | 8 minutes max. |

Note: All temperatures refer to topside of the package, measured on the package body surface.

NOTES

Moisture Sensitivity

In testing, Cree has found XLamp XP-C & XP-E LEDs to have unlimited floor life in conditions ≤ 30 °C/85% relative humidity (RH). Moisture testing included a 168-hour soak at 85 °C/85% RH followed by 3 reflow cycles, with visual and electrical inspections at each stage.

Cree recommends keeping XLamp LEDs in their sealed moisture-barrier packaging until immediately prior to use. Cree also recommends returning any unused LEDs to the resealable moisture-barrier bag and closing the bag immediately after use.

RoHS Compliance

The levels of RoHS restricted materials in this product are below the maximum concentration values (also referred to as the threshold limits) permitted for such substances, or are used in an exempted application, in accordance with EU Directive 2011/65/EC (RoHS2), as amended through June 8, 2011. RoHS Declarations for this product can be obtained from your Cree representative or obtained from the Product Ecology section of www.cree.com.

REACH Compliance

REACH substances of high concern (SVHCs) information is available for this product. Since the European Chemical Agency (ECHA) has published notices of their intent to frequently revise the SVHC listing for the foreseeable future, please contact a Cree representative to insure you get the most up-to-date REACH Declaration. Historical REACH banned substance information (substances restricted or banned in the EU prior to 2010) is also available upon request.

UL Recognized Component

Level 4 enclosure consideration. The LED package or a portion thereof has been investigated as a fire and electrical enclosure per ANSI/UL 8750.

Vision Advisory Claim

WARNING: Do not look at exposed lamp in operation. Eye injury can result. See LED Eye Safety at www.cree.com/xlamp_app_notes/led_eye_safety.

Intellectual Property

For remote phosphor applications, a separate license to certain Cree patents is required.

MECHANICAL DIMENSIONS (T_A = 25°C)

All measurements are ±.13 mm unless otherwise indicated.



Top View



Side View

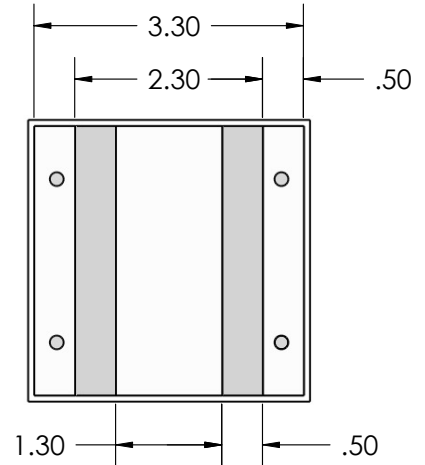

Bottom View



RECOMMENDED PCB SOLDER PAD



**RECOMMENDED STENCIL PATTERN
(HATCHED AREA IS OPENING)**

PACKAGING

Unpackaged Reel



Label with Cree Bin Code, Qty, Reel ID

Packaged Reel



Label with Cree Order Code, Qty, Reel ID, PO #

Label with Cree Bin Code, Qty, Reel ID

Boxed Reel

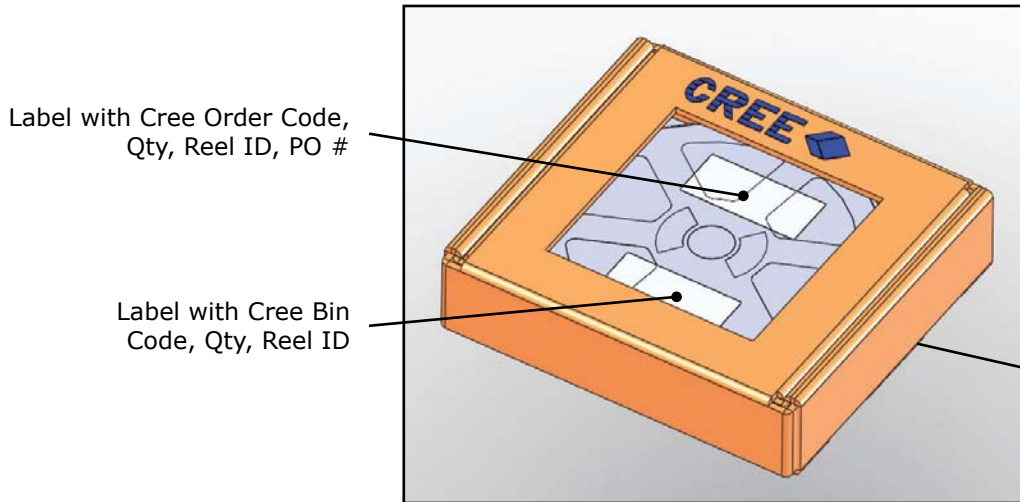

Label with Cree Order Code, Qty, Reel ID, PO #

Label with Cree Bin Code, Qty, Reel ID

Patent Label (on bottom of box)



Компания «ЭлектроПласт» предлагает заключение долгосрочных отношений при поставках импортных электронных компонентов на взаимовыгодных условиях!

Наши преимущества:

- Оперативные поставки широкого спектра электронных компонентов отечественного и импортного производства напрямую от производителей и с крупнейших мировых складов;
- Поставка более 17-ти миллионов наименований электронных компонентов;
- Поставка сложных, дефицитных, либо снятых с производства позиций;
- Оперативные сроки поставки под заказ (от 5 рабочих дней);
- Экспресс доставка в любую точку России;
- Техническая поддержка проекта, помощь в подборе аналогов, поставка прототипов;
- Система менеджмента качества сертифицирована по Международному стандарту ISO 9001;
- Лицензия ФСБ на осуществление работ с использованием сведений, составляющих государственную тайну;
- Поставка специализированных компонентов (Xilinx, Altera, Analog Devices, Intersil, Interpoint, Microsemi, Aeroflex, Peregrine, Syfer, Eurofarad, Texas Instrument, Miteq, Cobham, E2V, MA-COM, Hittite, Mini-Circuits, General Dynamics и др.);

Помимо этого, одним из направлений компании «ЭлектроПласт» является направление «Источники питания». Мы предлагаем Вам помощь Конструкторского отдела:

- Подбор оптимального решения, техническое обоснование при выборе компонента;
- Подбор аналогов;
- Консультации по применению компонента;
- Поставка образцов и прототипов;
- Техническая поддержка проекта;
- Защита от снятия компонента с производства.



Как с нами связаться

Телефон: 8 (812) 309 58 32 (многоканальный)

Факс: 8 (812) 320-02-42

Электронная почта: org@eplast1.ru

Адрес: 198099, г. Санкт-Петербург, ул. Калинина, дом 2, корпус 4, литера А.