

# Amphenol

Vehicle Interconnect System

整车连接系统

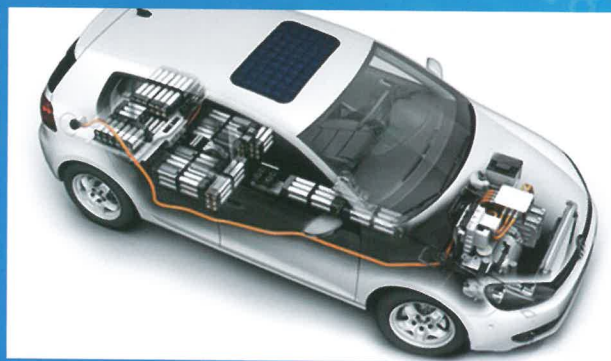

RADLOK PowerLok PowerLink PowerBus PowerLug  
RADLOK PowerLok PowerLink PowerBus PowerLug  
RADLOK PowerLok PowerLink PowerBus PowerLug

Amphenol



Amphenol Technical Products International Co.

## 公司简介 About Amphenol-TPI

Amphenol创立于1932年，为全球最大连接器制造商之一。

Amphenol主要为各行业提供连接解决方案并提供互连产品。包括：航空及军用连接器解决方案、汽车工业连接解决方案、铁路工业连接解决方案、无线通讯连接解决方案、互联网连接器解决方案、宽带通讯连接解决方案、通用工业连接解决方案等。Amphenol具有全面的产品线，成千上万种连接器产品应用于通信及信息处理领域；航空领域、军用领域、汽车领域、铁路领域及其它交通和通用工业领域等。Amphenol在全球实施本地化战略，共在全球设立了80多间工厂及100多个销售办事处，直接为各大洲的客户的产品和实施本地化服务。

ATPI 是安费诺集团位于加拿大温尼伯的全资子公司，ATPI广州是ATPI设在中国的分支机构。

Amphenol was founded in 1932, is one of the world's largest connector manufacturer.

Amphenol is mainly for various industries to provide connection solutions and provide interconnect products. Include: aviation and military connector solutions, the automotive industry solutions, railway industrial link solution, wireless communication solutions, Internet connector solution, broadband communications link solution, general industrial solutions such as Amphenol has a comprehensive product line, tens of thousands of kinds of connector products applied in the field of communications and information processing; Aviation, military areas, automobile industry, railway and other transportation and general industrial sectors and so on. Amphenol implement localization strategy in the whole world, set up more than 80 factories in the world and more than 100 sales offices, directly to the continents of customers with products and the implementation of the localization service

ATPI – Amphenol Technical Products International Co. is a subsidiary of amphenol group based in Canada. ATPI-G – Amphenol Technical Products International (Guangzhou) Co. is a branch of ATPI based in China.

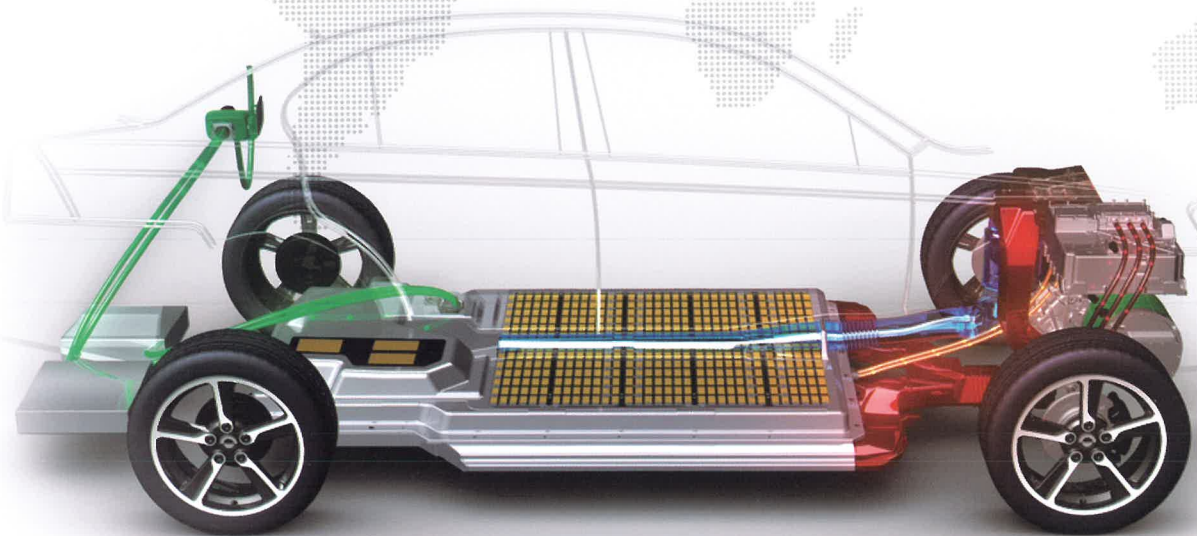



整车应用  
Vehicle Application

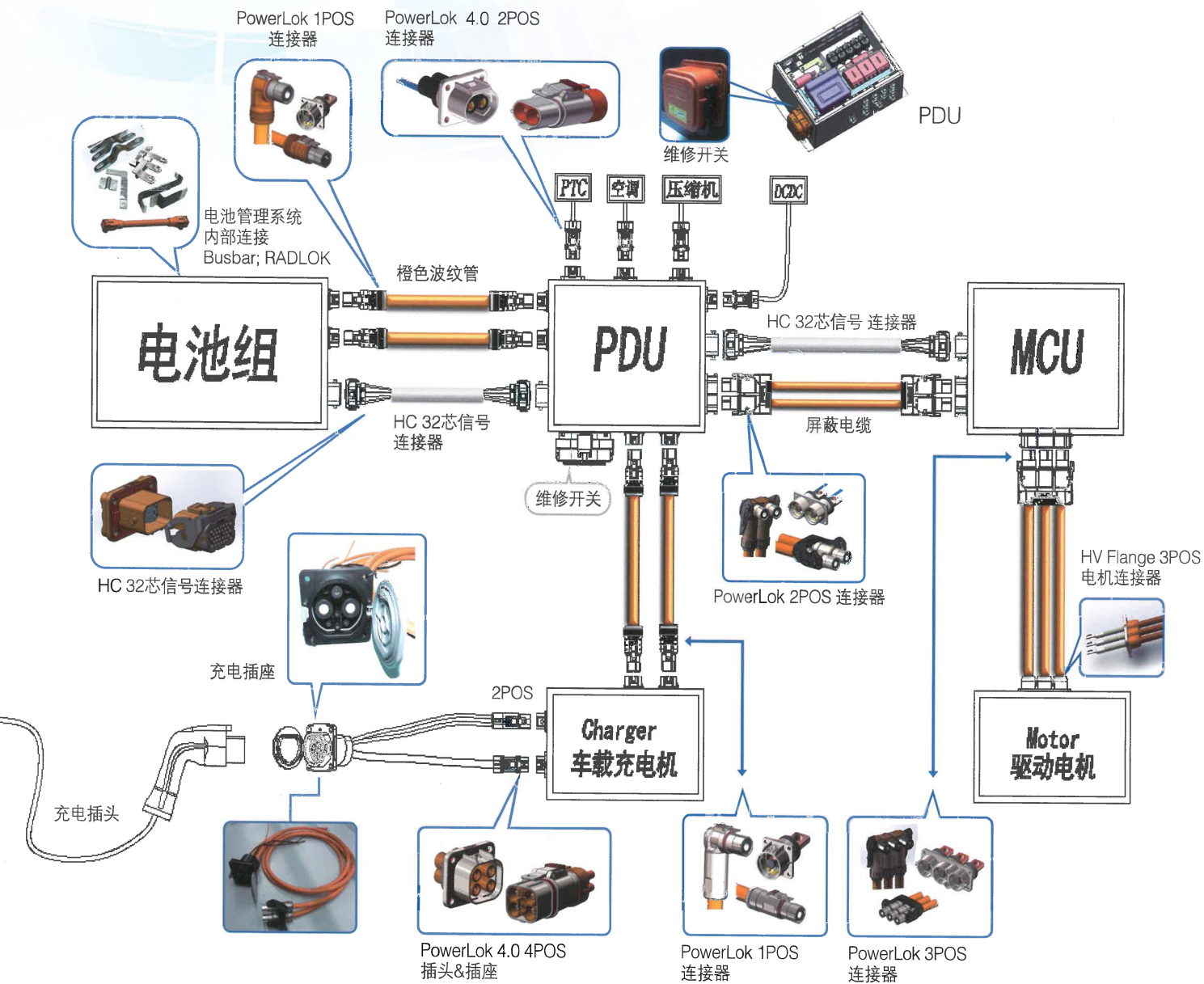

### PowerLok™ 连接器 PowerLok™ Connector

安费诺PowerLok™产品运用了最新安费诺RADSOK®技术，是对于混合动力汽车和纯电动汽车行业里，需要可靠的、可定制的、易于安装的、节约成本的连接器现状的最佳解决方案。PowerLok™产品具备了防水屏蔽，二级锁扣，高压互锁，多种极性等特点。

Utilizing Amphenol latest RADSOK® technology, Amphenol PowerLok™ product is the answer to HEV/EV where a custom, reliable, easy to install, and cost effective solution is required. PowerLok™ has many features: fully shielding, Automatic Secondary Lock, HVIL optional, Multi Polarization.

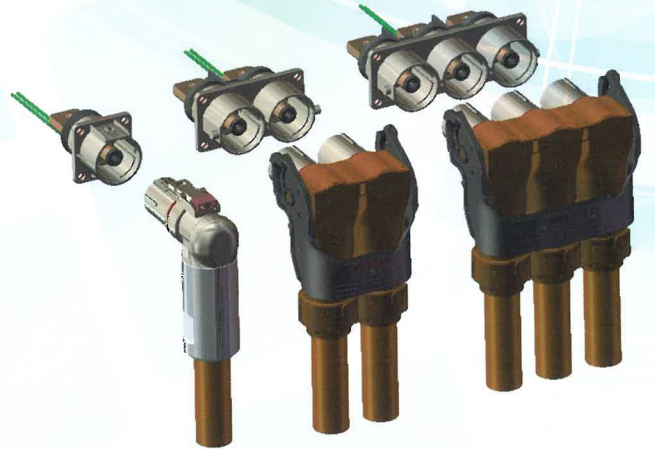

### PowerLok™ 4.0 连接器 PowerLok™ 4.0 Connector

安费诺PowerLok™ 4.0 连接器是针对电动汽车中小电流应用推出的一款方案。在附带PowerLok™ 产品全部优势的同时，该产品的2芯或4芯紧密型设计能更好适应狭小空间的应用。

Amphenol PowerLok™ 4.0 Connector is designed for EV' s medium and small current application. In the supplementary PowerLok™ product all advantages at the same time, the 2 & 4 position small size design can be adapt to the application in narrow space better.

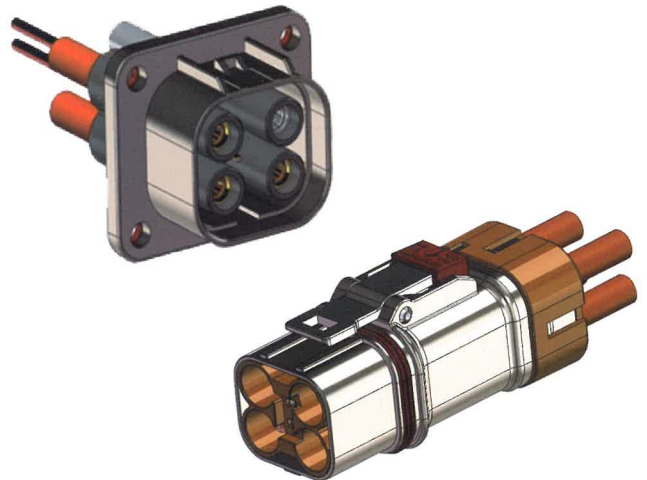

### PowerLok™ 塑料连接器 PowerLok™ Plastic Connector

安费诺PowerLok™ 塑料连接器是PowerLok™ 产品中低成本方案。该产品的特色在于360度可旋转设计和塑料低成本设计。

Amphenol PowerLok™ plastic connector is PowerLok™ products of low cost solutions. The characteristics of this product is 360 degree rotating design and plastic low cost design.



## POWERLINK™ 电缆 POWERLINK™ Cable

安费诺POWERLINK™高压电缆可用于有高温/防油/阻燃要求的环境。该线缆具备高电压、柔韧、电磁屏蔽等特点，应用在电动汽车、混合动力汽车、燃料电池汽车、电池储能等领域。

Amphenol POWERLINK™ HV Cable are used in high temperature / oil / flame-resistance requirements condition. High voltage, flexible, electromagnetically shielded automotive cable for applications on EV, HEV, FCEV, Battery and Energy Storage wiring systems.



## HV Flange™ HV Flange Connector

安费诺HV Flange™ 连接器是针对无插拔要求的应用而设计的低成本方案。该产品的特点在于移除了插头和插座，二级锁扣及高压互锁设计，降低了产品的成本。

Amphenol HV Flange™ connector is designed for some Non-pluggable requirement application. The characteristics of this product is we removed the plug and receptacle, automatic secondary lock and HVIL design, then reduced the cost.

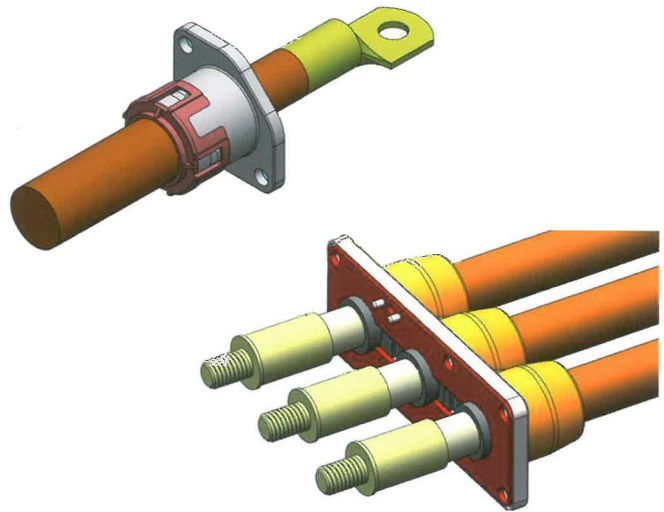

## 电源分配单元 Power Distribution Unit

高压电气控制单元。它包括盒体和盒盖,盒体内设有电机电源控制系统、空调电源控制系统、充电机电源控制系统、电池包控制系统和直流转化装置电源控制系统。

High voltage electrical control unit. It comprises a box body and a box cover, the box body is provided with a motor power supply control system, air conditioning control system for power supply, battery pack charger power control system, control system and DC power conversion device control system.

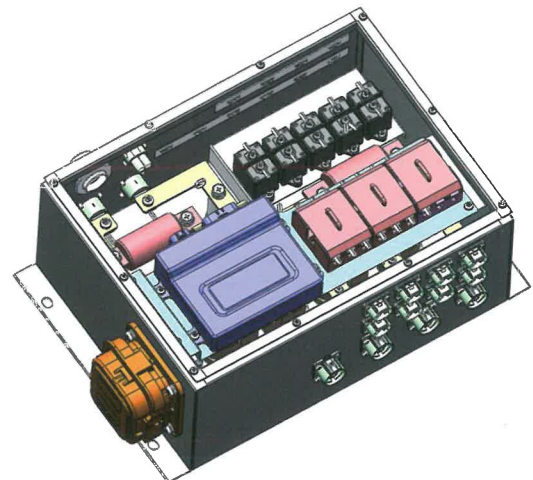



**产品特点**  
Product Features

- 高压互锁 / HVIL
- IP67及屏蔽 / IP67 & Shielding
- 二次锁口 / Automatic Secondary Lock
- 1-3芯可选 / 1-3Positions Available
- 90度及180度插头 / 90 D and 180 D plug
- 5种键位 / 5Keys

**应用领域**  
Applications

- 新能源电动汽车  
New Energy Electric Vehicles
- 变频器 / Frequency Converter
- 逆变器 / Inverter
- 电池连接 / Battery Connection



**技术参数**  
Technical Data

DC Current Rating	90-500A
DC Voltage Rating	1000V
Temperature Range	-40° C to +125° C
Flammability	UL94 V-0
Mating Cycle	Min. 50
Mutil Polarization	5 Keys

PowerLok Recommended Cable Size & Current Rating

Current Rating of Connector(A)	Accepted Cbl Size(mm) <sup>2</sup>	Current Rating of Cable(A)
120 Series	16	90
	25	120
200 Series	35	150
	50	200
300 Series	35	150
	50	200
	70	250
400 Series	95	300
	120	350
	135	400
500 Series	120	350
	135	400
	150	500

PowerLok 连接器插头 / PowerLok Connector Plug

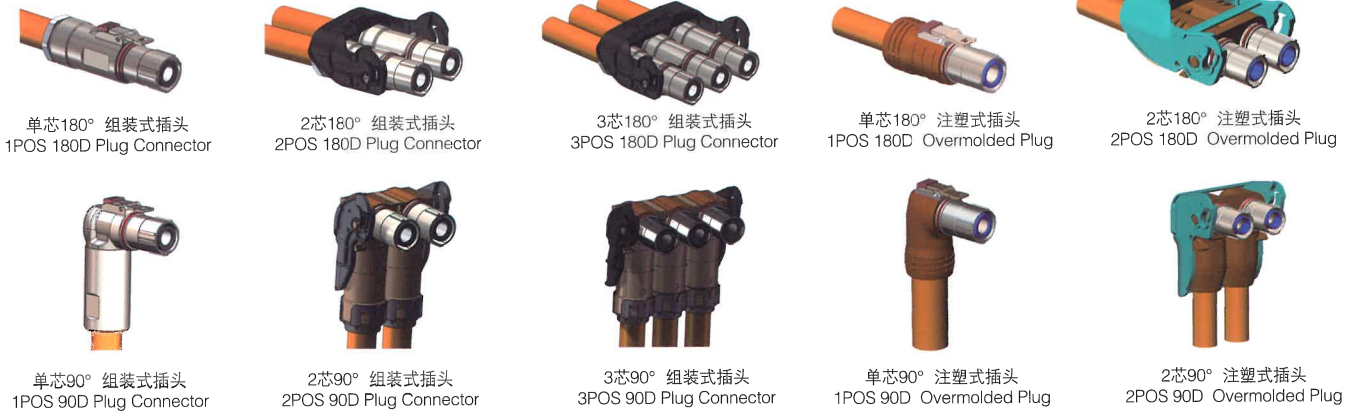

PowerLok插头选型信息

PowerLok Plug Ordering Information

选型例子

Order Example

PL 10 X - 301 - 70

Product Type	(A) Plug Type	(B) Polarization	(C) Series	(D) Cable Size(mm <sup>2</sup> )
PL PowerLok™	10 Overmolded Cble Assembly, Straight	X 1POS,Key "X" Orange	120 120 Series	Refer to "PowerLok™ Recommended Cable Size & Current Rating"
	20 Overmolded Cble Assembly, Right Angle	Y 1POS,Key "Y" Black	121 120 Series with HVIL	
	18 Plug Connector, Straight	U 1POS,Key "U" Yellow	200 200 Series	
	28 Plug Connector,Right Angle	V 1POS,Key "V" Green	201 201 Series with HVIL	
		W 1POS,Key "W" Red	300 300 Series	
		2X 2POS,Key "X"	301 300 Series with HVIL	
		2Y 2POS,Key "Y"	400 400 Series	
		3X 3POS,Key "X"	401 401 Series with HVIL	
		3Y 3POS,Key "Y"	500 500 Series	
			501 500 Series with HVIL	

**PowerLok 连接器插座**  
PowerLok Connector Receptacle



单芯插座  
1POS Receptacle



2芯插座  
2POS Receptacle



3芯插座  
3POS Receptacle

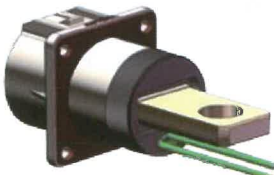

终端形式：铜排  
Termination Type: Lug



终端形式：螺栓  
Termination Type: Thread Bolt



终端形式：铜管  
Termination Type: Crimping Lug



终端形式：90D铜排  
Termination Type: 90D Lug

PowerLok连接器插座选型信息  
PowerLok Receptacle Ordering Information

选型例子  
Order Example

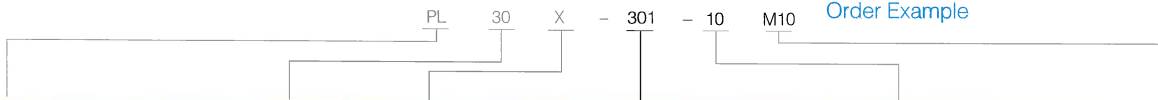

Product Type	(A) Connector Type	(B) Polarization & (Touch Proof Cover) color	(C) Series	(D) Termination Type	(E) Termination Size				
PL PowerLok™	00	1 POS Receptacle	X Key "X", Orange	120	120 Series	10	Lug	M+Stud Size	Screw Hole
	08	2 POS & 3 POS Receptacle	Y Key "Y", Black	121	120 Series with HVIL	20	Thread Pin	D+Stud Size	Through Hole
			U Key "U", Yellow	200	200 Series	30	Crimping Lug	M+Thread Size	Thread Size
			V Key "V", Green	201	201 Series with HVIL	90	90D Lug		
			W Key "W", Red	300	300 Series				
			2X 2POS,Key "X"	301	300 Series with HVIL				
			2Y 2POS,Key "Y"	400	400 Series				
			3X 3POS,Key "X"	401	401 Series with HVIL				
			3Y 3POS,Key "Y"	500	500 Series				
			501	500 Series with HVIL					

**产品特点**  
Product Features

- 高压互锁/HVIL
- IP67及屏蔽/IP67 & Shielding
- 二次锁口/Automatic Secondary Lock
- 2&4芯可选/2&4Positions Available
- 90度及180度插头/90 D and 180 D plug

**应用领域**  
Applications

- 电池连接/Battery Connection
- 新能源电动汽车/New Energy Electric Vehicles
- 变频器/Frequency Converter
- 大型开关柜/Large Switchgear

**技术参数**  
Technical Data

DC Current Rating	20 A~60 A
DC Voltage Rating	1000V
Temperature Range	-40° C to +125° C
Flammability	UL94 V-0
Mating Cycle	Min. 50
Mutil Polarization	3 Keys

**PowerLok 4.0 二芯连接器**  
PowerLok 4.0 2POS Connector



2芯插座  
2POS Receptacle



2芯插头  
2POS Plug

PowerLok P4连接器选型信息  
PowerLok P4 Connector Ordering Information

选型例子  
Order Example

(A) Product Type		(B) Connector Type		(C) Polarization & color		(D) Series		(E) Accepted Cable Size		
								Cable Size	Current Rating	
PL	PowerLok™	082	2POS Receptacle	X	Key "X", Orange	60	60 Series	2.5	2.5mm <sup>2</sup>	25A
		182	2POS Plug, Straight	Y	Key "Y", Black	61	60 Series with HVIL	4	4mm <sup>2</sup>	40A
				U	Key "U", Yellow			6	6mm <sup>2</sup>	45A
								10	10mm <sup>2</sup>	60A



**PowerLok 4.0 四芯连接器**  
PowerLok 4.0 POS Connector



4芯插座  
4POS Receptacle

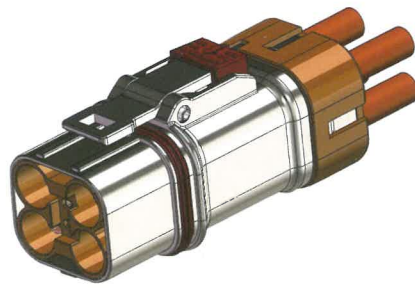

4芯插头  
4POS Plug

PowerLok P4 连接器选型信息  
PowerLok P4 Connector Ordering Information

选型例子  
Order Example

PL 182 X - 61 - 4

(A) Product Type		(B) Connector Type		(C) Polarization & color		(D) Series		(E) Accepted Cable Size		
								Cable Size	Current Rating	
PL	PowerLok™	024	4POS Receptacle	X	Key "X", Orange	40	40 Series	2.5	2.5mm <sup>2</sup>	25A
		184	4POS Plug, Straight	Y	Key "Y", Black	41	40 Series with HVIL	4	4mm <sup>2</sup>	40A
				U	Key "U", Yellow			6	6mm <sup>2</sup>	45A

**产品特点**  
Product Features

- 360° 旋转 / 360 degree rotatable
- 塑料低成本 / Plastic Low Cost
- IP67 保护 / IP67 Protection
- 二次锁扣 / Automatic Secondary Lock
- 90度及180度插头 / 90 D and 180 D plug

**应用领域**  
Applications

- 电池连接 / Battery Connection
- 新能源电动汽车 / New Energy Electric Vehicles
- 变频器 / Frequency Converter
- 大型开关柜 / Large Switchgear

PowerLok 塑料连接器插头  
PowerLok Plastic Connector Plug



塑料直角插头  
Plastic Plug, Right Angle

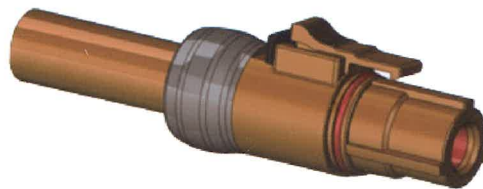

塑料直头插头  
Plastic Plug, Straight

PowerLok 塑料连接器选型信息  
PowerLok Plastic Connector Ordering Information

选型例子  
Order Example

Product Type	(A) Plug Type	(B) Polarization	(C) Series	(D) Cable Size(mm²)
PL PowerLok™	40 Overmolded Cble Assembly, Straight	X 1 POS ,Key "X" Orange	120 120 Series	Refer to "PowerLok™ Recommended Cable Size & Current Rating" Chart
	50 Overmolded Cble Assembly, Right Angle	Y 1 POS ,Key "Y" Black	200 200 Series	
		U 1 POS ,Key "U" Yellow	300 300 Series	
		V 1 POS ,Key "V" , Green		
		W 1 POS ,Key "W", Red		

**技术参数**  
Technical Data

DC Current Rating	90 A~300 A
DC Voltage Rating	1000V
Temperature Range	-40° C to +125° C
Flammability	UL94 V-0
Mating Cycle	Min. 50
Mutil Polarization	5 Keys

Recommended Cable Size & Current Rating

Current Rating of Connector(A)	Accepted Cbl Size (mm²)	Current Rating of Cable(A)
120 Series	16	90
	25	120
200 Series	35	150
	50	200
300 Series	35	150
	50	200
	70	250
	95	300

**PowerLok 塑料连接器插座**  
PowerLok Plastic Connector Receptacle

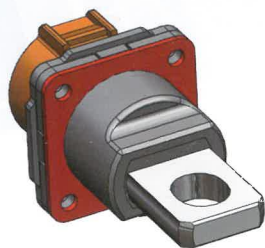

终端形式：铜排  
Termination Type: Busbar

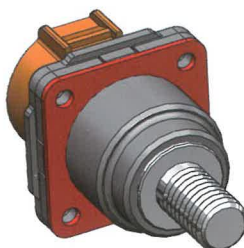

终端形式：螺柱  
Termination Type: Thread Bolt

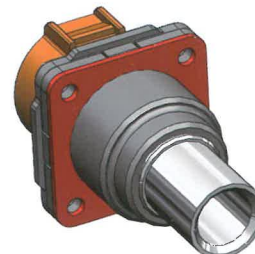

终端形式：铜管  
Termination Type: Tubular Lug

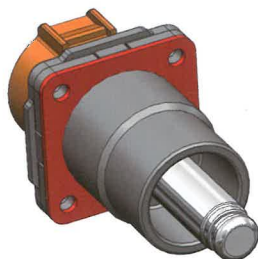

终端形式：RADLOK端子  
Termination Type: RADLOK Pin

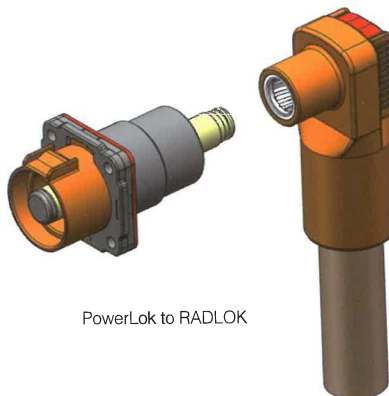

PowerLok to RADLOK

PowerLok 塑料连接器选型信息  
PowerLok Plastic Connector Ordering Information

选型例子  
Order Example

PL 30 X - 300 - 10 M10

Product Type	(A) Connector Type	(B) Polarization & (Touch Proof Cover) color	(C) Series	(D) Termination Type	(E) Termination Size				
PL PowerLok™	30	1 POS Receptacle	X Key "X", Orange	120	120 Series	10	Busbar	M+Stud Size	Screw Hole
			Y Key "Y", Black	200	200 Series	20	Thread Pin	D+Stud Size	Through Hole
			U Key "U", Yellow	300	300 Series	30	Lug	M+Thread Size	Thread Size
			V Key "V", Green			40	Pin	R+Pin Size	Pin Size
			W Key "W", Red						



产品名 Production Name

POWERLINK™ 高压屏蔽电缆/POWERLINK™ HV Shielding Cable

材料 Material

- 导体-裸铜 / Conductor - Bare Copper
- 绝缘-橘色XLPE / Insulation - XLPE Orange
- 屏蔽-铝箔麦拉 / Shielding - AL-MYLAR
- 外被-橘色XLPE / Jacket - XLPE Orange

RoHS和REACH法规符合/RoHS and REACH Compliant

标准Standard: ISO 6722 Class C 125

产品特点 Product Features

- 高压高电流可靠 / Reliable to high-voltage & current conditions
- 柔软易安装 / Flexible and easy to handle for harnessing
- 外径2.5 mm<sup>2</sup>至150 mm<sup>2</sup> / Range from 2.5 mm<sup>2</sup> to 150 mm<sup>2</sup>
- 电磁屏蔽 / Excellent EMI, EMC noise reduction

Amphenol Industrial POWERLINK HV Shielding Cable - 500V

POWERLINK™ 高压屏蔽电缆  
POWERLINK™ HV Shielding Cable

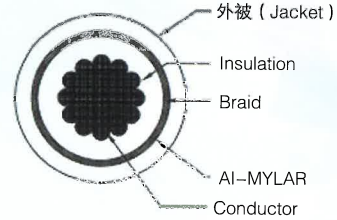

应用领域 Applications

- 电动汽车, 混合动力汽车, 燃料电池汽车  
EV, HEV, FCEV

结构尺寸/Construction & Dimensions

料号 P/N	导体截面积 Size	导体结构 Conductor Structure (mm)	平均绝缘厚度 Insulation Av. Thickness (mm)	最小绝缘厚度 Insulation Min. Thickness (mm)	芯线外径 Dia Primary Insulation (mm)	护套厚度 Sheath Thickness (mm)	线缆外径 Nom Dia Outside (mm)	弯曲半径 Bending Radius
AC-CP710020	2.5mm <sup>2</sup>	124/0.16	0.6	0.44	3.30± 0.2	0.6	5.2± 0.2	≥ 4 X OD
AC-CP710040	4mm <sup>2</sup>	199/0.16	0.6	0.44	4.10± 0.2	0.6	5.8± 0.2	≥ 4 X OD
AC-CP710060	6mm <sup>2</sup>	298/0.16	0.6	0.44	4.80± 0.2	0.6	6.7± 0.3	≥ 4 X OD
AC-CP710100	10mm <sup>2</sup>	497/0.16	0.8	0.62	6.25± 0.2	0.8	8.6± 0.3	≥ 4 X OD
AC-CP710160	16mm <sup>2</sup>	796/0.16	1.0	0.80	8.10± 0.2	1.3	11.2± 0.3	≥ 4 X OD
AC-CP710250	25mm <sup>2</sup>	1244/0.16	1.3	1.04	10.20± 0.2	1.3	13.5± 0.3	≥ 5 X OD
AC-CP710350	35mm <sup>2</sup>	1743/0.16	1.3	1.04	11.50± 0.3	1.3	14.5± 0.5	≥ 5 X OD
AC-CP710500	50mm <sup>2</sup>	2492/0.16	1.5	1.20	13.60± 0.3	1.4	17.0± 0.5	≥ 5 X OD
AC-CP710700	70mm <sup>2</sup>	3486/0.16	1.5	1.20	15.50± 0.3	1.5	19.5± 0.5	≥ 5 X OD
AC-CP710950	95mm <sup>2</sup>	4732/0.16	1.8	1.52	18.20± 0.5	1.5	22.6± 0.5	≥ 5 X OD
AC-CP711200	120mm <sup>2</sup>	5985/0.16	1.9	1.61	20.20± 0.5	1.5	24.6± 0.5	≥ 6 X OD
AC-CP711500	150mm <sup>2</sup>	7467/0.16	2.1	1.79	22.50± 0.5	1.6	27.1± 0.5	≥ 6 X OD

特征 / Characteristics

Item	Characteristics
Rating Voltage	1500V DC
Conductor Resistance(Max.)Ω /km@20°C	7.600Ω /km (2.5 mm <sup>2</sup> )
	4.710Ω /km (4 mm <sup>2</sup> )
	2.890Ω /km (6 mm <sup>2</sup> )
	1.820Ω /km (10 mm <sup>2</sup> )
	1.160Ω /km (16 mm <sup>2</sup> )
	0.743Ω /km (25 mm <sup>2</sup> )
Temperature Rating	-40°C to +125°C
Flame Test	VW-1
Withstand Voltage	6000V / 5min
Oil Resistant Acid and Alkali Resistant	

**产品名 Production Name**

POWERLINK™ 高压电缆/POWERLINK™ HV Cable

**材料  
Material**

- 导体- 裸铜/Conductor – Bare Copper
- 绝缘- 橘色XLPE/Insulation – XLPE Orange

RoHS和REACH法规符合/ RoHS and REACH Compliant

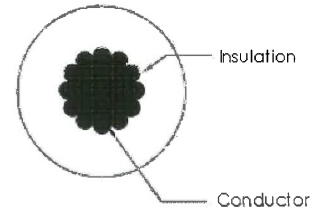
**标准Standard:** ISO 6722 Class C 125POWERLINK™ 高压电缆  
POWERLINK™ HV Cable

Insulation

Conductor

**产品特点  
Product Features**

- 高压高电流可靠/Reliable to high-voltage & current conditions
- 柔软易安装/Flexible and easy to handle for harnessing
- 外径2.5 mm<sup>2</sup> 至150 mm<sup>2</sup> /Range from 2.5 mm<sup>2</sup> to 150 mm<sup>2</sup>

**应用领域  
Applications**

- 电池, 储能系统  
Battery, Energy Storage

**结构尺寸/Construction & Dimensions**

料号 P/N	导体截面积 Size	导体结构 Conductor Structure (mm)	平均绝缘厚度 Insulation Av. Thickness (mm)	最小绝缘厚度 Insulation Min. Thickness (mm)	芯线外径 Dia Primary Insulation (mm)	弯曲半径 Bending Radius
AC-CP700020	2.5mm <sup>2</sup>	124/0.16	0.6	0.44	3.30± 0.2	≥ 3 X OD
AC-CP700040	4mm <sup>2</sup>	199/0.16	0.6	0.44	4.10± 0.2	≥ 3 X OD
AC-CP700060	6mm <sup>2</sup>	298/0.16	0.6	0.44	4.80± 0.2	≥ 3 X OD
AC-CP700100	10mm <sup>2</sup>	497/0.16	0.8	0.62	6.25± 0.2	≥ 3 X OD
AC-CP700160	16mm <sup>2</sup>	796/0.16	1.0	0.80	8.10± 0.2	≥ 3 X OD
AC-CP700250	25mm <sup>2</sup>	1244/0.16	1.3	1.04	10.20± 0.2	≥ 4 X OD
AC-CP700350	35mm <sup>2</sup>	1743/0.16	1.3	1.04	11.50± 0.3	≥ 4 X OD
AC-CP700500	50mm <sup>2</sup>	2492/0.16	1.5	1.20	13.60± 0.3	≥ 4 X OD
AC-CP700700	70mm <sup>2</sup>	3486/0.16	1.5	1.20	15.50± 0.3	≥ 4 X OD
AC-CP700950	95mm <sup>2</sup>	4732/0.16	1.8	1.52	18.20± 0.5	≥ 4 X OD
AC-CP701200	120mm <sup>2</sup>	5985/0.16	1.9	1.61	20.20± 0.5	≥ 5 X OD
AC-CP701500	150mm <sup>2</sup>	7467/0.16	2.1	1.79	22.50± 0.5	≥ 5 X OD

**特征 / Characteristics**

Item	Characteristics	
Rating Voltage	1500V DC	
Conductor Resistance(Max.)Ω /km@20° C	7.600Ω /km (2.5 mm <sup>2</sup> )	0.527Ω /km (35 mm <sup>2</sup> )
	4.710Ω /km (4 mm <sup>2</sup> )	0.368Ω /km (50 mm <sup>2</sup> )
	2.890Ω /km (6 mm <sup>2</sup> )	0.259Ω /km (70 mm <sup>2</sup> )
	1.820Ω /km (10 mm <sup>2</sup> )	0.196Ω /km (95 mm <sup>2</sup> )
	1.160Ω /km (16 mm <sup>2</sup> )	0.153Ω /km (120 mm <sup>2</sup> )
	0.743Ω /km (25 mm <sup>2</sup> )	0.129Ω /km (150 mm <sup>2</sup> )
Temperature Rating	-40°C to +125°C	
Flame Test	VW-1	
Withstand Voltage	6000V / 5min	
Oil Resistant Acid and Alkali Resistant		

**产品特点**  
Product Features

- IP67保护 / IP67 Protection
- 屏蔽 / Shielding
- 1-3芯可选 / 1-3 positions Available
- 一体成型 / Integrated Design

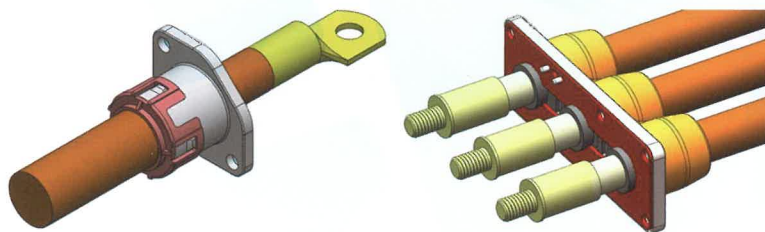

**应用领域**  
Applications

- 电池连接 / Battery Connection
- 新能源电动汽车 / New Energy Electric Vehicles
- 电动机 / Electric Motor

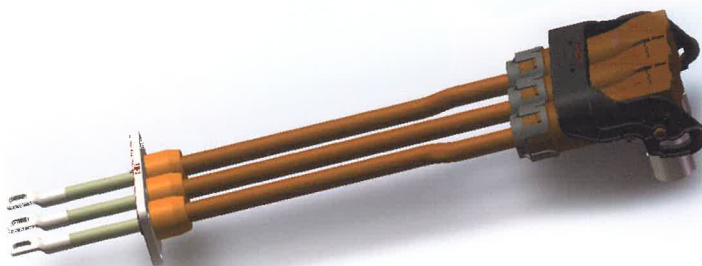

**技术参数**  
Technical Data

DC Current Rating	20 A~60 A
DC Voltage Rating	1000V
Temperature Range	-40° C to +125° C
Flammability	UL94 V-0

Recommended Cable Size & Current Rating

Series	Recommended Cbl Size (mm <sup>2</sup> )	Current Rating of Cable(A)
06 Series	16	90
	25	120
08 Series	30	150
	50	200
10 Series	70	250
	95	300

HV Flange 连接器选型信息  
HV Flange Connector Ordering Information

HV3 3 - 06 - 25  
选型例子  
Order Example

(A) Product Type	(B) Connector Type	(B) Polarization	(D) Cable Size(mm <sup>2</sup> )
HV3 HV Flange™	1. 1 POS	06 6mm	Refer to "PowerLok™ Recommended Cable Size & Current Rating" Chart
	2. 2 POS	08 8mm	
	3. 3 POS	10 10mm	



产品应用案例

电池系统连接



动力电池



超级电容

整车高压连接



整车高压01



整车高压02



整车高压03

高压控制模块连接

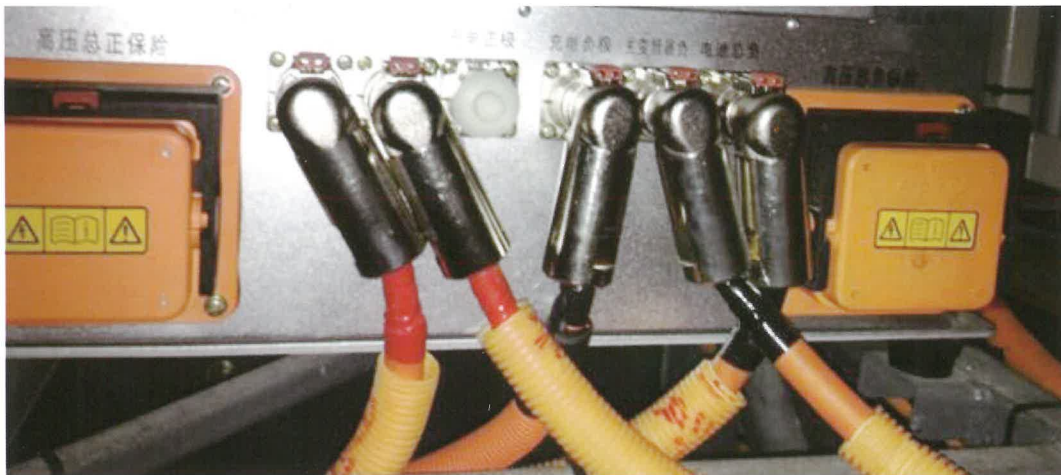

PDU 01

# Amphenol



## 技术支持和客户服务

网站: [www.amphenol-tpi.com](http://www.amphenol-tpi.com)  
企业邮箱: [CSR-ATPIG@amphenol-gasf.com](mailto:CSR-ATPIG@amphenol-gasf.com)  
联系电话: 86-20-34839801 传真: 86-20-348339800

华南地区  
联系人: 陈祥文  
联系电话: 86-188-9839-6008  
工作邮箱: [micky.chen@amphenol-gasf.com](mailto:micky.chen@amphenol-gasf.com)

华东、华北地区  
联系人: 曹辉  
联系电话: 15011785871  
工作邮箱: [kevin.cao@amphenol-gasf.com](mailto:kevin.cao@amphenol-gasf.com)

## FOR MORE INFORMATION

Technical Support and Customer Service

Internet: [www.tpii.com](http://www.tpii.com)  
North America:  
E-mail: [CSR@tpii.com](mailto:CSR@tpii.com)  
Phone: 1-204-697-2222 Fax: 1-204-694-6164

EMEA:  
Contact: Arthur Heijmerikx  
E-mail: [aheijmerikx@amphenol-aio.com](mailto:aheijmerikx@amphenol-aio.com)  
Telephone: +39 348 3145390



Компания «ЭлектроПласт» предлагает заключение долгосрочных отношений при поставках импортных электронных компонентов на взаимовыгодных условиях!

Наши преимущества:

- Оперативные поставки широкого спектра электронных компонентов отечественного и импортного производства напрямую от производителей и с крупнейших мировых складов;
- Поставка более 17-ти миллионов наименований электронных компонентов;
- Поставка сложных, дефицитных, либо снятых с производства позиций;
- Оперативные сроки поставки под заказ (от 5 рабочих дней);
- Экспресс доставка в любую точку России;
- Техническая поддержка проекта, помощь в подборе аналогов, поставка прототипов;
- Система менеджмента качества сертифицирована по Международному стандарту ISO 9001;
- Лицензия ФСБ на осуществление работ с использованием сведений, составляющих государственную тайну;
- Поставка специализированных компонентов (Xilinx, Altera, Analog Devices, Intersil, Interpoint, Microsemi, Aeroflex, Peregrine, Syfer, Eurofarad, Texas Instrument, Miteq, Cobham, E2V, MA-COM, Hittite, Mini-Circuits, General Dynamics и др.);

Помимо этого, одним из направлений компании «ЭлектроПласт» является направление «Источники питания». Мы предлагаем Вам помощь Конструкторского отдела:

- Подбор оптимального решения, техническое обоснование при выборе компонента;
- Подбор аналогов;
- Консультации по применению компонента;
- Поставка образцов и прототипов;
- Техническая поддержка проекта;
- Защита от снятия компонента с производства.



#### Как с нами связаться

**Телефон:** 8 (812) 309 58 32 (многоканальный)

**Факс:** 8 (812) 320-02-42

**Электронная почта:** [org@eplast1.ru](mailto:org@eplast1.ru)

**Адрес:** 198099, г. Санкт-Петербург, ул. Калинина, дом 2, корпус 4, литера А.