A large, light blue decorative graphic consisting of a thick, curved line that forms a partial circle, with a small circle at its top end, is centered on the page.

# **Advanced Thermal Protection for High Power LEDs with 60V LED Driver IC **ILD6070****

**Application Note AN-EVAL-ILD6070**

Revision: 2.1

Date: 22 July 2014

**Edition 2014-07-22**

**Published by  
Infineon Technologies AG  
81726 Munich, Germany**

**© 2014 Infineon Technologies AG  
All Rights Reserved.**

#### **LEGAL DISCLAIMER**

THE INFORMATION GIVEN IN THIS APPLICATION NOTE IS GIVEN AS A HINT FOR THE IMPLEMENTATION OF THE INFINEON TECHNOLOGIES COMPONENT ONLY AND SHALL NOT BE REGARDED AS ANY DESCRIPTION OR WARRANTY OF A CERTAIN FUNCTIONALITY, CONDITION OR QUALITY OF THE INFINEON TECHNOLOGIES COMPONENT. THE RECIPIENT OF THIS APPLICATION NOTE MUST VERIFY ANY FUNCTION DESCRIBED HEREIN IN THE REAL APPLICATION. INFINEON TECHNOLOGIES HEREBY DISCLAIMS ANY AND ALL WARRANTIES AND LIABILITIES OF ANY KIND (INCLUDING WITHOUT LIMITATION WARRANTIES OF NON-INFRINGEMENT OF INTELLECTUAL PROPERTY RIGHTS OF ANY THIRD PARTY) WITH RESPECT TO ANY AND ALL INFORMATION GIVEN IN THIS APPLICATION NOTE.

#### **Information**

For further information on technology, delivery terms and conditions and prices, please contact the nearest Infineon Technologies Office ([www.infineon.com](http://www.infineon.com)).

#### **Warnings**

Due to technical requirements, components may contain dangerous substances. For information on the types in question, please contact the nearest Infineon Technologies Office.

Infineon Technologies components may be used in life-support devices or systems only with the express written approval of Infineon Technologies, if a failure of such components can reasonably be expected to cause the failure of that life-support device or system or to affect the safety or effectiveness of that device or system. Life support devices or systems are intended to be implanted in the human body or to support and/or maintain and sustain and/or protect human life. If they fail, it is reasonable to assume that the health of the user or other persons may be endangered.



---

**Application Note AN-EVAL-ILD6070**

**Revision History: 22 July 2014**

**Previous Revision: 1.0**

Page	Subjects (major changes since last revision)
9	Correction for LED current

**Previous Revision: 1.1**

Figure 2	Schematic updated
----------	-------------------

**Previous Revision: 1.2**

Table 1	EN Pin changes to VB Pin
Figure 2	Figure updated
Figure 19	Figure updated

**Previous Revision: 2.0**

Figure 2	Figure updated
Figure 3	Figure updated
Figure 4	Figure updated

## Table of Contents

<b>1</b>	<b>Introduction .....</b>	<b>5</b>
<b>2</b>	<b>Application Information .....</b>	<b>6</b>
<b>3</b>	<b>Measurement Results .....</b>	<b>9</b>
<b>4</b>	<b>References .....</b>	<b>21</b>

## List of Figures

Figure 1	ILD6070 .....	5
Figure 2	Schematic of the demonstration board .....	6
Figure 3	PCB layout of the demonstration board .....	7
Figure 4	PCB photo of the demonstration board .....	7
Figure 5	Normal operation waveforms .....	9
Figure 6	Output LED current vs supply voltage .....	10
Figure 7	Analog dimming ratio vs PWM pin voltage .....	10
Figure 8	Output waveforms at $V_{PWM} = 1\text{ V}$ .....	11
Figure 9	Output waveforms at $V_{PWM} = 2\text{ V}$ .....	11
Figure 10	Contrast ratio definitions .....	12
Figure 11	Contrast ratio – PWM and LED current waveforms .....	13
Figure 12	Over Temperature Protection .....	14
Figure 13	Efficiency vs Supply voltage .....	14
Figure 14	LED current at the transition from DC to switch mode .....	15
Figure 15	Soft start with 10 $\mu\text{F}$ at the PWM pin .....	16
Figure 16	Average of LED current during the soft start with 10 $\mu\text{F}$ at the PWM pin .....	17
Figure 17	Over current protection waveforms .....	18
Figure 18	Thermal resistance of PCB-FR4 versus ground copper area .....	19
Figure 19	Thermal sensing with NTC thermistor .....	20

## List of Tables

Table 1	Bill-of-Materials .....	8
Table 2	Typical condition for measurement .....	9
Table 3	Contrast ratio calculation .....	13

## 1 Introduction

### 1.1 Features

- Wide input voltage range from 4.5 V to 60 V
- Capable to provide up to 0.7 A output current
- Up to 1 MHz switching frequency
- Soft-start capability
- Analog and PWM dimming possible
- Integrated PWM generator for analog dimming input
- Typical 3% output current accuracy
- Very low LED current drift over temperature
- Undervoltage lockout
- Over current protection
- Thermally optimized package: PG-DSO-8-27
- Adjustable over temperature protection, reducing thermal load by decreasing the current



**Figure 1** ILD6070

### 1.2 Applications

- LED driver for general lighting
- Retail, office and residential downlights
- Street and tunnel lighting
- LED ballasts

### 1.3 Product Brief

The ILD6070 is a hysteretic buck LED driver IC for driving high power LEDs in general lighting applications with average currents up to 0.7 A.

The ILD6070 is suitable for LED applications with a wide range of supply voltages from 4.5 V to 60 V. A multifunctional PWM input signal allows dimming of the LEDs with an analog DC voltage or an external PWM signal. To minimize colorshifts of the LEDs an analog PWM voltage is converted to an internal 1.6 kHz PWM signal modulating the LED current.

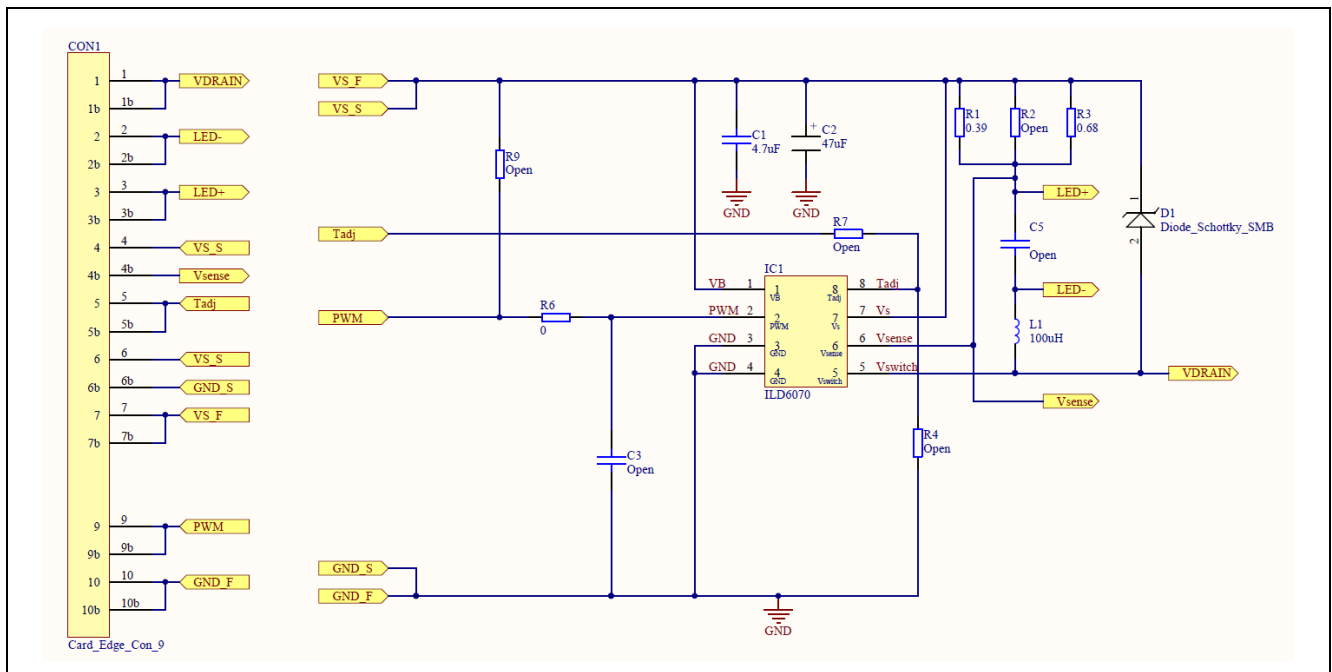
The ILD6070 incorporates an undervoltage lock-out that will shut down the IC when the minimum supply voltage threshold is exceeded. The over-current protection turns off the output stage once the output current exceeds the current threshold. An integrated over-temperature protection circuit will start to reduce the LED current by internal PWM modulation once the adjustable junction temperature threshold of the IC is exceeded. Realizing a thermal coupling between LED driver and LEDs this feature eliminates the need of external temperature sensors as NTCs or PTCs.

The hysteretic concept the current control is extremely fast and always stable. A maximum contrast ratio of 3000:1 can be achieved depending of the dimensioning of the external components. The efficiency of the LED driver is remarkable high, reaching up to 98 % of efficiency over a wide range. The output current accuracy from device to device and under all load conditions and over temperature is limited to a minimum, making ILD6070 the perfect fit for LED ballasts.

## 2 Application Information

In this application note, you will find more information about the demo board available for evaluation. The demo board is configured to have an output current of 0.5 A. The operating voltage range for the demo board can be from 4.5 V up to 60 V. The schematic, PCB layout and BOM list can be found in section 2.

### 2.1 Schematic



**Figure 2 Schematic of the demonstration board**

## 2.2 PCB Layout

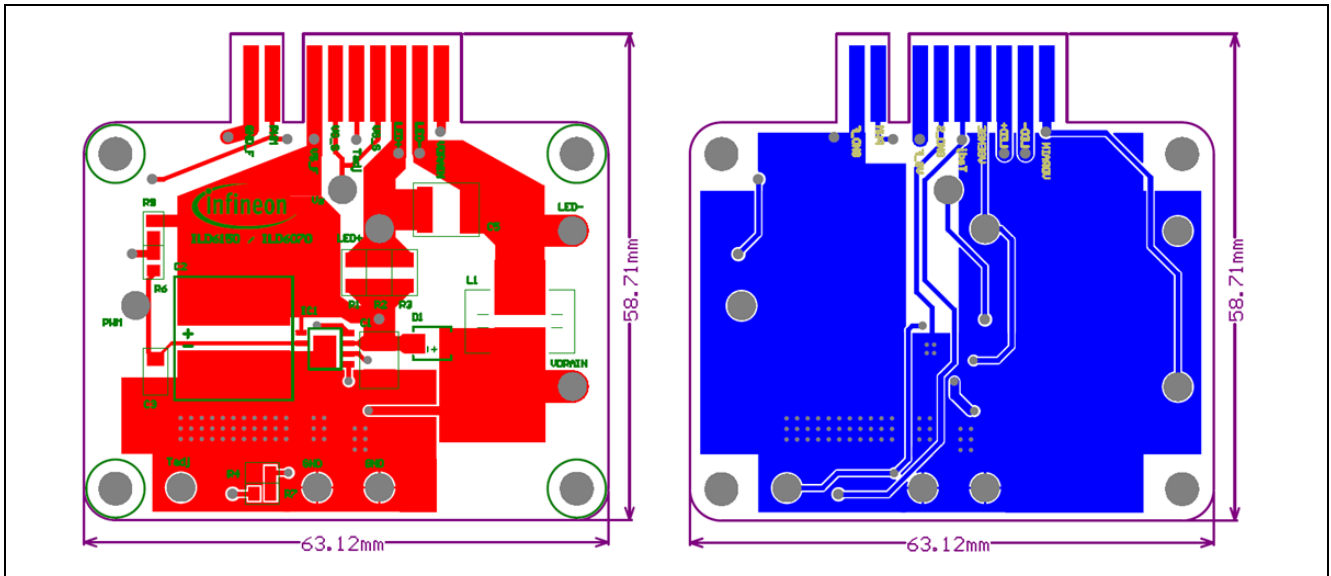


Figure 3 PCB layout of the demonstration board

## 2.3 PCB Photo

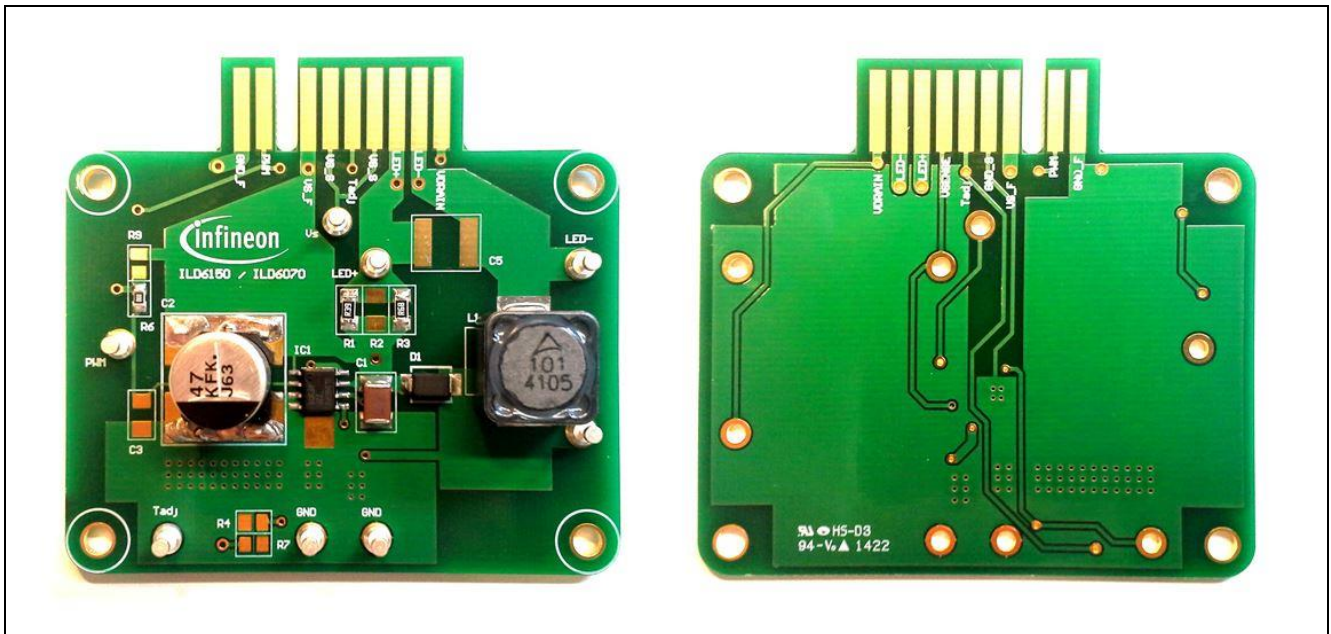


Figure 4 PCB photo of the demonstration board

**Table 1 Bill-of-Materials**

Symbol	Value	Unit	Size	Manufacturer	Comment
IC1	ILD6070		DSO-8	INFINEON	Hysteretic Buck controller and LED driver
R1	0.39	Ω	1206		Current sense resistor
R2	Open	Ω	1206		Current sense resistor
R3	0.68	Ω	1206		Current sense resistor
R4	Open	Ω	0805		Resistor for TSD adjustment
R5	0	Ω	0805		Series resistor for VB pin
R6	0	Ω	0805		Series resistor for PWM pin
R7	Open	Ω	0805		Series resistor for T <sub>adj</sub> pin
R8	0	Ω	0805		Pull-up resistor for VB pin
R9	Open	Ω	0805		Pull-up resistor for PWM pin
C1	4.7	μF	1812	TDK	C4532X7S2A475M, Ceramic, 100 V
C2	47	μF	G	PANASONIC	EEEFK1K470P, Electrolytic, 80 V
C3	Open	μF	1206		Filter capacitor for PWM pin
C4	Open	μF	1206		Filter capacitor for VB pin
C5	Open	μF	2220		Current ripple reduction capacitor
J1	0	Ω	0805		Jumper
D1	B1100-13-F		SMA	DIODES INC.	Schottky diode, 100 V, 1 A
L1	100	μH	12 x 12 mm	EPCOS	Shielded Power Inductor

The demo boards are available on request. Please contact your local sales representative for the updated information of the demo board's status.



### 3 Measurement Results

#### 3.1 LED current vs supply voltage

The average LED current is determined by the value of the external current sense resistor ( $R_{sense}$ ), formed by R1, R2 and R3 connected between  $V_s$  and  $V_{sense}$ . For ILD6070, the mean current sense threshold voltage is 125mV. The equation that determines the output LED current is given:

$$I_{OUT} = \frac{V_s - V_{sense}}{R_{sense}} = \frac{125mV}{R_{sense}}$$

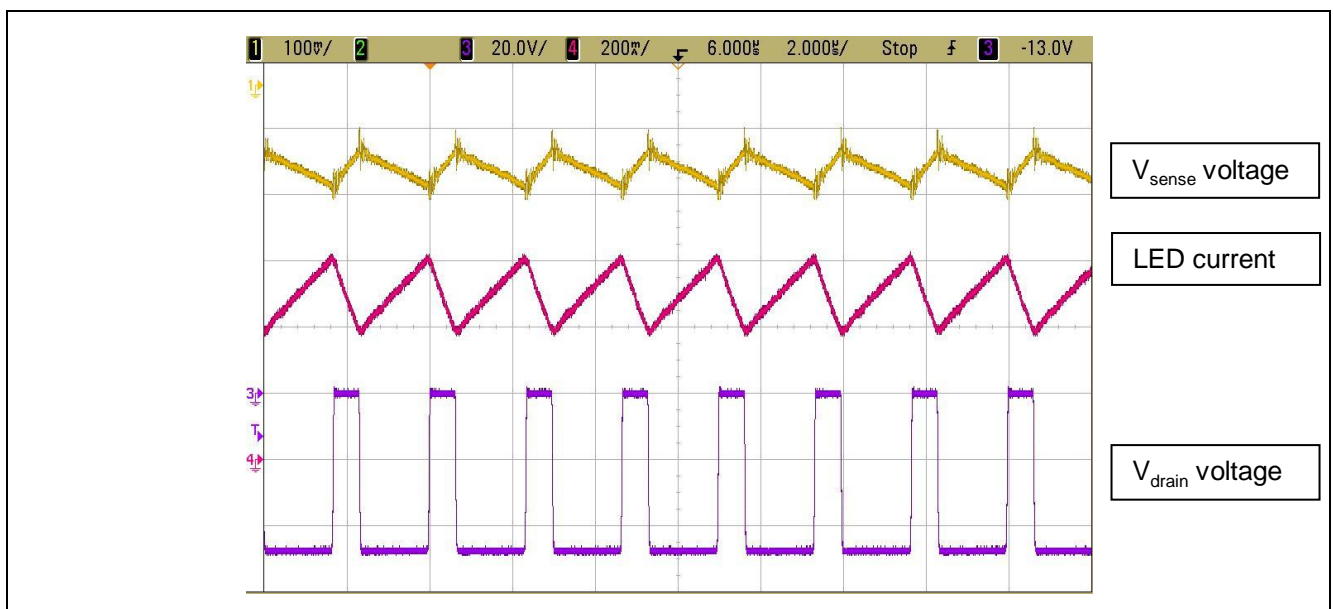
The target current setting for the demo board is 0.5 A. Based on above equation the  $R_{sense}$  is equal to 0.25  $\Omega$ . Two resistors with the value of 0.39  $\Omega$  and 0.68  $\Omega$  in parallel are chosen for the demo board.

The measurement results in this section are based on the condition below, unless otherwise specified:

**Table 2** Typical condition for measurement

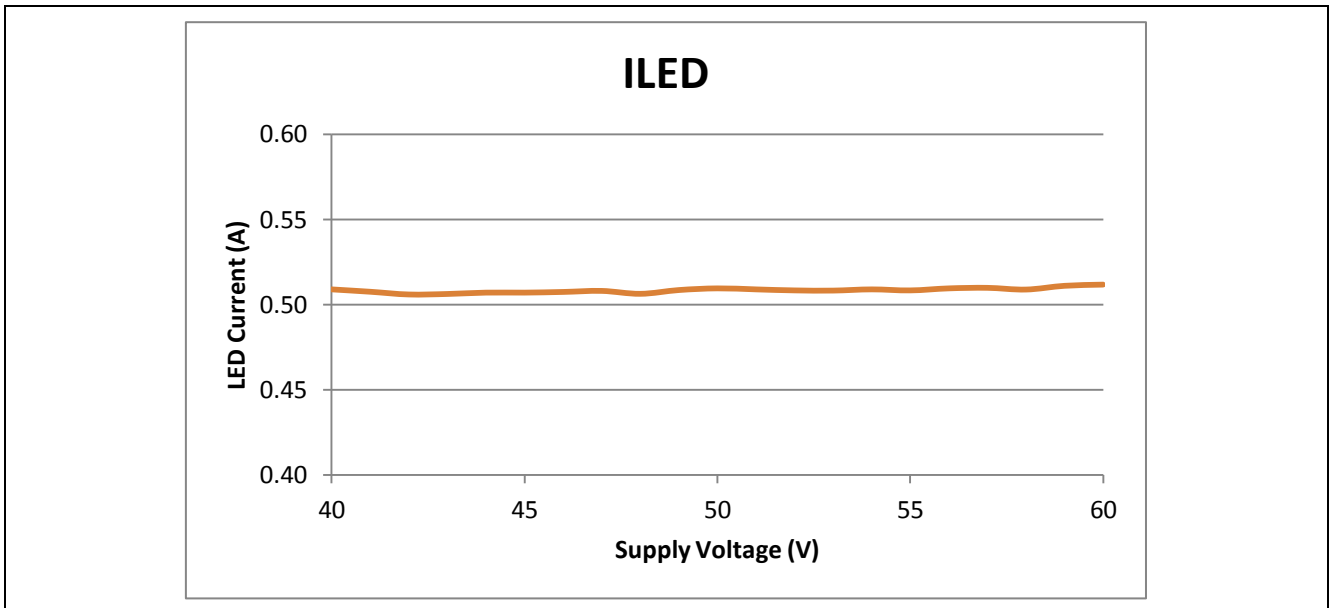
$V_s$	$R_{sense}$	Inductance	LED load
48 V	0.248 $\Omega$	100 $\mu$ H	12 pcs

Figure 5 shows the actual operating waveforms. The actual measured  $V_{sense}$  average voltage under this condition is 126 mV, and the LED current is 0.51 A. The switching frequency is 431 kHz and the internal DMOS transistor on duty-cycle is 72.4 %.



**Figure 5** Normal operation waveforms.

The ILD6070 offer a high accuracy of output current despite the changes in supply voltage. Figure 6 shows the output current vs supply voltage from the range of 40 V to 60 V. Over the supply range from 40 V to 60 V, the output LED current only deviated by 1.2 %.



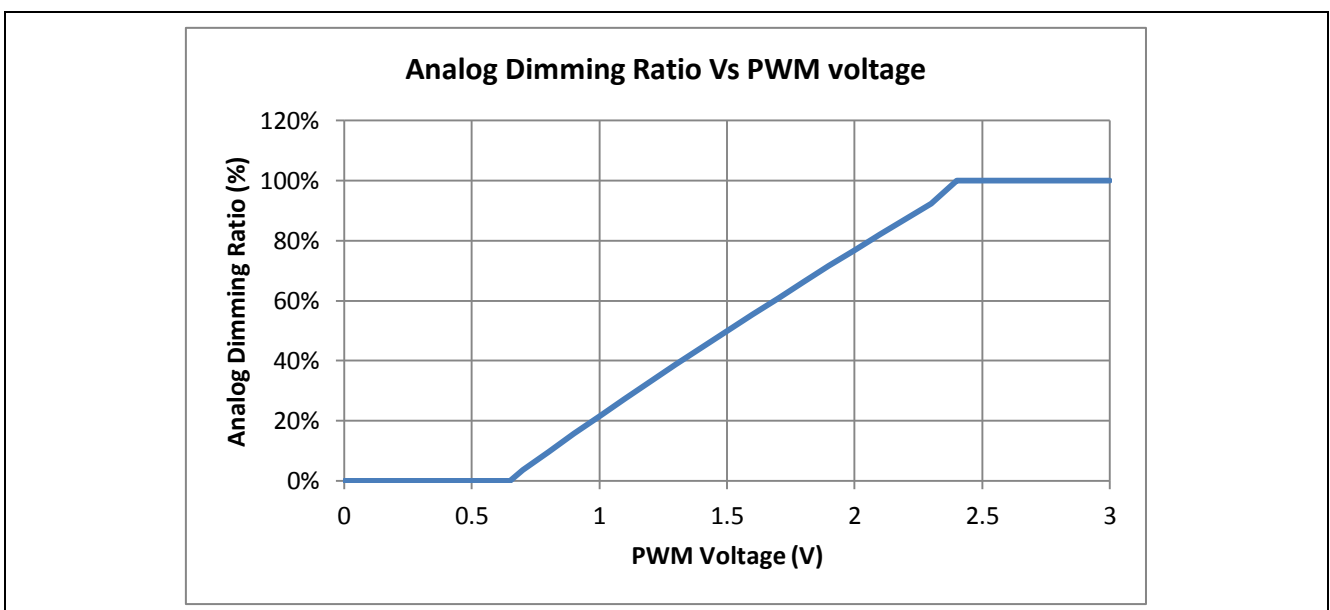
**Figure 6** Output LED current vs supply voltage.

### 3.2 Analog dimming

The multifunctional PWM input pin allows dimming of the LEDs with an analog DC voltage. To minimize the colorshifts of the LEDs, the analog DC voltage is converted into a 1.6 kHz PWM signal modulating the LED current.

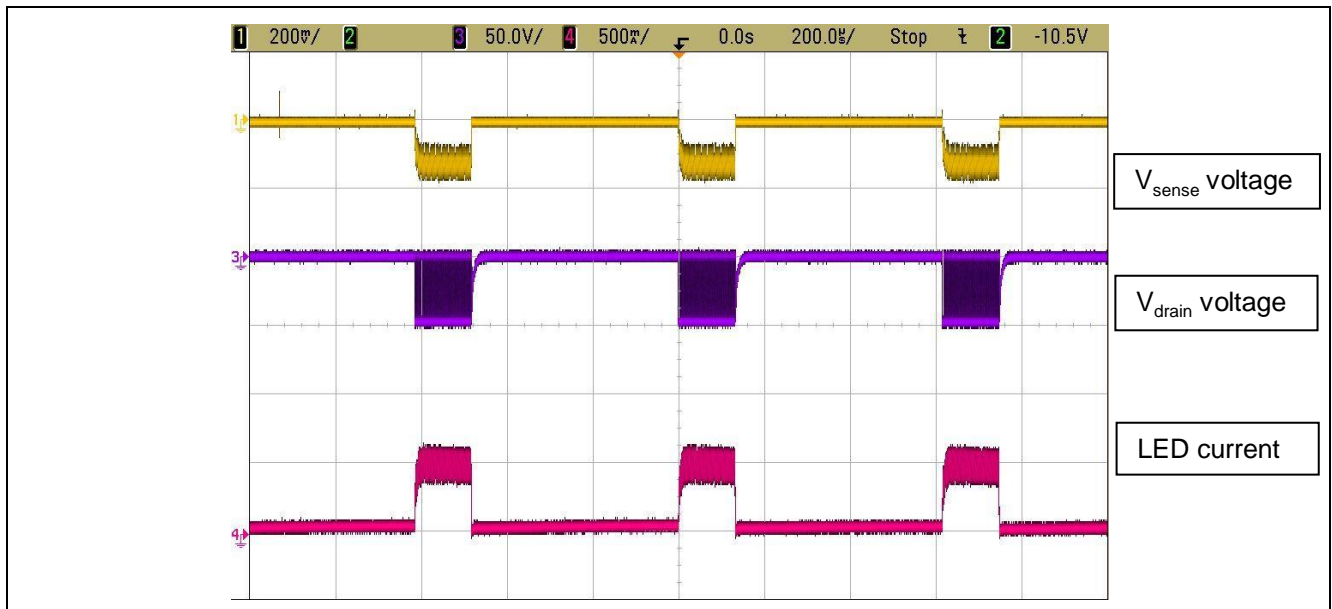
The linear range of the analog dimming is from 0.5 V to 2.5 V. LEDs is fully turned on for voltage above 2.5 V and fully turned off for voltage below 0.5 V.

Figure 7 shows the analog dimming ratio vs PWM pin voltage.

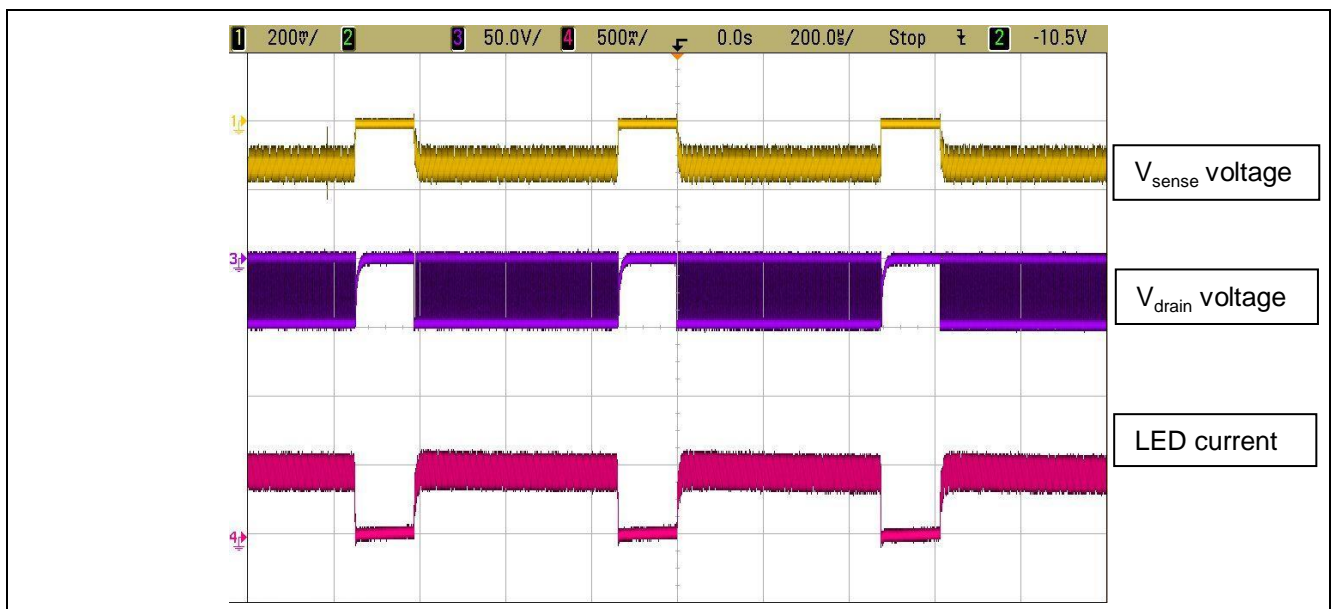


**Figure 7** Analog dimming ratio vs PWM pin voltage

Figure 8 and Figure 9 show the waveforms while the PWM pin voltage is equal to 1 V and 2 V. The output current is modulated by the internal PWM signal at 1.6 kHz.



**Figure 8** Output waveforms at  $V_{\text{PWM}} = 1 \text{ V}$ .



**Figure 9** Output waveforms at  $V_{\text{PWM}} = 2 \text{ V}$ .

The multifunctional PWM pin allows both analog and PWM input for dimming control. However, it should not be operated with combining both analog and PWM input. For example, input a PWM signal with the input voltage of low level = 0 V and high level = 1.5 V, the output current will be modulated by the internal and external PWM frequency.

### 3.3 Contrast ratio

The contrast ratio of a system depends on the dimensioning of the external components, PWM frequency as well as supply voltage. The definition of the contrast ratio (CR) is given as:

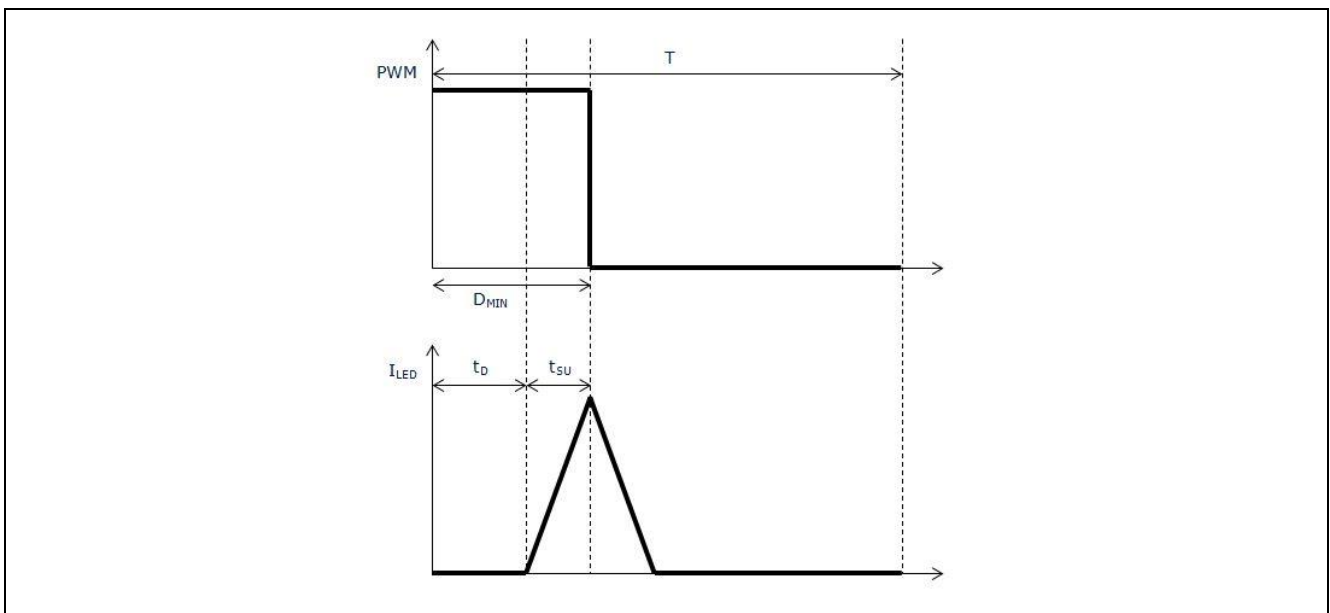
$$CR = \frac{1}{D_{MIN}}$$

Where

$$D_{MIN} = \frac{t_D + t_{SU}}{T}$$

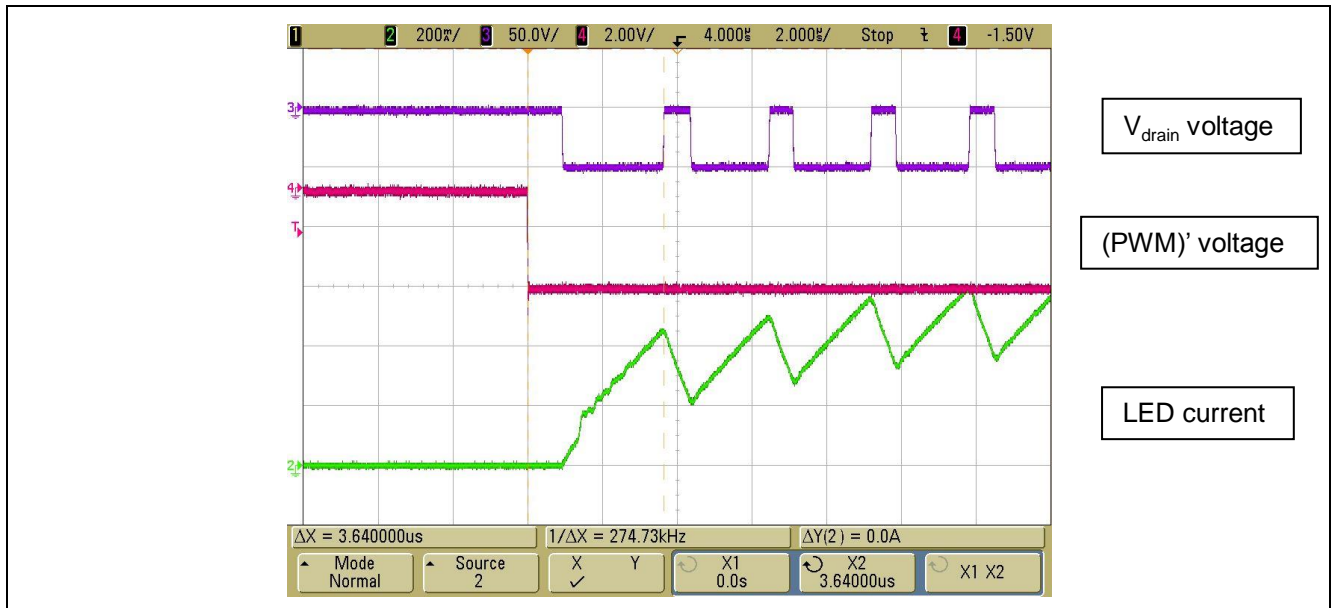
$$T = \frac{1}{f_{PWM}}$$

Figure 10 shows the relationship of the PWM and LED current waveforms.



**Figure 10 Contrast ratio definitions**

Figure 11 shows the PWM and LED current waveform and Table 3 shows the measurement results for the demo board.



**Figure 11 Contrast ratio – PWM and LED current waveforms.**

**Table 3 Contrast ratio calculation**

$f_{PWM}$	T	$t_D$	$t_{SU}$	$D_{MIN}$	CR
500 Hz	2 ms	1 $\mu$ s	2.64 $\mu$ s	$1.82 \times 10^{-3}$	540
200 Hz	5 ms	1 $\mu$ s	2.64 $\mu$ s	$7.28 \times 10^{-4}$	1300
100 Hz	10 ms	1 $\mu$ s	2.64 $\mu$ s	$3.64 \times 10^{-4}$	2700

With the PWM frequency of 500 Hz, the contrast ratio of 540:1 can be achieved. On the other hand, with the PWM frequency of 100 Hz, the contrast ratio of 2700:1 can be achieved.

### 3.4 Over temperature protection

The ILD6070 feature with an integrated over temperature protection (OTP) circuit will start to reduce the LED current by internal PWM modulation once the adjustable junction temperature threshold of the IC is exceeded. The OTP profile can be adjusted by using a resistor connect between the  $T_{adj}$  pin and GND pin.

Figure 12 shows the measurement results of OTP profile with output LED current's duty cycle vs junction temperature of the ILD6070 by using 0  $\Omega$ , 10 k $\Omega$ , 20 k $\Omega$ , 35 k $\Omega$  and open at  $T_{adj}$  pin.

With the adjustable OTP, it offers a great flexibility which the starting point of the current reduction at high temperature can be designed according to LED lamp requirement. This new OTP feature offers a great flexibility for the adjustable of the roll-off temperature and eliminates the use of the NTC/PTC thermistor in the system.

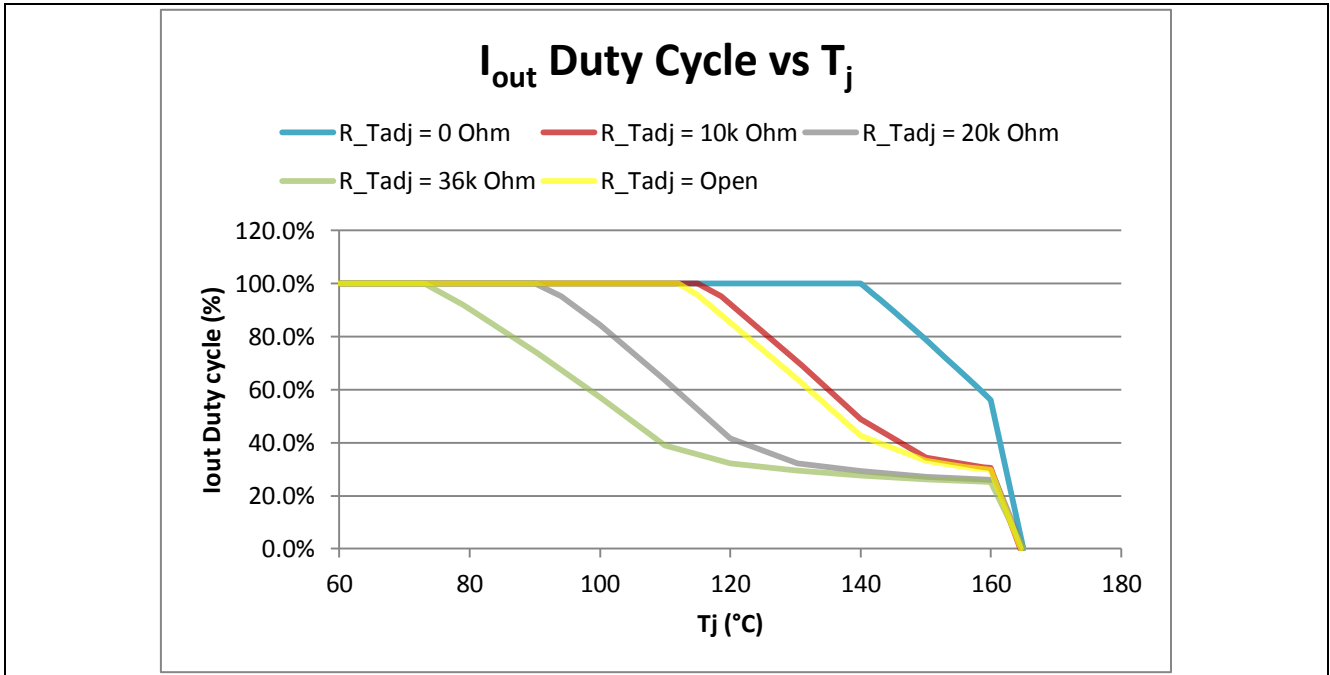


Figure 12 Over Temperature Protection.

### 3.5 Efficiency

The measurement results of efficiency of the system for  $V_s = 40\text{ V}$  to  $60\text{ V}$  can be found in Figure 13. For 12pcs LED as a load, the efficiency is keep above 92 % to 96 % in the voltage range from 40 V to 60 V.

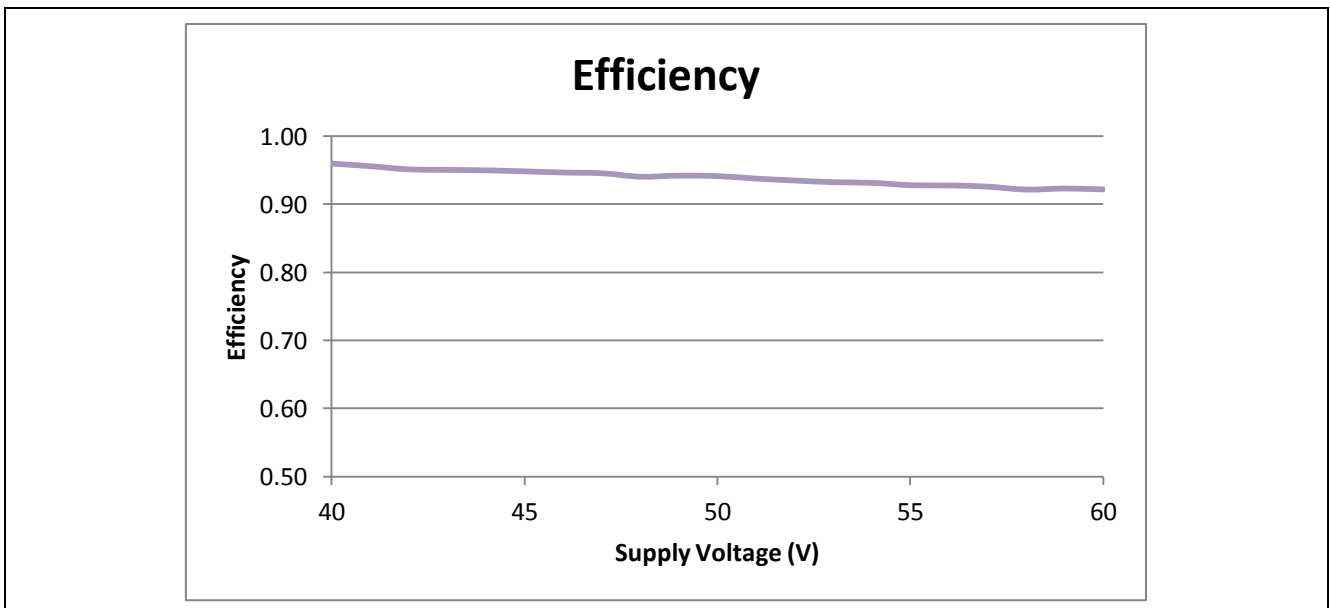


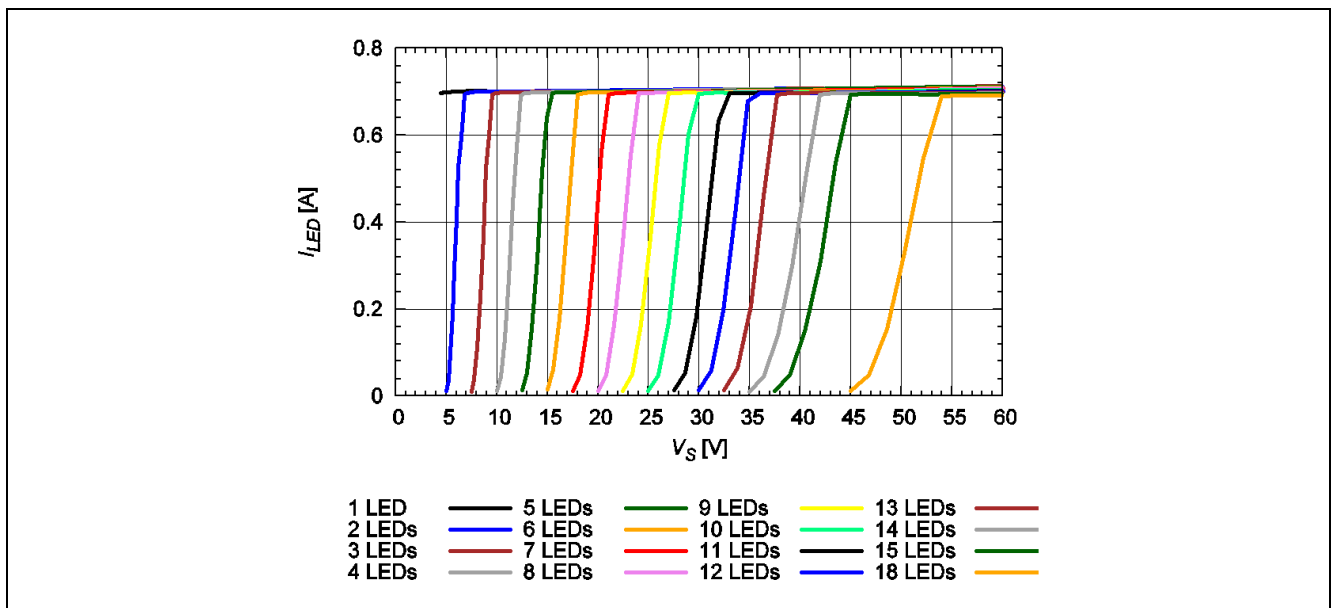
Figure 13 Efficiency vs Supply voltage.

### 3.6 Transition from DC to switch mode

While the input supply voltage is lesser or close to the LEDs load forward voltage's requirement, the output current is not reaching the target setting value. Under this condition, the ILD6070 is working in the DC mode, meaning that the DMOS is fully turned on and no switching activities.

One of the nice features that ILD6070 offer is during the transition from the DC mode to switch mode, it will not have any overshoot in the output current.

Figure 14 shows the LED current measurement results for the entire operating voltage range from 4.5 V to 60 V,  $R_{sense} = 0.178 \Omega$  with different number of LEDs as load.



**Figure 14** LED current at the transition from DC to switch mode.

### 3.7 Soft start

The soft start of the LED light can be achieved by adding a capacitor at the PWM pin. The ILD6070 having an internal current source of 18  $\mu\text{A}$  will charge up the capacitor at the PWM pin from 0 V to 4.7 V linearly. The soft start timing can be calculated using below equation:

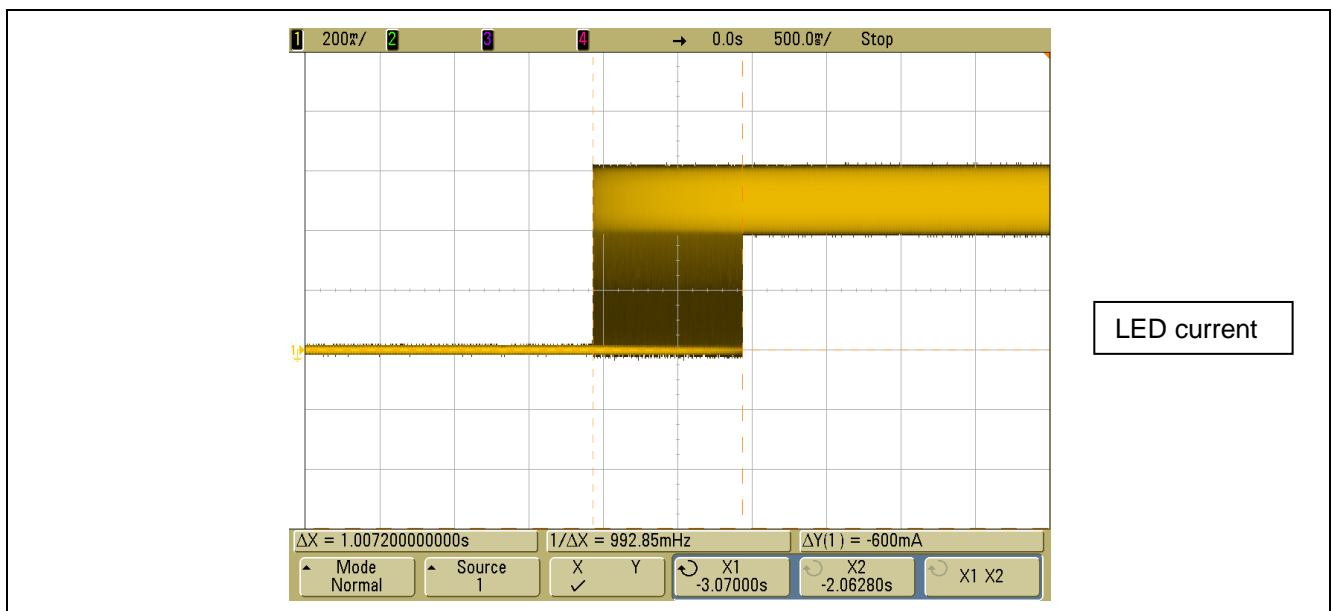
$$i = C \frac{dv}{dt}$$

$$\therefore dt = \frac{C \times dv}{i}$$

Refer to the specification of the analog dimming; the linear range of the output current from 0 % to 100 % is within the range from 0.67 V to 2.43 V. Hence the value of  $dv$  is equal to 1.76 V and the current  $i$  is equal to 18  $\mu\text{A}$ .

For example if a capacitor in the value of 10  $\mu\text{F}$  is connected to the PWM pin, the soft start timing for the light output from 0 % to 100 % require 0.978 second.

Figure 15 shows the LED current waveform which modulated by the PWM signal from 0 % to 100 % output. The actual measurement result for the soft start is 1.01 second. Figure 16 shows the average of the LED current during the soft start-up phase.



**Figure 15 Soft start with 10  $\mu\text{F}$  at the PWM pin.**



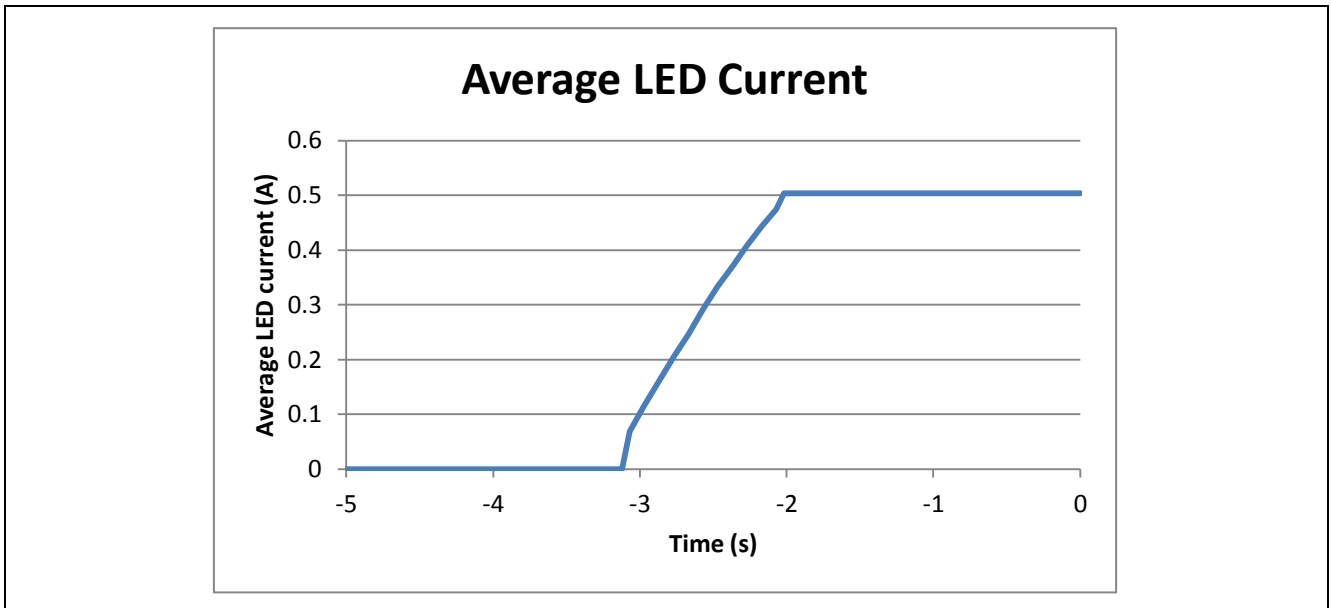


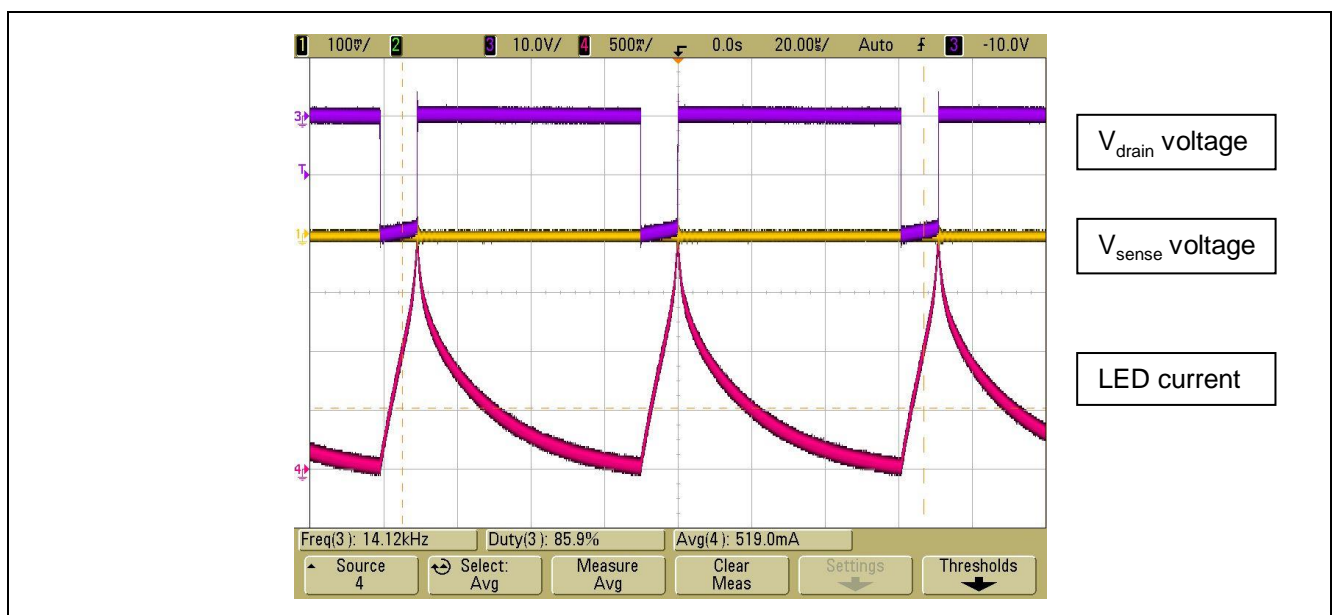
Figure 16 Average of LED current during the soft start with 10  $\mu$ F at the PWM pin.

### 3.8 Over Current Protection

The ILD6070 feature with over current protection (OCP), in case when the  $R_{sense}$  is shorted accidentally, the driver will not be damaged by the large current flowing through the internal MOSFET. However, the over current protection feature does not guarantee the protection for the LEDs load. This is because different type of LEDs having different maximum rating on the current specification. The threshold current to trigger the OCP for ILD6070 is 1.5 A.

Figure 16 below shows the waveforms where the ILD6070 in the OCP mode. The  $R_{sense}$  is shorted, the LEDs load is replaced by a 4  $\Omega$  resistor and input supply voltage is 20 V.

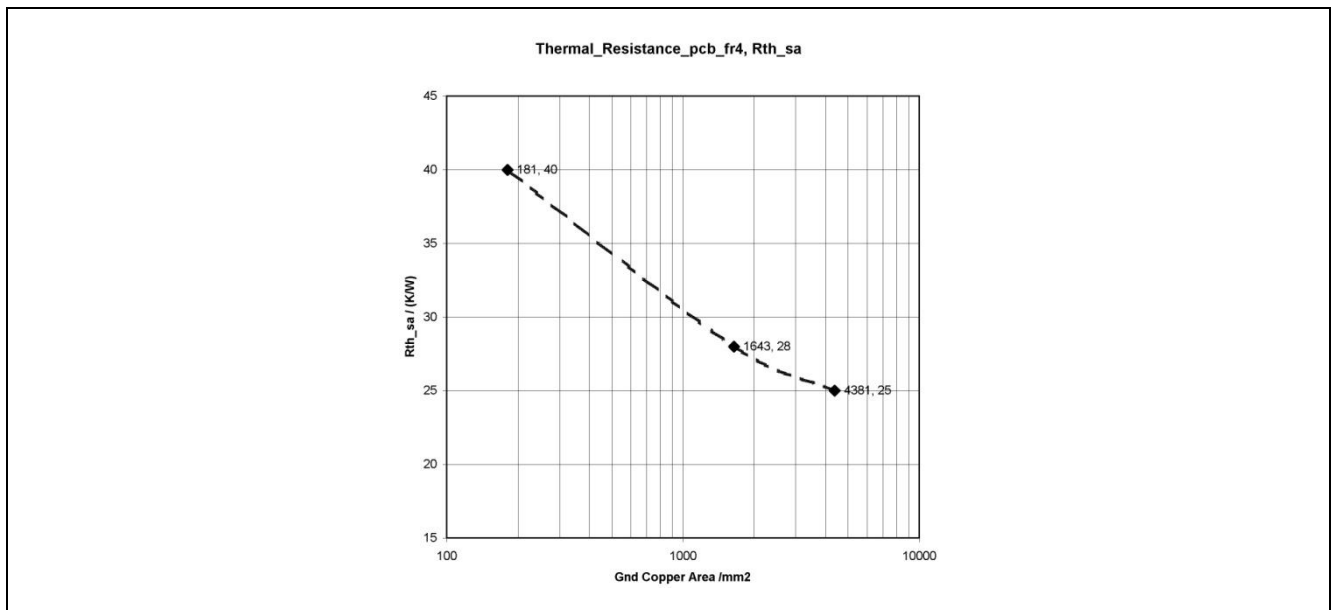
During the OCP, the MOSFET will be turned off for about 60  $\mu$ s when the 1.4 A current threshold is reached.



**Figure 17 Over current protection waveforms.**

### 3.9 PCB thermal resistance

As a reference for designing the surface area for the grounding for the PCB using FR4 to achieve a certain thermal resistance between desired solder point temperature and expected ambient temperature, the following chart can be used.



**Figure 18 Thermal resistance of PCB-FR4 versus ground copper area.**

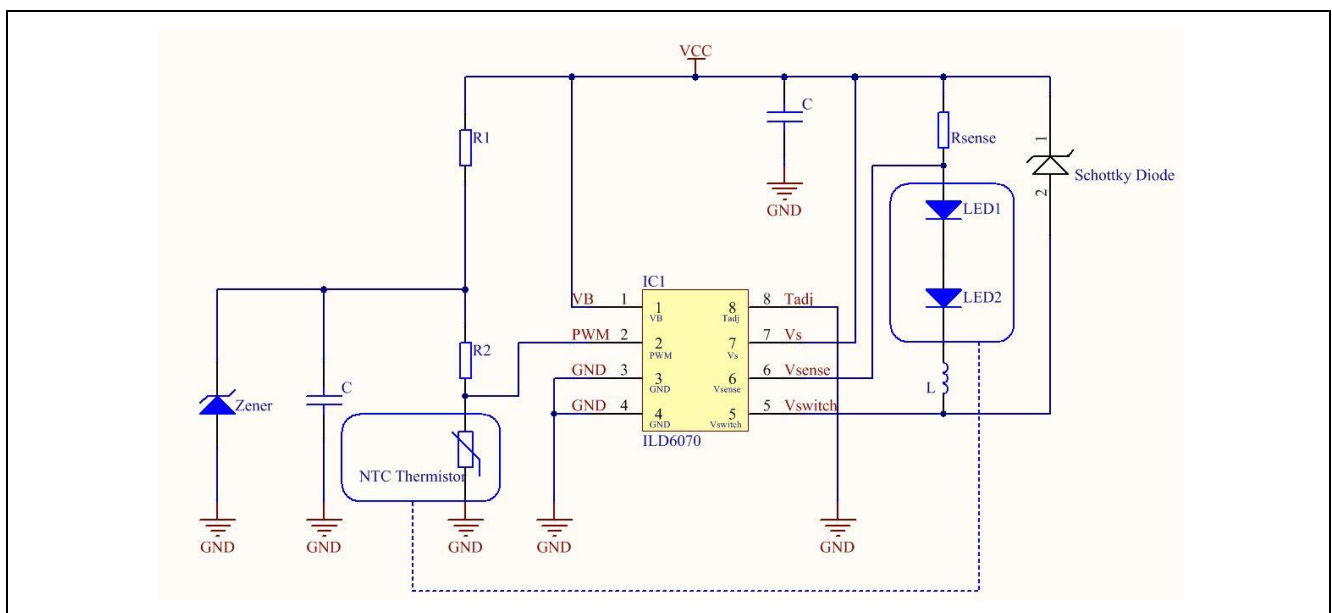
The data in the above Figure 18 were measured with the following conditions:

- Two copper layers.
- 2 oz copper (70 μm thick) and board thickness of about 1.6 mm.
- FR4 material.
- No forced convection.
- No heat sink.
- No special mask opening for improved heat dissipation.
- In the chart, only three points are marked by diamond symbol. These are measured data. The broken line represents intermediate points which can be derived by linear interpolation.

### 3.10 Thermal protection with NTC thermistor

The built-in thermal protection offers flexibility for the adjustment of roll-off temperature. However, the ILD6070 is required to be placed near the LEDs lamp to optimize this feature.

In case where the ILD6070 is placed far away from the LEDs (for example, in the electronic control gear), an external NTC thermistor can be used to realize the thermal protection. The NTC thermistor shall be placed near the LEDs to sense the temperature of the LEDs accurately. Please refer to Figure 19 for the schematic. When the NTC thermistor is heated up, the resistance of the thermistor will drop and the voltage on the PWM pin will decrease. As the DC voltage on the PWM pin decreased, the output LED current will be reduced by analog dimming and the temperature of the LEDs will be reduced also.



**Figure 19 Thermal sensing with NTC thermistor.**

## 4 References

Please refer to the ILD6070 Datasheet for more information:

[Link to ILD6070 Data sheet](#)

[www.infineon.com](http://www.infineon.com)



Компания «ЭлектроПласт» предлагает заключение долгосрочных отношений при поставках импортных электронных компонентов на взаимовыгодных условиях!

Наши преимущества:

- Оперативные поставки широкого спектра электронных компонентов отечественного и импортного производства напрямую от производителей и с крупнейших мировых складов;
- Поставка более 17-ти миллионов наименований электронных компонентов;
- Поставка сложных, дефицитных, либо снятых с производства позиций;
- Оперативные сроки поставки под заказ (от 5 рабочих дней);
- Экспресс доставка в любую точку России;
- Техническая поддержка проекта, помощь в подборе аналогов, поставка прототипов;
- Система менеджмента качества сертифицирована по Международному стандарту ISO 9001;
- Лицензия ФСБ на осуществление работ с использованием сведений, составляющих государственную тайну;
- Поставка специализированных компонентов (Xilinx, Altera, Analog Devices, Intersil, Interpoint, Microsemi, Aeroflex, Peregrine, Syfer, Eurofarad, Texas Instrument, Miteq, Cobham, E2V, MA-COM, Hittite, Mini-Circuits, General Dynamics и др.);

Помимо этого, одним из направлений компании «ЭлектроПласт» является направление «Источники питания». Мы предлагаем Вам помощь Конструкторского отдела:

- Подбор оптимального решения, техническое обоснование при выборе компонента;
- Подбор аналогов;
- Консультации по применению компонента;
- Поставка образцов и прототипов;
- Техническая поддержка проекта;
- Защита от снятия компонента с производства.



#### Как с нами связаться

**Телефон:** 8 (812) 309 58 32 (многоканальный)

**Факс:** 8 (812) 320-02-42

**Электронная почта:** [org@eplast1.ru](mailto:org@eplast1.ru)

**Адрес:** 198099, г. Санкт-Петербург, ул. Калинина, дом 2, корпус 4, литера А.