

Amphenol® Miniature Cylindrical Connectors

12-070-15

Meets MIL-C-26482, Series 1 Specifications



Amphenol

Table of Contents	Page No.
Introduction, Amphenol® Miniature Cylindrical General Information, Design Flexibility	1, 2
Connector Selection Guide	3
Insert availability	4, 5
Insert availability Breakaway Twist Pull.	6
Alternate positioning	7
Insert arrangement patterns	8-11
PT, SP, MS/PT Proprietary/MIL-C-26482, Series 1 Bayonet Coupling.	
Solder Contacts	
General Information, Specifications, Service Class	12, 13
PT00 (MS3110), SP00 wall mounting receptacle	14
PT01 (MS3111) cable connecting receptacle	15
PT02 (MS3112) SP02 box mounting receptacle	16
PT06 (MS3116) SP06 straight plug	17
PT07 (MS3114) SP07 jam nut receptacle.	18
PT08E, SP08E 90 degree plug	19
PT Connectors with Printed Circuit Board Contacts - box mount receptacle, jam nut receptacle.	20
PTB, SPB thru bulkhead receptacle.	21
General Information, Specifications - PT hermetic	22
PTIH (MS3113H) hermetic solder mounting receptacle.	23
PT02H hermetic box mounting receptacle	24
PT07H (MS3114H) hermetic jam nut receptacle	25
PT Breakaway twist pull plug	26
PT, SP, MS/PT how to order	27
PT-SE, SP-SE, MS/PT-SE Proprietary/MIL-C-26482, Series 1 Bayonet Coupling.	
Crimp Contacts	
General Information, Specifications, Service Class	28, 29
PT00SE (MS3120), SP00SE wall mounting receptacle	30
MF00SE (MS3128) wall mounting receptacle	31
PT01SE (MS3121) SP01SE cable connecting receptacle	32
PT02SE (MS3122) SP02SE box mounting receptacle	33
MF02SE (MS3127) box mounting receptacle	34
PT06SE (MS3126), SP06SE straight plug	35
PT07SE (MS3124) SP07SE jam nut receptacle	36
PT08SE, SP08SE 90 degree plug	37
PT-SE Breakaway twist pull plug	38
PT-SE, SP-SE, MS/PT-SE how to order	39
PT-CE, SP-CE Bayonet Coupling, Crimp Contacts	
General Information, Specifications, Service Class	40, 41
PT00CE, SP00CE wall mounting receptacle	42
PT01CE, cable connecting receptacle	43
PT02CE, SP02CE box mounting receptacle	44
PT06CE, SP06CE straight plug	45
PT07CE, SP07CE jam nut receptacle.	46
PT08CE, SP08CE 90 degree plug	47
PT-CE Breakaway twist pull plug	48
PT-CE, SP-CE how to order.	49
PC Threaded Coupling, Solder Contacts	
General Information, Specifications, Service Class	50, 51
PC00 wall mounting receptacle	52
PC01 cable connecting receptacle	53
PC02 box mounting receptacle	54
PC06 straight plug.	55
PC07 jam nut receptacle	56
General Information, Specifications - PC hermetic	57
PCIH hermetic solder mounting receptacle	58
PC02H hermetic box mounting receptacle	59
PC07H hermetic jam nut receptacle.	60
PC how to order	61
PC-SE, PC-CE Threaded Coupling, Crimp Contacts	
General Information, Specifications, Service Class	62
PC-SE, PC-CE how to order	63
Accessories	64-68
Application tools	69
Contacts, Power and Thermocouple Crimp.	70
Contacts, Shielded Coax	71-76
Mounting Recommendations	77
Other Amphenol Miniature Cylindrical Connectors	78, 79
Amphenol Sales Office and Authorized Distributor Listing	80

Proprietary/MIL-C-26482 Series 1 connectors covered in this catalog are widely used in general duty and environmental applications, both industrial and military.

Markets that use this family of connectors include:

- Instrumentation
- Monitoring Equipment
- Machine Tool, Factory Automation
- Communications
- Geophysical
- Industrial Controls and Robotics
- Oil and Petrochemical Industries
- Rail/Mass Transit
- Military/Aerospace

If more information is needed concerning the connectors covered in this publication, or if there are special application needs, please contact:

Amphenol Corporation
 Amphenol Aerospace
 Amphenol Industrial Operations
 40-60 Delaware Avenue
 Sidney, New York 13838-1395
 Telephone: 607-563-5011
 Fax: 607-563-5351

Please go to the Amphenol websites to view, download and save this catalog and most all of Amphenol interconnection product literature.

www.amphenol-industrial.com
www.amphenol-aerospace.com

Some miniature connector styles are available in RoHS Compliant versions. Please contact Amphenol Industrial Operations for more information.



Amphenol operates Quality Systems that are certified to ISO9001: 2000 by third party registrars.

NOTE:
 The connector products in this brochure were formerly known as Bendix® products. These products are now manufactured and sold under the Amphenol® brand name. The name "Amphenol" will replace the name "Bendix" on products and literature in the future.

NOTE:
 The Miniature MIL-C-26482, Series 2 connectors PTS-DR and MS/PTS-DR (formerly in this catalog) are no longer supplied with these designations. Amphenol now supplies the Amphenol®/Matrix® MIL-C-26482, Series 2. (Military numbers include MS3470 - MS3472, MS3474, - MS3476).

Please refer to page 78 for a brief description of the Amphenol®/Matrix® MIL-C-26482, Series 2 bayonet coupling connectors with crimp, rear insertable and rear releasable contacts, and ask for catalog 12-071 for detailed information on this series.

Amphenol® Miniature Cylindrical Connectors Proprietary/MIL-C-26482, Series 1

Amphenol® Miniature Cylindrical connectors offer twice the number of contacts in just half the size of a Standard connector. These miniature connectors, are available in several series, each with varying design characteristics and customer options to meet cost considerations and provide maximum design flexibility. There are two styles within the family that are MS approved and qualified to MIL-C-26482, Series 1, and in addition there are several proprietary styles.

Common features of all styles:

- All are for general duty applications and environmental sealing is achieved with the grommet and clamp design.
- Operating temperature is from -55°C to $+125^{\circ}$; Operating voltage to 1000 VAC (RMS) at sea level.
- Pin and socket contacts are machined from low loss copper alloy and gold plated to eliminate contact corrosion and provide an indefinite shelf life.
- All have resilient inserts which provide high dielectric strength and moisture barrier.
- A variety of shell finishes (including non-cadmium) and a variety of backend accessories are available within the styles.



PT Solder
jam nut receptacle and
mated straight plug



PT Solder
wall mount receptacle



PT-SE Crimp
wall mount receptacle
and mated straight plug



PC Threaded Crimp
straight plug and wall
mount receptacle

Bayonet Coupling with Solder Contact Termination

PT, MS/PT (solder)

- MS and proprietary versions
- Factory installed solder contacts
- 3 point bayonet coupling and 5 key/keyway mating.
- Intermateable with all miniature series connectors except threaded PC series.
- MS/PT meets MIL-C-26482 Series 1, service classes E, F and P.
- MS/PT is UL recognized.

SP (solder)

- SP Series is a modification of the PT with same features except a wider flange for back panel mounting

Options

- 7 shell styles with 60 insert patterns
- Hermetic seal (glass fusion) receptacle styles available
- Pressurized thru bulkhead receptacle style available
- Breakaway quick disconnect styles
- EMI filter protection styles
- Pre-installed coax solder contacts are available
- Printed circuit board contacts are available

Bayonet Coupling with Crimp Contact Termination

PT-SE, MS/PT-SE (crimp)

- MS and proprietary versions
- Crimp rear insertable/front release contact termination. (closed entry socket insert prevents probe damage).
- 3 point bayonet coupling and 5 key/keyway mating.
- Intermateable with all miniature series connectors except threaded PC series.
- MS/PT-SE meets MIL-C-26482 Series 1, service classes E, F, P.

SP-SE (crimp)

- Modification of the PT-SE with wider flange for back panel mounting

PT-CE, SP-CE (crimp)

- Incorporates a special one-piece insert and grommet assembly

Options

- 6 shell styles with 47 insert patterns
- Breakaway quick disconnect style available
- Coax and thermocouple contacts are available

Threaded Coupling with Solder Contact Termination

PC (solder) Proprietary

- Double stub threaded coupling and single hole polarization.
- Factory installed solder contacts

Options

- 5 shell styles with 60 insert patterns
- Hermetic receptacles available
- Pressurized thru bulkhead receptacle style available
- Pre-installed coax solder contacts are available.

Threaded Coupling with Crimp Contact Termination

Two threaded PC styles are offered in some shell sizes. Both have crimp front release and front removable contacts, but they have different retention systems.

PC-SE (crimp) Proprietary - with spring tower retention system

- Spring tower retention system

PC-CE (crimp) Proprietary - with nylon wafer dielectric system

Options

- 5 shell styles (consult Amphenol for availability of shell sizes and insert patterns)

Amphenol® Miniature Cylindrical design flexibility

The large family of miniature proprietary and MS style connectors provides for many optional features and designs. In addition to the choices of bayonet or threaded shells, solder or crimp termination within the style variations, there are additional options that are shown here.

Hermetics

Hermetically sealed receptacles have fused compression glass sealed inserts which provide environmental moisture sealing. There are three hermetic styles within the PT bayonet series and three hermetic styles within the PC threaded series.

Coaxial Contacts

Amphenol Miniature connectors can incorporate shielded coax contacts. Size 8 and 12 crimp coax contacts are available in PT-SE, SP-SE, MS/PT-SE. Factory installed size 8 and 12 solder type coax contacts are available in PT, SP,MS/PT connectors. See coax contact information pages at the end of this catalog.

Printed Circuit Board Tail Contacts

PT bayonet connectors in box mounting receptacle and jam nut receptacle styles are available with printed circuit board contacts. Standard PCB tails for MIL-C-26482 connectors have gold plating, .0050 inches over nickel. See page 20 and call Amphenol for further information.

Flex Circuitry

Flex termination assemblies for attaching cylindrical connectors to printed circuit boards are available through the Amphenol division ACT, Advanced Circuit Technology. Flex can be used with miniature 26482 connectors and it can be designed to meet specific length, current carrying capacity and to fit the precise geometric shape of the connector to board package. Flex circuitry plugs into a printed circuit board and creates a self-locking terminal pad which eliminates the need for an additional interconnect to the PCB.

Breakaway, Twist Pull Miniatures

Quick disconnect "breakaway" styles are shown in this catalogs. These are available in PT solder style plugs (page 26), PT-SE crimp style plugs (page 38) or PT-CE crimp style plugs (page 48). Quick disconnect of the connector plug from the receptacle is accomplished with axial pull on the lanyard. This instant decoupling and damage free separation is ideal for weapons release and blind or difficult accessibility situations. Separation forces vary per connector series. The plug and receptacle need to be fully mated before disengagement by the lanyard pull.

Filter Protection

Amphenol offers the FPT Series which combines the miniature PT series with an EMI filter. Designed to provide EMI protection for sensitive circuits, each circuit is individually filtered within the connector, eliminating the need for costly and bulky exterior network filters. Filter contacts are available in MF, HF, VHF, and UHF ranges and are intermateable and intermountable with MIL-C-26482 connectors. For further information see catalog 12-120, Amphenol EMI Filter Transient Protection Connectors. (online at www.amphenol-aerospace.com).

Overmolded Cable

Overmold seals and cables can be designed for almost any industrial application. A variety of materials are available: neoprene, hypalon and others; and a variety of lengths can be designed to meet customer specifications. Overmold seals to the rear of the connector and to the cable jacket providing moisture sealing.



26482 Connector with Hermetic Seal Insert and Coax Contacts



26482 Connector with PC Tail Contacts



26482 Connector with Flex



Breakaway Twist Pull 26482



26482 Connector with EMI Filter Protection



26482 Connector with Overmolded Cable

Amphenol® Miniature Cylindrical connector selection guide

The accompanying chart is provided to assist the user in selecting the appropriate type of miniature connector to meet the application requirements. Further information can be found in specific sections of this catalog.

CHARACTERISTICS		Solder				Crimp						
		PT	MS/PT	SP	PC	MS/PT-SE	PT-SE	SP-SE	PC-SE	PT-CE	SP-CE	PC-CE
Intermateable†		o	o	o	X	o	o	o	X	o	o	X
Contacts	Solder	•	•	•	•							
	Crimp RI/FR					•	•	•	•	•	•	•
Contact Retention System	Non-Removable	•	•	•	•							
	Removable					•	•	•	•	•	•	•
Coupling	Bayonet	•	•	•		•	•	•		•	•	
	Threaded				•				•			•
Standard Finishes††	Olive Drab Cadmium (003)	•	•			•	•			•		
	Anodic Coated (005)			•				•			•	
	Bright Cadmium (001)				•				•			•
Temperature Range	Resilient Dielectric (-55°C to +125°C)		•	•	•	•	•	•	•	•	•	•
Wide Mounting Flange			•				•				•	
Hermetic Seal		•	•	•	•							
SHELL STYLE AVAILABILITY												
Wall Mounting Receptacle "00"		•	•	•	•	•	**•	•	•	•	•	
Cable Connecting Receptacle "01" ***		•	•		•	•	•		•	•		•
Box Mounting Receptacle "02"		*•	•	•	*•	•	**•	•	•	•	•	
Straight Plug "06"		•	•	•	•	•	•	•	•	•	•	•
Jam Nut Receptacle "07"		*•	*•	•	*•	•	•	•	•	•	•	•
Thru-bulkhead Receptacle "TB"		•		•								
Solder Mount Receptacle "1"		*•	*•		*•							
90° Plug "08"		•		•	•		•	•	•	•	•	

RI/FR = Rear Insertion/Front Releasable

† o intermates with o

X intermates with X

†† Optional finishes available. See "how to order" sections.

* Available in hermetic version

** Dual mounting holes

*** This connector style is sometimes referred to as a cable connecting "plug." It does, however, mate with either a straight or 90 degree plug.

Amphenol®/Matrix® MIL-C-26482, Series 2 bayonet coupling connectors with rear insertable and rear releaseable contacts are covered in another catalog - See pageXX for a brief description and see complete details in catalog 12-071 which is online at www.amphenol-aerospace.com.

Amphenol[®] Miniature Cylindrical insert availability

Insert Arrangement	Solder Termination					Crimp Termination			Total Contacts	Contact Size					Service Rating
	MS/PT	PT	SP	PC	Hermetic PT MS-PT PC	MS/PT-SE PT-SE SP-SE PC-SE	PT-CE SP-CE PC-CE	20		16	12	Coax			
												12	8		
6-1		X	X	X	X*			1	1					I	
8-2	X	X	X	X	X		X	2	2					I	
8-3	X	X	X	X	X		X	3	3					I	
8-4	X	X	X	X	X		X	4	4					I	
8-33		X	X	X	X	X		3	3					I	
8-98		X	X	X				3	3					I	
10-2		X	X	X				2		2				I	
10-5		X	X	X	X*			5	5					I	
10-6	X	X	X	X	X	X	X	6	6					I	
10-70		X	X	X				1					1	Coax	
10-98	X	X	X	X	X*		X	6	6					I	
12-3	X	X	X	X	X	X	X	3		3				II	
12-4		X	X	X	X*			4		4				I	
12-8	X	X	X	X	X*	X	X	8	8					I	
12-10	X	X	X	X	X	X	X	10	10					I	
12-14		X	X	X				14	14					I	
12-98		X	X	X				10	10					I	
14-2		X	X	X				2				2		II	
14-4		S	S	S	X			4			4			I	
14-5	X	X	X	X	X	X	X	5		5				II	
14-8		X	X	X				8	6		2			I	
14-12	X	X	X	X	X	X	X	12	8	4				I	
14-15	X	X	X	X	X	X	X	15	14	1				I	
14-18	X	X	X	X	X*	X	X	18	18					I	
14-19	X	X	X	X	X	X	X	19	19					I	
14-22						X*		5	1		4			I	
14-71		P	X	X			(02CE)	4		3			1	I	
14-91 HV		S	X	X		X*		3	3					**	
14-AA		X	X	X	X			4			4			I	
16-8	X	X	X	X	X	X	X	8		8				II	
16-23	X	X	X	X		X	X	23	22	1				I	
16-26	X	X	X	X	X	X	X	26	26					I	
16-70		X	X	X				15	14			1		N/A	
16-76†††						X*		14	8		1	5		***	
16-99	X	X	X	X		X		23	21	2				I	
18-5		X	X	X		X*		5			5			II	
18-8								8			8			I	
18-11	X	X	X	X	X	X	X	11		11				II	
18-30	X	X	X	X	X*	X	X	30	29	1				I	

*Not available in MS version
 **Flashover voltage 5,000 VAC (RMS)
 ***1500 VAC (RMS)
 Sdesignates Socket insert only.

P designates Pin insert only.
 †Size 12 contacts for #10 wire
 ††Not presently tooled
 †††Contacts must be ordered separately

Amphenol® Miniature Cylindrical insert availability, cont.

Insert Arrangement	Solder Termination				Crimp Termination			Total Contacts	Contact Size					Service Rating
	MS/PT	PT	SP	PC	Hermetic PT MS-PT PC	MS/PT-SE PT-SE SP-SE PC-SE	PT-CE SP-CE PC-CE		20	16	12	Coax		
												12	8	
18-32	X	X	X	X	X	X	X	32	32					I
18-71						X*		9		8			1	Coax, II
18-72		X	X	X				14	10			4		N/A
18-75		X	X	X				4					4	Coax
18-76								4				3	1	II
18-80		X	X	X			X	8	6				2	Coax, I
18-91 HV						X*	X	6	6					**
20-16	X	X	X	X	X	X	X	16		16				II
20-24	X	X	X	X			X	24	24					I
20-25		X	X	X				25	25					I
20-26		X	X	X				26	20		6			I
20-27	X	X	X	X			X	27	27					I
20-39	X	X	X	X	X	X	X	39	37	2				I
20-41	X	X	X	X	X	X	X	41	41					I
20-70								14	10				4	Coax
20-90 HV		X	X	X				7	7					Hi-Voltage
22-7		X	X	X		X*		7					7	Coax
22-21	X	X	X	X	X	X	X	21		21				II
22-25						X*		25		25				I
22-32	X	X	X	X		X	P	32	32					I
22-34		X	X	X			X	34	34					I
22-36		X	X	X			X	36	36					I
22-41	X	X	X	X	X	X	X	41	27	14				I
22-55	X	X	X	X	X	X	X	55	55					I
22-70		X	X	X				19	13				6	I, Coax
22-71								9	2				7	I, Coax
22-72		X	X	X				19	12	4			3	N/A
22-78†††						X*		7					7	Coax
22-96						X*		7			7†			II
24-31		X	X	X			X	31		31				I
24-51						X*		51	47			4		I
24-61	X	X	X	X	X	X	X	61	61					I
24-71		X	X	X				49	45	2			2	N/A
24-79								6	1				5	Coax

*Not available in MS version
 **Flashover voltage 5,000 VAC (RMS)
 ***1500 VAC (RMS)

†Size 12 contacts for #10 wire
 ††Not presently tooled
 †††Contacts must be ordered separately

Amphenol[®] Miniature Breakaway Twist Pull insert availability

Insert Availability - Breakway Twist Pull

Insert Arrangement	Crimp Termination		Solder Termination	Total Contacts	Contact Size			
	PT-CE	PT-SE	PT		20	16	12	Service Rating
8-2	X		X	2	2			I
8-3	X		X	3	3			I
8-4	X		X	4	4			I
10-2			X	2		2		I
10-6	X	X	X	6	6			I
10-98	X		X	6	6			I
10-99	X	X		7	7			I
12-3	X	X	X	3		3		II
12-4			X	4		4		I
12-8	X	X	X	8	8			I
12-10	X	X	X	10	10			I
12-98			X	10	10			I
14-2			X	2			2	II
14-5	X	X	X	5		5		II
14-8			X	8	6		2	I
14-12	X	X	X	12	8	4		I
14-15	X	X	X	15	14	1		I
14-16			X	4		2	2	II
14-18	X	X	X	18	18			I
14-19	X	X	X	19	19			I
14-91		X	X	3	3*			H.V.
16-6			X	6			6	I
16-8	X	X	X	8		8		II
16-23	X	X	X	23	22	1		I
16-26	X	X	X	26	26			I
16-99		X	X	23	21	2		I
18-5		X	X	5			5	II
18-11	X	X	X	11		11		II
18-28		X	X	28	26	2		I
18-30	X	X	X	30	29	1		I
18-32	X	X	X	32	32			I
18-91		X	X	6	6*			H.V.
20-8			X	8		8		I
20-16	X	X	X	16		16		II
20-24	X		X	24	24			I
20-25			X	25	25			I
20-27	X		X	27	27			I
20-39	X	X	X	39	37	2		I
20-41	X	X	X	41	41			I
22-8			X	8		8		II
22-21	X	X	X	21		21		II
22-25		X		25		25		I
22-32	X	X	X	32	32			I
22-34	X		X	34	34			I
22-36	X		X	36	36			I
22-41		X	X	41	27	14		I
22-55	X	X	X	55	55			I
22-96		X		7			7†	II
22-97			X	16		16		II
22-99			X	11		11		II
24-31	X			31		31		I
24-61	X	X	X	61	61			I

For further information regarding any additional insert patterns available in Breakaway Miniature connectors, please contact Amphenol Aerospace. For availability of shielded coax contacts within Breakaway Miniature connectors contact Amphenol. The Breakaway style pages are: PT (solder) breakaway plug is on page 26, the PT-SE (crimp) breakaway plug is on page 38, and the PT-CE (crimp) breakaway plug is on page 48.

* 5KV Voltage Rating
† Size 12 contact for #10 wire.

Amphenol® Miniature Cylindrical alternate positioning

Alternate Positioning

To avoid cross-plugging problems in applications requiring the use of more than one miniature cylindrical connector of the same size and arrangement, alternate insert rotations are available as indicated in the accompanying chart.

As shown in the diagram at right, the front face of the pin insert is rotated within the shell in a clockwise direction from the normal shell key. The socket insert would be rotated counterclockwise the same number of degrees in respect to the normal shell key.



Shell Size	Insert Arrangement	Insert Rotation			
		Degrees			
		W	X	Y	Z
6	6-1	—	—	—	—
8	8-2*	58	122	—	—
8	8-3	60	210	—	—
8	8-4*	45	97	184	—
8	8-33*	90	—	—	—
8	8-98	—	—	—	—
10	10-2	45	90	315	—
10	10-5*	45	151	180	270
10	10-6*	90	—	—	—
10	10-70	—	—	—	—
10	10-98*	90	180	240	270
12	12-3*	—	—	180	—
12	12-4*	38	—	—	—
12	12-8	90	112	203	292
12	12-10*	60	155	270	295
12	12-14	—	—	—	—
12	12-98*	61	135	189	340
14	14-2	58	122	—	—
14	14-4*	45	—	—	—
14	14-5*	40	92	184	273
14	14-8	48	162	189	312
14	14-12*	43	90	—	—
14	14-15*	17	110	155	234
14	14-18*	15	90	180	270
14	14-19*	30	165	315	—
14	14-22	45	—	—	—
14	14-71	—	—	—	—
14	14-91HV	—	60	—	—
14	14-AA*	45	—	—	—
16	16-8*	54	152	180	331
16	16-23	158	270	—	—
16	16-26*	60	—	275	338
16	16-70	41	122	216	286
16	16-76	—	—	—	—
16	16-99*	66	156	223	340
18	18-5	55	97	263	315
18	18-8	180	—	—	—

Shell Size	Insert Arrangement	Insert Rotation			
		Degrees			
		W	X	Y	Z
18	18-11*	62	119	241	340
18	18-30*	180	193	285	350
18	18-32*	85	138	222	265
18	18-71	18	108	127	215
18	18-72	53	102	213	293
18	18-75	45	—	—	—
18	18-76	—	—	—	—
18	18-80	45	90	135	160
18	18-91HV	90	180	240	270
20	20-16*	238	318	333	347
20	20-24	70	145	215	290
20	20-25	72	144	216	288
20	20-26	13	107	210	322
20	20-27	72	144	216	288
20	20-39*	63	144	252	333
20	20-41*	45	126	225	—
20	20-70	63	135	222	335
20	20-90	45	135	225	315
22	22-7	19	41	—	—
22	22-21*	16	135	175	349
22	22-25	60	125	211	336
22	22-32	72	145	215	288
22	22-34	62	142	218	298
22	22-36	72	144	216	288
22	22-41	39	135	264	—
22	22-55*	30	142	226	314
22	22-70	30	82	218	312
22	22-71	33	191	236	270
22	22-72	42	200	277	339
22	22-78	19	41	—	—
22	22-96*	19	41	—	—
24	24-31	90	225	255	—
24	24-51	22	171	313	—
24	24-61*	90	180	270	324
24	24-71	39	131	205	281
24	24-79	—	—	—	—

* Available in Hermetic Class

Amphenol® Miniature Cylindrical insert arrangements

front face of pin inserts illustrated

							
Insert Arrangement	6-1	8-2	8-3	8-4	8-33	8-98	10-2
Service Rating	I	I	I	I	I	I	I
Number of Contacts	1	2	3	4	3	3	2
Contact Size	20	20	20	20	20	20	16
							
Insert Arrangement	10-5	10-6	10-70	10-98	12-3	12-4	12-8
Service Rating	I	I	Coax	I	II	I	I
Number of Contacts	5	6	1	6	3	4	8
Contact Size	20	20	8 Coax	20	16	16	20
							
Insert Arrangement	12-10	12-14	12-98	14-2	14-4	14-5	14-8
Service Rating	I	I	I	II	I	II	I
Number of Contacts	10	14	10	2	4	5	6 2
Contact Size	20	20	20	12	12	16	20 12
							
Insert Arrangement	14-12	14-15	14-18	14-19	14-22	14-71	14-91HV Flashover 5,000 VAC (RMS)
Service Rating	I	I	I	I	I	I	3
Number of Contacts	8 4	14 1	18	19	1 4	3 1	3
Contact Size	20 16	20 16	20	20	20 12	16 8 Coax	20

Amphenol[®] Miniature Cylindrical insert arrangements

front face of pin inserts illustrated



14-AA
I
4
12



16-8
II
8
16



16-23
I
22 1
20 16



16-26
I
26
20



16-70
N/A
14 1
20 12 Coax

Insert Arrangement
Service Rating
Number of Contacts
Contact Size



16-76
Flashover
1,500 VAC (RMS)
8 1 5
20 12* 2 Coax*



16-99
I
21 2
20 16

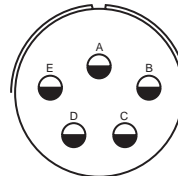

18-5
II
5
12

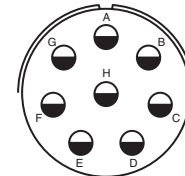

18-8
I
8
12

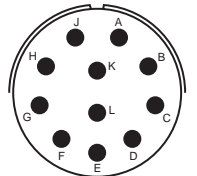

18-11
II
11
16

Insert Arrangement
Service Rating
Number of Contacts
Contact Size

*Contact Positions Optional

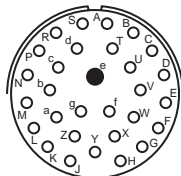

18-30
I
29 1
20 16

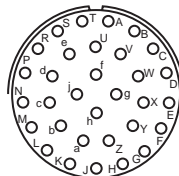

18-32
I
32
20

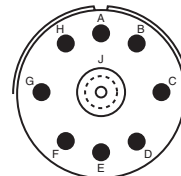

18-71
II, Coax
8 1
16 8 Coax

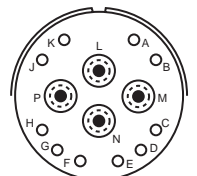

18-72
N/A
10 4
20 12 Coax

Insert Arrangement
Service Rating
Number of Contacts
Contact Size

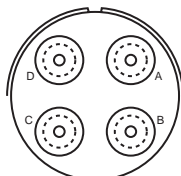

18-75
Coax
4
8 Coax

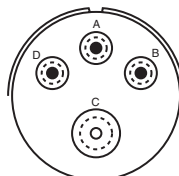

18-76
II
3 1
12 Coax 8 Coax

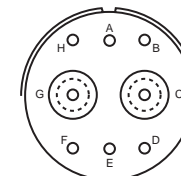

18-80
I, Coax
6 2
20 8 Coax

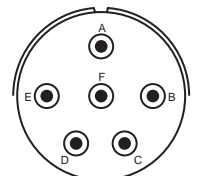

18-91 HV
Flashover
5,000 VAC (RMS)
6
20

Insert Arrangement
Service Rating
Number of Contacts
Contact Size

Amphenol® Miniature Cylindrical insert arrangements

front face of pin inserts illustrated

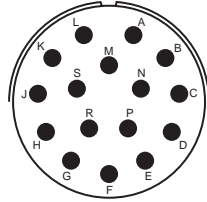

20-16
II
16
16

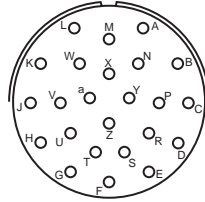

20-24
I
24
20

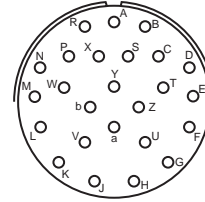

20-25
I
25
20

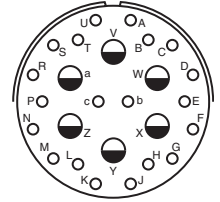

20-26
I
20 6
20 12

Insert Arrangement
Service Rating
Number of Contacts
Contact Size



20-27
I
27
20



20-39
I
37 2
20 16



20-41
I
41
20



20-70
Coax
10 4
20 8 Coax

Insert Arrangement
Service Rating
Number of Contacts
Contact Size

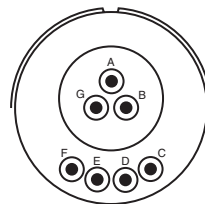

20-90
Hi-Voltage
7
20



22-7
Coax
7
8 Coax



22-21
II
21
16

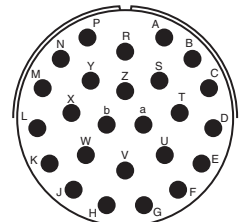

22-25
I
25
16

Insert Arrangement
Service Rating
Number of Contacts
Contact Size

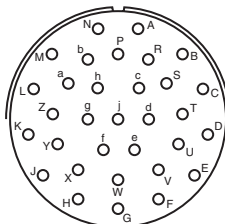

22-32
I
32
20

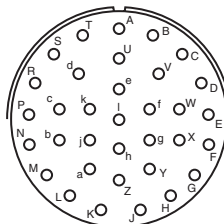

22-34
I
34
20

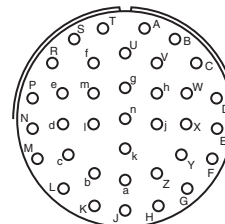

22-36
I
36
20

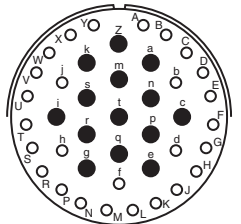

22-41
I
27 14
20 16

Insert Arrangement
Service Rating
Number of Contacts
Contact Size

Amphenol[®] Miniature Cylindrical insert arrangements

front face of pin inserts illustrated

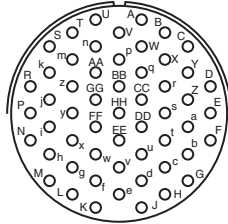

22-55

Insert Arrangement
Service Rating
Number of Contacts
Contact Size

I
55
20

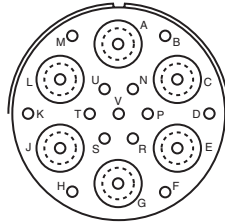

22-70

I, Coax
13 6
20 8 Coax

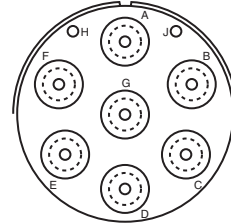

22-71

I, Coax
2 7
20 8 Coax



22-72

N/A
12 4 3
20 16 8 Coax

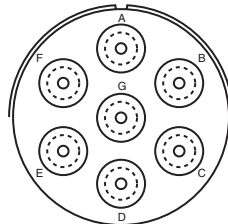

22-78

Insert Arrangement
Service Rating
Number of Contacts
Contact Size

Coax
7
8 Coax

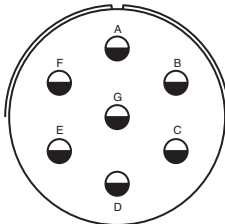

22-96

II
7
12 for
10 wire

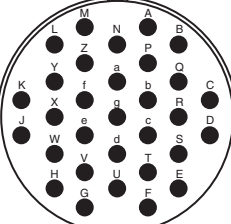

24-31

I
31
16

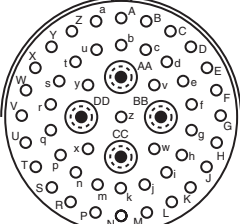

24-51

I
47 4
20 12 Coax

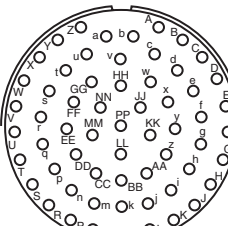

24-61

Insert Arrangement
Service Rating
Number of Contacts
Contact Size

I
61
20

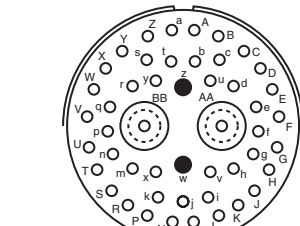

24-71

N/A
45 2 2
20 16 8 Coax

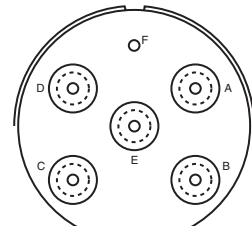

24-79

Coax
1 5
20 8 Coax

Contact Legend

Symbol	Contact Size
○	20
●	16
◐	12
⊙	HV
⊗	12 Coax
⊘	8 Coax

Amphenol® PT, SP, MS/PT

Proprietary/MIL-C-26482, Series 1

bayonet coupling and solder termination



Amphenol® solder contact miniature cylindrical connectors meet the most critical application needs. Design versatility combined with high reliability performance makes these series of Miniature Cylindrical Connectors ideal for environmental sealing or pressurized applications.

The MS/PT Series is qualified to MIL-C-26482, Series 1 and has all the outstanding design characteristics and quality of the PT Series. The SP Series is a modification of the PT, providing special shells with a wide mounting flange for back panel mounting. A corrosion resistant electrically conductive finish of cadmium plate with an olive drab chromate after-treatment is used on the PT and MS/PT. The SP is given a durable non-conductive hard anodic "Alumilite"® coating which provides abrasion protection and resistance to corrosion.

Shell components for these series are aluminum. The dependable 5 key/keyway polarization with bayonet lock coupling assures positive mating with no chance of cross plugging. Spring tension provided by a wave washer in the coupling nut ensures maintenance of interfacial seal between mating halves.

Both the insert and main joint gasket are molded from resilient neoprene. This provides excellent moisture sealing at the gasket and superior electrical isolation of the contact in the insert.

Both pins and sockets are machined from a copper alloy and are gold plated. This gold plating eliminates contact corrosion and offers an indefinite shelf life. Socket contacts for these series are a closed entry design. A breakaway style plug is available in the PT solder series. Hermetics receptacles are available in PT and MS/PT solder series. Receptacles with printed circuit board contacts are also available.

PT Solder is UL recognized under file #E115497, Vol. 1, Sec. 5. The PT, SP and MS/PT Series are intermateable and intermountable with all existing Miniature Cylindrical Series connectors except for the threaded coupling PC Series.

Refer to pages 4-11 for insert arrangement availability.

PT, SP, MS/PT

CONTACT DATA/CONNECTOR RATINGS

Contact Specifications					
Contact Size	Test Current	Maximum Millivolt Drop†	Solder Well Diameter	Solder Well Depth	
20	7.5	55	.046 +.004 -.000	.125	+.031 -.000
16	13.0	50	.078 +.005 -.003	.188	+.031 -.000
12	23.0	42	.116 +.004 -.002	.188	+.031 -.000
Service Rating					
Service Rating	Recommended Operating AC Voltage at Sea Level	Test Voltage AC (RMS), 60 cps			
		Sea Level	50,000 ft.	70,000 ft.	110,000 ft.
I	600	1,500	500	375	200
II	1,000	2,300	750	500	200

† Silver plated wire per MIL-C-26482

* This connector style is sometimes referred to as a cable connecting "plug." It does, however, mate with a straight or 90 degree plug.

PT, SP Service Classes

PT and SP connectors are available in the service classes listed below. Each class, with the exception of hermetic, offers one or more means of terminating or supporting a cable or wire bundle. Class "W" is not available in the SP Series.

- "A" General duty; back shell is threaded for conduit attachment of MS3057 cable clamp
- "A" (SR) General duty, with strain relief clamp for cable or wire bundle support
- "C" Pressurized receptacle; less than 1 cu. in. per hour leakage at 30 psi over a temperature range of -65°F to +257°F
- "E" Environmental resistant connectors - supplied with a multi-holed grommet and clamping nut for moisture-proofing individual open wires
- "E" (SR) Environmental resistant strain relief clamp and grommet for moisture proofing individual wires; provides added wire bundle support
- "J" Same as "W" class except with strain relief
- "P" Translucent nylon boot for retaining customer-applied potting compounds; held in place by a threaded ring
- "P" (SR) Strain relief clamp suitable for retaining customer applied potting compounds, with provision for wire support
- "W" Compressing clamp and neoprene gland for moisture proofing multi-conductor jacketed cables. Telescoping sleeves (MS 3420A) can be used to adapt to cables smaller than minimum close-down.
- "H"* Hermetically sealed with compression glass inserts (see pages 22-25)

Style with printed circuit board contacts- see page 20.
Breakaway style - see page 26.

MS/PT Service Classes

The MS/PT Miniature connector is available in the following certified service classes:

- "E" Environmental resistant connectors - supplied with a multi-holed grommet and clamping nut for moisture-proofing individual open wires
- "F" Grommet seal with strain relief clamp
- "P" Translucent nylon boot for retaining customer-applied potting compounds; held in place by a threaded ring



PT00 (MS3110) SP00 wall mounting receptacle



TERMINATION ASSEMBLIES

“A” General Duty/
“C” Pressurized



PT00A-XX-XXX
SP00A-XX-XXX
PT00C-XX-XXX

“A” (SR), “E” (SR), “P” (SR),
MS / “F” Strain Relief



PT00A-XX-XXX (SR)
SP00A-XX-XXX (SR)
PT00E-XX-XXX (SR)
SP00E-XX-XXX (SR)
PT00P-XX-XXX (SR)
SP00P-XX-XXX (SR)
MS3110F-XX-XXX

“E” Open Wire Seal



PT00E-XX-XXX
SP00E-XX-XXX
MS3110E-XX-XXX

“P” Potting Boot



PT00P-XX-XXX
SP00P-XX-XXX
MS3110P-XX-XXX

“W” Cable Seal

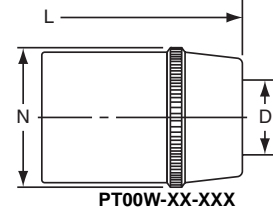

PT00W-XX-XXX

“J” Cable Seal



PT00J-XX-XXX
MS3110J-XX-XXX

To complete part number see how to order on page 27.
■ (MMC) located within .0025 of (TP)

Shell Size	Receptacle Front View				Receptacle Side View								Class “A”, “C”				
	R (TP)		S Max.		A +.001 -.005	K +.020 -.010		L Max.	M +.010 -.000		Q Thread Class 2A	Z Max.		D Min.	L Max.	N Max.	V Thread Class A
	PT	SP	PT	SP		PT	SP		PT	SP		PT	SP				
6	.469	.641	.688	.953	.348	.493	.524	.906	.431	.462	.3125-32 NEF	.468	.438	.175	1.553	.462	.3750-32 NEF
8	.594	.734	.812	1.047	.473	.493	.524	.906	.431	.462	.4375-28 UNEF	.468	.438	.297	1.553	.590	.5000-28 UNEF
10	.719	.812	.938	1.125	.590	.493	.524	.906	.431	.462	.5625-24 NEF	.468	.438	.421	1.553	.717	.6250-24 NEF
12	.812	.938	1.031	1.250	.750	.493	.524	.906	.431	.462	.6875-24 NEF	.468	.438	.546	1.553	.834	.7500-20 UNEF
14	.906	1.031	1.125	1.344	.875	.493	.524	.906	.431	.462	.8125-20 UNEF	.468	.438	.663	1.553	.970	.8750-20 UNEF
16	.969	1.125	1.219	1.438	1.000	.493	.524	.906	.431	.462	.9375-20 UNEF	.468	.438	.787	1.553	1.088	1.0000-20 UNEF
18	1.062	1.203	1.312	1.516	1.125	.493	.524	.906	.431	.462	1.0625-18 NEF	.531	.438	.879	1.553	1.216	1.1875-18 NEF
20	1.156	1.297	1.438	1.672	1.250	.650	.650	1.125	.556	.556	1.1875-18 NEF	.531	.531	1.014	1.703	1.332	1.1875-18 NEF
22	1.250	1.375	1.562	1.750	1.375	.650	.650	1.125	.556	.556	1.3125-18 NEF	.531	.531	1.134	1.703	1.460	1.4375-18 NEF
24	1.375	1.500	1.688	1.875	1.500	.683	.683	1.188	.589	.589	1.4375-18 NEF	.498	.498	1.259	1.765	1.585	1.4375-18 NEF

Shell Size	Class “A” (SR), “E” (SR), “P” (SR), MS / “F”						Class “E”, MS / “E”		Class “P”, MS / “P”			Class “W”, “J”				
	C Thread	D Min.	G Max.	H Max.	L Max.	N Max.	L Max.	N Max.	D Min.	L Max.	N Max.	D		L Max.	N Max.	XL Max.
												Closed	Free			
6	-	-	-	-	-	-	1.266	.440	.192	1.438	.484	-	-	-	-	-
8	6-32	.240	.125	.812	1.922	.550	1.266	.560	.317	1.438	.608	.168	.230	1.705	.547	2.271
10	6-32	.302	.188	.875	1.922	.675	1.266	.685	.434	1.438	.734	.205	.312	1.705	.675	2.271
12	6-32	.428	.312	1.000	1.922	.803	1.266	.813	.548	1.438	.858	.338	.442	1.848	.812	2.411
14	6-32	.552	.375	1.125	1.922	.920	1.266	.930	.673	1.438	.984	.416	.539	2.040	.940	2.599
16	6-32	.615	.500	1.188	2.047	1.047	1.266	1.057	.798	1.438	1.110	.550	.616	2.256	1.067	2.943
18	8-32	.740	.625	1.438	2.078	1.165	1.266	1.175	.899	1.438	1.234	.600	.672	2.486	1.194	3.172
20	8-32	.740	.625	1.438	2.344	1.290	1.516	1.301	1.024	1.656	1.360	.635	.747	2.922	1.322	3.610
22	8-32	.928	.750	1.625	2.344	1.418	1.516	1.430	1.149	1.656	1.484	.670	.846	3.086	1.449	3.766
24	8-32	.990	.800	1.719	2.406	1.543	1.578	1.555	1.274	1.717	1.610	.740	.894	3.310	1.576	3.985

All dimensions for reference only.

PT01 (MS3111)

cable connecting receptacle



Note: This connector style is sometimes referred to as a cable connecting "plug".
 It does, however, mate with either a straight or 90 degree plug.
 To complete part number see how to order on page 27.

PT01J-XX-XXX
 MS3111J-XX-XXX

Shell Size	Recept. Front View		Receptacle Side View						Class "A",				
	S ±.020	Y ±.020	A +.001 -.005	K +.020 -.010	L Max.	M +.016 -.000	Q Thread Class 2A	Z Max.	D Min.	L Max.	N Max.	V Thread Class A	
6	.688	.812	.348	.494	.906	.400	.3125-32 NEF	.948	.175	1.553	.462	.3750-32 NEF	
8	.812	.938	.473	.494	.906	.400	.4375-28 UNEF	.948	.297	1.553	.590	.5000-28 UNEF	
10	.938	1.062	.590	.494	.906	.400	.5625-24 NEF	.948	.421	1.553	.717	.6250-24 NEF	
12	1.031	1.156	.750	.494	.906	.400	.6875-24 NEF	.948	.546	1.553	.834	.7500-20 UNEF	
14	1.125	1.250	.875	.494	.906	.400	.8125-20 UNEF	.948	.663	1.553	.970	.8750-20 UNEF	
16	1.219	1.344	1.000	.494	.906	.400	.9375-20 UNEF	.948	.787	1.553	1.088	1.0000-20 UNEF	
18	1.312	1.438	1.125	.494	.906	.400	1.0625-18 NEF	.948	.879	1.553	1.216	1.1875-18 NEF	
20	1.438	1.562	1.250	.650	1.125	.535	1.1875-18 NEF	1.166	1.041	1.703	1.332	1.1875-18 NEF	
22	1.562	1.688	1.375	.650	1.125	.535	1.3125-18 NEF	1.166	1.135	1.703	1.460	1.4375-18 NEF	
24	1.688	1.812	1.500	.683	1.188	.568	1.4375-18 NEF	1.166	1.259	1.765	1.585	1.4375-18 NEF	

Shell Size	Class "A" (SR), "E" (SR), "P" (SR), MS / "F"						Class "E", MS / "E"		Class "P", MS / "P"			Class "W", "J"				
	C Thread	D Min.	G Max.	H Max.	L Max.	N Max.	L Max.	N Max.	D Min.	L Max.	N Max.	D		L Max.	N Max.	XL Max.
												Closed	Free			
6	-	-	-	-	-	-	1.266	.440	.192	1.438	.484	-	-	-	-	-
8	6-32	.240	.125	.812	1.922	.550	1.266	.560	.317	1.438	.608	.168	.230	1.705	.547	2.271
10	6-32	.302	.188	.875	1.922	.675	1.266	.685	.434	1.438	.734	.205	.312	1.705	.675	2.271
12	6-32	.428	.312	1.000	1.922	.803	1.266	.813	.548	1.438	.858	.338	.442	1.848	.812	2.411
14	6-32	.552	.375	1.125	1.922	.920	1.266	.930	.673	1.438	.984	.416	.539	2.040	.940	2.599
16	6-32	.615	.500	1.188	2.047	1.047	1.266	1.057	.798	1.438	1.110	.550	.616	2.256	1.067	2.943
18	8-32	.740	.625	1.438	2.078	1.165	1.266	1.175	.899	1.438	1.234	.600	.672	2.486	1.194	3.172
20	8-32	.740	.625	1.438	2.344	1.290	1.516	1.301	1.024	1.656	1.360	.635	.747	2.922	1.322	3.610
22	8-32	.928	.750	1.625	2.344	1.418	1.516	1.430	1.149	1.656	1.484	.670	.846	3.086	1.449	3.766
24	8-32	.990	.800	1.719	2.406	1.543	1.578	1.555	1.274	1.717	1.610	.740	.894	3.310	1.576	3.985

All dimensions for reference only.

PT02 (MS3112) SP02 box mounting receptacle

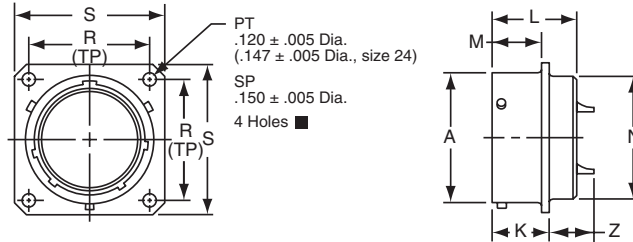

- PT02A-XX-XXX
- SP02A-XX-XXX
- * PT02C-XX-XXX
- * SP02C-XX-XXX
- * PT02E-XX-XXX
- * SP02E-XX-XXX
- MS3112E-XX-XXX
- * PT02P-XX-XXX
- * SP02P-XX-XXX
- MS3112P-XX-XXX
- * PT02W-XX-XXX
- * SP02W-XX-XXX

To complete part number see how to order on page 27.

■ (MMC) located within .0025 of (TP)

* The PT02 and SP02 box mounting receptacles are made only to complete a series; no provision is made for accessories or potting on the rear skirt.

Shell Size	Receptacle Front View				Receptacle Side View								
	R (TP)		S		A +.001 -.005	K +.020 -.010		L Max.	M +.010 -.000		N Dia. Max.	Z Max.	
	PT	SP	PT	SP		PT	SP		PT	SP		PT	SP
6	.469	.641	.688	.953	.348	.493	.524	.825	.431	.462	.323	.465	.438
8	.594	.734	.812	1.047	.473	.493	.524	.825	.431	.462	.449	.465	.438
10	.719	.812	.938	1.125	.590	.493	.524	.825	.431	.462	.573	.465	.438
12	.812	.938	1.031	1.250	.750	.493	.524	.825	.431	.462	.699	.465	.438
14	.906	1.031	1.125	1.344	.875	.493	.524	.825	.431	.462	.823	.465	.438
16	.969	1.125	1.219	1.438	1.000	.493	.524	.825	.431	.462	.949	.465	.438
18	1.062	1.203	1.312	1.516	1.125	.493	.524	.825	.431	.462	1.073	.465	.438
20	1.156	1.297	1.438	1.672	1.250	.650	.650	1.076	.556	.556	1.199	.526	.531
22	1.250	1.375	1.562	1.750	1.375	.650	.650	1.076	.556	.556	1.323	.526	.531
24	1.375	1.500	1.688	1.875	1.500	.683	.683	1.109	.589	.589	1.449	.493	.497

All dimensions for reference only.

PT06 (MS3116)

SP06

straight plug



To complete part number see how to order on page 27.

Shell Size	Plug Front View		Plug Side View				Class "A"			
	S Max.	J	L Max.	Q Thread Class 2A	Z Max.	D Min.	L Max.	N Max.	V Thread Class A	
6	.625	.353	.906	.3125-32 NEF	.594	.175	1.609	.462	.3750-32 NEF	
8	.750	.353	.906	.4375-28 UNEF	.594	.297	1.609	.590	.5000-28 UNEF	
10	.859	.353	.906	.5625-24 NEF	.594	.421	1.609	.717	.6250-24 NEF	
12	1.013	.353	.906	.6875-24 NEF	.594	.546	1.609	.834	.7500-24 NEF	
14	1.156	.353	.906	.8125-20 UNEF	.594	.663	1.609	.970	.8750-20 UNEF	
16	1.281	.353	.906	.9375-20 UNEF	.594	.787	1.609	1.088	1.0000-20 UNEF	
18	1.319	.353	.906	1.0625-18 NEF	.594	.879	1.609	1.216	1.1875-18 NEF	
20	1.531	.415	1.062	1.1875-18 NEF	.672	1.014	1.656	1.332	1.1875-18 NEF	
22	1.656	.415	1.062	1.3125-18 NEF	.672	1.135	1.656	1.460	1.4375-18 NEF	
24*	1.776	.415	1.125	1.4375-18 NEF	.672	1.259	1.750	1.587	1.4375-18 NEF	

Shell Size	Class "A" (SR), "E" (SR), "P" (SR), MS / "F"						Class "E", MS / "E"		Class "P", MS / "P"			Class "W", "J"				
	C Thread	D Min.	G ±.010	H Max.	L Max.	N Max.	L Max.	N Max.	D Min.	L Max.	N Max.	D		L Max.	N Max.	XL Max.
6	—	—	—	—	—	—	1.266	.440	.192	1.526	.484	Closed	Free	—	—	—
8	6-32	.240	.125	.812	1.906	.550	1.266	.560	.317	1.526	.608	.168	.230	1.705	.547	2.271
10	6-32	.302	.188	.875	1.906	.675	1.266	.685	.434	1.526	.734	.205	.312	1.705	.675	2.271
12	6-32	.428	.312	1.000	1.906	.803	1.266	.813	.548	1.526	.858	.338	.442	1.848	.812	2.411
14	6-32	.552	.375	1.125	1.906	.920	1.266	.930	.673	1.526	.984	.416	.539	2.040	.940	2.599
16	6-32	.615	.500	1.188	2.047	1.047	1.266	1.057	.798	1.526	1.110	.550	.616	2.256	1.067	2.943
18	8-32	.740	.625	1.438	2.078	1.165	1.266	1.175	.899	1.526	1.234	.600	.672	2.486	1.194	3.172
20	8-32	.740	.625	1.438	2.250	1.290	1.438	1.301	1.024	1.546	1.360	.635	.747	2.844	1.322	3.610
22	8-32	.928	.750	1.625	2.250	1.418	1.438	1.430	1.149	1.546	1.484	.670	.846	3.000	1.449	3.766
24*	8-32	.990	.800	1.750	2.312	1.543	1.500	1.555	1.274	1.656	1.610	.740	.894	3.210	1.576	3.985

* Available in PT06 only
 All dimensions for reference only.

PT07 (MS3114) SP07 jam nut receptacle



"A" General Duty/
"C" Pressurized Receptacle
PT07A-XX-XXX
PT07C-XX-XXX

"E" Open Wire Seal



PT07E-XX-XXX
SP07E-XX-XXX
MS3114E-XX-XXX

TERMINATION ASSEMBLIES
"A" (SR), "E" (SR), "P" (SR), MS / "F" Strain Relief



PT07A-XX-XXX (SR)
SP07A-XX-XXX (SR)
PT07E-XX-XXX (SR)
MS3114F-XX-XXX

"P" Potting Boot



PT07P-XX-XXX (SR)
MS3114P-XX-XXX

To complete part number see how to order on page 27.

Shell Size	Recept. Front View		Receptacle Side View						Class "E", MS / "E"					
	H	S	A Dia.	J Flat	K	M	P Panel Thickness		R Thread	Z	L Max.	M	N Max.	Z ±.040
	±.016		+.001 -.005	+.000 -.010	+.011 -.010		Min.	Max.						
6	.625	.812	.348	.405	.125	.696	.062	.125	.4375-28	.231	.568	.696	.604	.191
8	.750	.938	.473	.530	.125	.696	.062	.125	.5625-24	.231	.568	.696	.729	.191
10	.875	1.062	.590	.655	.125	.696	.062	.125	.6875-24	.231	.568	.696	.854	.191
12	1.062	1.250	.750	.818	.125	.696	.062	.125	.8750-20	.231	.568	.696	.979	.191
14	1.188	1.375	.875	.942	.125	.696	.062	.125	1.0000-20	.231	.568	.696	1.104	.191
16	1.312	1.500	1.000	1.066	.125	.696	.062	.125	1.1250-18	.231	.568	.696	1.229	.191
18	1.438	1.625	1.125	1.191	.125	.696	.062	.125	1.2500-18	.231	.568	.696	1.354	.191
20	1.562	1.812	1.250	1.316	.156	.884	.062	.250	1.3750-18	.261	.630	.884	1.510	.221
22	1.688	1.938	1.375	1.441	.156	.884	.062	.250	1.5000-18	.261	.630	.884	1.635	.221
24	1.816	2.062	1.500	1.566	.156	.917	.062	.250	1.6250-18	.228	.660	.917	1.760	.188

Shell Size	Class "A" (SR), "P" (SR), MS / "F"						Class "E" (SR)						Class "P", MS / "P"				
	C Thread	D Max.	G	H	L	M	C Thread	D Max.	G	H	L	M	D Max.	L +.010 -.026	M	N	Z
6	-	-	-	-	-	-	-	-	-	-	-	-	.202	.593	.696	.484	.191
8	6-32	.250	.125	.781	1.062	.696	6-32	.250	.125	.775	1.029	.696	.327	.593	.696	.608	.191
10	6-32	.312	.188	.844	1.062	.696	6-32	.312	.188	.837	1.029	.696	.444	.593	.696	.734	.191
12	6-32	.438	.312	.969	1.062	.696	6-32	.438	.312	.963	1.029	.696	.558	.593	.696	.858	.191
14	6-32	.562	.375	1.094	1.062	.696	6-32	.562	.375	1.087	1.029	.696	.683	.593	.696	.984	.191
16	6-32	.625	.500	1.156	1.188	.696	6-32	.625	.500	1.150	1.161	.696	.808	.593	.696	1.110	.191
18	8-32	.750	.625	1.406	1.188	.696	8-32	.750	.625	1.400	1.161	.696	.909	.593	.696	1.234	.191
20	8-32	.750	.625	1.406	1.250	.884	8-32	.750	.625	1.400	1.224	.884	1.034	.718	.884	1.360	.221
22	8-32	.938	.750	1.594	1.250	.884	8-32	.938	.750	1.587	1.224	.884	1.159	.718	.884	1.484	.221
24*	8-32	1.000	.800	1.594	1.250	.917	8-32	1.000	.800	1.681	1.320	.917	1.284	.718	.917	1.610	.188

* Size 24 strain relief available in PT only.

All dimensions for reference only.

PT08 E SP08 E 90 degree plug

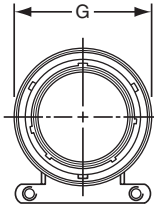

TERMINATION ASSEMBLIES

"E" Open Wire Seal, "E" (SR) Strain Relief



PT08E-XX-XXX
SP08E-XX-XXX
PT08E-XX-XXX (SR)
SP08E-XX-XXX (SR)



"P" Potting Boot 75 degrees



PT08P-XX-XXX
SP08P-XX-XXX



To complete part number see how to order on page 27.
All lockwire holes are .044 Dia. Min.

Shell Size	Plug Front View	Plug Side View								
	G Dia. Max.	Class "E", "E" (SR)					Class "P"			
		B ±.031	C +.010 -0.025	D ±.062	E +.047 -0.025	L ±.057	A ±.025	H ±.015	K ±.015	L Max.
8	.796	.655	.169	.941	.339	1.786	.469	.312	.438	1.656
10	.921	.749	.170	1.191	.393	1.880	.547	.438	.562	1.781
12	1.046	.812	.264	1.191	.450	1.965	.625	.516	.688	1.843
14	1.171	.905	.310	1.254	.519	2.113	.734	.625	.781	1.953
16	1.297	1.030	.330	1.316	.583	2.315	.750	.656	.890	2.000
18	1.422	1.015	.444	1.562	.621	2.423	.781	.703	1.000	2.046
20	1.562	1.077	.510	1.625	.683	2.695	.859	.766	1.125	2.218
22	1.672	1.139	.515	1.719	.739	2.742	.906	.812	1.234	2.265
24	1.797	1.265	.656	1.751	.797	2.980	1.169	.918	1.374	2.624

All dimensions for reference only.

PT Connectors with Printed Circuit Board Contacts

Box Mounting Receptacle (PT02) with PCB Contacts

Order by applicable part number in chart below; add insert arrangement number. Refer to insert availability on pages 4-11.

■ (MMC) located within .0025 of (TP)

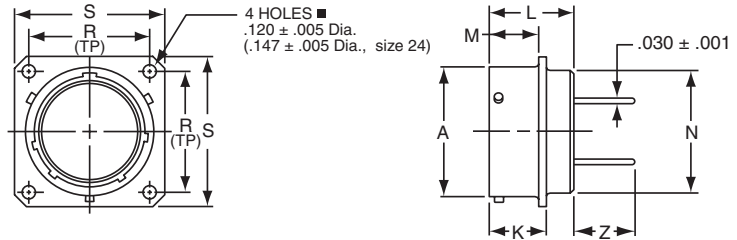

Shell Size	Part Number* PT02 with PCB Contacts	Receptacle Front View		Receptacle Side View					
		R (TP)	S +.011 -.010	A +.001 -.005	K +.021 -.010	L Max.	M +.010 -.000	N Dia. Max.	Z +.040 -.050
6	71-570120-XXX	.469	.688	.348	.493	.825	.431	.323	.380
8	71-570121-XXX	.594	.812	.473	.493	.825	.431	.449	.380
10	71-570122-XXX	.719	.938	.590	.493	.825	.431	.573	.380
12	71-570123-XXX	.812	1.031	.750	.493	.825	.431	.699	.380
14	71-570124-XXX	.906	1.125	.875	.493	.825	.431	.823	.380
16	71-570125-XXX	.969	1.219	1.000	.493	.825	.431	.949	.380
18	71-570126-XXX	1.062	1.312	1.125	.493	.825	.431	1.073	.380
20	71-570127-XXX	1.156	1.438	1.250	.650	1.076	.556	1.199	.286
22	71-570128-XXX	1.250	1.562	1.375	.650	1.076	.556	1.323	.286
24	71-570129-XXX	1.375	1.688	1.500	.683	1.109	.589	1.449	.253

All dimensions for reference only.

Jam Nut Receptacle (PT07) with PCB Contacts

All lockwire holes are .044 Dia. Min.

Order by applicable part number in chart below; add insert arrangement number. Refer to insert availability on pages 4-11.

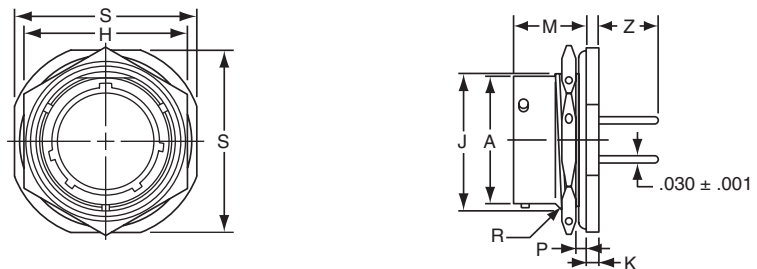

Shell Size	Part Number* PT07 with PCB Contacts	Receptacle Front View		Receptacle Side View							
		H +.017 -.016	S ±.010	A Dia. +.001 -.005	J Flat +.000 -.010	K +.011 -.010	M ±.010	P Panel Thickness		R Thread Class 2A	Z +.025 -.035
		Min.	Max.	Min.	Max.	Min.	Max.	Min.	Max.		
6	71-533720-XXX	.625	.812	.348	.405	.125	.696	.062	.125	.4375-28 UNEF	.376
8	71-533721-XXX	.750	.938	.473	.530	.125	.696	.062	.125	.5625-24 UNEF	.376
10	71-533722-XXX	.875	1.062	.590	.655	.125	.696	.062	.125	.6875-24 UNEF	.376
12	71-533723-XXX	1.062	1.250	.750	.818	.125	.696	.062	.125	.8750-20 UNEF	.376
14	71-533724-XXX	1.188	1.375	.875	.942	.125	.696	.062	.125	1.0000-20 UNEF	.376
16	71-533725-XXX	1.312	1.500	1.000	1.066	.125	.696	.062	.125	1.1250-18 UNEF	.376
18	71-533726-XXX	1.438	1.625	1.125	1.191	.125	.696	.062	.125	1.2500-18 UNEF	.376
20	71-533727-XXX	1.562	1.812	1.250	1.316	.156	.884	.062	.250	1.3750-18 UNEF	.367
22	71-533728-XXX	1.688	1.938	1.375	1.441	.156	.884	.062	.250	1.5000-18 UNEF	.367
24	71-533729-XXX	1.816	2.062	1.500	1.566	.156	.917	.062	.250	1.6250-18 UNEF	.334

All dimensions for reference only.

* For RoHS compliance connectors with PCB contacts change "71"- to:
 "58" designates conductive black zinc cobalt plating
 "93" designates non-conductive black zinc cobalt plating

PTB SPB thru bulkhead receptacle



* PTB-XX-XXX
* SPB-XX-XXX

* To complete part number add desired arrangement number (refer to pages 4 and 5 for insert availability) and add "PS";
Example: PTB-18-32PS. If a rotation is required, use PTB-18-32PS and add W, X, Y or Z. Example: PTB-18-32 PSW.
The socket end of the insert always appears at the "P" dimension end of shell.

■ (MMC) located within .0025 of (TP)

Shell Size	Receptacle Front View				Receptacle Side View					
	R (TP)		S		A +.001 -.005	K +.016 -.000	L ±.005	M +.010 -.000	P Max.	
	PTB	SPB	PTB	SPB					PTB	SPB
6	.469	.641	.688	.953	.348	.625	1.050	.562	.125	.188
8	.594	.734	.812	1.047	.473	.625	1.050	.562	.125	.188
10	.719	.812	.938	1.125	.590	.625	1.050	.562	.125	.188
12	.812	.938	1.031	1.250	.750	.625	1.050	.562	.125	.188
14	.906	1.031	1.125	1.344	.875	.625	1.050	.562	.125	.188
16	.969	1.125	1.219	1.438	1.000	.625	1.050	.562	.125	.188
18	1.062	1.203	1.312	1.516	1.125	.625	1.050	.562	.125	.188
20	1.156	1.297	1.438	1.672	1.250	.781	1.330	.688	.125	.312
22	1.250	1.375	1.562	1.750	1.375	.781	1.330	.688	.125	.312
24	1.375	1.500	1.688	1.875	1.500	.781	1.330	.688	.125	.312

All dimensions for reference only.

PT hermetic

**solder
mounting
receptacle**



**box
mounting
receptacle**



**jam nut
receptacle**



Three shell styles are available in the hermetic PT bayonet series:

- PTIH (MS3113H)
- PT02H
- PT07H (MS3114H)

These hermetic connectors are only available with solder cup or flat eyelet pin contacts in the MS/PT version. Socket contacts are available in some proprietary PT versions. Other design characteristics of the PT hermetic connector series are as follows:

Shell sizes: 8 through 24 (tin plated)

Contact count: 2 through 61. Refer to pages 4 and 5 for insert availability for hermetics.

Current: 5.0 amp each #20 contact
10 amp each #16 contact
17 amp each #12 contact

Contacts are tin plated for PT; gold is optional

Dielectric Withstanding Voltage (sea level):
1500 volts (RMS) 60 cps, Service Rating I
2300 volts (RMS) 60 cps, Service Rating II

Compression glass inserts, permanently lettered

Helium Leakage: Less than 1.0×10^{-6} cc/sec.
at 15 psi differential

Physical Shock: 100 G's

Vibration: Exceeds MIL-E-5272 Procedure II

Thermal Shock: No deterioration or failure after 5 cycles
at -55°F to $+257^{\circ}\text{F}$

Intermateability: Mates with MS3116 and PT06

Refer to pages 4-11 for insert arrangement availability.

PTIH (MS3113H)

hermetic solder mounting receptacle



- * PTIH-XX-XXX
- ** PTIY-XX-XXX
- ** MS3113H-XXCXXX
- † PTIH-XX-XXX (100)
- †† PTIY-XX-XXX (100)
- †† MS3113H-XXYXXX

To complete part number see how to order on page 27.

- * Solder cup pin contacts without interfacial seal
- ** Solder cup pin contacts with interfacial seal
- † Flat eyelet pin contacts without interfacial seal
- †† Flat eyelet pin contacts with interfacial seal

Shell Size	Recept. Front View	Receptacle Side View				
	G Dia. Max.	A Dia. +.001 - .005	L +.025 - .016	N Dia. +.001 - .005	W +.011 - .010	Z Max.
6	.511	.348	.447	.438	.094	.386
8	.636	.473	.447	.562	.094	.386
10	.761	.590	.447	.672	.094	.386
12	.855	.750	.447	.781	.094	.386
14	.980	.875	.447	.906	.094	.386
16	1.105	1.000	.447	1.031	.094	.386
18	1.229	1.125	.447	1.156	.094	.386
20	1.323	1.250	.509	1.250	.094	.386
22	1.449	1.375	.509	1.375	.125	.418
24	1.574	1.500	.542	1.500	.125	.418

All dimensions for reference only.

PT02H

hermetic box mounting receptacle

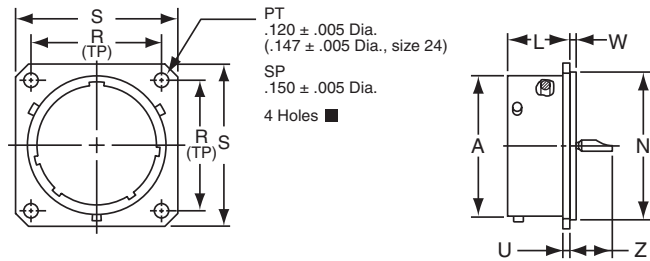

- * PT02H-XX-XXX
- ** PT02Y-XX-XXX
- † PT02H-XX-XXX (100)
- †† PT02Y-XX-XXX (100)

To complete part number see how to order on page 27.

* Solder cup pin contacts without interfacial seal

** Solder cup pin contacts with interfacial seal

† Flat eyelet pin contacts without interfacial seal

†† Flat eyelet pin contacts with interfacial seal

■ (MMC) located within .0025 of (TP)

Shell Size	Receptacle Front View		Receptacle Side View					
	R (TP)	S ±.016	A Dia. +.001 -0.005	K ±.015	L +.025 -0.015	N Dia. +.001 -0.005	U +.011 -0.010	Z Max.
6	.469	.688	.348	.047	.494	.438	.062	.344
8	.594	.812	.473	.047	.494	.562	.062	.344
10	.719	.938	.590	.047	.494	.672	.062	.344
12	.812	1.031	.750	.047	.494	.781	.062	.344
14	.906	1.125	.875	.047	.494	.906	.062	.344
16	.969	1.219	1.000	.047	.494	1.031	.062	.344
18	1.062	1.312	1.125	.047	.494	1.156	.062	.344
20	1.156	1.438	1.250	.047	.556	1.250	.062	.344
22	1.250	1.562	1.375	.079	.556	1.375	.062	.377
24	1.375	1.688	1.500	.079	.588	1.500	.062	.377

All dimensions for reference only.

PT07H (MS3114H)

hermetic jam nut receptacle

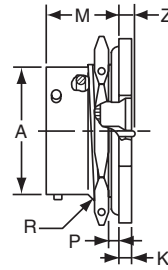

- * PT07H-XX-XXX
- ** PT07Y-XX-XXX
- ** MS3114H-XXCXXX
- † PT07H-XX-XXX (100)
- †† PT07Y-XX-XXX (100)
- †† MS3114H-XXYXXX

To complete part number see how to order on page 27.

- * Solder cup pin contacts without interfacial seal
- ** Solder cup pin contacts with interfacial seal
- † Flat eyelet pin contacts without interfacial seal
- †† Flat eyelet pin contacts with interfacial seal

Shell Size	Receptacle Front View		Receptacle Side View						
	S +.016	H Hex +.017 -.016	A +.001 -.005	K +.043 -.016	M +.031 -.000	P Panel Thickness		R Thread Class 2A	Z Max.
						Max.	Min.		
6	.812	.625	.348	.094	.696	.125	.062	.4375-28 UNEF	.206
8	.938	.750	.473	.094	.696	.125	.062	.5625-24 NEF	.206
10	1.062	.875	.590	.094	.696	.125	.062	.6875-24 NEF	.206
12	1.250	1.062	.750	.094	.696	.125	.062	.8750-20 UNEF	.206
14	1.375	1.188	.875	.094	.696	.125	.062	1.0000-20 UNEF	.206
16	1.500	1.312	1.000	.094	.696	.125	.062	1.1250-18 NEF	.206
18	1.625	1.438	1.125	.094	.696	.125	.062	1.2500-18 NEF	.206
20	1.812	1.562	1.250	.125	.884	.250	.062	1.3750-18 NEF	.081
22	1.938	1.688	1.375	.125	.884	.250	.062	1.5000-18 NEF	.081
24	2.062	1.812	1.500	.125	.917	.250	.062	1.6250-18 NEF	.048

All dimensions for reference only.

PT Breakaway twist pull plug

The PT miniature breakaway connector has the following design features:

- solder contacts, potted termination
- instant decoupling of plug and receptacle with an axial pull on the lanyard when they are fully mated
- intermateable with standard receptacles
- operating voltage to 900 VAC (RMS) at sea level
- same quick positive bayonet coupling and 5 key/keyway polarization as other PT styles

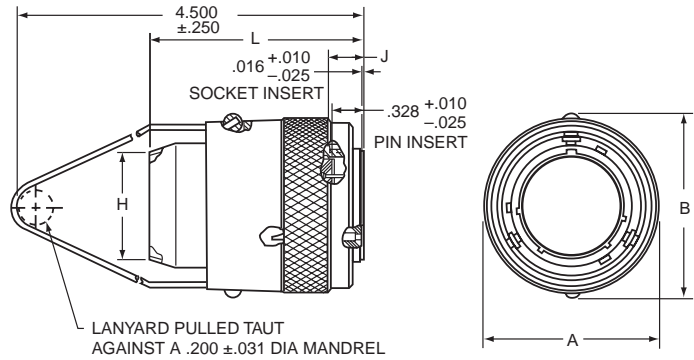

**Breakaway Plug
with PT Solder Contacts,
Potted Termination**
71-3048XX-()
72-3048XX-()

Part Number*	Shell Size	A Dia. Max.	B Max.	H ±.016	J ±.010	L Max.
71-304808	8	.875	.984	.327	.353	1.937
71-304810	10	1.125	1.125	.444	.353	1.890
71-304812	12	1.281	1.406	.558	.353	1.906
71-304814	14	1.438	1.562	.683	.353	1.953
71-304816	16	1.562	1.688	.808	.353	2.000
71-304818	18	1.718	1.844	.909	.353	2.031
71-304820	20	1.875	2.000	1.034	.415	2.234
71-304822	22	2.031	2.188	1.159	.415	2.328
71-304824	24	2.156	2.312	1.284	.415	2.359

All dimensions for reference only.

* See Finish information below to determine prefix 71 or 72 in part number.

Drawing above shows standard lanyard length.

Order by Amphenol Propriety number as follows (example part number shown):

71 - 3048 18 - 32 P
1 2 3 4

1. Finish

"71" designates corrosion resistant olive drab cadmium plate

"72" designates anodic coated (electrically nonconductive-anodic) finish providing extreme wear and corrosion resistance, 500 hour extended salt spray.

2. Connector Type Identification

3048 designates PT plug, solder, potted termination style

3. Shell Size and Insert Arrangement Number

See insert arrangement availability for Miniature Breakaway connectors on page 6. The numbers in the insert arrangement are hyphenated. The number preceding the hyphen is the shell size. The number following the hyphen is the insert arrangement number.

4. Contact Type/Alternate Insert Rotation

P designates pin, S designates socket for normal positioning of inserts. When an alternate position of the insert is required to prevent cross-mating a different letter (other than P or S) is used. See page 7 for description of alternate positions; then convert to Amphenol proprietary coding by the chart at right to complete the part number.

Pin Contacts		Socket Contacts	
Amphenol Letter	Equates to MS letter	Amphenol Letter	Equates to MS letter
G	PW	H	SW
I	PX	J	SX
K	PY	L	SY
M	PZ	N	SZ

PT, SP, MS/PT

how to order

PT, SP

To more easily illustrate ordering procedure, part number PT00A-20-41PW(SR) is shown as follows:

PT	00	A	-	20	-	41	P	W	(SR)
1	2	3	4	5	6	7	8		

See code below:

- Connector Type
 - "PT" designates standard olive drab, electrically conductive cadmium plate bayonet lock connector with solder contacts
 - "SP" designates electrically non-conductive, hard anodic coated bayonet lock connector with solder contacts and larger flange and mounting holes for back panel mounting
 - "PTG" designates plug with grounding fingers
- Shell Style
 - "00" designates wall mounting receptacle
 - "01" designates cable connecting receptacle**
 - "02" designates box mounting receptacle
 - "06" designates straight plug
 - "07" designates jam nut receptacle
 - "08" designates 90 degree plug cable support
 - "B" designates thru bulkhead receptacle (pressurized)
 - "I" designates solder mount receptacle (Hermetic only)
- Service Classes
 - "A" designates general duty back shell
 - "C" designates pressurized receptacle
 - "E" designates environmental resisting open wire seal with grommet and nut
 - "J" designates clamp assembly for moisture proofing multi-jacketed cables, with strain relief
 - "P" designates assembly with potting boot
 - "W" designates clamp assembly for moisture proofing multi-jacketed cables
 - "H" designates hermetic* without interfacial seal
 - "Y" designates hermetic* with interfacial seal
- Shell Size
 - "20" designates shell size. Shell sizes 6 through 24 available.
- Insert Arrangement - Refer to pages 4-11 for insert availability.
 - "20 - 41" designates insert arrangement. (The number following the hyphen is the number only that is used in the part number).
- Contacts
 - "P" designates pin contacts
 - "S" designates socket contacts

For ordering connectors with printed circuit board contacts, see pg. 20.
- Insert Rotation - Refer to page 7.
 - "W", "X", "Y", "Z" designate that insert is rotated in its shell from "normal position. No letter required for normal (no rotation) position.
- "SR" designates a strain relief clamp.
 - Indicate optional finishes as follows:
 - (003) olive drab cadmium plate (standard on "PT")
 - (005) anodic coating - Alumilite® (standard on "SP")
 - (014) olive drab cadmium plate over nickel
 - (023) electroless nickel
 - (024) olive drab zinc cobalt plating
 - (424) electroless nickel finish with strain relief
 - (466) olive drab zinc cobalt plating with strain relief
 - (100) Suffix added for flat eyelet pin contacts in hermetic versions
 - OR
 - RoHS Compliant finish suffix as follow:
 - (025) non-conductive black zinc cobalt plating
 - (027) conductive black zinc cobalt plating
 - (470) non-conductive black zinc cobalt plating with strain relief
 - (476) conductive black zinc cobalt plating with strain relief



MS/PT

MIL-C-26482, Series 1

Part number MS3110E20-41PW is shown as follows:

MS	311	0	E	20	-	41	P	W
1	2	3	4	5	6	7	8	

For Hermetic connectors part number MS3113H20Y41PW is shown as follows:

MS	311	3	H	20	Y	41	P	W
1	2	3	4	5, 6	7	8		

See code below:

- "MS" designates Military Standard
- Specification Number
 - "311" designates basic family number for MIL-C-26482, Series 1 solder type
- Shell Style
 - "0" designates wall mounting receptacle
 - "1" designates cable connecting receptacle**
 - "2" designates box mounting receptacle
 - "3" designates solder mount receptacle (hermetic only)
 - "4" designates jam nut receptacle
 - "6" designates straight plug
- Service Class
 - "E" designates environmental resisting connector
 - "F" designates environmental resisting connectors with strain relief
 - "J" designates clamp assembly for moisture proofing multi-jacketed cables, with strain relief
 - "P" designates potted type with potting boot
 - "H" designates hermetic
- Shell Size
 - "20" designates shell size. Shell sizes 8 through 24 available.
- Insert Arrangement - Refer to pages 4-11 for insert availability.
 - "20 - 41" designates arrangement. (The number following the hyphen is the number only that is used in the part number).
 - Hermetic version
 - "20Y41" designates insert arrangement; specify "Y" for flat eyelet pin contacts, or "C" for solder cup pin contacts
- Contact Configuration
 - "P" designates pin contacts
 - "S" designates socket contacts
- Insert Rotation- Refer to page 7.
 - "W", "X", "Y", "Z" designate that insert is rotated in it shell from "normal" position. No letter require fo normal (no rotation) position.

* Hermetic connectors are supplied with tin plated shells.

** This connector style is sometimes referred to as a cable connecting "plug". It does, however, mate with either a straight or 90 degree plug.

For ordering Miniature Breakaway PT Solder connectors see pg. 26.

HOW TO ORDER
PT, SP, MS/PT

Amphenol® PT-SE, SP-SE, MS/PT-SE

Proprietary/MIL-C-26482, Series 1

bayonet coupling and crimp termination

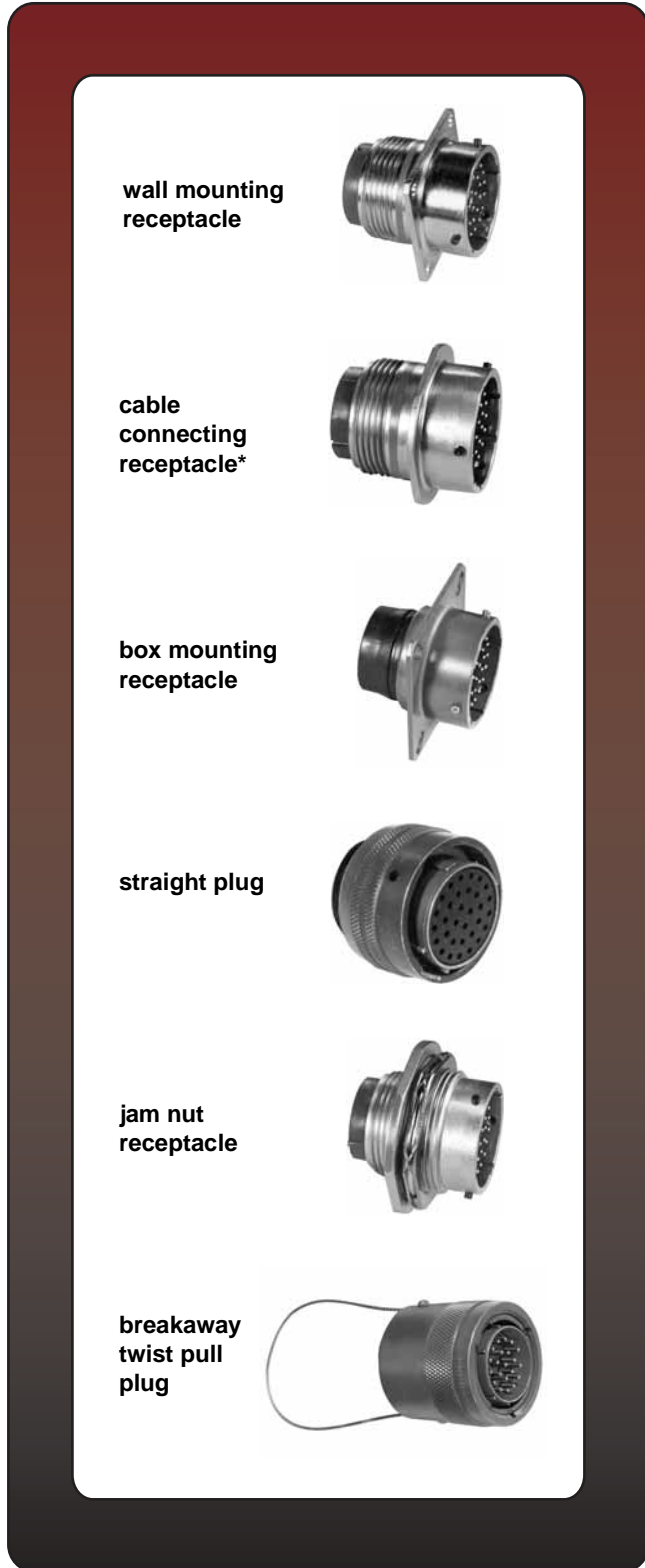

Amphenol® SE crimp type miniature connectors provide performance and versatility needed for applications demanding high reliability and crimp removable contacts. These crimp contacts are rear insertable/front release and are held in position by an MS approved spring tower retention system.

The MS/PT-SE Series is qualified to MIL-C-26482, Series 1 and has all the outstanding design characteristics and quality of the PT Series.

The SP-SE Series is a modification of the PT-SE, providing special shells with a wide mounting flange for back panel mounting.

A corrosion resistant electrically conductive finish of cadmium plate with an olive drab chromate after-treatment is used on the PT-SE and MS/PT-SE. The SP-SE is given a durable non-conductive hard anodic "Alumilite"® coating which provides abrasion protection and resistance to corrosion.

Shell components for these series are aluminum. The dependable 5 key/keyway polarization with bayonet lock coupling assures positive mating with no chance of cross plugging. Spring tension provided by a wave washer in the coupling nut ensures maintenance of interfacial seal between mating halves.

Both the insert and main joint gasket are molded from resilient neoprene. This provides excellent moisture sealing at the gasket and superior electrical isolation of the contact in the insert. Both pins and sockets are machined from a copper alloy and are gold plated. This gold plating eliminates contact corrosion and offers an indefinite shelf life. Socket contacts for these series are a closed entry design.

Breakaway style plug is available in PT-SE crimp.

The PT-SE, SP-SE and MS/PT-SE Series are intermateable and intermountable with all existing Miniature Cylindrical Series connectors except for the threaded coupling PC Series.

Refer to pages 4-11 for insert arrangement availability.

* This connector style is sometimes referred to as a cable connecting "plug". It does, however, mate with either a straight or 90 degree plug.

PT-SE, SP-SE, MS/PT-SE

Contact Specifications				
Contact Size	Test Current	Maximum Millivolt Drop†	Crimp Well Diameter	Minimum Well Depth
20	7.5	55	.049 ±.001	.267
16	13.0	49	.067 ±.001	.236
12	23.0	42	.100 ±.002	.236

Service Rating					
Service Rating	Recommended Operating AC Voltage at Sea Level	Test Voltage AC (RMS), 60 cps			
		Sea Level	50,000 ft.	70,000 ft.	110,000 ft.
I	600	1,500	500	375	200
II	1,000	2,300	750	500	200

† Silver plated wire per MIL-C-26482

PT-SE and SP-SE Service Classes

PT-SE and SP-SE connectors are available in the three service classes listed below.

- “SE” Open wire sealing - environmental resistant, with a nut and grommet for moisture proofing individual wires
- “SE” (SR) Strain relief clamp - environmental resistant strain relief clamp and grommet for moisture proofing individual wires; provides added wire bundle support
- “SP” Translucent nylon boot for retaining customer applied potting compounds; held in place by a threaded ring

Breakaway style - see page 38.

MS/PT-SE Service Classes

MS-SE series connectors are available in the following certified service classes:

- “E” Open wire sealing - environmental resisting connectors are supplied with a multi-hole grommet and clamping nut for moisture proofing individual open wires
- “F” Environmental resistant strain relief clamp and grommet for moisture proofing individual wires; provides added wire bundle support
- “P” Potting applications - these connectors are supplied with a translucent nylon boot for retention of customer applied potting compound



BAYONET COUPLING WITH CRIMP CONTACTS
PT-SE, SP-SE, MS/PT-SE

PT00 SE (MS3120) SP00 SE wall mounting receptacle



“SE” Open Wire Seal



PT00SE-XX-XXX
SP00SE-XX-XXX
MS3120E-XX-XXX

TERMINATION ASSEMBLIES
“SE” (SR), MS / “F” Strain Relief



PT00SE-XX-XXX (SR)
SP00SE-XX-XXX (SR)
MS3120F-XX-XXX

“SP” Potting Boot



PT00SP-XX-XXX
SP00SP-XX-XXX

To complete part number see how to order on page 39.
■ (MMC) located within .005 of (TP)

Shell Size	Receptacle Front View						Receptacle Side View					
	R (TP)		S Max.		T Dia. ± .005		A Dia. +.001 - .005	K ± .016	M +.010 - .000		P* Max. Panel Thickness	
	PT	SP	PT	SP	PT	SP			PT	SP	PT	SP
8	.594	-	.828	-	.120	-	.473	.062	.431	-	.094	-
10	.719	.812	.954	1.141	.120	.150	.590	.062	.431	.462	.094	.125
12	.812	.938	1.047	1.266	.120	.150	.750	.062	.431	.462	.094	.125
14	.906	1.031	1.141	1.360	.120	.150	.875	.062	.431	.462	.094	.125
16	.969	1.125	1.234	1.453	.120	.150	1.000	.062	.431	.462	.094	.125
18	1.062	1.203	1.328	1.532	.120	.150	1.125	.062	.431	.462	.094	.125
20	1.156	1.297	1.453	1.688	.120	.150	1.250	.094	.556	.556	.219	.219
22	1.250	1.375	1.578	1.766	.120	.150	1.375	.094	.556	.556	.219	.219
24	1.375	1.500	1.703	1.891	.147	.150	1.500	.094	.589	.589	.219	.219

Shell Size	Class “SE”, MS / “E”		Class “SE” (SR), MS / “F”			Class “SP”, MS / “P”		
	L Max.	N Dia. Max.	G Dia.	L Max.	N Max.	D Dia. Max.	L Max.	N Dia. Max.
8	1.328	.560	.125	2.422	.781	-	-	-
10	1.328	.704	.188	2.422	.844	.444	1.656	.734
12	1.328	.825	.312	2.422	.969	.558	1.656	.858
14	1.328	.954	.375	2.422	1.094	.683	1.656	.984
16	1.328	1.080	.500	2.537	1.156	.808	1.656	1.110
18	1.328	1.204	.625	2.537	1.406	.909	1.656	1.234
20	1.359	1.330	.625	2.824	1.406	1.034	1.750	1.360
22	1.359	1.454	.750	2.824	1.594	1.159	1.750	1.484
24	1.422	1.580	.800	2.900	1.688	1.284	1.782	1.610

* Back panel mounting
All dimensions for reference only.

MF00 SE (MS3128)

wall mounting receptacle



TERMINATION ASSEMBLIES

MS / "E" Open Wire Seal



MF00SE-XX-XXX
MS3128E-XX-XXX

MS / "F" Strain Relief



MF00SE-XX-XXX (SR)
MS3128F-XX-XXX

To complete part number see how to order on page 39.
 ■ (MMC) located within .0025 of (TP)

Shell Size	Receptacle Front View					Receptacle Side View									
	R	R ¹	S Max.	T Dia. ±.005	T ¹ Dia. ±.005	A Dia. +.001 - .005	K ±.016	M +.010 - .000	Class MS / "E"		Class MS / "F"				
									L Max.	N Max.	F Min.	G Dia.	L Max.	N Max.	
10	.719	.812	1.141	.120	.150	.590	.062	.462	1.328	.685	.297	.188	1.906	.891	
12	.812	.938	1.266	.120	.150	.750	.062	.462	1.328	.813	.422	.312	1.906	1.016	
14	.906	1.031	1.360	.120	.150	.875	.062	.462	1.328	.930	.547	.375	1.906	1.141	
16	.969	1.125	1.453	.120	.150	1.000	.062	.462	1.328	1.057	.609	.500	2.000	1.203	
18	1.062	1.203	1.532	.120	.150	1.125	.062	.462	1.328	1.175	.734	.625	2.000	1.469	
20	1.156	1.297	1.688	.120	.150	1.250	.094	.556	1.359	1.301	.734	.625	2.172	1.469	
22	1.250	1.375	1.766	.120	.150	1.375	.094	.556	1.359	1.428	.922	.750	2.172	1.656	
24	1.375	1.500	1.891	.147	.150	1.500	.094	.589	1.422	1.533	.984	.800	2.234	1.750	

All dimensions for reference only.

PT01 SE (MS3121) SP01 SE cable connecting receptacle



"SE", MS / "E" Open Wire Seal



PT01SE-XX-XXX
SP01SE-XX-XXX
MS3121E-XX-XXX

TERMINATION ASSEMBLIES
"SE" (SR), MS / "F" Strain Relief



PT01SE-XX-XXX (SR)
SP01SE-XX-XXX (SR)
MS3121F-XX-XXX

"SP", MS / "P" Potting Boot



PT01SP-XX-XXX
SP01SP-XX-XXX
MS3121P-XX-XXX

Note: This connector style is sometimes referred to as a cable connecting "plug".
It does, however, mate with either a straight or 90 degree plug.
To complete part number see how to order on page 39.

Shell Size	Receptacle Front View		Receptacle Side View								
	S Max.	A Dia. +.001 -.005	Class "SE", MS / "E"			Class "SE" (SR), MS / "F"			Class "SP", MS / "P"		
			K ±.018	L Max.	N Dia. Max.	G Dia.	L Max.	N Max.	D Dia.	L Max.	N Dia. Max.
8	.812	.473	.094	1.522	.560	.125	2.422	.828	—	—	—
10	.955	.590	.094	1.522	.685	.188	2.422	.891	.444	1.656	.734
12	1.048	.750	.094	1.522	.813	.312	2.422	1.016	.558	1.656	.858
14	1.142	.875	.094	1.522	.930	.375	2.422	1.141	.683	1.656	.984
16	1.236	1.000	.094	1.522	1.057	.500	2.537	1.203	.808	1.656	1.110
18	1.329	1.125	.094	1.522	1.175	.625	2.537	1.469	.909	1.656	1.234
20	1.455	1.250	.115	1.709	1.301	.625	2.824	1.469	1.034	1.750	1.360
22	1.579	1.375	.115	1.709	1.428	.750	2.824	1.656	1.159	1.750	1.484
24	1.709	1.500	.115	1.709	1.555	.800	2.900	1.750	1.284	1.782	1.610

All dimensions for reference only.

PT02 SE (MS3122) SP02 SE box mounting receptacle

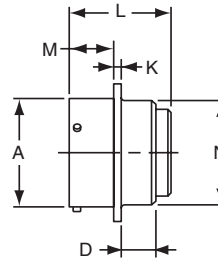
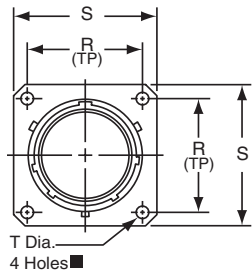

PT02SE-XX-XXX
SP02SE-XX-XXX
MS3122E-XX-XXX

To complete part number see how to order on page 39.
■ (MMC) located within .0025 of (TP)

Shell Size	Receptacle Front View						Receptacle Side View							
	R		S Max.		T Dia. ±.005		A Dia. +.001 - .005	D Max.		K ±.016	L Max.	M +.010 - .000		N Dia. +.011 - .000
	PT	SP	PT	SP	PT	SP		PT	SP			PT	SP	
8	.594	-	.828	-	.120	-	.473	.312	-	.062	1.296	.431	-	.438
10	.719	.812	.954	1.141	.120	.150	.590	.312	.219	.062	1.296	.431	.462	.562
12	.812	.938	1.047	1.266	.120	.150	.750	.312	.219	.062	1.296	.431	.462	.688
14	.906	1.031	1.141	1.360	.120	.150	.875	.312	.219	.062	1.296	.431	.462	.812
16	.969	1.125	1.234	1.453	.120	.150	1.000	.312	.219	.062	1.296	.431	.462	.938
18	1.062	1.203	1.328	1.532	.120	.150	1.125	.312	.219	.062	1.296	.431	.462	1.062
20	1.156	1.297	1.453	1.688	.120	.150	1.250	.406	.344	.094	1.358	.556	.556	1.188
22	1.250	1.375	1.578	1.766	.120	.150	1.375	.406	.344	.094	1.358	.556	.556	1.312
24	1.375	1.500	1.703	1.891	.147	.150	1.500	.406	.344	.094	1.358	.589	.589	1.438

All dimensions for reference only.

MF02 SE (MS3127)

box mounting receptacle

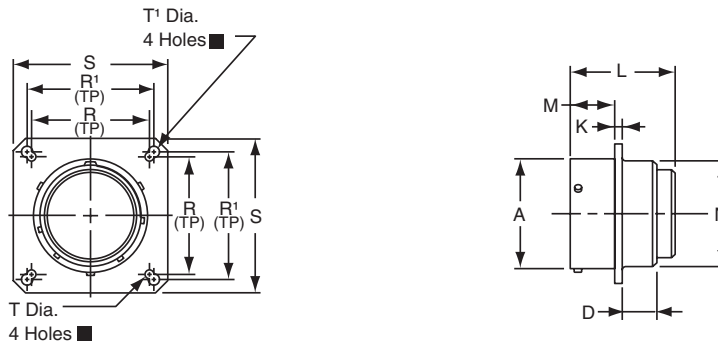

MF02SE-XX-XXX
MS3127E-XX-XXX

To complete part number see how to order on page 39.

■ (MMC) located within .0025 of (TP)

Shell Size	Receptacle Front View						Receptacle Side View				
	N Dia. +.011 -0.000	R	R ¹	S Max.	T ±.005	T ¹ ±.005	A Dia. +.001 -0.005	D Max.	K ±.016	L Max.	M +.010 -0.000
10	.562	.719	.812	1.141	.120	.150	.590	.219	.062	1.266	.462
12	.688	.812	.938	1.266	.120	.150	.750	.219	.062	1.266	.462
14	.812	.906	1.031	1.360	.120	.150	.875	.219	.062	1.266	.462
16	.938	.969	1.125	1.453	.120	.150	1.000	.219	.062	1.266	.462
18	1.062	1.062	1.203	1.532	.120	.150	1.125	.219	.062	1.266	.462
20	1.188	1.156	1.297	1.688	.120	.150	1.250	.344	.094	1.328	.556
22	1.312	1.250	1.375	1.766	.120	.150	1.375	.344	.094	1.328	.556
24	1.438	1.375	1.500	1.891	.147	.150	1.500	.344	.094	1.328	.589

All dimensions for reference only.

PT06 SE (MS3126) SP06 SE straight plug



“SE”, MS / “E” Open Wire Seal

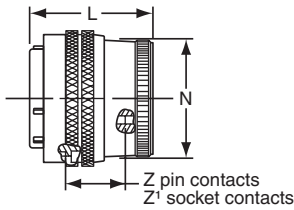

PT06SE-XX-XXX
SP06SE-XX-XXX
PTG06SE-XX-XXX
MS3126E-XX-XXX

TERMINATION ASSEMBLIES
“SE” (SR), MS / “F” Strain Relief

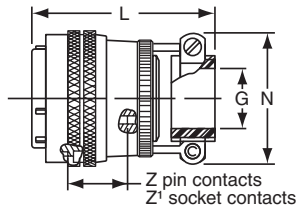

PT06SE-XX-XXX (SR)
SP06SE-XX-XXX (SR)
PTG06SE-XX-XXX (SR)
MS3126F-XX-XXX

“SP”, MS / “P” Potting Boot

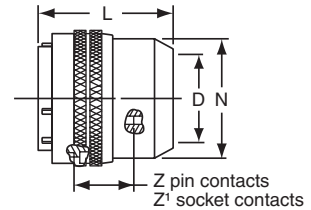

PT06SP-XX-XXX
SP06SP-XX-XXX
PTG06SP-XX-XXX
MS3126P-XX-XXX

To complete part number see how to order on page 39.

Shell Size	Plug Front View		Plug Side View								
	S Dia. Max.	Z ±.045	Z' ±.045	Class “SE”, MS / “E”		Class “SE” (SR), MS / “F”			Class “SP”, MS / “P”		
				L Max.	N Max.	G Dia.	L Max.	N Max.	D Dia.	L Max.	N Dia. Max.
8*	.734	.640	.579	1.328	.540	.125	2.413	.828	.327	1.750	.578
10	.859	.640	.579	1.328	.685	.188	2.413	.891	.444	1.750	.734
12	1.031	.640	.579	1.328	.813	.312	2.413	1.016	.558	1.750	.858
14	1.156	.640	.579	1.328	.930	.375	2.413	1.141	.683	1.750	.984
16	1.281	.640	.579	1.328	1.057	.500	2.528	1.203	.808	1.750	1.110
18	1.391	.640	.579	1.328	1.175	.625	2.528	1.469	.909	1.750	1.234
20	1.531	.640	.579	1.297	1.301	.625	2.753	1.469	1.034	1.750	1.360
22	1.656	.640	.579	1.297	1.428	.750	2.753	1.656	1.159	1.750	1.484
24	1.777	.640	.579	1.359	1.533	.800	2.830	1.750	1.284	1.766	1.610

* PT-SE, MS-SE and MS-SP only.
All dimensions for reference only.

PT07 SE (MS3124) SP07 SE jam nut receptacle

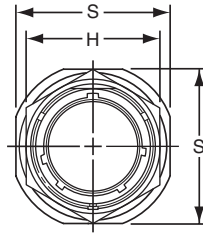

TERMINATION ASSEMBLIES
"SE" (SR), MS / "F" Strain Relief

"SE", MS / "E" Open Wire Seal

"SP", MS / "P" Potting Boot



PT07SE-XX-XXX
SP07SE-XX-XXX
MS3124E-XX-XXX

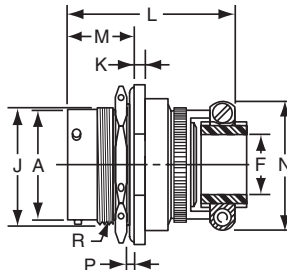

PT07SE-XX-XXX (SR)
SP07SE-XX-XXX (SR)
MS3124F-XX-XXX

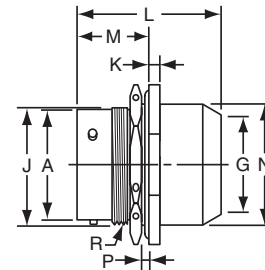

PT07SP-XX-XXX
SP07SP-XX-XXX
MS3124P-XX-XXX

To complete part number see how to order on page 39.
All lockwire holes are .044 Dia. Min.

Shell Size	Receptacle Front View		Receptacle Side View						
	H Hex Max.	S Max.	A Dia. +.001 -0.005	J Flat +.000 -0.010	K +.011 -0.010	M ±.005	P Panel Thickness		R Thread Class 2A
							Min.	Max.	
8	.767	.954	.473	.530	.125	.696	.062	.125	.5625-24 UNEF
10	.892	1.078	.590	.655	.125	.696	.062	.125	.6875-24 NEF
12	1.079	1.266	.750	.818	.125	.696	.062	.125	.8750-20 UNEF
14	1.205	1.391	.875	.942	.125	.696	.062	.125	1.0000-20 UNEF
16	1.329	1.516	1.000	1.066	.125	.696	.062	.125	1.1250-18 NEF
18	1.455	1.641	1.125	1.191	.125	.696	.062	.125	1.2500-18 NEF
20	1.579	1.828	1.250	1.316	.156	.884	.062	.250	1.3750-18 NEF
22	1.705	1.954	1.375	1.441	.156	.884	.062	.250	1.5000-18 NEF
24	1.829	2.078	1.500	1.566	.156	.917	.062	.250	1.6250-18 NEF

Shell Size	Class "SE", MS / "E"		Class "SE" (SR), MS / "F"				Class "SP", MS / "P"		
	L Max.	N Max.	F Min.	G Dia. Free	L Max.	N Max.	G Dia.	L Max.	N Dia. Max.
8	1.438	.749	.234	.125	1.922	.828	-	-	-
10	1.438	.874	.297	.188	1.922	.891	.444	1.656	.734
12	1.438	.999	.422	.312	1.922	1.016	.558	1.656	.858
14	1.438	1.124	.547	.375	1.922	1.141	.683	1.656	.984
16	1.438	1.249	.609	.500	2.000	1.203	.808	1.656	1.110
18	1.438	1.374	.734	.625	2.000	1.469	.909	1.656	1.234
20	1.625	1.530	.734	.625	2.172	1.469	1.034	1.922	1.360
22	1.625	1.655	.922	.750	2.172	1.656	1.159	1.922	1.484
24	1.688	1.780	.984	.800	2.234	1.750	1.284	1.951	1.610

All dimensions for reference only.

PT08 SE SP08 SE 90 degree plug



TERMINATION ASSEMBLIES

“SE” Open Wire Seal, “SE” (SR) Strain Relief



PT08SE-XX-XXX
SP08SE-XX-XXX
PT08SE-XX-XXX (SR)
SP08SE-XX-XXX (SR)

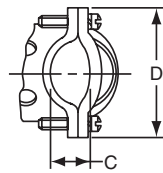

“SP” Potting Boot 75 degrees



PT08SP-XX-XXX
SP08SP-XX-XXX

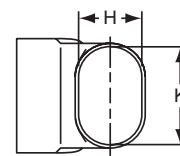

To complete part number see how to order on page 39.
All lockwire holes are .044 Dia. Min.

Shell Size	Plug Front View	Plug Side View								
	G Dia. Max.	Class “SE”, “SE” (SR)					Class “SP”			
		B ±.031	C +.010 - .025	D ±.062	E +.047 - .025	L Max.	A ±.025	H ±.015	K ±.015	L Max.
10	.921	.749	.170	1.191	.393	2.137	.547	.438	.562	2.031
12	1.046	.812	.264	1.191	.450	2.222	.625	.516	.688	2.093
14	1.171	.905	.310	1.254	.519	2.370	.734	.625	.781	2.203
16	1.297	1.030	.330	1.316	.583	2.572	.750	.656	.890	2.250
18	1.422	1.015	.444	1.562	.621	2.680	.781	.703	1.000	2.296
20	1.562	1.077	.510	1.625	.683	2.753	.859	.766	1.125	2.343
22	1.672	1.139	.515	1.719	.739	2.799	.906	.812	1.234	2.390
24	1.797	1.250	.656	1.750	.787	3.037	1.181	.918	1.374	2.624

All dimensions for reference only.

PT-SE Breakaway

twist pull plug

The PT-SE miniature breakaway connector has the following design features:

- crimp front release, front removable contacts in "SE" spring tower retention system
- 3 styles available: potted termination, environmental style and environment style with a strain relief
- instant decoupling of plug and receptacle with an axial pull on the lanyard when they are fully mated
- intermateable with standard receptacles
- operating voltage to 900 VAC (RMS) at sea level
- quick positive bayonet coupling and 5 key/keyway polarization



Breakaway PT-SE with Crimp Contacts, Environmental
71-3455XX-()
72-3455XX-()

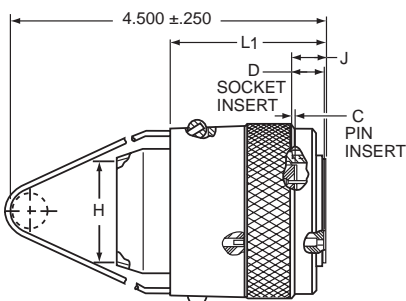

Breakaway PT-SE with Crimp Contacts, Potted Termination
71-4196XX-()
72-4196XX-()

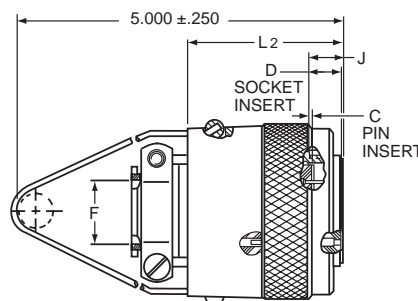

Breakaway PT-SE with Crimp Contacts, Environmental with Strain Relief
71-2511XX-()
72-2511XX-()

Part Number*	Part Number*	Part Number*	Shell Size	A Dia. Max.	B Max.	C +.020 - .000	D +.020 - .000	F Dia. ±.016	H Dia. ±.016	J ±.010	L Max.	L ₁ Max.	L ₂ Max.
71-419646	71-251181	71-345510	10	1.125	1.125	.030	.337	.188	.444	.353	1.875	2.140	2.156
71-419647	71-251182	71-345512	12	1.281	1.406	.030	.337	.312	.558	.353	1.875	2.156	2.406
71-419648	71-251183	71-345514	14	1.438	1.562	.030	.337	.375	.683	.353	1.906	2.203	2.406
71-419649	71-251184	71-345516	16	1.562	1.688	.030	.337	.500	.808	.353	1.969	2.250	2.531
71-419650	71-251185	71-345518	18	1.718	1.844	.030	.337	.625	.909	.353	2.000	2.281	2.531
71-419651	71-251186	71-345520	20	1.875	2.000	.092	.399	.625	1.034	.415	2.281	2.359	2.719
71-419652	71-251187	71-345522	22	2.031	2.188	.092	.399	.750	1.159	.415	2.344	2.453	2.844
71-419653	71-251188	71-345524	24	2.156	2.312	.092	.399	.800	1.284	.415	2.406	2.453	2.906

All dimensions for reference only.

* See Finish information below to determine prefix 71 or 72 in part number.

Drawing above shows standard lanyard length.

Order by Amphenol Proprietary number as follows (example part number shown):

71 - 4196 50 - 32 P
1 2 3 4 5

1. Finish

"71" designates corrosion resistant olive drab cadmium plate

"72" designates anodic coated (electrically nonconductive-anodic) finish providing extreme wear and corrosion resistance, 500 hr. extended salt spray.

2. Connector Type Identification

4196XX designates PT-SE plug, crimp, potted termination style

2511XX designates PT-SE plug, crimp, environmental with strain relief style

3455XX designates PT-SE plug, crimp, environmental

3. Shell Size

See part number columns in chart above for 2 digit number at end that correlates to the shell size. Example: '50' correlates to shell size 18.

4. Insert Arrangement Number

See insert availability for Miniature Breakaway connectors on page 6. The number following the hyphen is the insert arrangement number.

5. Contact Type/Alternate Insert Rotation

P designates pin, S designates socket for normal positioning of inserts. When an alternate position of the insert is required to prevent cross-mating a different letter (other than P or S) is used. See page 7 for description of alternate positions; then convert to Amphenol proprietary coding by the chart at right to complete the part number.

Pin Contacts		Socket Contacts	
Amphenol Letter	Equates to MS letter	Amphenol Letter	Equates to MS letter
G	PW	H	SW
I	PX	J	SX
K	PY	L	SY
M	PZ	N	SZ

PT-SE, SP-SE, MS/PT-SE

how to order

PT-SE, SP-SE

To more easily illustrate ordering procedure, part number PT00SE-20-41PW(SR) is shown as follows:

PT	00	SE	-	20	-	41	P	W	(SR)
1	2	3		4		5	6	7	8

See code below:

1. Connector Type

- "PT" designates standard olive drab, electrically conductive cadmium plated, bayonet lock connector with crimp contacts
- "MF" designates standard olive drab, electrically conductive cadmium plated, bayonet lock connector with dual mounting holes, and crimp contacts
- "SP" designates electrically non-conductive, hard anodic coated, bayonet lock connector with larger flange and mounting holes for back panel mounting, and crimp contacts
- "PTG" designates plug with grounding fingers

2. Shell Style

- "00" designates wall mounting receptacle
- "01" designates cable connecting receptacle*
- "02" designates box mounting receptacle
- "06" designates straight plug
- "07" designates jam nut receptacle
- "08" designates 90 degree plug

3. Service Classes

- "SE" designates environmental crimp
- "SP" designates potted type crimp

Both of the above are Amphenol proprietary versions of the MIL-C-26482, Series 1 crimp contact connector and offer 15 lbs. contact retention for size 20 contacts; 25 lbs. for size 16 contacts.

4. Shell Size

"20" designates shell size. Shell sizes 8 through 24 available.

5. Insert Arrangement

Refer to pages 4-11 for insert availability.

"20 - 41" designates insert arrangement. (The number following the hyphen is the number only that is used in the part number).

6. Contacts

- "P" designates pin contacts
- "S" designates socket contacts

7. Insert Rotation

Refer to page 7.

"W", "X", "Y", "Z" designate that insert is rotated in its shell from "normal" position. No letter required for normal (no rotation) position.

8. "SR" designates a strain relief clamp.

Indicate optional finishes as follows:

- (003) olive drab cadmium plate (standard on "PT")
 - (005) anodic coating - Aluminite® (standard on "SP")
 - (014) olive drab cadmium plate over nickel
 - (023) electroless nickel
 - (024) olive drab zinc cobalt plating
 - (424) electroless nickel finish with strain relief
 - (466) olive drab zinc cobalt plating with strain relief
- OR

RoHS Compliant finish suffix as follow:

- (025) non-conductive black zinc cobalt plating
- (027) conductive black zinc cobalt plating
- (470) non-conductive black zinc cobalt plating with strain relief
- (476) conductive black zinc cobalt with strain relief



MS/PT-SE

MIL-C-26482, Series 1

To more easily illustrate ordering procedure, part number MS3120E20-41PW is shown as follows:

MS	312	0	E	20	-	41	P	W
1	2	3	4	5	6	7	8	

See code below:

1. "MS" designates Military Standard

2. Specification Number

"312" designates basic family for MIL-C-26482, Series 1 crimp type

3. Shell Style

- "0" designates wall mounting receptacle
- "1" designates cable connecting receptacle*
- "2" designates box mounting receptacle
- "4" designates jam nut receptacle
- "6" designates straight plug
- "7" designates box mounting receptacle with dual mounting holes
- "8" designates wall mounting receptacle with dual mounting holes

4. Service Class

- "E" designates environmental resisting connector
- "F" designates environmental resisting connector with strain relief
- "P" designates potted type with potting boot

5. Shell Size

"20" designates shell size. Shell sizes 8 through 24 available

6. Insert Arrangement

Refer to pages 4-11 for insert availability.

"20 - 41" designates insert arrangement. (The number following the hyphen is the number only that is used in the part number).

7. Contacts

- "P" designates pin contacts
- "S" designates socket contacts

8. Insert Rotation

Refer to page 7.

"W", "X", "Y", "Z" designate that insert is rotated in its shell from the "normal" position. No letter required for normal (no rotation) position.

* This connector style is sometimes referred to as a cable connecting "plug". It does, however, mate with either a straight or 90 degree plug.

For ordering Miniature Breakaway PT-SE Crimp connectors see pg. 38.

Amphenol® PT-CE, SP-CE bayonet coupling, crimp termination



Amphenol® CE crimp type miniature connectors provide performance and versatility needed for applications demanding high reliability and crimp removable contacts. These crimp contacts are rear insertable/front release and are held in position by a nylon wafer retention system.

The SP-CE Series is a modification of the PT-CE, providing special shells with a wide mounting flange for back panel mounting.

A corrosion resistant electrically conductive finish of cadmium plate with an olive drab chromate after-treatment is used on the PT-CE. The SP-CE is given a durable nonconductive hard anodic "Alumilite"® coating which provides abrasion protection and resistance to corrosion.

Shell components for these versions are aluminum. The dependable 5 key/keyway polarization with bayonet lock coupling assures positive mating with no chance of cross plugging. Spring tension provided by a wave washer in the coupling nut ensures maintenance of interfacial seal between mating halves.

Both the insert and main joint gasket are molded from resilient neoprene. This provides excellent moisture sealing at the gasket and superior electrical isolation of the contact in the insert. Both pins and sockets are machined from a copper alloy and are gold plated. This gold plating eliminates contact corrosion and offers an indefinite shelf life. Socket contacts for these series are a closed entry design.

Breakaway style plug is available in PT-CE crimp.

The PT-CE and SP-CE Series are intermateable and intermountable with all existing Miniature Cylindrical Series connectors except for the threaded coupling PC Series.

Refer to pages 4-11 for insert arrangement availability.

* This connector style is sometimes referred to as a cable connecting "plug." It does, however, mate with a straight or 90 degree plug.

PT-CE, SP-CE

Contact Specifications				
Contact Size	Test Current	Maximum Millivolt Drop†	Crimp Well Diameter	Minimum Well Depth
20	7.5	55	.045 ^{+0.002} _{-.001}	.359
16	13.0	49	.063 ^{+0.004} _{-.001}	.234

Service Rating					
Service Rating	Recommended Operating AC Voltage at Sea Level	Test Voltage AC (RMS), 60 cps			
		Sea Level	50,000 ft.	70,000 ft.	110,000 ft.
I	600	1,500	500	375	200
II	1,000	2,300	750	500	200

† Silver plated wire per MIL-C-26482

PT-CE, and SP-CE Service Classes

PT-CE and SP-CE Connectors are available in the three service classes listed below.

“CE” Open wire sealing – environmental resistant, with a nut and grommet for moisture proofing individual wires.

“CE” (SR) Strain relief clamp – environmental resistant strain relief clamp and grommet for moisture proofing individual wires; provides added wire bundle support.

“CP” Translucent nylon boot for retaining customer applied potting compounds; held in place by a threaded ring.

Breakaway style - see page 48.



**BAYONET COUPLING
WITH CRIMP CONTACTS**
PT-CE, SP-CE

PT00 CE SP00 CE

wall mounting receptacle

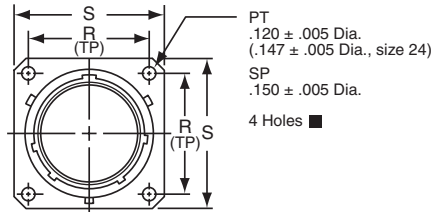

“CE” Open Wire Seal

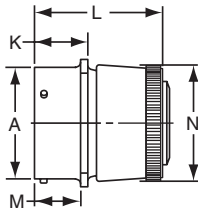

PT00CE-XX-XXX
SP00CE-XX-XXX

TERMINATION ASSEMBLIES
“CE” (SR) Strain Relief

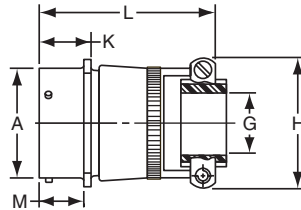

PT00CE-XX-XXX (SR)
SP00CE-XX-XXX (SR)

“CP” Potting Boot

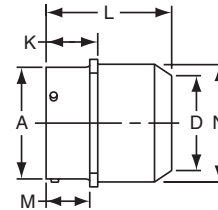

PT00CP-XX-XXX
SP00CP-XX-XXX

To complete part number see how to order on page 49.
■ (MMC) located within .005 Dia. of (TP)

Shell Size	Receptacle Front View				Receptacle Side View													
	R (TP)		S ±.016		A Dia. +.001 -.005	K +.025 -.010		M +.010 -.000		Class “CE”		Class “CE” (SR)			Class “CP”			
	PT	SP	PT	SP		PT	SP	PT	SP	L Max.	N Dia. Max.	G Dia.	H Max.	L Max.	D Dia.	L Max.	N Dia. Max.	
	PT	SP	PT	SP	PT	SP	PT	SP	L Max.	N Dia. Max.	G Dia.	H Max.	L Max.	D Dia.	L Max.	N Dia. Max.		
6	.469	.641	.688	.953	.348	.493	.524	.431	.462	1.468	.440	-	-	-	-	-	-	
8	.594	.734	.812	1.047	.473	.493	.524	.431	.462	1.468	.560	.125	.797	2.031	.327	1.683	.608	
10	.719	.812	.938	1.125	.590	.493	.524	.431	.462	1.468	.685	.188	.859	2.031	.444	1.683	.734	
12	.812	.938	1.031	1.250	.750	.493	.524	.431	.462	1.468	.813	.312	.984	2.031	.558	1.683	.858	
14	.906	1.031	1.125	1.344	.875	.493	.524	.431	.462	1.468	.930	.375	1.109	2.031	.683	1.683	.984	
16	.969	1.125	1.219	1.438	1.000	.493	.524	.431	.462	1.468	1.057	.500	1.172	2.156	.808	1.683	1.110	
18	1.062	1.203	1.312	1.516	1.125	.493	.524	.431	.462	1.468	1.175	.625	1.422	2.156	.909	1.683	1.234	
20	1.156	1.297	1.438	1.672	1.250	.650	.650	.556	.556	1.562	1.301	.625	1.422	2.266	1.034	1.750	1.360	
22	1.250	1.375	1.562	1.750	1.375	.650	.650	.556	.556	1.562	1.428	.750	1.609	2.266	1.159	1.750	1.484	
24	1.375	1.500	1.688	1.875	1.500	.683	.683	.589	.589	1.625	1.555	.800	1.703	2.328	1.284	1.782	1.610	

All dimensions for reference only.

PT01 CE

cable connecting receptacle

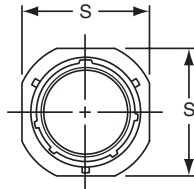

TERMINATION ASSEMBLIES
"CE" (SR) Strain Relief

"CE" Open Wire Seal

"CP" Potting Boot

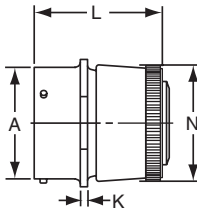

PT01CE-XX-XXX
SP01CE-XX-XXX

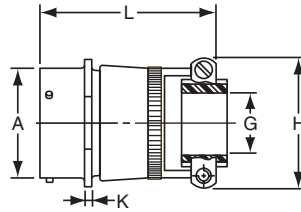

PT01CE-XX-XXX (SR)
SP01CE-XX-XXX (SR)

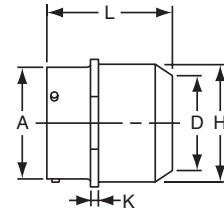

PT01CP-XX-XXX

Note: This connector style is sometimes referred to as a cable connecting "plug". It does, however, mate with either a straight or 90 degree plug.
 To complete part number see how to order on page 49.

Shell Size	Receptacle Front View	Receptacle Side View									
	S ±.016	A Dia. +.001 -.005	K ±.016	Class "CE"		Class "CE" (SR)			Class "CP"		
				L Max.	N Dia.	G Dia.	H Dia.	L Max.	D Dia. Min.	L Max.	N Dia. Max.
6	.688	.348	.094	1.468	.440	-	-	-	-	-	-
8	.812	.473	.094	1.468	.560	.125	.797	1.982	.327	1.702	.608
10	.938	.590	.094	1.468	.685	.188	.859	1.982	.444	1.702	.734
12	1.031	.750	.094	1.468	.813	.312	.984	1.982	.558	1.702	.858
14	1.125	.875	.094	1.468	.930	.375	1.109	1.982	.683	1.702	.984
16	1.219	1.000	.094	1.468	1.057	.500	1.172	2.114	.808	1.702	1.110
18	1.312	1.125	.094	1.468	1.175	.625	1.422	2.114	.909	1.702	1.234
20	1.438	1.250	.115	1.562	1.301	.625	1.422	2.207	1.034	1.796	1.360
22	1.562	1.375	.115	1.562	1.428	.750	1.609	2.207	1.159	1.796	1.484
24	1.688	1.500	.115	1.625	1.555	.800	1.703	2.219	1.284	1.827	1.610

All dimensions for reference only.

PT02 CE SP02 CE box mounting receptacle

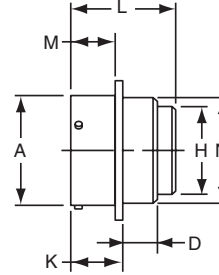
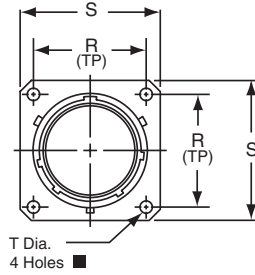

PT02CE-XX-XXX
SP02CE-XX-XXX
PT02CP-XX-XXX
SP02CP-XX-XXX

To complete part number see how to order on page 49.
■ (MMC) located within .005 of (TP)

Shell Size	Receptacle Front View						Receptacle Side View									
	R		S ±.016		T Dia. ±.005		A Dia. +.001 -.005	D		H Dia. Max.	K +.025 -.010		L Max.	M +.010 -.000		N Dia. Max.
	PT	SP	PT	SP	PT	SP		PT	SP		PT	SP		PT	SP	
8	.594	.734	.812	1.047	.120	.150	.473	.344	.312	.317	.493	.524	1.250	.431	.462	.449
10	.719	.812	.938	1.125	.120	.150	.590	.344	.312	.441	.493	.524	1.250	.431	.462	.573
12	.812	.938	1.031	1.250	.120	.150	.750	.344	.312	.566	.493	.524	1.250	.431	.462	.699
14	.906	1.031	1.125	1.344	.120	.150	.875	.344	.312	.683	.493	.524	1.250	.431	.462	.823
16	.969	1.125	1.219	1.438	.120	.150	1.000	.344	.312	.808	.493	.524	1.250	.431	.462	.949
18	1.062	1.203	1.312	1.516	.120	.150	1.125	.344	.312	.899	.493	.524	1.250	.431	.462	1.073
20	1.156	1.297	1.438	1.672	.120	.150	1.250	.406	.406	1.034	.650	.650	1.312	.556	.556	1.199
22	1.250	1.375	1.562	1.750	.120	.150	1.375	.406	.406	1.155	.650	.650	1.312	.556	.556	1.323
24	1.375	1.500	1.688	1.875	.147	.150	1.500	.436	.436	1.279	.683	.683	1.312	.589	.589	1.449

All dimensions for reference only.

PT06 CE SP06 CE straight plug

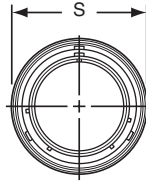

“CE” Open Wire Seal

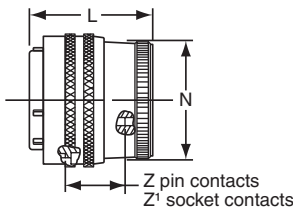

PT06CE-XX-XXX
SP06CE-XX-XXX

TERMINATION ASSEMBLIES
“CE” (SR) Strain Relief

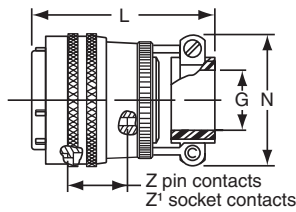

PT06CE-XX-XXX (SR)
SP06CE-XX-XXX (SR)

“CP” Potting Boot

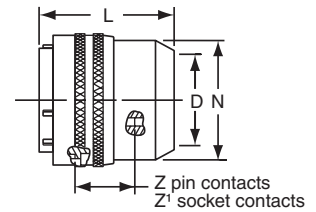

PT06CP-XX-XXX
SP06CP-XX-XXX

To complete part number see how to order on page 49.

Shell Size	Plug Front View	Plug Side View									
	S Dia. Max.	Z +.035 - .040	Z' +.035 - .040	Class “CE”		Class “CE” (SR)			Class “CP”		
				L Max.	N Dia.	G Dia.	H Max.	L Max.	D Dia.	L Max.	N Dia. Max.
6	.609	.772	.631	1.457	.440	—	—	—	—	—	—
8	.734	.772	.631	1.457	.560	.125	.797	2.019	.327	1.707	.608
10	.844	.772	.631	1.457	.685	.188	.859	2.019	.444	1.707	.734
12	1.016	.772	.631	1.457	.813	.312	.984	2.019	.558	1.707	.858
14	1.141	.772	.631	1.457	.930	.375	1.109	2.019	.683	1.707	.984
16	1.266	.772	.631	1.457	1.057	.500	1.172	2.144	.808	1.707	1.110
18	1.375	.772	.631	1.457	1.175	.625	1.422	2.144	.909	1.707	1.234
20	1.516	.710	.569	1.487	1.301	.625	1.422	2.175	1.034	1.707	1.360
22	1.641	.710	.569	1.487	1.428	.750	1.609	2.175	1.159	1.707	1.484
24	1.761	.710	.569	1.550	1.555	.800	1.703	2.237	1.284	1.832	1.610

All dimensions for reference only.

PT07 CE SP07 CE

jam nut receptacle

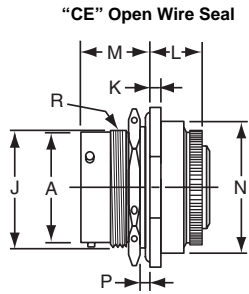
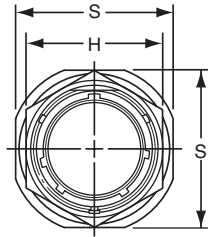

PT07CE-XX-XXX
SP07CE-XX-XXX

TERMINATION ASSEMBLIES "CE" (SR) Strain Relief

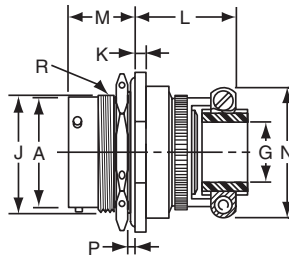

PT07CE-XX-XXX (SR)
SP07CE-XX-XXX (SR)

"CP" Potting Boot

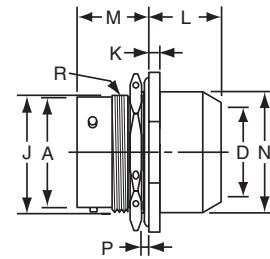

PT07CP-XX-XX
SP07CP-XX-XXX

To complete part number see how to order on page 49.
All lockwire holes are .044 Dia. Min.

Shell Size	Receptacle Front View		Receptacle Side View													
	H Hex.	S	A Dia.	J Flat	K	M	Panel Thickness		Class "CE"		Class "CE" (SR)			Class "CP"		
	+0.017 -0.016	±.016	+0.001 -0.005	+0.000 -0.010	±.016	±.005	Min.	Max.	L Max.	N Max.	G Dia.	L Max.	N Max.	D Dia. Min.	L Max.	N Dia. Max.
8	.750	.938	.473	.530	.125	.696	.062	.125	.827	.730	.125	1.297	.797	.327	.875	.608
10	.875	1.062	.590	.655	.125	.696	.062	.125	.827	.855	.188	1.297	.859	.444	.875	.734
12	1.062	1.250	.750	.818	.125	.696	.062	.125	.827	.980	.312	1.297	.984	.558	.875	.858
14	1.188	1.375	.875	.942	.125	.696	.062	.125	.827	1.105	.375	1.297	1.109	.683	.875	.984
16	1.312	1.500	1.000	1.066	.125	.696	.062	.125	.827	1.230	.500	1.422	1.172	.808	.875	1.110
18	1.438	1.625	1.125	1.191	.125	.696	.062	.125	.827	1.355	.625	1.422	1.422	.909	.875	1.234
20	1.562	1.812	1.250	1.316	.156	.884	.062	.250	.733	1.511	.625	1.328	1.422	1.034	.969	1.360
22	1.688	1.938	1.375	1.441	.156	.884	.062	.250	.733	1.636	.750	1.328	1.609	1.159	.969	1.484
24	1.812	2.062	1.500	1.566	.156	.917	.062	.250	.762	1.761	.800	1.422	1.703	1.284	.969	1.610

All dimensions for reference only.

PT08 CE SP08 CE 90 degree plug

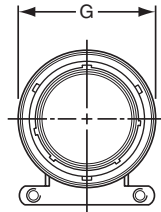

TERMINATION ASSEMBLIES

“CE” Open Wire Seal, “CE” (SR) Strain Relief

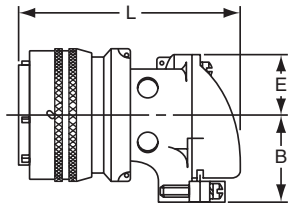

PT08CE-XX-XXX
SP08CE-XX-XXX
PT08CE-XX-XXX (SR)
SP08CE-XX-XXX (SR)

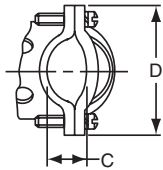

“CP” Potting Boot 75°

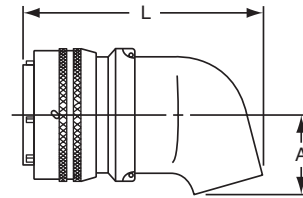

PT08CP-XX-XXX
SP08CP-XX-XXX

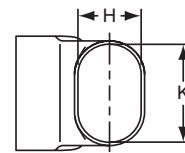

To complete part number see how to order on page 49.
All lockwire holes are .044 Dia. Min.

Shell Size	Plug Front View	Plug Side View								
	G Dia. Max.	Class “CE”, “CE” (SR)					Class “CP”			
		B ±.031	C +.010 - .025	D ±.062	E +.047 - .025	L ±.057	A ±.025	H ±.015	K ±.015	L Max.
8	.796	.655	.169	.941	.339	1.986	.469	.312	.438	1.906
10	.921	.749	.170	1.191	.393	2.080	.547	.438	.562	2.031
12	1.046	.812	.264	1.191	.450	2.165	.625	.516	.688	2.093
14	1.171	.905	.310	1.254	.519	2.313	.734	.625	.781	2.203
16	1.297	1.030	.330	1.316	.583	2.515	.750	.656	.890	2.250
18	1.422	1.015	.444	1.562	.621	2.623	.781	.703	1.000	2.296
20	1.562	1.077	.510	1.625	.683	2.739	.859	.766	1.125	2.343
22	1.672	1.139	.515	1.719	.739	2.785	.906	.812	1.234	2.390
24	1.797	1.265	.656	1.751	.797	3.024	1.169	.918	1.374	2.624

All dimensions for reference only.

PT-CE Breakaway twist pull plug

The PT-CE miniature breakaway connector has the following design features:

- crimp front release, front removable contacts in "CE" nylon wafer retention system
- 2 styles available: potted termination and environment style with a strain relief
- instant decoupling of plug and receptacle with an axial pull on the lanyard when they are fully mated
- intermateable with standard receptacles
- operating voltage to 900 VAC (RMS) at sea level
- quick positive bayonet coupling and 5 key/key-way polarization

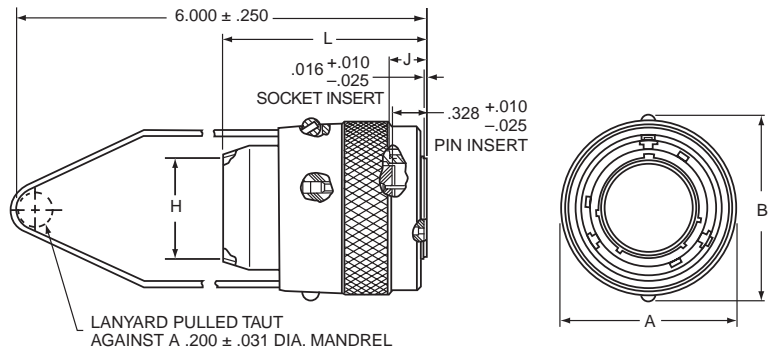

**Breakaway PT-CE with Crimp Contacts,
Potted Termination**
71-2512XX-()
72-2512XX-()

Part Number*	Part Number*	Shell Size	A Dia. Max.	B Max.	F Dia. ±.016	H Dia. ±.016	J ±.010	L Max.	L ₁ Max.
71-251209	71-339508	8	.875	.984	.125	.327	.353	1.937	2.937
71-251210	71-339510	10	1.125	1.125	.188	.444	.353	1.890	2.937
71-251211	71-339512	12	1.281	1.406	.312	.558	.353	1.906	3.000
71-251212	71-339514	14	1.438	1.562	.375	.683	.353	1.953	3.000
71-251213	71-339516	16	1.562	1.688	.500	.808	.353	2.000	3.187
71-251214	71-339518	18	1.718	1.844	.625	.909	.353	2.031	3.375
71-251215	71-339520	20	1.875	2.000	.625	1.034	.415	2.234	3.375
71-251216	71-339522	22	2.031	2.188	.750	1.159	.415	2.328	3.375
71-251217	71-339524	24	2.156	2.312	.800	1.284	.415	2.359	3.625

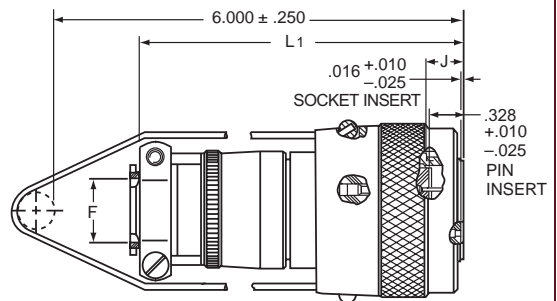

**Breakaway PT-CE with Crimp Contacts,
Environmental with Strain Relief**
71-3395XX-()
72-3395XX-()

All dimensions for reference only.

* See Finish information below to determine prefix 71 or 72 in part number.

Drawing above shows standard lanyard length.

Order by Amphenol Proprietary number as follows (example part number shown):

71 - 2512 50 - 32 P
1 2 3 4 5

1. Finish

"71" designates corrosion resistant olive drab cadmium plate

"72" designates anodic coated (electrically nonconductive-anodic) finish providing extreme wear and corrosion resistance, 500 hr. extended salt spray.

2. Connector Type Identification

2512XX designates PT-CE plug, crimp, potted termination style

3395XX designates PT-CE plug, crimp, environmental with strain relief style

3. Shell Size

See part number columns in chart above for 2 digit number at end that correlates to the shell size. Example: '50' correlates to shell size 18.

4. Insert Arrangement Number

See insert availability for Miniature Breakaway connectors on page 6. The number following the hyphen is the insert arrangement number.

5. Contact Type/Alternate Insert Rotation

P designates pin, S designates socket for normal positioning of inserts. When an alternate position of the insert is required to prevent cross-mating a different letter (other than P or S) is used. See page 7 for description of alternate positions; then convert to Amphenol proprietary coding by the chart at right to complete the part number.

Pin Contacts		Socket Contacts	
Amphenol Letter	Equates to MS letter	Amphenol Letter	Equates to MS letter
G	PW	H	SW
I	PX	J	SX
K	PY	L	SY
M	PZ	N	SZ

PT-CE, SP-CE

how to order

PT-CE, SP-CE

To more easily illustrate ordering procedure, part number PT00CE-20-41PW (SR) is shown as follows:

<u>PT</u>	<u>00</u>	<u>CE</u>	<u>-</u>	<u>20</u>	<u>-</u>	<u>41</u>	<u>P</u>	<u>W</u>	<u>(SR)</u>
1	2	3		4		5	6	7	8

See code below:

1. Connector Type
 - "PT" designates standard electrically conductive olive drab cadmium plated bayonet lock connector with crimp contacts
 - "SP" designates electrically non-conductive, hard anodic coated bayonet lock connector with large flange and mounting holes for back panel mounting, and crimp contacts.
2. Shell Style
 - "00" designates wall mounting receptacle
 - "01" designates cable connecting receptacle*
 - "02" designates box mounting receptacle
 - "06" designates straight plug
 - "07" designates jam nut receptacle
 - "08" designates 90° plug
3. Service Class
 - "CE" designates environmental crimp
 - "CP" designates potted type crimp

Both of the above are Amphenol® proprietary versions of the MIL-C-26482, Series 1 crimp contact connector and offer 7 lbs. contact retention for size 20 contacts; 9 lbs for size 16 contacts.
4. Shell Size
 - "20" designates shell size. Shell sizes 6 through 24 available.
5. Insert Arrangement
 - Refer to pages 4-11 for insert availability.
 - "20 - 41" designates insert arrangement. (The number following the hyphen is the number only that is used in the part number).
6. Contacts
 - "P" designates pin contacts.
 - "S" designates socket contacts.
7. Insert Rotation
 - Refer to page 7.
 - "W", "X", "Y", "Z" designate that insert is rotated in its shell from the "normal" position. No letter required for normal (no rotation) position.
8. "(SR)" designates strain relief clamp.
 - Indicate optional finishes as follows:
 - (003) olive drab cadmium plate (standard on "PT")
 - (005) anodic coating - Alumilite® (standard on "SP")
 - (014) olive drab cadmium plate over nickel
 - (023) electroless nickel
 - (024) olive drab zinc cobalt plating
 - (025) non-conductive black zinc cobalt plating
 - (027) conductive black zinc cobalt plating
 - (424) electroless nickel finish with strain relief
 - (466) olive drab zinc cobalt plating with strain relief
 - (470) non-conductive black zinc cobalt plating with strain relief
 - (476) conductive black zinc cobalt with strain relief

* This connector style is sometimes referred to as a cable connecting "plug". It does, however, mate with either a straight or 90 degree plug.

For ordering Miniature Breakaway PT-CE Crimp connectors see page 48.

Amphenol® PC

threaded coupling and solder termination

wall mounting
receptacle



cable
connecting
receptacle*



box mounting
receptacle



straight plug



jam nut
receptacle



Amphenol® PC Series threaded coupling miniature cylindrical connectors incorporate solder contacts. The PC double stub threaded coupling system cannot be cross threaded, and is mechanically assisted while engaging and disengaging.

Shell components are aluminum. Bright cadmium plating to QQ-P-416 with a clear chromate after-treatment provides a golden colored conductive finish. Single key/keyway polarization represents maximum simplicity in a design proven in millions of AN connectors.

Both pins and sockets are machined from a copper alloy and are gold plated. This gold plating eliminates contact corrosion and offers an indefinite shelf life. Socket contacts for these series are a closed entry design.

Both the insert and main joint gasket are molded from resilient neoprene. This provides excellent moisture sealing at the gasket and superior electrical insulation of the contacts in the insert.

The PC is intermateable and intermountable within the PC threaded coupling series.

Refer to pages 4-11 for insert arrangement availability.

* This connector style is sometimes referred to as a cable connecting "plug". It does, however, mate with either a straight or 90 degree plug.

PC-SE and PC-CE, which are threaded coupling and incorporate crimp contacts, are briefly covered on pages 62 and 63. It is necessary to contact Amphenol for ordering information on these types.

PC

Contact Specifications				
Contact Size	Test Current	Maximum Millivolt Drop†	Solder Well Diameter	Solder Well Depth
20	7.5	55	.046 ^{+0.004} _{-0.000}	.125 ^{+0.031} _{-0.000}
16	13.0	50	.078 ^{+0.005} _{-0.003}	.188 ^{+0.031} _{-0.000}

Service Rating					
Service Rating	Recommended Operating AC Voltage at Sea Level	Test Voltage AC (RMS), 60 cps			
		Sea Level	50,000 ft.	70,000 ft.	110,000 ft.
I	600	1,500	500	375	200
II	1,000	2,300	750	500	200

† Silver plated wire per MIL-C-26482

PC Service Classes

PC connectors are available in the service classes listed below. Each class except the hermetic seal receptacle has one or more means of terminating or supporting a cable or wire bundle.

- “A” General duty; back shell is threaded for conduit attachment of MS3057 cable clamp.
- “A” (SR) General duty; with strain relief clamp for cable or wire bundle support.
- “C” Pressurized receptacle; less than 1 cu. in. per hour leakage at 30 psi over a temperature range of -65°F to +257°F in accordance with BSC-C1P specification.
- “E” Environment resistant; with nut and grommet for moisture proofing individual wires.
- “E” (SR) Environment resistant strain relief clamp and grommet for moisture proofing individual wires; provides added wire bundle support.
- “P” Translucent nylon boot for retaining customer applied potting compounds; held in place by a threaded ring.
- “P” (SR) Strain relief clamp suitable for retaining customer applied potting compounds, with provision for wire support.
- “W” Compressing clamp and neoprene gland for moisture proofing multi-conductor jacketed cables. Telescoping sleeves (MS 3420A) can be used to adapt to cables smaller than minimum close down.
- “H”* Hermetically sealed with compression glass inserts.

Refer to pages 57-60 for Hermetic Versions within the PC solder series.



PC SERIES
THREADED COUPLING
WITH SOLDER CONTACTS

PC00

wall mounting receptacle

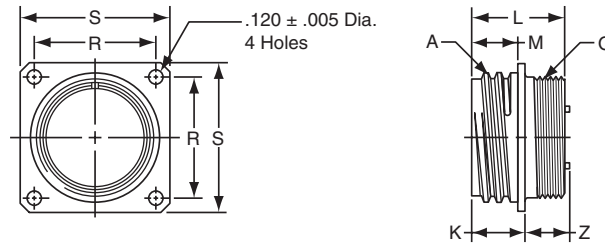

TERMINATION ASSEMBLIES

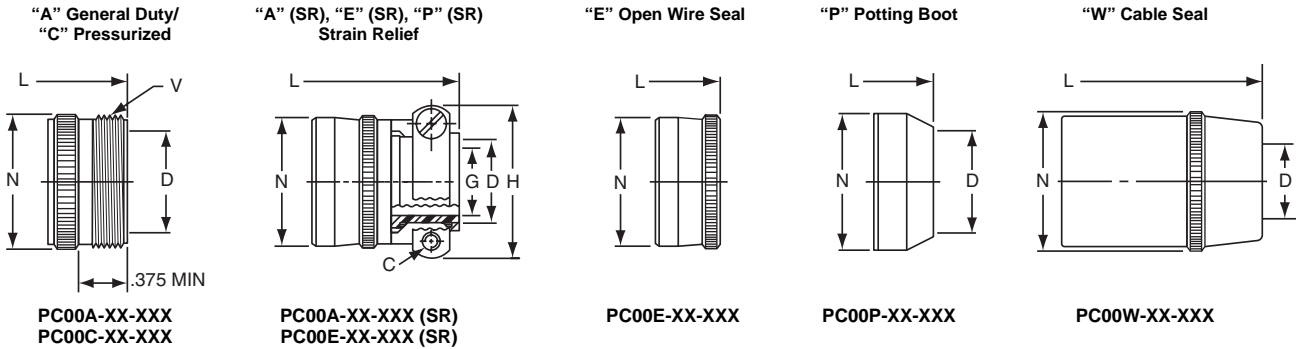

To complete part number see how to order on page 61.

Shell Size	Receptacle Front View		Receptacle Side View									
	R ±.005	S ±.010	A Thread Class 2A	K Max.	L Max.	M +.000 -.010	Q Thread Class 2A	Z Max.	Class "A", "C"			
									D Min.	L Max.	N Max.	V Thread Class 2A
6	.469	.688	.3750 DS	.490	.875	.416	.3125-32 NEF	.466	.175	1.528	.462	.3750-32 NEF
8	.594	.812	.5000 DS	.490	.875	.416	.4375-28 UNEF	.466	.297	1.528	.590	.5000-28 UNEF
10	.719	.938	.6250 DS	.490	.875	.416	.5625-24 NEF	.466	.421	1.528	.717	.6250-24 NEF
12	.812	1.031	.7500 DS	.490	.875	.416	.6875-24 NEF	.466	.546	1.528	.834	.7500-20 UNEF
14	.906	1.125	.8750 DS	.490	.875	.416	.8125-20 UNEF	.466	.663	1.528	.970	.8750-20 UNEF
16	.969	1.219	1.0000 DS	.490	.875	.416	.9375-20 UNEF	.466	.787	1.528	1.088	1.0000-20 UNEF
18	1.062	1.312	1.1250 DS	.490	.875	.416	1.0625-18 UNEF	.466	.879	1.528	1.216	1.1875-18 NEF
20	1.156	1.438	1.2500 DS	.584	1.031	.479	1.1875-18 NEF	.527	1.014	1.588	1.332	1.1875-18 NEF
22	1.250	1.562	1.3750 DS	.584	1.031	.479	1.3125-18 NEF	.527	1.135	1.588	1.460	1.4375-18 NEF

Shell Size	Class "A" (SR), "E" (SR), "P" (SR)						Class "E"		Class "P"			Class "W"			
	C Thread	D Min.	G Dia.	H Max.	L Max.	N Max.	L Max.	N Max.	D Min.	L Max.	N Max.	D		L Max.	N Max.
												Closed	Free		
6	-	-	-	-	-	-	1.250	.440	.192	1.406	.484	-	-	-	-
8	6-32	.240	.125	.812	1.922	.550	1.250	.560	.317	1.406	.608	.168	.230	1.680	.547
10	6-32	.302	.188	.875	1.922	.675	1.250	.685	.434	1.406	.734	.205	.312	1.680	.675
12	6-32	.428	.312	1.000	1.922	.803	1.250	.813	.548	1.406	.858	.338	.442	1.823	.812
14	6-32	.552	.375	1.125	1.922	.920	1.250	.930	.673	1.406	.984	.416	.539	2.015	.940
16	6-32	.615	.500	1.188	2.047	1.047	1.250	1.057	.798	1.406	1.110	.550	.616	2.231	1.067
18	8-32	.740	.625	1.438	2.078	1.165	1.250	1.175	.899	1.406	1.234	.600	.672	2.461	1.194
20	8-32	.740	.625	1.438	2.344	1.290	1.434	1.301	1.024	1.562	1.360	.635	.747	2.835	1.322
22	8-32	.928	.750	1.719	2.344	1.418	1.434	1.430	1.149	1.562	1.484	.670	.846	2.999	1.449

All dimensions for reference only.

PC01

cable connecting receptacle

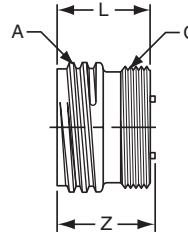
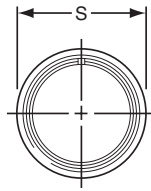

TERMINATION ASSEMBLIES

"A" General Duty

"A" (SR), "E" (SR), "P" (SR)
Strain Relief

"E" Open Wire Seal

"P" Potting Boot

"W" Cable Seal

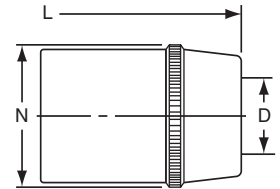
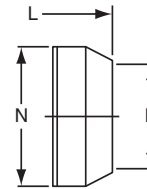
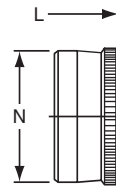
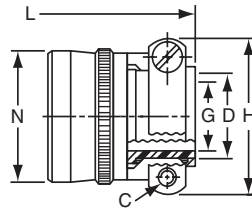
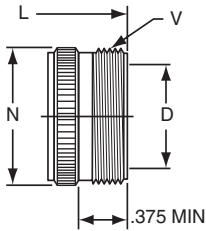

PC01A-XX-XXX

PC01A-XX-XXX (SR)
PC01E-XX-XXX (SR)
PC01P-XX-XXX (SR)

PC01E-XX-XXX

PC01P-XX-XXX

PC01W-XX-XXX

Note: This connector style is sometimes referred to as a cable connecting "plug".
It does, however, mate with either a straight or 90 degree plug.
To complete part number see how to order on page 61.

Shell Size	Recept. Front View		Receptacle Side View						
	S Max.	A Thread Class 2A	L Max.	Q Thread Class 2A	Z Max.	Class "E"			
						D Min.	L Max.	N Max.	V Thread Class 2A
6	.442	.3750 DS	.875	.3125-32 NEF	.924	.175	1.518	.462	.3750-32 NEF
8	.570	.5000 DS	.875	.4375-28 UNEF	.924	.297	1.518	.590	.5000-28 UNEF
10	.697	.6250 DS	.875	.5625-24 NEF	.924	.421	1.518	.717	.6250-24 NEF
12	.814	.7500 DS	.875	.6875-24 NEF	.924	.546	1.518	.834	.7500-20 UNEF
14	.950	.8750 DS	.875	.8125-20 UNEF	.924	.663	1.518	.970	.8750-20 UNEF
16	1.068	1.0000 DS	.875	.9375-20 UNEF	.924	.787	1.518	1.088	1.0000-20 UNEF
18	1.196	1.1250 DS	.875	1.0625-18 NEF	.924	.879	1.518	1.216	1.1875-18 NEF
20	1.312	1.2500 DS	1.031	1.1875-18 NEF	1.081	1.014	1.578	1.332	1.1875-18 NEF
22	1.440	1.3750 DS	1.031	1.3125-18 NEF	1.081	1.135	1.578	1.460	1.4375-18 NEF

Shell Size	Class "A" (SR), "E" (SR), "P" (SR)						Class "E"		Class "P"			Class "W"			
	C Thread	D Min.	G Dia.	H Max.	L Max.	N Max.	L Max.	N Max.	D Min.	L Max.	N Max.	D		L Max.	N Max.
												Closed	Free		
6	-	-	-	-	-	-	1.250	.440	.192	1.406	.484	-	-	-	-
8	6-32	.240	.125	.812	1.922	.550	1.250	.560	.317	1.406	.608	.168	.230	1.680	.547
10	6-32	.302	.188	.875	1.922	.675	1.250	.685	.434	1.406	.734	.205	.312	1.680	.675
12	6-32	.428	.312	1.000	1.922	.803	1.250	.813	.548	1.406	.858	.338	.442	1.823	.812
14	6-32	.552	.375	1.125	1.922	.920	1.250	.930	.673	1.406	.984	.416	.539	2.015	.940
16	6-32	.615	.500	1.188	2.047	1.047	1.250	1.057	.798	1.406	1.110	.550	.616	2.231	1.067
18	8-32	.740	.625	1.438	2.078	1.165	1.250	1.175	.899	1.406	1.234	.600	.672	2.461	1.194
20	8-32	.740	.625	1.438	2.344	1.290	1.434	1.301	1.024	1.562	1.360	.635	.747	2.835	1.322
22	8-32	.928	.750	1.719	2.344	1.418	1.434	1.430	1.149	1.562	1.484	.670	.846	2.999	1.449

All dimensions for reference only.

PC02

box mounting receptacle

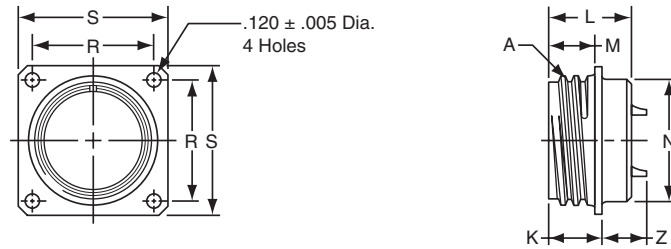

- PC02A-XX-XXX
- * PC02C-XX-XXX
- * PC02E-XX-XXX
- * PC02P-XX-XXX

To complete part number see how to order on page 61.

* The PC02 Box Mounting Receptacle is made only to complete a series and no provision is made for accessories or potting on the rear skirt.

Shell Size	Receptacle Front View		Receptacle Side View					
	R ±.005	S ±.010	A Thread Class 2A	K +.020 -0.010	L Max.	M +.010 -0.000	N Max.	Z Max.
6	.469	.688	.3750 DS	.469	.801	.406	.323	.466
8	.594	.812	.5000 DS	.469	.801	.406	.449	.466
10	.719	.938	.6250 DS	.469	.801	.406	.573	.466
12	.812	1.031	.7500 DS	.469	.801	.406	.699	.466
14	.906	1.125	.8750 DS	.469	.801	.406	.823	.466
16	.969	1.219	1.0000 DS	.469	.801	.406	.949	.466
18	1.062	1.312	1.1250 DS	.469	.801	.406	1.073	.466
20	1.156	1.438	1.2500 DS	.562	.988	.469	1.199	.527
22	1.250	1.562	1.3750 DS	.562	.988	.469	1.323	.527

All dimensions for reference only.

PC06

straight plug

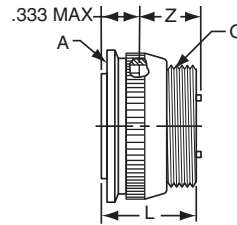
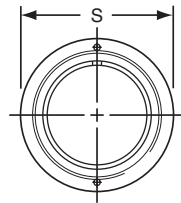

TERMINATION ASSEMBLIES

"A" General Duty

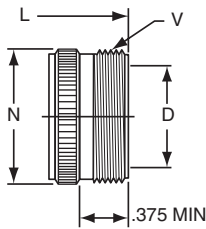

PC06A-XX-XXX

"A" (SR), "E" (SR), "P" (SR) Strain Relief

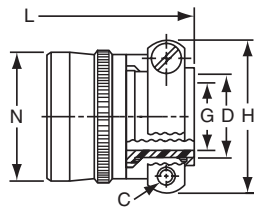

PC06A-XX-XXX (SR)
PC06E-XX-XXX (SR)
PC06P-XX-XXX (SR)

"E" Open Wire Seal

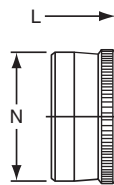

PC06E-XX-XXX

"P" Potting Boot

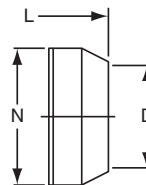

PC06P-XX-XXX

"W" Cable Seal

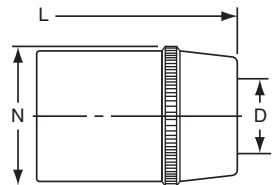

PC06W-XX-XXX

To complete part number see how to order on page 61.

Shell Size	Plug Front View		Plug Side View						
	S Max.	A Thread Class 2B	L Max.	Q Thread Class 2A	Z Max.	Class "A"			
						D Min.	L Max.	N Max.	V Thread Class 2A
6	.604	.3750 DS	.875	.3125-32 NEF	.627	.175	1.534	.462	.3750-32 NEF
8	.729	.5000 DS	.875	.4375-28 UNEF	.627	.297	1.534	.590	.5000-28 UNEF
10	.854	.6250 DS	.875	.5625-24 NEF	.627	.421	1.534	.717	.6250-24 NEF
12	.979	.7500 DS	.875	.6875-24 NEF	.627	.546	1.534	.834	.7500-20 UNEF
14	1.104	.8750 DS	.875	.8125-20 UNEF	.627	.663	1.534	.972	.8750-20 UNEF
16	1.229	1.0000 DS	.875	.9375-20 UNEF	.627	.787	1.534	1.088	1.0000-20 UNEF
18	1.354	1.1250 DS	.875	1.0625-18 UNEF	.627	.879	1.534	1.216	1.1875-18 NEF
20	1.478	1.2500 DS	1.031	1.1875-18 NEF	.783	1.014	1.613	1.332	1.1875-18 NEF
22	1.604	1.3750 DS	1.031	1.3125-18 NEF	.783	1.135	1.613	1.460	1.4375-18 NEF

Shell Size	Class "A" (SR), "E" (SR), "P" (SR)						Class "E"		Class "P"			Class "W"			
	C Thread	D Min.	G Dia.	H Max.	L Max.	N Max.	L Max.	N Max.	D Min.	L Max.	N Max.	D		L Max.	N Max.
												Closed	Free		
6	-	-	-	-	-	-	1.250	.440	.192	1.406	.484	-	-	-	-
8	6-32	.240	.125	.812	1.906	.550	1.250	.560	.317	1.406	.608	.168	.230	1.680	.547
10	6-32	.302	.188	.875	1.906	.675	1.250	.685	.434	1.406	.734	.205	.312	1.680	.675
12	6-32	.428	.312	1.000	1.906	.803	1.250	.813	.548	1.406	.858	.338	.442	1.823	.812
14	6-32	.552	.375	1.125	1.906	.920	1.250	.930	.673	1.406	.984	.416	.539	2.015	.940
16	6-32	.615	.500	1.188	2.047	1.047	1.250	1.057	.798	1.406	1.110	.550	.616	2.231	1.067
18	8-32	.740	.625	1.438	2.078	1.165	1.250	1.175	.899	1.406	1.234	.600	.672	2.461	1.194
20	8-32	.740	.625	1.438	2.250	1.290	1.434	1.301	1.024	1.562	1.360	.635	.747	2.835	1.322
22	8-32	.928	.750	1.719	2.250	1.418	1.434	1.430	1.149	1.562	1.484	.670	.846	2.999	1.449

All dimensions for reference only

PC07

jam nut receptacle

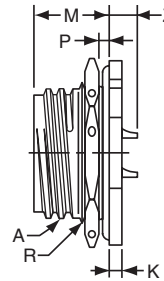
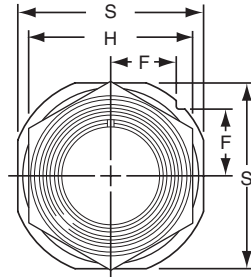

General Duty/
Pressurized Receptacle
7A-XX-XXX
7C-XX-XXX

"E" Open Wire Seal

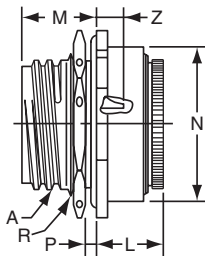

PC07E-XX-XXX

TERMINATION ASSEMBLIES
"A" (SR), "E" (SR) Strain Relief

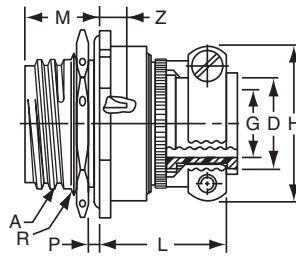

PC07A-XX-XXX (SR)
PC07E-XX-XXX (SR)

"P" Potting Boot

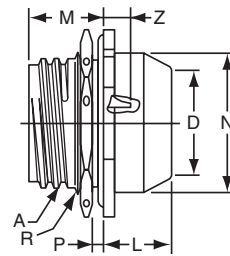

PC07P-XX-XXX

To complete part number see how to order on page 61.

Shell Size	Receptacle Front View			Receptacle Side View Class "A", "C"						
	F	H	S	A	K	M	P		R	Z
	±.010	Hex ±.016	±.010	Thread Class 2A	+016 -.010	±.010	Min.	Max.	Thread Class 2A	Max.
6	.286	.625	.812	.3750 DS	.125	.671	.062	.125	.4375-28 UNEF	.232
8	.331	.750	.938	.5000 DS	.125	.671	.062	.125	.5625-24 NEF	.232
10	.375	.875	1.062	.6250 DS	.125	.671	.062	.125	.6875-24 NEF	.232
12	.442	1.062	1.250	.7500 DS	.125	.671	.062	.125	.8750-20 UNEF	.232
14	.486	1.188	1.375	.8750 DS	.125	.671	.062	.125	1.0000-20 UNEF	.232
16	.530	1.312	1.500	1.0000 DS	.125	.671	.062	.125	1.1250-18 NEF	.232
18	.573	1.438	1.625	1.1250 DS	.125	.671	.062	.125	1.2500-18 NEF	.232
20	.641	1.562	1.812	1.2500 DS	.156	.797	.062	.250	1.3750-18 NEF	.262
22	.685	1.688	1.938	1.3750 DS	.156	.797	.062	.250	1.5000-18 NEF	.262

Shell Size	Class "E"		Class "A" (SR), "E" (SR)				Class "P"			
	L Max.	N Max.	C Thread	G Dia.	H Max.	L Max.	P Min.	D Min.	L Max.	N Max.
6	.692	.605	-	-	-	-	-	.192	.665	.484
8	.692	.730	6-32	.125	.812	1.096	.240	.317	.665	.608
10	.692	.855	6-32	.188	.875	1.096	.302	.434	.665	.734
12	.692	.980	6-32	.312	1.000	1.096	.428	.548	.665	.858
14	.692	1.105	6-32	.375	1.125	1.096	.552	.673	.665	.984
16	.692	1.230	6-32	.500	1.188	1.228	.651	.798	.665	1.110
18	.692	1.355	8-32	.625	1.438	1.228	.740	.899	.665	1.234
20	.754	1.511	8-32	.625	1.438	1.291	.740	1.024	.790	1.360
22	.754	1.636	8-32	.750	1.625	1.291	.928	1.149	.790	1.484

All dimensions for reference only

PC hermetic

Three shell styles are available in the hermetic PC threaded series:

- **PCIH**
- **PC02H**
- **PC07H**

These hermetic connectors are available with solder cup or flat eyelet pin contacts. Socket contacts are available in some versions. Other design characteristics of the PC hermetic connector series are as follows:

Shell Size: 6 thru 22. (tin plated)

Contact count: 2 through 65. Refer to pages 4 and 5 for insert availability for hermetics.

Current: 5.0 amp, each #20 contact;
10 amp, each #16 contact;
17 amp, each #12 contact.

Contacts: Fabricated from high nickel alloy and tin plated.

Dielectric Withstanding Voltage (sea level):
1500 volts (RMS) 60 cps Service Rating I;
2300 volts (RMS) 60 cps Service Rating II.

Compression glass inserts, permanently lettered.

Helium Leakage: Less than 1.0×10^{-6} cc/sec.
at 15 psi differential.

Physical Shock: 100 G's.

Vibration: Exceeds MIL-E-5272 Procedure II.

Thermal Shock: No deterioration or failure after
5 cycles at -55°F to $+257^{\circ}\text{F}$.

Refer to pages 4-11 for insert arrangement availability.

**solder
mounting
receptacle**



**box
mounting
receptacle**



**jam nut
receptacle**



PCIH

hermetic solder mounting receptacle

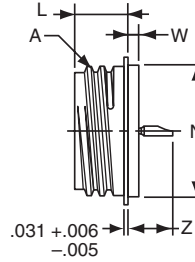
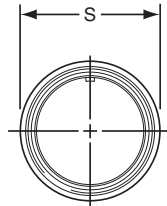

* PCIH-XX-XXX
 ** PCIY-XX-XXX

To complete part number see how to order on page 61.

* Solder cup pin contacts without interfacial seal.

** Solder cup pin contacts with interfacial seal

Shell Size	Receptacle Front View	Receptacle Side View				
	S Dia. Max.	A Thread Class 2A	L +.025 -0.016	N Dia. +.000 -0.005	W +.011 -0.010	Z Max.
6	.511	.3750 DS	.422	.438	.094	.387
8	.636	.5000 DS	.422	.562	.094	.387
10	.761	.6250 DS	.422	.672	.094	.387
12	.855	.7500 DS	.422	.781	.094	.387
14	.980	.8750 DS	.422	.906	.094	.387
16	1.105	1.0000 DS	.422	1.031	.094	.387
18	1.229	1.1250 DS	.422	1.156	.094	.387
20	1.323	1.2500 DS	.422	1.250	.094	.387
22	1.439	1.3750 DS	.422	1.375	.125	.418

All dimensions for reference only.

PC02H

hermetic box mounting receptacle

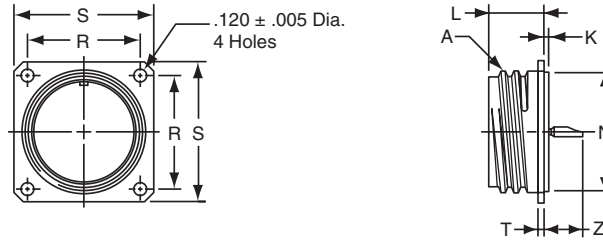

* PC02H-XX-XXX
 ** PC02Y-XX-XXX

To complete part number see how to order on page 61.
 * Solder cup pin contacts without interfacial seal.
 ** Solder cup pin contacts with interfacial seal

Shell Size	Receptacle Front View		Receptacle Side View					
	R ±.005	S ±.010	A Thread Class 2A	K ±.016	L +.010 -.000	N Dia. +.000 -.005	T ±.010	Z Max.
6	.469	.688	.3750 DS	.047	.469	.438	.062	.344
8	.594	.812	.5000 DS	.047	.469	.562	.062	.344
10	.719	.938	.6250 DS	.047	.469	.672	.062	.344
12	.812	1.031	.7500 DS	.047	.469	.781	.062	.344
14	.906	1.125	.8750 DS	.047	.469	.906	.062	.344
16	.969	1.219	1.0000 DS	.047	.469	1.031	.062	.344
18	1.062	1.312	1.1250 DS	.047	.469	1.156	.062	.344
20	1.156	1.438	1.2500 DS	.047	.469	1.250	.062	.344
22	1.250	1.562	1.3750 DS	.078	.469	1.375	.062	.377

All dimensions for reference only.

PC07H

hermetic jam nut receptacle

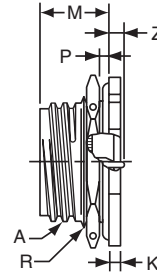
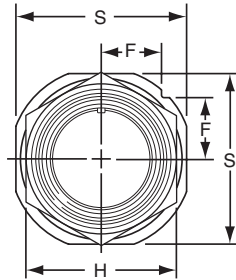

* PC07H-XX-XXX
 ** PC07Y-XX-XXX

To complete part number see how to order on page 61.

* Solder cup pin contacts without interfacial seal.

** Solder cup pin contacts with interfacial seal

Shell Size	Receptacle Front View			Receptacle Side View						
	F	H Hex.	S	A Thread Class 2A	K	M	Panel Thickness		R Thread Class 2A	Z
	+ .010	± .016	+ .010		+ .000 - .016	± .020	Min	Max.		+ .010
6	.286	.625	.812	.3750 DS	.094	.671	.062	.125	.4375-28 UNEF	.129
8	.331	.750	.938	.5000 DS	.094	.671	.062	.125	.5625-24 NEF	.129
10	.375	.875	1.062	.6250 DS	.094	.671	.062	.125	.6875-24 NEF	.129
12	.442	1.062	1.250	.7500 DS	.094	.671	.062	.125	.8750-20 UNEF	.129
14	.486	1.188	1.375	.8750 DS	.094	.671	.062	.125	1.0000-20 UNEF	.129
16	.530	1.312	1.500	1.0000 DS	.094	.671	.062	.125	1.1250-18 NEF	.129
18	.573	1.438	1.625	1.1250 DS	.094	.671	.062	.125	1.2500-18 NEF	.129
20	.641	1.562	1.812	1.2500 DS	.125	.797	.062	.250	1.3750-18 NEF	.034
22	.685	1.688	1.938	1.3750 DS	.125	.797	.062	.250	1.5000-18 NEF	.034

All dimensions for reference only.

PC

how to order

PC

To more easily illustrate ordering procedure, part number PC00A-20-41PW (SR) is shown as follows:

<u>PC</u>	<u>00</u>	<u>A</u>	<u>-</u>	<u>20</u>	<u>-</u>	<u>41</u>	<u>P</u>	<u>W</u>	<u>(SR)</u>
1	2	3		4		5	6	7	8

See code below:

1. Connector Type
"PC" designates bright cadmium plated with clear chromate after treatment, threaded coupling connector with solder contacts
2. Shell Style
"00" designates wall mounting receptacle
"01" designates cable connecting receptacle†
"02" designates box mounting receptacle
"06" designates straight plug
"07" designates jam nut receptacle
"I" designates solder-mount receptacle (hermetic only)
3. Service Class
"A" designates general duty back shell
"C" designates pressurized receptacle
"E" designates environmental resisting open wire seal with grommet and nut
"P" designates potted with potting boot
"W" designates clamp assembly for moisture proofing, multi-jacketed cables
"H" designates hermetic* seal (without interfacial seal)
"Y" designates hermetic* seal (with interfacial seal)
4. Shell Size
"20" designates shell size. Shell sizes 6 through 24 available.
5. Insert Arrangement
Refer to pages 4-11 for insert availability.
"20 - 41" designates insert arrangement. (The number following the hyphen is the number only that is used in the part number).
6. Contacts
"P" designates pin contacts.
"S" designates socket contacts.
7. Insert Rotation
Refer to page 7.
"W", "X", "Y", "Z" designate that insert is rotated in its shell from the "normal" position. No letter required for normal (no rotation) position.
8. "(SR)" designates strain relief clamp.
Indicate optional finishes as follows:
(001) bright cadmium (standard on "PC")
(003) olive drab cadmium plate
(005) anodic coating - Alumilite®
(011) chromate treated (Iridite 14-2)
(014) olive drab cadmium plate over nickel
(023) electroless nickel

* Hermetic connectors are supplied with tin plated shells.

† This connector style is sometimes referred to as a cable connecting "plug". It does, however, mate with either a straight or 90 degree plug.

Amphenol® PC-SE, PC-CE threaded coupling and crimp termination



Amphenol® PC-SE Series threaded coupling miniature cylindrical connectors incorporate crimp contacts in a spring tower retention system.

Amphenol® PC-CE Series threaded coupling miniature cylindrical connectors incorporate crimp contacts in a nylon wafer retention system to maintain contact position.

The PC double stub threaded coupling system cannot be cross threaded, and is mechanically assisted while engaging and disengaging.

Shell components are aluminum. Bright cadmium plating to QQ-P-416 with a clear chromate after-treatment provides a golden colored conductive finish. Single key/keyway polarization represents maximum simplicity in a design proven in millions of AN connectors.

Both pins and sockets are machined from a copper alloy and are gold plated. This gold plating eliminates contact corrosion and offers an indefinite shelf life. Socket contacts for these series are a closed entry design.

Both the insert and main joint gasket are molded from resilient neoprene. This provides excellent moisture sealing at the gasket and superior electrical insulation of the contacts in the insert.

The PC-SE and PC-CE are only intermateable and intermountable within the PC threaded coupling series.

Shell style drawing pages are not shown in this catalog for the PC-SE and PC-CE styles. If connector drawings are needed please contact Amphenol for assistance. Shell styles are currently available in these series as follows:

- PC00-SE, wall mounting receptacle
- PC01-SE, cable connecting receptacle
- PC02-SE, box mounting receptacle
- PC06-SE, straight plug
- PC08-SE, 90 degree plug
- PC06-CE straight plug (will mate with PC-SE receptacles and PC solder receptacles)

Please contact Amphenol for complete information, as there may be limitations in shell sizes within the PC-SE and PC-CE series.

Refer to pages 4-11 for insert arrangement availability.

* This connector style is sometimes referred to as a cable connecting "plug". It does, however, mate with either a straight or 90 degree plug.

PC-SE. PC-CE

Contact Specifications				
Contact Size	Test Current	Maximum Millivolt Drop†	Crimp Well Diameter	Minimum Well Depth
20	7.5	55	.049 ±.001	.267
16	13.0	49	.067 ±.001	.236
12	23.0	42	.100 ±.002	.236

Service Rating					
Service Rating	Recommended Operating AC Voltage at Sea Level	Test Voltage AC (RMS), 60 cps			
		Sea Level	50,000 ft.	70,000 ft.	110,000 ft.
I	600	1,500	500	375	200
II	1,000	2,300	750	500	200

† Silver plated wire per MIL-C-26482

PC-SE and PC-CE Service Classes

PC-SE and PC-CE connectors are available in the three service classes listed below.

“SE” Open wire sealing - environmental resistant, with a nut and grommet for moisture proofing individual wires

“SE” (SR) Strain relief clamp - environmental resistant strain relief clamp and grommet for moisture proofing individual wires; provides added wire bundle support

“SP” Translucent nylon boot for retaining customer applied potting compounds; held in place by a threaded ring

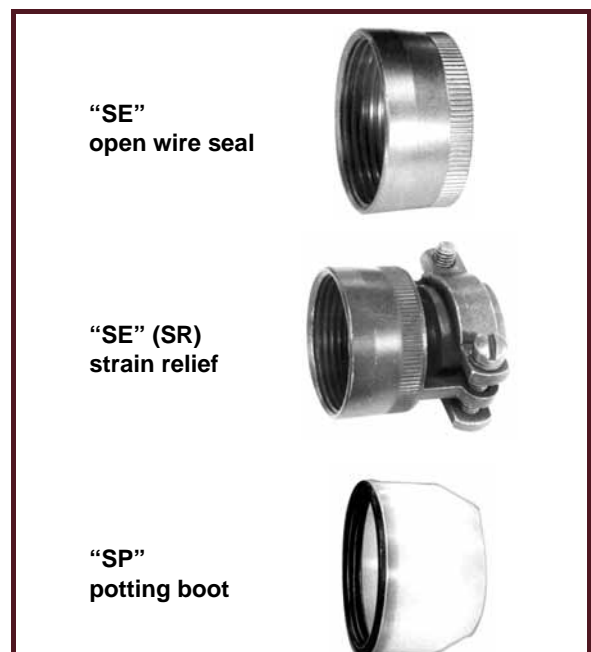

PC-SE, PC-CE

how to order

PC-SE, PC-CE

To more easily illustrate ordering procedure, part number PC-SE00A-20-41PW (SR) is shown as follows:

PC-SE	00	SP	-	20	-	41	P	W	(SR)
1	2	3		4		5	6	7	8

See code below:

1. Connector Type
 - "PC-SE" designates bright cadmium plated with clear chromate after treatment, threaded coupling connector with crimp contacts, incorporating a spring tower retention system
 - "PC-CE" designates bright cadmium plated with clear chromate after treatment, threaded coupling connector with crimp contacts, incorporating a nylon wafer retention system to maintain contact position
2. Shell Styles PC-SE - consult Amphenol for availability.
 - "00" designates wall mounting receptacle
 - "01" designates cable connecting receptacle†
 - "02" designates box mounting receptacle
 - "06" designates straight plug
 - "08" designates 90 degree plug
2. Shell Style PC-CE - consult Amphenol for availability.
 - "06" designates straight plug
3. Service Class
 - "SE" designates environmental crimp
 - "SP" designates potted type crimp

Both of the above are Amphenol® proprietary versions of the MIL-C-26482, Series 1 crimp contact connector and offer 7 lbs. contact retention for size 20 contacts; 9 lbs for size 16 contacts.)
4. Shell Size
 - "20" designates shell size. Please contact Amphenol for complete information, as there may be limitations in shell sizes with the PC-SE and PC-CE series.
5. Insert Arrangement
 - Refer to pages 4-11 for insert availability.
 - "20 - 41" designates insert arrangement. (The number following the hyphen is the number only that is used in the part number).
6. Contacts
 - "P" designates pin contacts.
 - "S" designates socket contacts.
7. Insert Rotation
 - Refer to page 7.
 - "W", "X", "Y", "Z" designate that insert is rotated in its shell from the "normal" position. No letter required for normal (no rotation) position.
8. "(SR)" designates strain relief clamp.
 - Indicate optional finishes as follows:
 - (001) bright cadmium (standard on "PC")
 - (003) olive drab cadmium plate
 - (005) anodic coating - Alumilite®
 - (011) chromate treated (Iridite 14-2)
 - (014) olive drab cadmium plate over nickel
 - (023) electroless nickel

† This connector style is sometimes referred to as a cable connecting "plug". It does, however, mate with either a straight or 90 degree plug.



PT, SP, PC

accessories – sealing plugs, flange gaskets, potting boots

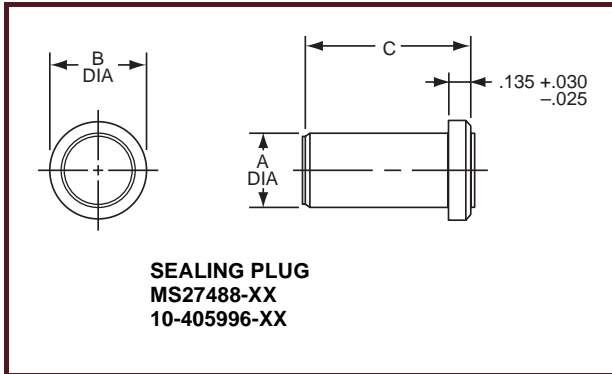

SEALING PLUGS – FOR PT, SP, PC

Contact Size	Amphenol® Part Number	MS Number	A Dia. ±.010	B Dia. ±.005	C ±.010	Color Code
12	10-405996-12	MS27488-12	.121	.171	.564	Yellow
16	10-405996-16	MS27488-16	.083	.133	.564	Blue
20	10-405996-20	MS27488-20	.060	.090	.564	Red

How to Order: Order by 10- (Proprietary) or MS part number as shown in chart above.

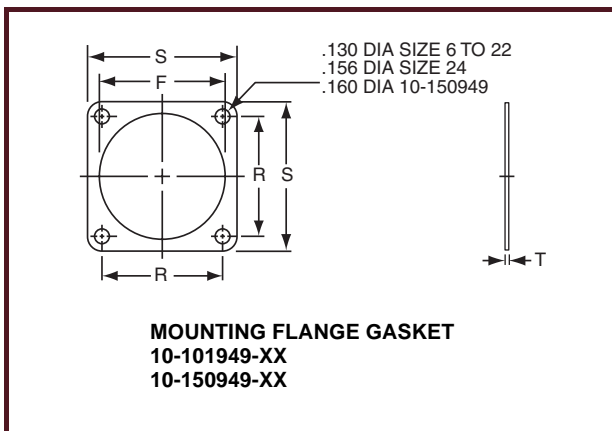

MOUNTING FLANGE GASKETS – FOR PT, SP, PC

Shell Size	PT, PC 10-101949		SP 10-150949		PT, SP, PC 10-101949 10-150949	
	R ±.010	S ±.010	R ±.010	S ±.010	F +.016 -.000	T ±.008
6	.469	.688	.641	.953	.375	.024
8	.594	.812	.734	1.047	.500	.024
10	.719	.938	.812	1.125	.625	.024
12	.813	1.031	.938	1.250	.750	.024
14	.906	1.125	1.031	1.344	.875	.024
16	.906	1.219	1.125	1.438	1.000	.024
18	1.063	1.312	1.203	1.516	1.125	.024
20	1.156	1.438	1.297	1.672	1.250	.024
22	1.250	1.563	1.375	1.750	1.375	.024
24	1.375	1.688	1.500	1.875	1.500	.024

How to Order: For PT, PC: 10-101949-XX (complete order number with desired shell size).
 For SP: 10-150949-XX (complete order number with desired shell size).

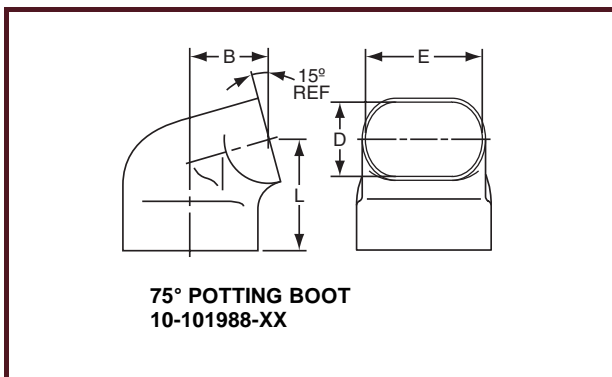

75° POTTING BOOTS – FOR PT, SP, PC

Shell Size	B Max.	D ±.015	E ±.015	L Max.
8	.433	.312	.438	.766
10	.493	.438	.562	.830
12	.552	.516	.688	.861
14	.643	.625	.781	.916
16	.658	.656	.890	.936
18	.689	.703	1.000	.959
20	.750	.766	1.125	1.052
22	.794	.812	1.234	1.073
24	1.070	.918	1.374	1.310

How to Order: 10-101988-XX (complete order number with desired shell size).

All dimensions for reference only.

PT, SP, PC accessories – clamps

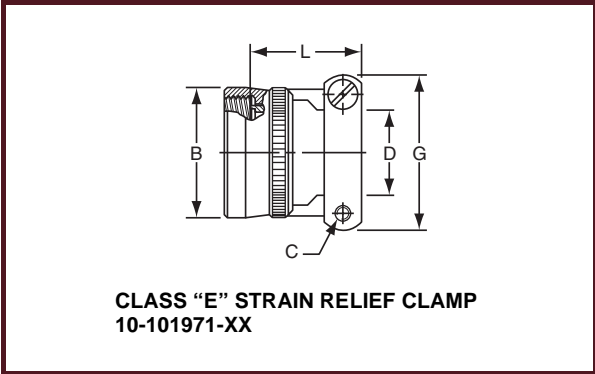

CLASS "E" STRAIN RELIEF CLAMP – FOR PT, SP, PC

Shell Size	B Max.	C Thread Class 2B	D Min.	G Max.	L Max.
8	.550	6-32 NC	.240	.812	.930
10	.675	6-32 NC	.302	.875	.930
12	.803	6-32 NC	.428	1.000	.930
14	.920	6-32 NC	.552	1.125	.930
16	1.047	6-32 NC	.615	1.188	1.062
18	1.165	8-32 NC	.740	1.438	1.062
20	1.291	8-32 NC	.740	1.438	1.093
22	1.418	8-32 NC	.928	1.719	1.093
24	1.533	8-32 NC	.928	1.719	1.093

How to Order: 10-101971-XX X

Add desired shell size Add desired finish suffix†
 "1" designates bright cadmium with clear chromate
 "3" designates olive drab cadmium
 "5" designates Alumilite®

Not for use with jam nut style connectors.

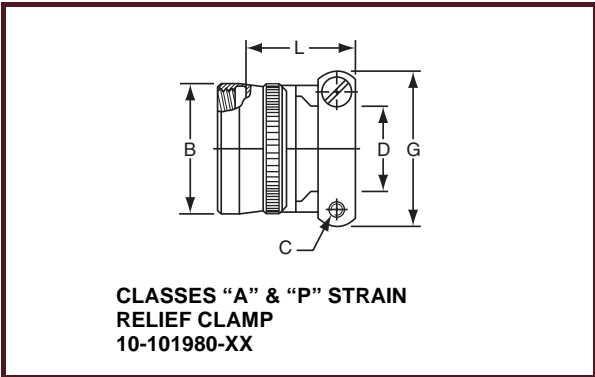

CLASSES "A" & "P" STRAIN RELIEF CLAMP – FOR PT, SP, PC

Shell Size	B Max.	C Thread Class 2B	D Min.	G Max.	L +.010 - .020
8	.540	6-32 NC	.240	.812	.843
10	.665	6-32 NC	.302	.875	.843
12	.793	6-32 NC	.428	1.000	.843
14	.910	6-32 NC	.552	1.125	.843
16	1.037	6-32 NC	.614	1.188	.975
18	1.155	8-32 NC	.740	1.438	.975
20	1.281	8-32 NC	.740	1.438	1.007
22	1.408	8-32 NC	.928	1.719	1.007
24	1.533	8-32 NC	.938	1.719	1.007

How to Order: 10-101980-XX X

Add desired shell size Add desired finish suffix†
 "1" designates bright cadmium with clear chromate
 "3" designates olive drab cadmium
 "5" designates Alumilite®

Not for use with jam nut style connectors.

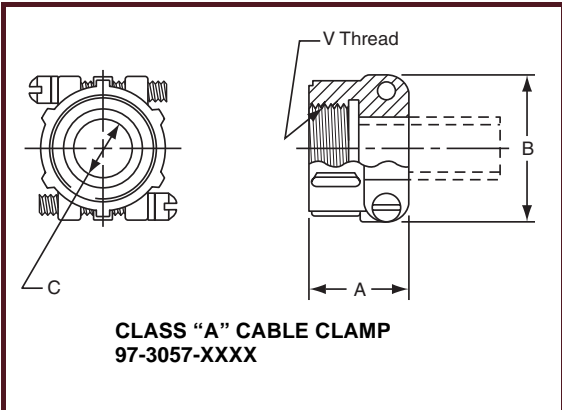

CLASS "A" CABLE CLAMPS – FOR PT, SP, PC

Shell Size	Amphenol® Part Number	A ±.031	B Max.	C Dia. Min.	V Thread
10	97-3057-1004	.795	.842	.3125	.6250-24
12	97-3057-1007	.850	.995	.4375	.7500-20
14	97-3057-1008	.920	1.120	.5625	.8750-20
16	97-3057-1010	.920	1.216	.6250	1.0000-20
18/20	97-3057-1012	.927	1.403	.7500	1.1875-18
22/24	97-3057-1016	1.015	1.683	.9375	1.4375-18

How to Order: Order by 97-3057-XXXX number listed above. Standard finish is olive drab zinc alloy. Consult Amphenol, Sidney, NY for alternate finishes.

† Standard accessory finishes are "1" bright cadmium with clear chromate for PC types, "3" olive drab cadmium for PT and MS/PT types, "5" Alumilite® for SP types. Electroless nickel plating is also available on some items; consult Amphenol, Sidney, NY

All dimensions for reference only.

ACCESSORIES & TOOLS

PT, SP, MS/PT accessories – protection caps

**RECEPTACLE PROTECTION CAP
FOR PT, SP, MS/PT CONNECTORS**

10-101960-XXX **10-101961-XXX** **10-101964-XXX**
MS3181-XXX **(Cable Connecting** **MS3181-XXX**
(Wall Receptacle) **Receptacle)** **(Jam Nut Receptacle)**

RECEPTACLE PROTECTION CAPS – FOR PT, SP, MS/PT

Shell Size	B Dia. +.010 -.000	C Dia. +.010 -.000	G Dia. Max.	L +.020 -.000	X Std. & MS RA, CA, NA	X MS only RAL/CAL/NAL
6	.328	.454	.577	.563	3.000	5.000
8	.454	.578	.706	.563	3.000	5.000
10	.578	.703	.816	.563	3.000	5.000
12	.703	.891	1.000	.563	3.500	5.000
14	.844	1.016	1.128	.563	3.500	5.000
16	.969	1.141	1.257	.563	3.500	5.000
18	1.094	1.266	1.367	.563	3.500	5.000
20	1.219	1.391	1.496	.563	4.000	5.000
22	1.343	1.516	1.624	.563	4.000	5.000
24	1.453	1.614	1.747	.603	4.000	5.000

How to Order Proprietary Receptacle Caps:

Wall Receptacle Caps: 10-101960- XX X
 Cable Connecting Receptacle Caps: 10-101961- XX X
 Jam Nut Receptacle Caps: 10-101964- XX X

Add desired shell size _____
 Add desired finish suffix†

“1” designates bright cadmium with clear chromate
 “3” designates olive drab cadmium
 “5” designates Alumilite®

Proprietary caps are supplied with standard bead chains only (as shown in drawing at left). For other chain options, an MS version cap should be ordered.

How to Order MS Version Receptacle Caps:

Wall Receptacle Caps: MS3181- XX -CA for sash chain
 -CAL for long sash chain
 -RA for rope chain
 -RAL for long rope chain
 Jam Nut Recept. Caps: MS3181- XX -NA for sash chain
 -NAL for long sash chain

Shell size _____

MS versions are supplied with standard anodize finish only. For other finish options a proprietary cap should be ordered.

**PLUG PROTECTION CAP
FOR PT, SP, MS/PT CONNECTORS**
MS3180-XXX
10-101957-XXX

PLUG PROTECTION CAPS – FOR PT, SP, MS/PT

Shell Size	N Dia. +.001 -.005	L Dia. +.025 -.015	X Std. & MS CA, RA	X MS only CAL/RAL
6	.348	.532	3.000	5.000
8	.473	.532	3.000	5.000
10	.590	.532	3.000	5.000
12	.750	.532	3.500	5.000
14	.875	.532	3.500	5.000
16	1.000	.532	3.500	5.000
18	1.125	.532	3.500	5.000
20	1.250	.594	4.000	5.000
22	1.375	.594	4.000	5.000
24	1.500	.627	4.000	5.000

How to Order Proprietary Plug Caps: 10-101957-XX X

Add desired shell size _____

Add desired finish suffix†
 “1” designates bright cadmium with clear chromate
 “3” designates olive drab cadmium
 “5” designates Alumilite®

Proprietary caps are supplied with standard bead chains only (as shown in drawing at left). For other chain options an MS version cap should be ordered.

How to Order MS Version Plug Caps: MS3180- XX

Shell size _____
 -CA for sash chain
 -CAL for long sash chain
 -RA for rope chain
 -RAL for long rope chain

† Standard accessory finishes are “1” bright cadmium with clear chromate for PC types, “3” olive drab cadmium for PT and MS/PT types, “5” Alumilite® for SP types. Electroless nickel plating is also available on some items; consult Amphenol, Sidney, NY

All dimensions for reference only.

PC

accessories – protection caps

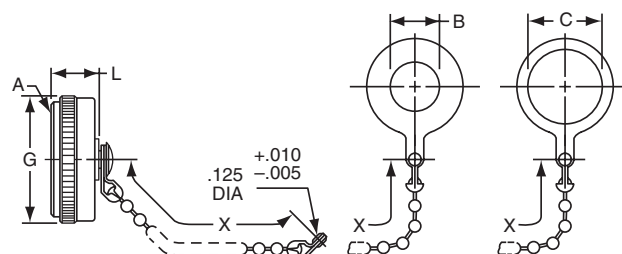

**RECEPTACLE PROTECTION CAP
FOR PC CONNECTORS**

10-101950-XXX **10-101951-XXX** **10-101956-XXX**
(Wall Receptacle) **(Cable Connecting Receptacle)** **(Jam Nut Receptacle)**

RECEPTACLE PROTECTION CAPS – FOR PC

Shell Size	A Thread Class 2B	B Dia. +.010 - .000	C Dia. +.010 - .000	G Max.	L Max.	X ±.250
6	.3750 DS	.328	.454	.520	.448	3.000
8	.5000 DS	.454	.578	.648	.448	3.000
10	.6250 DS	.578	.703	.776	.448	3.000
12	.7500 DS	.703	.891	.902	.448	3.500
14	.8750 DS	.844	1.016	1.030	.448	3.500
16	1.0000 DS	.969	1.141	1.157	.448	3.500
18	1.1250 DS	1.094	1.266	1.284	.448	3.500
20	1.2500 DS	1.219	1.391	1.412	.448	4.000
22	1.3750 DS	1.343	1.516	1.507	.448	4.000

How to Order Proprietary Receptacle Caps for PC connectors only:

Wall Receptacle Caps: 10-101950- XX X

Cable Connecting Receptacle Caps: 10-101951- XX X

Jam Nut Receptacle Caps: 10-101956- XX X

Add desired shell size _____

Add desired finish suffix† _____

“1” designates bright cadmium with clear chromate (standard for PC)

“3” designates olive drab cadmium

“5” designates Alumilite®

Caps for PC connectors are supplied only in proprietary versions with standard bead chains only (as shown in drawing at left).

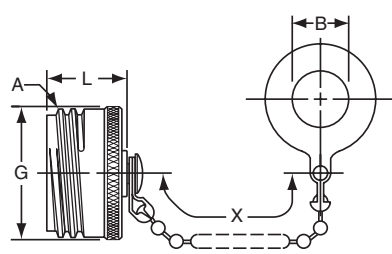

**PLUG PROTECTION CAP
FOR PC CONNECTORS**
10-101955-XXX

PLUG PROTECTION CAPS – FOR PC

Shell Size	A Thread Class 2A	B +.010 - .000	G Max.	L Max.	X ±.250
6	.3750 DS	.328	.399	.557	3.000
8	.5000 DS	.454	.526	.557	3.000
10	.6250 DS	.578	.643	.557	3.000
12	.7500 DS	.703	.770	.557	3.500
14	.8750 DS	.844	.897	.557	3.500
16	1.0000 DS	.969	1.025	.557	3.500
18	1.250 DS	1.094	1.152	.557	3.500
20	1.2500 DS	1.219	1.279	.557	4.000
22	1.3750 DS	1.343	1.416	.557	4.000

How to Order Proprietary Plug Caps for PC only: 10-101955-XX X

Add desired shell size _____

Add desired finish suffix† _____

“1” designates bright cadmium with clear chromate (standard for PC)

“3” designates olive drab cadmium

“5” designates Alumilite®

Caps for PC connectors are supplied only in proprietary versions with standard bead chains only (as shown in drawing at left).

† Standard accessory finishes are “1” bright cadmium with clear chromate for PC types, “3” olive drab cadmium for PT and MS/PT types, “5” Alumilite® for SP types. Electroless nickel plating is also available on some items; consult Amphe-nol, Sidney, NY

All dimensions for reference only.

PT, SP, PC

accessories – dummy receptacles, “O” rings, plastic dust caps

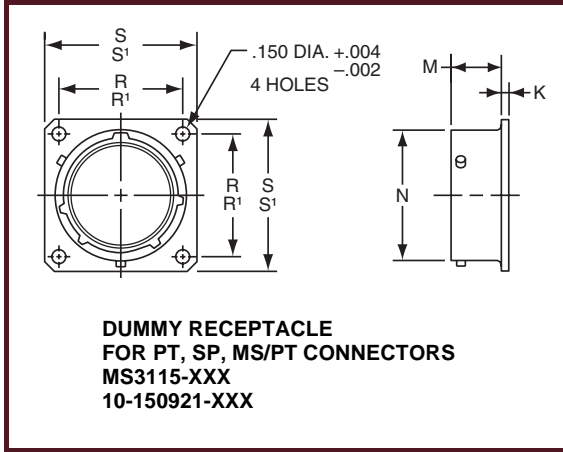

DUMMY RECEPTACLES – FOR PT, SP, MS/PT

Shell Size	K ±.010	M +.030 -.000	N +.001 -.005	Proprietary Version		MS Version	
				R ±.005	S ±.010	R ¹ (TP)	S ¹ (TP)
8	.062	.462	.473	.734	1.047	.594	.828
10	.062	.462	.590	.812	1.125	.719	.954
12	.062	.462	.750	.938	1.250	.812	1.047
14	.062	.462	.875	1.031	1.344	.906	1.141
16	.062	.462	1.000	1.125	1.438	.969	1.234
18	.062	.462	1.125	1.203	1.516	1.062	1.328
20	.062	.556	1.250	1.297	1.672	1.156	1.453
22	.062	.556	1.375	1.375	1.750	1.250	1.578
24	.062	.589	1.500	1.500	1.875	1.375	1.703

How to Order Proprietary Dummy Receptacles: 10-150921-XX X

Add desired shell size _____

Add desired finish suffix[†] _____

"1" designates bright cadmium with clear chromate

"3" designates olive drab cadmium

"5" designates Alumilite[®]

How to Order MS Version Dummy Receptacles: MS3115-XX X

Add desired shell size _____

Add desired finish suffix[†] _____

-A designates Alumilite[®]

-L designates electroless nickel

-W designates olive drab cadmium

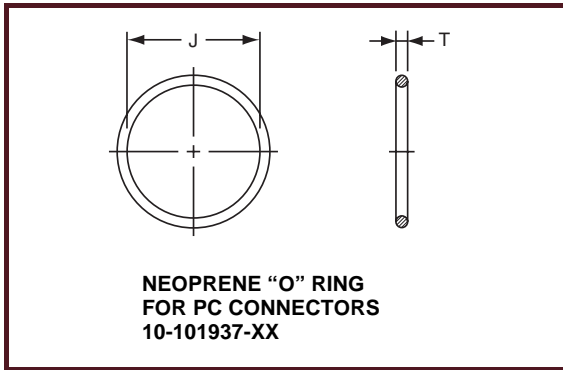

NEOPRENE "O" RINGS – FOR PC

Shell Size	Amphenol [®] Part Number	J Dia. ±.010	T Dia. ±.003
6	10-101937-6	.172	.031
8	10-101937-8	.328	.031
10	10-101937-10	.406	.031
12	10-101937-12	.531	.031
14	10-101937-14	.641	.031
16	10-101937-16	.781	.031
18	10-101937-18	.906	.031
20	10-101937-20	.984	.031
22	10-101937-22	1.109	.031

How to order "O" rings: Order by 10- (Proprietary) only as shown in chart above.

PLASTIC DUST CAPS

FOR PT, SP

Shell Size	Plug Plastic Dust Cap	Receptacle Plastic Dust Cap
6	10-70500-8	10-70506-8S
8	10-70506-12	10-70506-10
10	10-70500-12	10-70506-12
12	10-70506-16	10-70506-14
14	10-70506-18	10-70506-16
16	10-70506-20	10-70506-18
18	10-70506-22	10-70506-20
20	10-70506-24	10-79506-22
22	10-70524-1	10-70506-24
24	10-70506-28	10-70524-1

FOR PC

Shell Size	Plug Plastic Dust Cap	Receptacle Plastic Dust Cap
6	10-70576-6	10-70576-8
8	10-70576-8	10-70500-8
10	10-70500-8	10-70500-10
12	10-70500-10	10-70500-12
14	10-70500-12	10-70500-14
16	10-70500-14	10-70500-16
18	10-70576-18	10-70500-18
20	10-70576-20	10-70500-20
22	10-70576-22	10-70500-22

How to Order Plastic Dust Caps:

To the basic order number add the dust cap size to match connector plug or receptacle shell size, as shown in the tables above.

Example: 10-70506-12 would be the correct order number for a plastic dust cap for a PT00 receptacle, shell size 10.

All dimensions for reference only.

Application Tools

“SE”, “CE”

The following data includes information pertaining to the application tools for crimping, inserting and removing size 20, 16, and 12 contacts incorporated in Amphenol® Miniature Cylindrical Connectors.

All crimping tools included are the “full cycling” type, and when used as specified by the manufacturer, provide reliable crimped wire to contact termination.

Tool frames and turret heads are available from approved tool manufacturers; consult Amphenol, Sidney, NY for listings.

Assembly instructions are available online at www.amphenol-aerospace.com

See the following:

L-786 for SE assembly instructions

L-658 for CE assembly instructions

L-555 for solder type instructions

CRIMPING TOOLS

FOR PT-SE, SP-SE, PC-SE, MS/PT-SE (MIL-C-26482, Series 1) Connectors

Contact Size	MS Tool Part Number	
	Tool Frame	Turret Head
20	M22520/1-01	M22520/1-02
16	M22520/1-01	M22520/1-02
12	M22520/1-01	M22520/1-02

FOR PT-CE, SP-CE, PC-CE (Proprietary) Connectors

Contact Size	MS Tool Part Number	
	Tool Frame	Turret Head
20	M22520/1-01*	*
16	M22520/1-01*	*

* Use Daniels TH254 or equivalent

INSERTION/REMOVAL TOOLS

FOR PT-SE, SP-SE, PC-SE, MS/PT-SE (MIL-C-26482, Series 1) Connectors

Contact Size	Insertion Tool			Removal Tool	
	Amphenol® Contact Insertion Pliers	Amphenol® Contact Insertion Tool	MS Part Number Contact Insertion Tool	Amphenol® Contact Removal Tool	MS Part Number Contact Removal Tool
20	11-8107-20	11-7401-20	M81969/17-03	11-7880-20	M81969/19-07
16	11-8107-16	11-7401-16	M81969/17-04	11-7880-16	M81969/19-08
12	–	–	M81969/17-05	–	M81969/19-09

FOR PT-CE, SP-CE, PC-CE (Proprietary) Connectors

Contact Size	Insertion/Removal Tool	
	Contact Insertion Pliers	Contact Removal Tool Kit
20	11-6782	11-6900
16	11-6781	11-6900

Contacts - Power and Thermocouple Crimp for miniature cylindrical connectors

The following tables provide part number information for crimp contacts used in Amphenol® Miniature Cylindrical Connectors. For additional information, consult Amphenol, Sidney, NY.

CRIMP CONTACTS for MIL-C-26482, Series 1 (PT-SE, SP-SE) Connectors

Contact Size	Accommodates Wire Size	Pins		Sockets	
		MS Number	Amphenol® Proprietary Number	MS Number	Amphenol® Proprietary Number
20	20, 22 & 24 AWG	M39029/31-240	10-314980-20P	M39029/32-259	LP-597820-355
16	16, 18 & 20 AWG	M39029/31-228	10-314980-16P	M39029/32-247	10-257982-16F
12	12 & 14 AWG	M39029/31-235	10-807100-125	M39029/32-254	10-807103-125
20-16	16 AWG		10-330930-20F		10-807155-205
16-20	20 AWG		10-330932-16F		10-330933-16F
12-10	12 AWG		10-330938-12F		10-330939-12F

CRIMP CONTACTS for PT-CE (Proprietary) Connectors

Contact Size	Accommodates Wire Size	Pins	Sockets
		Amphenol® Proprietary Number	Amphenol® Proprietary Number
20	20, 22 & 24 AWG	10-189000-20F	10-597817-351
20-16	16 AWG	10-195962-20F	10-195963-20F
16	16, 18 & 20 AWG	10-189004-16F	10-189006-16F

THERMOCOUPLE CONTACTS for Miniature Connectors

Size	Material	Pins Proprietary Part Number		Sockets Proprietary Part Number	
		CE	SE	CE	SE
16 Crimp Termination	Chromel	10-252900-21P	10-330940-21P	10-252900-21S	10-330940-21S
	Alumel	10-252900-22P	10-330940-22P	10-252900-22S	10-330940-22S
	Iron				
	Constantan				
20 Crimp Termination	Chromel	10-252900-1P	10-330940-1P	10-252900-1S	10-330940-1S
	Alumel	10-252900-2P	10-330940-2P	10-252900-2S	10-330940-2S
	Iron	10-252900-3P	10-330940-3P	10-252900-3S	10-330940-3S
	Constantan	10-252900-4P	10-330940-4P	10-252900-4S	10-330940-4S
20 Solder Termination††	Chromel	10-314910-1P		10-314910-1S	
	Alumel	10-314910-2P		10-314910-2S	
	Iron	10-314910-3P		10-314910-3S	
	Constantan	10-314910-4P		10-314910-4S	

†† Listed are insertable/removable contacts; however, it is intended that contacts be terminated with solder. For additional thermocouple contact information, consult Amphenol, Sidney, NY.

See L-776 for thermocouple contact termination instructions. These are online at www.amphenol-aerospace.com

For PCB contacts for miniature connectors, see page 20.

Coaxial Contacts

for miniature cylindrical connectors

Amphenol® Miniature Connectors can incorporate shielded coax contacts. The Miniature family is built around MIL-C-26482 specifications, with Mil-approved and proprietary styles offered. Normal operating voltage for Miniature cylindricals with power only contacts is up to 1,000 VAC (RMS) at sea level.

Miniature Cylindricals offer these features for contact termination flexibility:

- Several insert arrangements that can incorporate:
 - Size 8 & 12 Crimp Coax contacts for Crimp type
 - Size 8 & 12 Solder Coax contacts for Solder type
- Wide selection of connector shell styles and sizes
- Standard power contact options within the various connector styles include: solder type, crimp front release, crimp rear release
- Coax contacts are designed to the same high performance standards as power contacts. Coax and power contacts may be intermixed with no degradation of connector reliability.
- No mis-mating or cross-plugging with insert rotation and keyway polarization.

GENERAL ORDERING INFORMATION

Amphenol Miniature Cylindricals are normally supplied with a full complement of power contacts, separately packaged. Coax contacts are ordered by part number as referenced in the part number charts on the following pages of this catalog, and are substituted for the power contacts at the time of the cable or equipment assembly. If the application is for coax only, the connector may be ordered *less contacts* and no power contacts will be supplied.

Installation instructions for the coax contacts for Miniature Connectors are provided in Amphenol documents as follows: L-633 for solder type; L-613 for SE type; L-660 for CE type.

HOW TO ORDER:

- A. Select the coax contacts designed for the cable being used from the applicable charts in this catalog for each Miniature type (solder, SE or CE).
- B. Select a connector insert from those shown on pages 60-63 which will accommodate the quantity and size of coaxial contacts needed plus any power contacts required. Note: Size 8S and 12S contacts are used with connector inserts through shell size 18 only. For larger connector shell sizes, use size 8L contacts.
- C. Determine the Miniature Cylindrical type, shell style, finish, service class and insert rotation required for your application.
- D. Consult Amphenol, Sidney NY with the pertinent cable, contact, insert arrangement and connector style choices for complete connector part number.

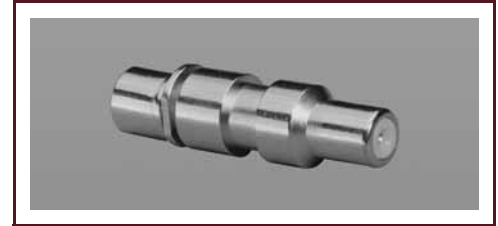

Solder Coax Contact
for use in Miniature Solder Type Connectors



Pin Crimp Coax Contact
for use in Miniature Crimp SE Type Connectors



Socket Crimp Coax Contact
for use in Miniature Crimp SE Type Connectors

Coaxial Contacts

for miniature cylindrical connectors, cont.

Amphenol® Coaxial Contacts designed for use in Miniature Cylindrical Connectors offer the same durability advantages and design benefits for reliable interconnection as the Amphenol coax contacts used in high performance D38999 connectors. A variety of military and commercial shielded cables are accommodated within the miniature cylindrical series. Amphenol supplies coax contacts for solder, crimp SE and crimp CE connector styles.

Other features of the coax for miniature cylindricals include:

- Miniature coax design has an outside nut within the assembly for fast, reliable assembly of contact to cable.
- All types feature solder style inner contacts and crimp style outer contacts for reliable cable termination
- Miniature coax crimp type contacts are designed for use in Miniature crimp series connectors
- Miniature coax solder type contacts are designed for use in Miniature solder series connectors. These come pre-installed into the solder connector.

TYPICAL MINIATURE CRIMP COAX SOCKET CONTACT has crimp socket outer contact with a solder pin inner contact

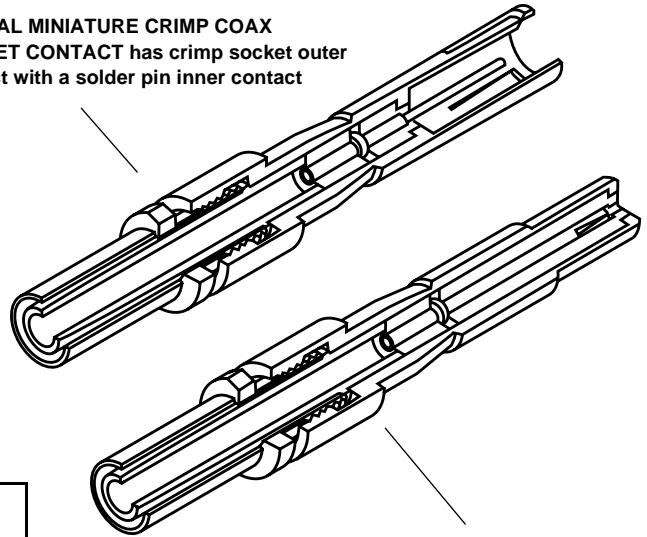

TYPICAL MINIATURE CRIMP COAX PIN CONTACT has crimp pin outer contact with a solder socket inner contact

TYPICAL ELECTRICAL PERFORMANCE

Size 8 and 12 Coax Contacts

Contact Resistance:

Center @ 1 Amp, 170 millivolts max. voltage drop @ 25°C
 Outer @ 12 Amps, 150 millivolts max. voltage drop @ 25°C

Dielectric Withstanding Voltage:

Size 8: 1,300 VAC Rms @ sea level
 Size 12: 1,000 VAC Rms @ sea level
 Size 8 & 12: 250 VAC Rms @ 50,000 ft.

Insulation Resistance

5,000 megohms minimum @ 25°C

Typical VSWR for size 8 & 12 PT-SE Types II & III only:

1.2 + .12F (GHz) up to 10 GHz

EXPLANATION OF TYPE CLASSIFICATIONS:

PT-SE Type I is moisture seal design with internal O-ring.

PT-SE Type II is 50 ohm impedance matched version. Contacts terminated to other than 50 ohm cables are therefore not matched.

PT-SE Type III is 50 ohm contact, non-serviceable after assembly

Solder and CE Types are non-impedance matched contacts.

CONTACT FINISHES:

Suffix Finish

1	0.00020 min. silver over copper flash
2	0.00005 min. gold (Knoop hardness 130-200) over silver
3	0.00010 min. gold (Knoop hardness 130-200) over silver
4	0.00010 min. gold (Knoop hardness 130-200) over copper
5	0.00005 min. gold (Knoop hardness 130-200) over nickel
E	0.00005 min. gold (Knoop hardness 90 max.) over copper
F	0.00005 min. gold (Knoop hardness 130-200) over copper
H	0.00010 min. gold (Knoop hardness 130-200) over copper

Coaxial Contacts

for miniature cylindrical connectors, cont.
solder (MIL-C-26482 Series 1 type) - application data

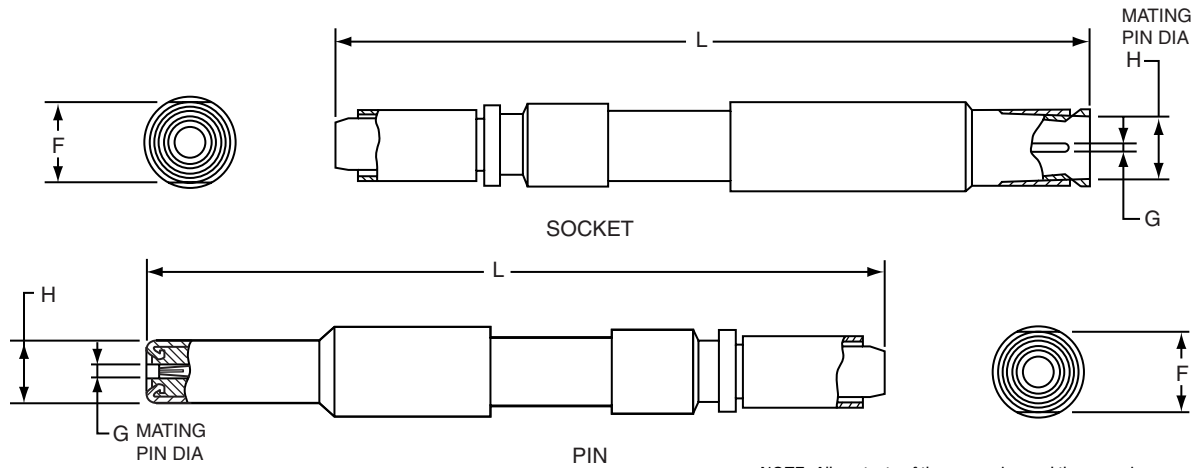

NOTE: All contacts of the same size and the same inner and outer contact diameters (G & H) will mate with each other.

SOLDER COAX CONTACTS												
For use in Miniature Solder Type Connectors: PT, SP, MS/PT and PC Styles												
Cable	Contact Part Number		Contact Size	Dimensional Data (See Drawings above)					Crimp Ferrule Tools			Retainer Nut Wrench
				G Dia.	H Dia. ±0.001	F Across Flats ±0.004	L Length Ref.		MIL-T-22910/7-1 Tool Use with Die Part Number	MIL-C-22520/5-01 Tool Use with Die Part Number	MIL-C-22520/10-01 Tool Use with Die Part Number	
	Pin	Socket										
RG-58C/U, RG-141A/U, RG-303/U	21-33020-2	21-33019-2	8S	0.040 ± 0.001	0.219	0.280	1.114	1.115	M22910/7-15 (B)	M22520/5-05 (B) M22520/5-41 (B)	M22520/10-07 (B)	11-8676-2
RG-59B/U, RG-62A/U, RG-62B/U, RG-210/U	21-33020-1	21-33019-1	8L	0.040 ± 0.001	0.219	0.280	1.176	1.177	M22910/7-18 (B)	M22520/5-45 (B)		11-8676-3
	21-33020-3	21-33019-3	8S	0.040 ± 0.001	0.219	0.280	1.114	1.115				
RG-142B/U, Times M151115	21-33020-7*	21-33019-7*	8S	0.040 ± 0.001	0.219	0.280	1.114	1.115	M22910/7-16 (B)	M22520/5-43 (B)		11-8676-2
RG-161/U, RG-174A/U, RG-179B/U, RG-187A/U, RG-188A/U, RG-316/U	21-33020-32*	21-33019-32*	12S	0.0300 ± 0.0005	0.140	0.172	1.092	1.093	M22910/7-12 (B)	M22520/5-03 (A) M22520/5-08 (A) M22520/5-35 (B)	M22520/10-05 (A)	11-8676-1
RG-178B/U	21-33020-4	21-33019-4*	8S	0.040 ± 0.001	0.219	0.280	1.114	1.115	M22910/7-11 (B)	M22520/5-03 (B) M22520/5-33 (B)	M22520/10-05 (B)	11-8676-2
RG-196A/U	21-33020-31†	21-33061-31†	12S	0.0300 ± 0.0005	0.140	0.172	1.092	1.093	M22910/7-11 (B)	M22520/5-03 (B) M22520/5-33 (B)	M22520/10-05 (B)	11-8676-1
RG-180B/U, RG-195A/U, Raychem 5022D1312-9	21-33020-5*	21-33019-5*	8S	0.040 ± 0.001	0.219	0.280	1.114	1.115	M22910/7-15 (B)	M22520/5-05 (B) M22520/5-41 (B)	M22520/10-07 (B)	11-8676-2
Raychem 5021D1331-9	21-33020-6*	21-33019-6*	8S	0.040 ± 0.001	0.219	0.280	1.114	1.115	M22910/7-15 (B)	M22520/5-05 (B) M22520/5-41 (B)	M22520/10-07 (B)	11-8676-2
Thermatics 2929-29	21-33020-33	21-33061-33	12S	0.0200 ± 0.0005	0.140	0.172	1.092	1.093	M22910/7-13 (B)	M22520/5-37 (B)		11-8676-1

NOTE: Contacts can be ordered by part numbers given in chart

NOTE: Size 8S and 12S contacts are used with connector inserts through shell size 18 only. For larger connector shell sizes, use size 8L contacts.

CONTACT FINISH: For all contacts in this series feature 0.000050 minimum gold (Knoop hardness 130-200).

* Consult Amphenol, Sidney NY for availability

CRIMPING TOOLS: Italicized letters in parenthesis that follow positioner part numbers indicate applicable die closure. Commercial equivalents with the same die closure dimension may be used.

† 21-33020-31 and 21-33061-31 only mate with each other

Coaxial Contacts

for miniature cylindrical connectors, cont.
crimp SE (MIL-C-26482 Series 1 type) - application data

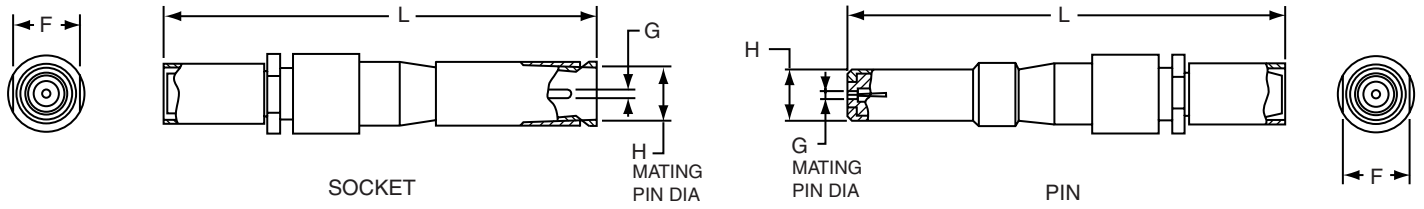

NOTE: All contacts of the same size and the same inner and outer contact diameters (G & H) will mate with each other.

SE CRIMP COAX CONTACTS																
For use in Miniature Crimp Type Connectors: PT-SE, SP-SE, MS/PT-SE and PC-SE Styles																
Cable	Contact Part Number		Contact Size	Type (See Pg. 23)	Finish on Mating Parts (See Pg. 23)	Dimensional Data (See Drawings above)				Crimp Ferrule Tools			Retainer Nut Wrench	Installation Tools		
	Pin	Socket				G Dia.	H Dia. ±0.001	F Across Flats ±0.004	L Length Ref.		MIL-T-22910/7-1 Tool Use with Die Part Number	MIL-C-22520/5-01 Tool Use with Die Part Number		MIL-C-22520/10-0 Tool Use with Die Part Number	Insertion	Removal
									Pin	Socket						
RG-55B/U, RG-142A/U, RG-142B/U, RG-223/U	21-33012-21 21-33012-25	21-33011-21 21-33011-25	8 8	I II	2	0.0355 ±0.0010	0.218	0.280	1.156	1.144	M22910/7-17 (B)	M22520/5-05 (A) M22520/5-19 (B)	M22520/10-07 (A)	11-8676-2	11-8369-5	11-7880-8
	21-33038-21 21-33038-25*	21-33037-21 21-33037-25	8 8	I II	4										11-8369-5	11-8154-1
	21-33138-21(*) 21-33138-25(*)	21-33137-21(*) 21-33137-25(*)	8 8	I II	**											
RG-58C/U, RG-141A/U, RG-303/U	21-33012-22 21-33012-26	21-33011-22 21-33011-26	8 8	I II	2	0.0355 ±0.0010	0.218	0.280	1.156	1.144	M22910/7-15 (B)	M22520/5-05 (B) M22520/5-41 (B)	M22520/10-07 (B)	11-8676-2	11-8369-4	11-7880-8
	21-33038-22* 21-33038-26*	21-33037-22 21-33037-26*	8 8	I II	4										11-8369-4	11-8154-1
	21-33138-22(*) 21-33138-26(*)	21-33137-22(*) 21-33137-26(*)	8 8	I II	**											
RG-59B/U, RG-62A/U, RG-62B/U, RG-210/U	21-33012-36 21-33038-36*	21-33011-36 21-33037-36	8 8	II II	2 4	0.0355 ±0.0010	0.218	0.280	1.156	1.144	M22910/7-18 (B)	M22520/5-45 (B)	11-8676-3	11-8369-5	11-7880-8	
	21-33138-36(*)	21-33137-36(*)	8	II	**									11-8660-5	11-8154-1	
	21-33012-37* 21-33038-37*	21-33011-37* 21-33037-37*	8 8	II II	2 4									11-8369-5	11-7880-8	
RG-140/U, RG-302/U	21-33012-37* 21-33038-37*	21-33011-37* 21-33037-37*	8 8	II II	2 4	0.0355 ±0.0010	0.218	0.280	1.156	1.144	M22910/7-17 (B)	M22520/5-05 (A) M22520/5-19 (B)	M22520/10-07 (A)	11-8676-2	11-8369-5	11-7880-8
	21-33138-37(*)	21-33137-37(*)	8	II	**										11-8660-5	11-8154-1
	21-33012-34 21-33012-30	21-33011-34 21-33011-30	8 8	I II	2											
RG-161/U, RG-174A/U, RG-179B/U, RG-187A/U, RG-188A/U, RG-316/U	21-33038-34 21-33038-30	21-33037-34 21-33037-30	8 8	I II	4	0.0355 ±0.0010	0.218	0.280	1.156	1.144	M22910/7-12 (B)	M22520/5-03 (A) M22520/5-08 (A) M22520/5-35 (B)	M22520/10-05 (A)	11-8676-2		11-7880-8
	21-33138-34(*) 21-33138-30(*)	21-33137-34(*) 21-33137-30(*)	8 8	I II	**										11-8369-2	11-8154-1
	21-33012-1 21-33012-4	21-33011-1 21-33011-4	12 12	I II	2											
	21-33038-1* 21-33038-4	21-33037-1* 21-33037-4*	12 12	I II	4	0.0200 ±0.0005	0.128	0.172	1.092	1.072	11-8676-1		11-7880-12			
	21-33138-1(*) 21-33138-4(*)	21-33137-1(*) 21-33137-4(*)	12 12	I II	**							11-8154-2				
	21-33012-35 21-33038-35	21-33011-35 21-33037-35	8 8	I I	2 4											
RG-178B/U, RG-196A/U	21-33012-35 21-33038-35	21-33011-35 21-33037-35	8 8	I I	2 4	0.0355 ±0.0010	0.218	0.280	1.156	1.144	M22910/7-11 (B)	M22520/5-03 (B) M22520/5-33 (B)	M22520/10-05 (A)	11-8676-2		11-7880-8
	21-33138-35(*)	21-33137-35(*)	8	I	**										11-8369-2	11-8154-1
	21-33012-3* 21-33012-5	21-33011-3* 21-33011-5	12 12	I II	2											
	21-33038-3* 21-33038-5	21-33037-3* 21-33037-5*	12 12	I II	4	0.0200 ±0.0005	0.128	0.172	1.092	1.072	11-8676-1		11-7880-12			
	21-33138-3(*) 21-33138-5(*)	21-33137-3(*) 21-33137-5(*)	12 12	I II	**							11-8154-2				

NOTE: Contacts can be ordered by part numbers given in chart

** See finish options for SE crimp Miniature contacts listed on page 70. Replace the parenthesis of the contact part number with the finish suffix number. However, you should consult Amphenol, Sidney, NY regarding the availability of all finish choices for each part.

* Consult Amphenol, Sidney NY for availability

CRIMPING TOOLS: Italicized letters in parenthesis that follow positioner part numbers indicate applicable die closure. Commercial equivalents with the same die closure dimension may be used.

Coaxial Contacts

for miniature cylindrical connectors, cont.
crimp SE (MIL-C-26482 Series 1 type) - application data, cont.

NOTE: All contacts of the same size and the same inner and outer contact diameters (G & H) will mate with each other.

SE CRIMP COAX CONTACTS																
For use in Miniature Crimp Type Connectors: PT-SE, SP-SE, MS/PT-SE and PC-SE Styles																
Cable	Contact Part Number		Contact Size	Type (See Pg. 23)	Finish on Mating Parts (See Pg. 23)	Dimensional Data (See Drawings pg. 25)				Crimp Ferrule Tools			Retainer Nut Wrench	Installation Tools		
						G Dia.	H Dia. ±0.001	F Across Flats ±0.004	L Length Ref.		MIL-T-22910/7-1 Tool Use with Die Part Number	MIL-C-22520/5-01 Tool Use with Die Part Number		MIL-C-22520/10-0 Tool Use with Die Part Number	Insertion	Removal
	Pin	Socket							Pin	Socket						
RG-180B/U, RG-195A/U	21-33012-24	21-33011-24	8	I	2	0.0355 ± 0.0010	0.218	0.280	1.156	1.144	M22520/7-15 (B)	M22520/5-05 (B) M22520/5-41 (B)	M22520/10-07 (B)	11-8676-2	11-8369-4 11-8660-4	11-7880-8 11-8154-1
	21-33012-46*	21-33011-46*	8	II	4											
	21-33038-24 21-33038-46*	21-33037-24 21-33037-46*	8	I II	4											
Raychem 9527E1118, RG-180B/U, RG-195A/U	21-33138-24(*)	21-33137-24(*)	8	I	**	0.0200 ± 0.0005	0.128		0.899	0.879	Daniels GS200 Tool with G2P330 or M22520/31-01 Tool with Positioner M22520/31-02			11-8674-12	11-7880-12 11-8154-2	
	21-33138-46(*)	21-33137-46(*)	8	II	**											
RG-188 or RG-316 Double Braid	21-33012-6*	21-33011-6*	12	I	2	0.0200 ± 0.0005	0.128	0.172	1.092	1.072	M22910/7-13 (B)	M22520/5-37 (B)		11-8676-1	11-8369-2 11-8660-2	11-7880-12 11-8154-2
	21-33038-6*	21-33037-6*	12	I	4											
	21-33038-7*	21-33037-7*	12	II	4											
Thermax 50C-25A- DS-1	21-33138-6(*)	21-33137-6(*)	12	I	**	0.0355 ± 0.0010	0.128	0.280	1.156	1.144	M22910/7-13 (B)	M22520/5-37 (B)		11-8676-2	11-8369-4 11-8660-4	11-7880-8 11-8154-1
	21-33138-7(*)	21-33137-7(*)	12	II	**											
	21-33012-44	21-33011-44	8	II	2											
RG-195 Double Braid	21-33038-44*	21-33037-44*	8	II	4	0.0355 ± 0.0010	0.128	0.280	1.156	1.144	M22910/7-16 (B)	M22520/5-43 (B)		11-8676-2	11-8369-4 11-8660-4	11-7880-8 11-8154-1
	21-33138-44(*)	21-33137-44(*)	8	II	**											
	21-33138-28(*)	21-33137-28(*)	8	I	**											
RG-122/U, Raychem 5022E5111	21-33012-23	21-33011-23	8	I	2	0.0355 ± 0.0010	0.218	0.280	1.156	1.144	M22910/7-15 (B)	M22520/5-05 (B) M22520/5-41 (B)	M22520/10-07 (B)	11-8676-2	11-8369-4 11-8660-4	11-7880-8 11-8154-1
	21-33012-27	21-33011-27	8	II	2											
	21-33038-23*	21-33037-23*	8	I	4											
Raychem 9530D5314	21-33138-23(*)	21-33137-23(*)	8	I	**	0.0355 ± 0.0010	0.218	0.280	1.156	1.144	M22910/7-15 (B)	M22520/5-05 (B) M22520/5-41 (B)	M22520/10-07 (B)	11-8676-2	11-8369-4 11-8660-4	11-7880-8 11-8154-1
	21-33138-27(*)	21-33137-27(*)	8	II	**											
	21-33038-27	21-33037-27	8	II	4											
Raychem 9527A1317	21-33138-31(*)	21-33137-31(*)	8	I	**	0.0355 ± 0.0010	0.218	0.280	1.156	1.144	M22910/7-15 (B)	M22520/5-05 (B) M22520/5-41 (B)	M22520/10-07 (B)	11-8676-2	11-8369-4 11-8660-4	11-7880-8 11-8154-1
	21-33012-31	21-33011-31	8	I	2											
	21-33038-31	21-33037-31	8	I	4											
Raychem 7527A1318	21-33138-39(*)	21-33137-39(*)	8	II	**	0.0355 ± 0.0010	0.218	0.280	1.156	1.144	M22910/7-12 (B)	M22520/5-03 (A) M22520/5-08 (A) M22520/5-35 (B)	M22520/10-05 (A)	11-8676-2	11-8369-2 11-8660-2	11-7880-8 11-8154-1
	21-33012-39	21-33011-39	8	II	2											
	21-33038-39*	21-33037-39*	8	II	4											
Westrex 199-49-1, Tensolite 30850/87-T-1	21-33138-40*	21-33137-40(*)	8	II	**	0.0200 ± 0.0005	0.128	0.172	1.092	1.072	M22910/7-11 (B)	M22520/5-03 (B) M22520/5-33 (B)	M22520/10-05 (B)	11-8676-1	11-8369-1 11-8660-1	11-7880-12 11-8154-2
	21-33012-40	21-33011-40	8	II	2											
	21-33038-40*	21-33037-40*	8	II	4											
Westrex 199-49-1, Tensolite 30850/87-T-1	21-33138-43(*)	21-33137-43(*)	12	II	**	0.0200 ± 0.0005	0.128	0.172	1.092	1.072	M22910/7-11 (B)	M22520/5-03 (B) M22520/5-33 (B)	M22520/10-05 (B)	11-8676-1	11-8369-1 11-8660-1	11-7880-12 11-8154-2
	21-33038-43	21-33037-43	12	II	4											

NOTE: Contacts can be ordered by part numbers given in chart

** See finish options for SE crimp Miniature contacts listed on page 70. Replace the parenthesis of the contact part number with the finish suffix number. However, you should consult Amphenol, Sidney, NY regarding the availability of all finish choices for each part number.

* Consult Amphenol, Sidney NY for availability

CRIMPING TOOLS: Italicized letters in parenthesis that follow positioner part numbers indicate applicable die closure. Commercial equivalents with the same die closure dimension may be used.

Coaxial Contacts

for miniature cylindrical connectors, cont.
 crimp CE (MIL-C-26482 Series 1 type) - application data

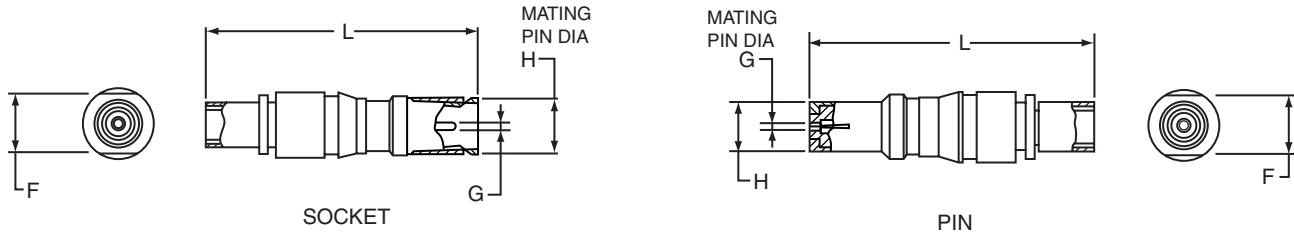

NOTE: All contacts of the same size and the same inner and outer contact diameters (G & H) will mate with each other.

CE CRIMP COAX CONTACTS														
For use in Miniature Crimp Type Connectors: PT-CE, SP-CE and PC-CE Styles														
Cable	Contact Part Number		Contact Size	Dimensional Data (See Drawings above)					Crimp Ferrule Tools			Retainer Nut Wrench	Installation Tools	
				G Dia. ± 0.001	H Dia. ± 0.001	F Across Flats ± 0.004	L Length Ref.		MIL-T-22910/7-1 Tool Use with Die Part Number	MIL-C-22520/5-01 Tool Use with Die Part Number	MIL-C-22520/10-01 Tool Use with Die Part Number		Insertion	Removal
	Pin	Socket												
RG-58C/U, RG-141A/U, RG-303/U	21-33024-1	21-33023-1	8	0.040	0.219	0.280	1.239	1.285	M22910/7-15 (B)	M22520/5-01 (B) M22520/5-41 (B)	M22520/10-07 (B)	11-8676-2	11-8369-4 11-8660-4	11-7310
RG-178B/U, RG-196A/U	21-33024-2	21-33023-2	8	0.040	0.219	0.280	1.039	1.085	M22910/7-11 (B)	M22520/5-03 (B) M22520/5-33 (B)	M22520/10-05 (B)	11-8676-2	11-8369-1 11-8660-1	11-7310

NOTE: Contacts can be ordered by part numbers given in chart

* Consult Amphenol, Sidney NY for availability

CONTACT FINISH: for all contacts in this series feature 0.000050 minimum gold (Knoop hardness 130-200).

CRIMPING TOOLS: Italicized letters in parenthesis that follow positioner part numbers indicate applicable die closure. Commercial equivalents with the same die closure dimension may be used.

Mounting Recommendations for miniature cylindrical connectors

FLANGE MOUNTED CONNECTORS

All flange mounting PC and PT connectors use standard MS mounting dimensions. They cannot be back panel mounted due to coupling clearance. The PTB (thru-bulkhead) type connector must also be back panel mounted on one side. Flange gaskets are available for both series, see page 64.

Shell Size	R (TP)		D Dia.	
	PC & PT	SP	PC & PT	SP
6	.469	.641	.323	.439
8	.594	.734	.449	.563
10	.719	.812	.573	.680
12	.812	.938	.699	.859
14	.906	1.031	.823	.984
16	.969	1.125	.949	1.108
18	1.062	1.203	1.073	1.233
20	1.156	1.297	1.199	1.358
22	1.250	1.375	1.323	1.483
24	1.375	—	1.449	—

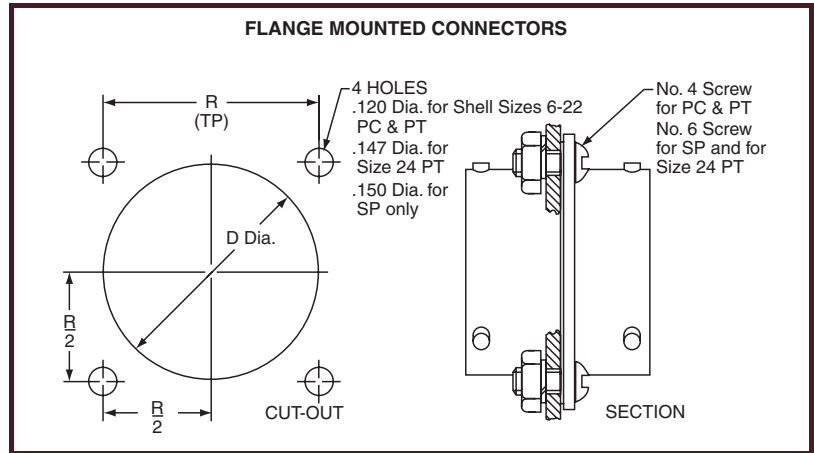

JAM NUT MOUNTINGS

The jam nut design has become very popular because it allows bench wiring of harness assemblies. The labor saving often offsets the added cost of the jam nut receptacle which is due to the self contained "O" ring and the extra nut. The PC series mounts in a round hole and can be pinned to prevent rotation. The PT series mounts in a "D" mounting hole and does not require pinning.

Shell Size	R +.010 -.000	B +.000 -.010	F ±.010	P Panel Thickness	
				Min.	Max.
6	.447	.420	.286	.062	.125
8	.572	.542	.331	.062	.125
10	.697	.669	.375	.062	.125
12	.884	.830	.442	.062	.125
14	1.007	.955	.486	.062	.125
16	1.134	1.084	.530	.062	.125
18	1.259	1.208	.573	.062	.125
20	1.384	1.333	.641	.062	.250
22	1.507	1.459	.685	.062	.250
24	1.634	1.575	—	.062	.250

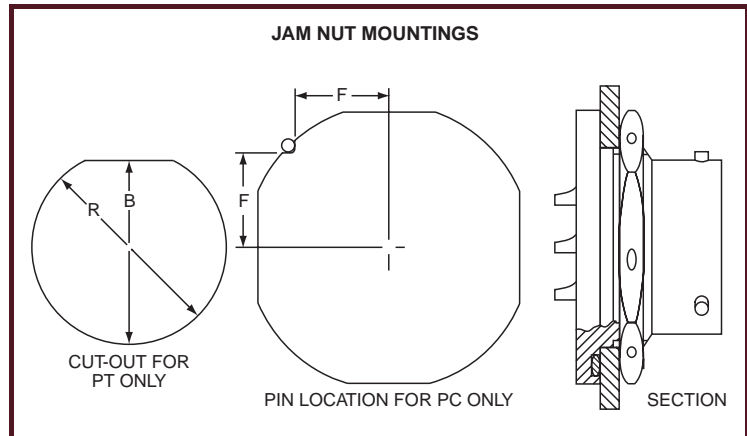

HERMETIC RECEPTACLE MOUNTINGS

This series must be mounted in such a way as to preserve the hermetic seal provided by the glass insert. Mounting data for box and jam nut receptacles is given above. Cut-out required for solder mounting receptacles (N) is given below.

Shell Size	N Max.
6	.458
8	.582
10	.692
12	.801
14	.926
16	1.051
18	1.176
20	1.395
22	1.375

The finish of each of these hermetic receptacles is fused electro-deposited tin for easy solderability, and protected by a special lacquer for optimum shelf life. The lacquer will not interfere with any soldering operation. Low temperature solder should be used and the addition of a solder fillet at arrow points on drawing at right is recommended. Care must be taken that the operating temperature of the final assembly does not rise above the melt-

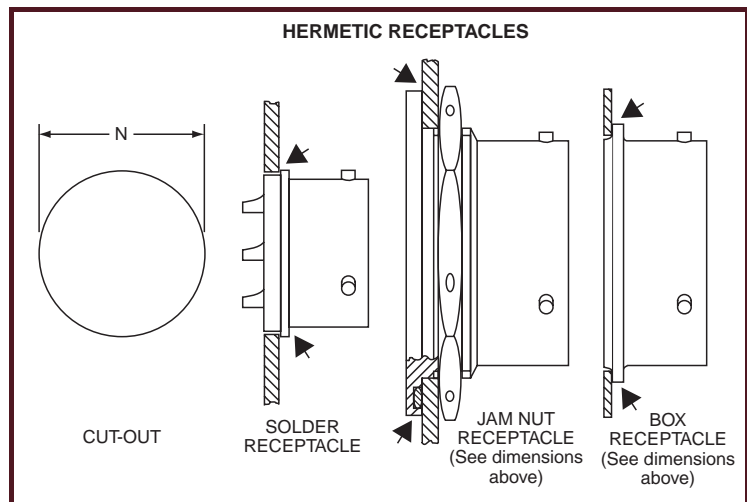

Other Amphenol Miniature Cylindrical Connectors

MIL-C-26482, Series 2

MIL-C-26482, Series 2 connectors are provided with the Amphenol®/Matrix® family of miniature cylindricals. These are bayonet coupling type, and they feature crimp contacts that are rear insertable and rear releasable.

There are six shell styles available and 34 insert arrangements. Military part numbers of the Matrix MIL-C-26482 family include the following:

MS3470 wall mounting receptacle with narrow flange

MS3472 wall mounting receptacle with wide flange

MS3471 cable connecting receptacle

MS3474 jam nut receptacle

MS3476 straight plug

MS3475 plug with RFI grounding fingers

See catalog 12-071 for more information.

Geophysical Miniature Cylindricals

Designed for the Geophysical industry's rugged environments, the Amphenol® Geophysical Series connector has custom features that provide reliability in extreme temperature and moisture conditions.

The unique shell design provides stronger shells along with an anodized (nonconductive) finish for greater salt, corrosion and abrasion resistance. Coupling nuts are manufactured with round detent holes and are sold separately for greater customer flexibility. See product data sheet #146.

RJ Field Bayonet MIL-C-26482 Cylindricals

Amphenol PCD division provides MIL-C-26482 bayonet coupling cylindrical connectors with an RJ45 Ethernet interface*. These are designed for use in all levels of harsh environments from industrial to mil-aero applications providing IP67 protection from dust, fluids, vibration, shock and traction. The Amphenol® RJ Field allows the use of Ethernet Class D/Cat 5 and Cat 5e connections for 10 BaseT, 100 Base TX, or 1000 BaseT networks. It works with any standard RJ45 cordset with no extra tooling. It also offers reinforced EMI protection.

For more information go online to www.rjfield.com or ask for the Field Series brochure.

* Other Field Series products are available through Amphenol PCD. These include RJF TV within MIL-DTL-38999 Series III threaded coupling connectors, and RJF 544 within ECTA push-pull plastic shell coupling.



MIL-C-26482
Series 2



Geophysical
Miniature Cylindricals



RJ Field Bayonet
MIL-C-26482 Cylindricals



Компания «ЭлектроПласт» предлагает заключение долгосрочных отношений при поставках импортных электронных компонентов на взаимовыгодных условиях!

Наши преимущества:

- Оперативные поставки широкого спектра электронных компонентов отечественного и импортного производства напрямую от производителей и с крупнейших мировых складов;
- Поставка более 17-ти миллионов наименований электронных компонентов;
- Поставка сложных, дефицитных, либо снятых с производства позиций;
- Оперативные сроки поставки под заказ (от 5 рабочих дней);
- Экспресс доставка в любую точку России;
- Техническая поддержка проекта, помощь в подборе аналогов, поставка прототипов;
- Система менеджмента качества сертифицирована по Международному стандарту ISO 9001;
- Лицензия ФСБ на осуществление работ с использованием сведений, составляющих государственную тайну;
- Поставка специализированных компонентов (Xilinx, Altera, Analog Devices, Intersil, Interpoint, Microsemi, Aeroflex, Peregrine, Syfer, Eurofarad, Texas Instrument, Miteq, Cobham, E2V, MA-COM, Hittite, Mini-Circuits, General Dynamics и др.);

Помимо этого, одним из направлений компании «ЭлектроПласт» является направление «Источники питания». Мы предлагаем Вам помощь Конструкторского отдела:

- Подбор оптимального решения, техническое обоснование при выборе компонента;
- Подбор аналогов;
- Консультации по применению компонента;
- Поставка образцов и прототипов;
- Техническая поддержка проекта;
- Защита от снятия компонента с производства.



Как с нами связаться

Телефон: 8 (812) 309 58 32 (многоканальный)

Факс: 8 (812) 320-02-42

Электронная почта: org@eplast1.ru

Адрес: 198099, г. Санкт-Петербург, ул. Калинина, дом 2, корпус 4, литера А.