

33 W auxiliary SMPS for refrigerator using ICE5QR1070AZ

REF_5QR1070AZ_33W1

About this document

Scope and purpose

This document is a reference design for a 33 W auxiliary SMPS for a refrigerator with the latest fifth-generation Infineon QR CoolSET™ ICE5QR1070AZ. The power supply is designed with a universal input compatible with most geographic regions and dual isolated outputs (+12 V/2.66 A and +5 V/0.2 A) as typically employed in most home appliances.

Highlights of the auxiliary power supply for a refrigerator:

- High efficiency under light-load conditions to meet ENERGY STAR requirements
- Simplified circuitry with good integration of power and protection features
- Single-layer PCB design for compatibility with wave-soldering process and low-cost manufacturing
- Auto-restart protection scheme to minimize interruption to enhance end-user experience

Intended audience

This document is intended for power supply design or application engineers, etc. who want to design auxiliary power supplies for refrigerators that are efficient under light-load conditions, reliable and easy to design.

Table of contents

About this document	1
Table of contents	1
1 System introduction	3
1.1 High efficiency under light-load conditions to meet ENERGY STAR requirements	4
1.2 Simplified circuitry with good integration of power and protection features.....	4
1.3 Single-layer PCB design for compatibility with the wave-soldering process and low-cost manufacturing ..	4
1.4 Auto-restart protection scheme to minimize interruption to enhance end-user experience.....	4
2 Reference design board	5
3 Power supply specifications	6
4 Circuit diagram	7
5 Circuit description	8
5.1 EMI filtering and line rectification.....	8
5.2 Flyback converter power stage.....	8
5.3 Control of flyback converter through fifth-generation QR CoolSET™ ICE5QR1070AZ	8
5.3.1 Integrated HV power MOSFET	8
5.3.2 Current sensing (CS)	9
5.3.3 Feedback (FB) and compensation network	9
5.4 Unique features of the fifth-generation QR CoolSET™ ICE5QR1070AZ to support the requirements of refrigerator auxiliary power	9
5.4.1 Fast self-start-up and sustaining of V_{CC}	9

System introduction

5.4.2	QR switching with valley sensing.....	9
5.4.3	System robustness and reliability through protection features	9
5.4.3.1	Input voltage monitoring and protection.....	9
5.4.3.2	Other protections with auto restart.....	10
5.5	Clamper circuit	10
5.6	PCB design tips.....	10
5.7	EMI reduction tips.....	11
6	PCB layout.....	13
6.1	Top side.....	13
6.2	Bottom side	13
7	BOM.....	14
8	Transformer specification	16
9	Measurement data and graphs.....	17
9.1	Load regulation	18
9.2	Line regulation.....	19
9.3	Efficiency vs AC-line input voltage.....	20
9.4	Standby power	21
9.5	Maximum input power	21
10	Thermal performance	22
11	Waveforms	23
11.1	Start-up at low/high AC-line input voltage with maximum load.....	23
11.2	Switching waveform at maximum load.....	23
11.3	Switching waveform at 25% load	24
11.4	Output ripple voltage at maximum load	24
11.5	Output ripple voltage in ABM 1 W load	25
11.6	Load transient response (dynamic load from 10% to 100%)	25
11.7	Line OV Protection (OVP) (non-switch auto restart)	26
11.8	Brown-in/Brown-out protection (non-switch auto restart).....	26
11.9	Over-load protection (odd-skip auto restart).....	27
11.10	Output OV protection (odd-skip auto restart).....	27
11.11	Conducted emissions (EN 55022 class B)	28
11.12	ESD immunity (EN 61000-4-2)	30
11.13	Surge immunity (EN 61000-4-5)	30
12	Appendix A: Transformer design and spreadsheet [3]	31
13	Appendix B: WE transformer specification.....	36
14	References.....	39
	Revision history	39

System introduction

1 System introduction

With the growing household trend for internet-connected devices, the new generation of home appliances such as refrigerators are equipped with advanced features which often include communication capability, such as wireless communication, touchscreen display and sensors. These will transform a static product into an interactive and intelligent home appliance, capable of adapting to the smart-home theme. To support this trend, Infineon has introduced the latest fifth-generation QR CoolSET™ to address this need in an efficient and cost-effective manner.

An auxiliary SMPS is needed to power the various modules and sensors, which typically operate from a stable DC voltage source. The Infineon CoolSET™ (as shown in Figure 1) forms the heart of the system, providing the necessary protection and AC/DC conversion from the mains to multiple regulated DC voltages to power the various blocks.

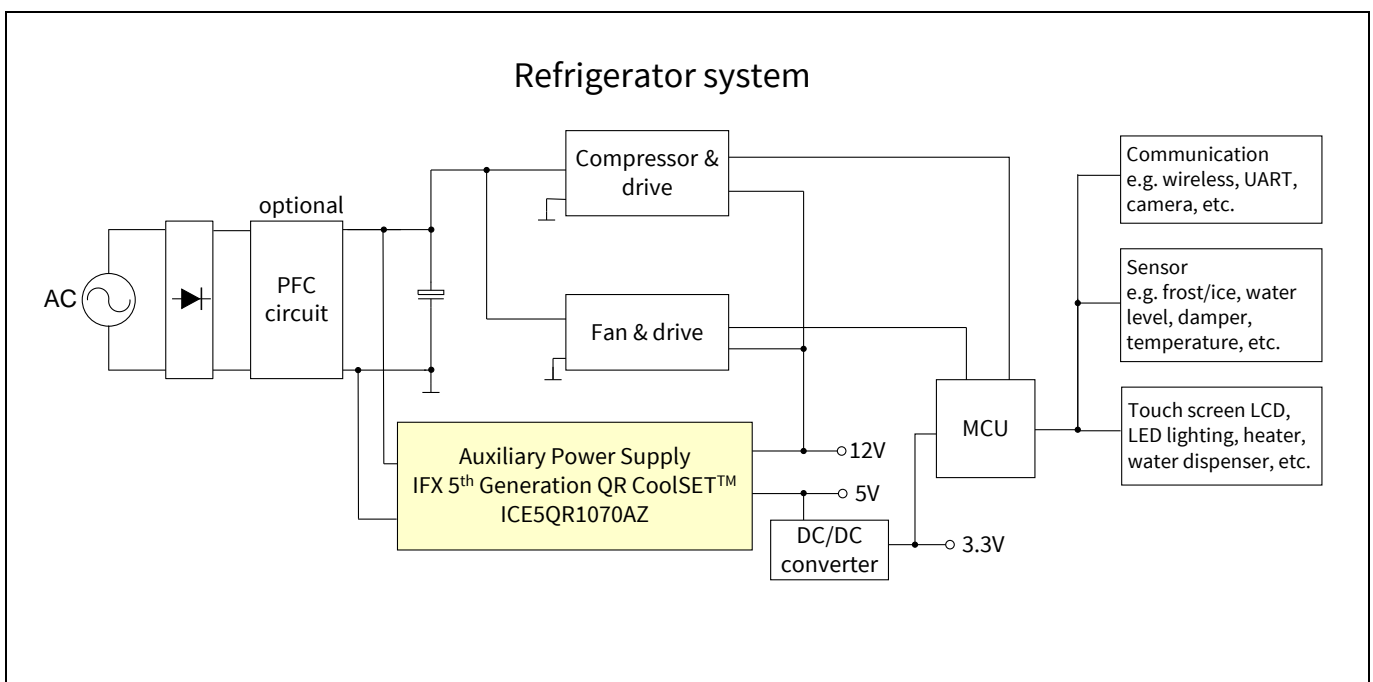

Figure 1 Simplified refrigerator system block diagram

Table 1 lists the system requirements for a refrigerator, and the corresponding Infineon solution is shown in the right-hand column.

Table 1 System requirements and Infineon solutions

	System requirement for a refrigerator	Infineon solution – ICE5QR1070AZ
1	High efficiency under light-load conditions to meet ENERGY STAR requirements	New QR control and active burst mode (ABM)
2	Simplified circuitry with good integration of power and protection features	Embedded 700 V MOSFET and controller in DIP-7 package
3	Single-layer PCB design for compatibility with wave-soldering process and low-cost manufacturing	Input OVP and brown-in/brown-out features
4	Auto-restart protection scheme to minimize interruption to enhance end-user experience	All abnormal protections are in auto restart

System introduction

1.1 High efficiency under light-load conditions to meet ENERGY STAR requirements

During typical refrigerator operation, the power requirement fluctuates according to various use cases. However, in most cases, the refrigerator will reside in an idle state in which the loading towards the auxiliary power supply is low. It is crucial that the auxiliary power supply operates as efficiently as possible, because it will be in this particular state for a prolonged period. Under light-load conditions, losses incurred with the power switch are usually dominated by the switching operation. The choice of switching scheme and frequency play a crucial role in ensuring high conversion efficiency.

In this reference design, ICE5QR1070AZ was primarily chosen due to its QR switching scheme. Compared with a traditional flyback switching scheme, the CoolSET™ will attempt to turn on its integrated HV MOSFET in the valley of the resonant period, thereby minimizing switching losses. Additionally, the fifth-generation QR series has the highest detection rate in the industry, of up to 10 valleys, thereby lowering the switching frequency further along with a reduction in load. Therefore an efficiency of more than 80% is achievable under 25% loading conditions.

1.2 Simplified circuitry with good integration of power and protection features

To relieve the designer of the complexity of PCB layout and circuit design, CoolSET™ is a highly integrated device with both a controller and an high voltage (HV) MOSFET integrated in a single, space-saving DIP-7 package. These certainly help the designer to reduce component count as well as simplifying the layout into a single-layer PCB design for ease of manufacturing, using the traditional, cost-effective wave-soldering process.

1.3 Single-layer PCB design for compatibility with the wave-soldering process and low-cost manufacturing

To counter abnormal line input conditions, CoolSET™ has integrated line input over voltage (OV) as well as brown-in/brown-out protection to increase the robustness of the auxiliary power. In the event of such faults, the controller within the CoolSET™ will halt the switching operation of the integrated HV MOSFET, thereby preventing permanent damage. These features allow the designer to reduce the complexity of introducing additional external circuitry and yield a saving of as many as 15 components.

1.4 Auto-restart protection scheme to minimize interruption to enhance end-user experience

For a refrigerator it would be annoying to both the end-user and the manufacturer if the system were to halt and latch after protection. To minimize interruption, the CoolSET™ implements auto-restart mode for all abnormal protections.

2 Reference design board

This document provides complete design details including specifications, schematics, Bill of Materials (BOM), and PCB layout and transformer design and construction information. This information includes performance results pertaining to line/load regulation, efficiency, transient load, thermal conditions, conducted EMI scans, etc.

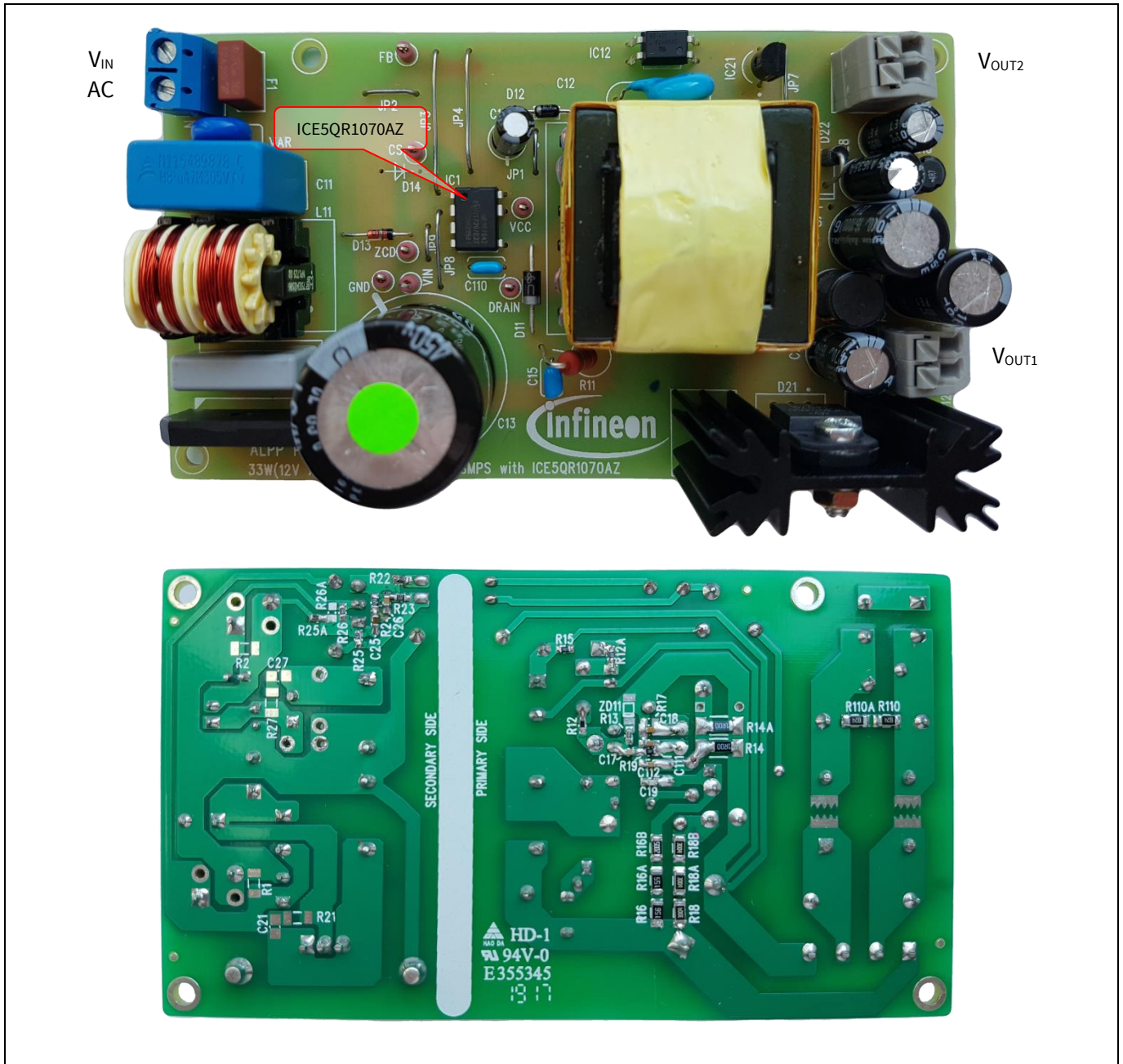

Figure 2 REF_5QR1070AZ_33W1

Power supply specifications

3 Power supply specifications

The table below represents the minimum acceptance performance of the design. Actual performance is listed in the measurements section.

Table 2 Specifications of REF_5QR1070AZ_33W1

Description	Symbol	Min.	Typ.	Max.	Units	Comments
Input						
Voltage	V_{IN}	85	–	300	V AC	2 wires (no P.E.)
Frequency	f_{LINE}	47	50/60	64	Hz	
No-load input power	P_{stby_NL}	–	–	0.08	W	230 V AC
30 mW load input power	P_{stby_ML}	–	–	0.20	W	230 V AC
Output						
Output voltage 1	V_{OUT1}	–	12	–	V	±5%
Output current 1	I_{OUT1}	0	1	2.66	A	
Output voltage ripple 1	$V_{RIPPLE1}$	–	–	100	mV	20 MHz BW
Output voltage 2	V_{OUT2}	–	5	–	V	±5%
Output current 2	I_{OUT2}	0.006	0.06	0.2	A	
Output voltage ripple 2	$V_{RIPPLE2}$	–	–	100	mV	20 MHz BW
Max. power output	P_{OUT_Max}	–	–	33	W	
Efficiency						
Max. load	η	–	84	–	%	115 V AC/230 V AC
Average efficiency at 25%, 50%, 75% and 100% of P_{OUT_Max}	η_{avg}	82	–	–	%	115 V AC/230 V AC
Environmental						
Conducted EMI		6	–	–	dB	Margin, CISPR 22 class B
ESD		10	–	–	kV	EN 61000-4-2
Surge immunity						EN 61000-4-5
Differential Mode (DM)		2	–	–	kV	
Common Mode (CM)		4	–	–	kV	
Ambient temperature	T_{amb}	0	–	50	°C	Free convection, sea level
Form factor		117 × 66 × 30			mm ³	L × W × H

- Minimum load condition (min. load) : 5 V at 6 mA and 12 V 0 A
- Typical load condition (typ. load) : 5 V at 60 mA and 12 V at 1 A
- Maximum load condition (max. load) : 5 V at 200 mA and 12 V at 2.66 A

Circuit diagram

4 Circuit diagram

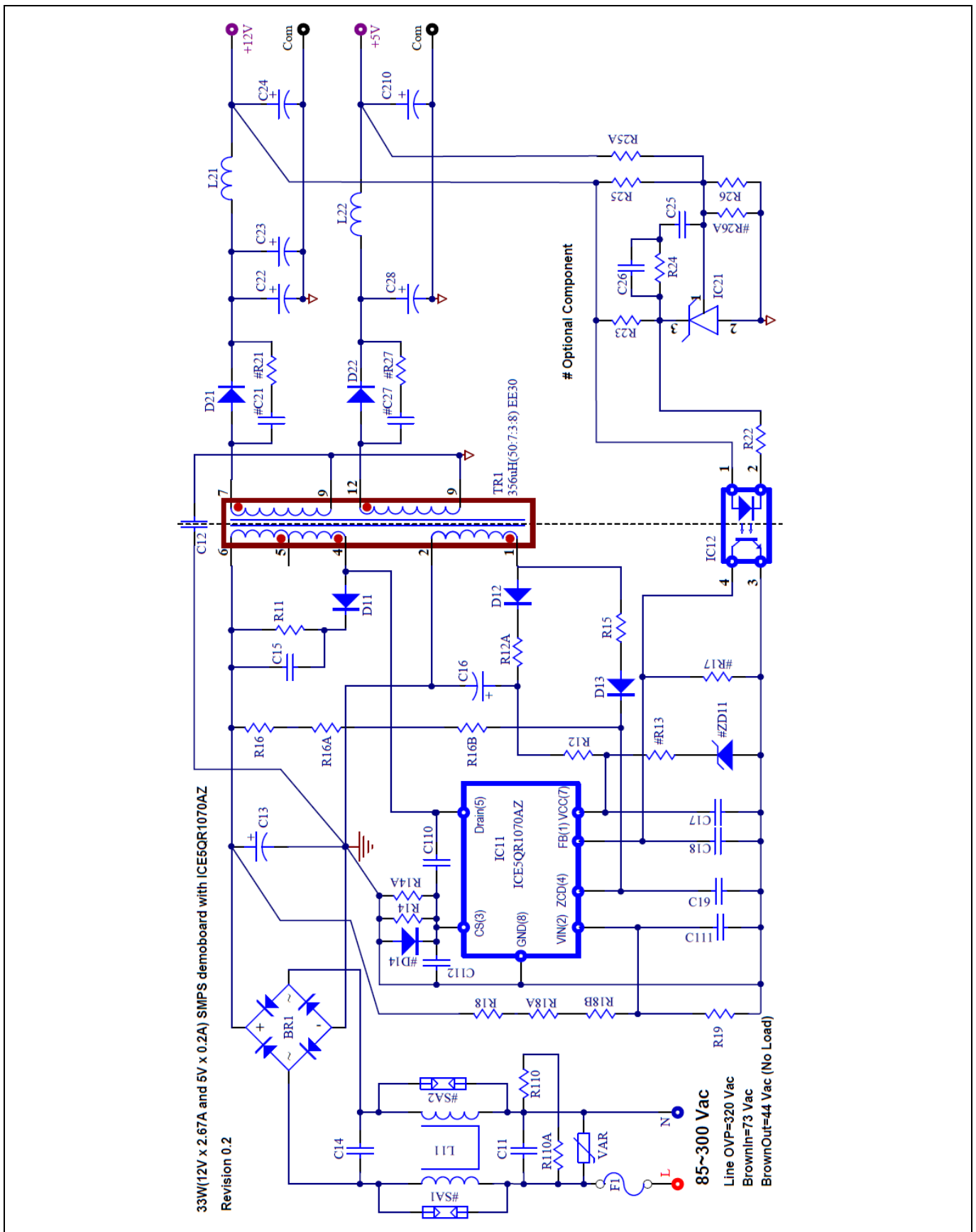

Figure 3 Schematic of REF_5QR1070AZ_33W1

5 Circuit description

In this section, the reference design circuit for refrigerator auxiliary power will be briefly described by the different functional blocks. For details of the design procedure and component selection for the flyback circuitry please refer to the IC design guide [2] and calculation tool [3].

5.1 EMI filtering and line rectification

The input of the refrigerator auxiliary power unit is taken from the AC power grid which is in the range of 85 V AC ~ 300 V AC. The fuse F1 is right at the entrance to protect the system in case of excess current entering the system circuit due to any fault. Following is the varistor VAR, which is connected across L and N to absorb the line surge transient. Inductors L11, C11 and C14 form a π filter to attenuate the DM and CM conducted EMI noise. C11 and C14 must be X-capacitor grade. The values of L11, C11 and C14 are verified and confirmed during the conducted EMI measurement. There are optional spark-gap devices SA1 and SA2 to absorb further higher surge level transient if required by the system. Resistors R10 and R10A are used to discharge the X-capacitor when the AC is off in order to fulfill the IEC61010-1 and UL1950 safety requirement. The bridge rectifier BR1 rectifies the AC input into DC voltage, filtered by the bulk capacitor, C13.

The above is not applicable if the PFC circuit is used as shown in Figure 1.

5.2 Flyback converter power stage

The flyback converter power stage consists of C13, transformer TR1, a primary HV MOSFET (integrated into ICE5QR1070AZ), secondary rectification diodes D21 and D22, secondary output capacitors and filtering (C22, C23, L21 and C24 for V_{OUT1} and C28, L22 and C210 for V_{OUT2}).

When the integrated CoolMOS™ turns on, some energy is stored in the transformer. When it turns off, the stored energy would release to the output capacitors and the output loading through the output diode D21 and D22.

Sandwich winding structure for the transformer TR1 is used to reduce the leakage inductance, and so the loss in the clamper circuit is reduced. TR1 has two output windings; one for the V_{OUT1} (12 V) and the other for the V_{OUT2} (5 V). The output rectification of V_{OUT1} is provided by the diode D21 through filtering of C22, C23, L21 and C24. The output rectification of V_{OUT2} is provided by diode D22 through filtering of C28, L22 and C210. All the secondary capacitors must be the low-ESR type, which can effectively reduce the switching ripple. Together with the Y-capacitor C12 across the primary and secondary side, the EMI noise can be further reduced to comply with CISPR 22 specifications.

5.3 Control of Flyback converter through fifth-generation QR CoolSET™ ICE5QR1070AZ

5.3.1 Integrated HV power MOSFET

The ICE5QR1070AZ CoolSET™ is a seven-pin device in a DIP-7 package. It has been integrated with the new QR PWM controller and all necessary features and protections, and most importantly the 700 V power MOSFET, Infineon Superjunction (SJ) CoolMOS™. Hence, the schematic is much simplified and the circuit design is made much easier.

Circuit description

5.3.2 Current sensing (CS)

The ICE5QR1070AZ is a current mode controller. The peak current is controlled cycle-by-cycle through the CS resistors R14 and R14A in the CS pin (pin 3) and so transformer saturation can be avoided and the system is more robust and reliable.

5.3.3 Feedback (FB) and compensation network

Resistors R25 and R25A are used to sense the V_{OUT1} and V_{OUT2} through the shared current regulation method and FB to the reference pin (pin 1) of error amplifier IC21 with reference to the voltage at resistor R26 and R26A. A type 2 compensation network C25, C26 and R24 is connected between the output pin (pin 3) and the reference pin (pin 2) of the IC21 to stabilize the system. The IC21 further connects to pin 2 of optocoupler, and IC12 with a series resistor R22 to convert the control signal to the primary side through the connection of pin 4 of the IC12 to ICE5QR1070AZ FB pin (pin 1) and complete the control loop. Both the optocoupler IC12 and the error amplifier IC21 are biased by V_{OUT1} ; IC12 is a direct connection while IC21 is through an R23 resistor.

The FB pin of ICE5QR1070AZ is a multi-function pin which is used to select the entry burst power level (there are two levels available) through R17 and also the burst-on/burst-off sense input during ABM.

5.4 Unique features of the fifth-generation QR CoolSET™ ICE5QR1070AZ to support the requirements of refrigerator auxiliary power

5.4.1 Fast self-start-up and sustaining of V_{CC}

The IC start-up uses the cascode structure integrated into the package to charge up the V_{CC} capacitor during the start-up stage [2]. The ZCD pin (pin 4) is a multi-function pin and it serves as the start-up pin with the connection of pull-up resistors R16, R16A and R16B, which has the other end connecting to the bus voltage during the start-up phase. The device is implemented with two steps of charging current: the smaller current 0.2 mA ($V_{VCC_typ} = 0\text{ V} \sim 1.1\text{ V}$) and the larger current 3.2 mA ($V_{VCC_typ} = 1.1\text{ V} \sim 16\text{ V}$). The start-up time consists of the addition of those two charging times. With V_{CC} capacitor C16 at 33 μF , the start-up time is shortened to around 0.3 s.

After start-up, the IC V_{CC} supply is sustained by the auxiliary winding of transformer TR1, which needs to support the V_{CC} to be above under voltage lockout (UVLO) voltage (10 V typ.) through the rectifier circuit D12, R12, R12A and C16.

5.4.2 QR switching with valley sensing

ICE5QR1070AZ is a QR flyback controller which always turns on at the lowest valley point of the drain voltage. The IC senses the valley point through the ZCD pin (pin 4), which monitors auxiliary winding voltage by R15, D13 and C19 to the ZCD pin (pin 4) together with the internal resistor R_{ZCD} . The IC detects the valley crossing signal. When the ZCD voltage drops below 100 mV (typ.), the CoolMOS™ is allowed to switch-on. With QR switching, the lowest switching losses can be achieved for good efficiency.

5.4.3 System robustness and reliability through protection features

5.4.3.1 Input voltage monitoring and protection

To avoid system damage due to the high AC input transient, refrigerator auxiliary power requires the input line OV protection to stop the flyback converter switching whenever the V_{BUS} voltage exceeds the operating range. The IC has a V_{IN} pin (pin 2), which can sense V_{BUS} voltage through voltage dividers R18, R18A, R18B and R19. When the V_{IN} pin exceeds the protection threshold 2.9 V (typ.), the IC stops switching. With the same V_{IN} sensing,

Circuit description

ICE5QR1070AZ also implements input under voltage (UV) protection (brown-in/brown-out) to prevent the over current (OC) stress of the power stage components when the input voltage is too low.

5.4.3.2 Other protections with auto restart

Besides input OV and UV protection, ICE5QR1070AZ has more comprehensive protection features to protect the system, such as V_{CC} OV, V_{CC} UV, over-load, output short-circuit, open-loop protection, output OV, over-temperature, CS short-to-GND, V_{CC} short-to-GND, etc.

5.5 Clamper circuit

A clamper network, D11, C15 and R11, is used to reduce the switching spikes for the drain pin, which are generated from the leakage inductance of the transformer TR1. This is a dissipative circuit and the selection of the R11 needs to be fine-tuned.

5.6 PCB design tips

For a good PCB design layout, there are several points to note.

- The power loop needs to be as small as possible (see Figure 4). There are three power loops in the reference design; one from the primary side and two from the secondary side. For the primary side, it starts from the bulk capacitor (C13) positive to the bulk capacitor negative. The power loop components include C13, the main primary transformer winding (pin 6 and pin 4 of TR1), the drain pin and CS pin of the CoolSET™ IC11 and CS resistors R14 and R14A. For the secondary side, the 12 V output starts from the secondary transformer windings (pin 7 and 9 of TR1), output diode D21 and output capacitors C22 and C23, while the 5 V output starts from the secondary transformer windings (pins 10 and 12 of TR1), output diode D22 and output capacitor C28.
- Star ground concept should be used to avoid unexpected HF noise coupling to affect the proper control. The ground of the small-signal components, e.g. C111, C17, C18, C19 and R19, and emitter of optocoupler (pin 3 of IC12) etc. should connect directly to the IC ground (pin 8 of IC11). Then it connects to the negative terminal of the C13 capacitor directly.

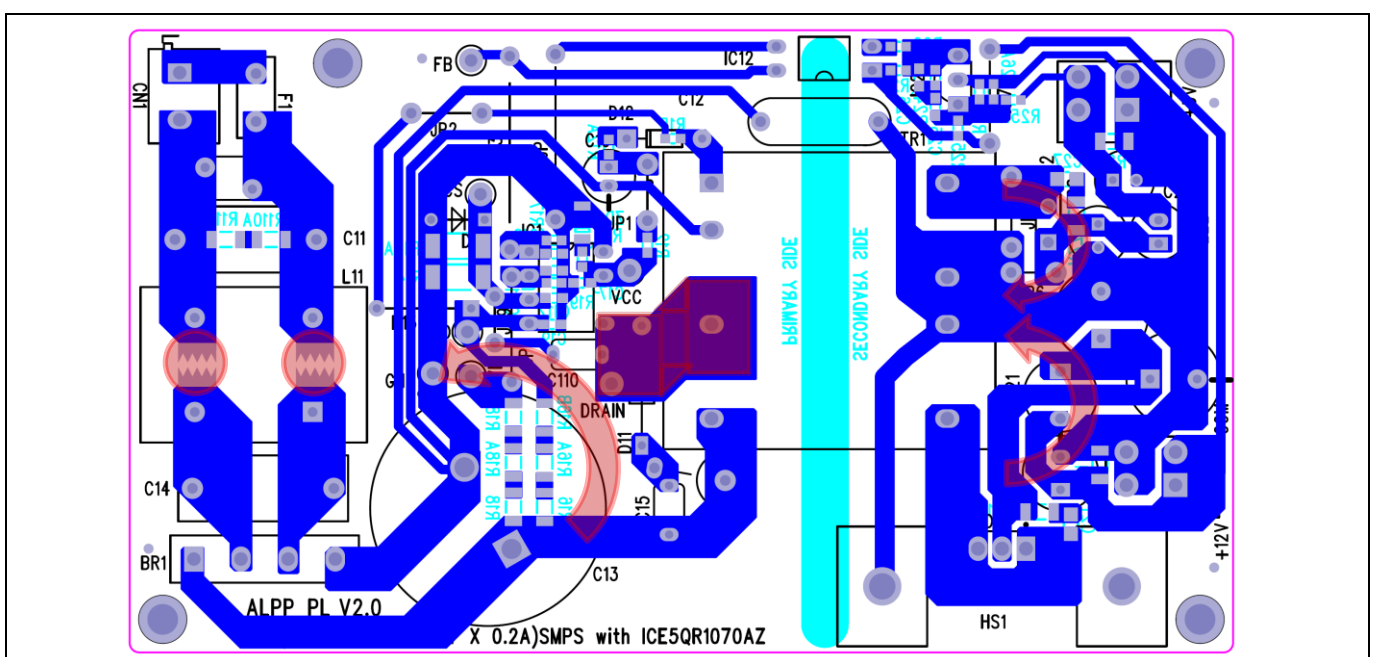

Figure 4 PCB layout tips

Circuit description

- Adding a certain amount of drain PCB copper area or changing to a 2 oz. copper PCB can increase the power capability margin of the CoolSET™.
- Adding the spark-gap (PCB saw-tooth, 0.5 mm separation) pattern under the input CM choke L11 can increase the system input line surge capability.
- Separating the HV components and LV components e.g. clamper circuit (D11, R11 and C15) at the lower part of the PCB (refer to Figure 4) and the other LV components at the top part of the PCB can reduce the spark-over chance of the high energy surge during ESD or a lightning surge test.

5.7 EMI reduction tips

EMI compliance is always a challenge for the power supply designer. There are several critical points to consider in order to achieve satisfactory EMI performance.

- Good transformer winding coupling is very important. Without this it would lead to high leakage inductance and incur a lot of switching spike and HF noise. The most effective method is to adopt sandwich winding (refer to Figure 8) where the secondary winding is in the middle of the winding and covered by the primary winding on the bottom and top layer. Shielding the transformer can reduce the HF noise. The outermost shield wrapped around the transformer cores with copper foil can help to reduce leakage flux and reduce the noise coupling to nearby components. The inner shield (copper foil or copper wire winding) between the transformer windings can help to reduce the parasitic capacitance and reduce the HF noise coupling. Both shields need to tie to the negative of C13 to achieve the best performance, but note that the inner shield approach would result in more energy loss.
- Short power loop design in PCB (as described in section 5.6) and terminate to the low ESR capacitor such as C13 for primary side loop and C22, C23 and C28 for the secondary side loops. It can help to reduce the switching ripple which comes out to the input terminals V_{IN} . In addition, adding a low ESR ceramic capacitor in parallel to the C13/C22/C23/C28 can help to further reduce the switching ripple.
- Sufficient input LC (L11, C14 and C11) filter design is important to pass the EMI requirement. As a note that the most effective capacitor is C11 which has the best filtering capability to the switching ripple.
- The Y-capacitor C12 has a function to return the HF noise to the source (negative of C13) and reduce the overall HF noise going out to the input terminals. The larger capacitance is more effective. However, larger value would introduce larger leakage current and may fail the safety requirement.

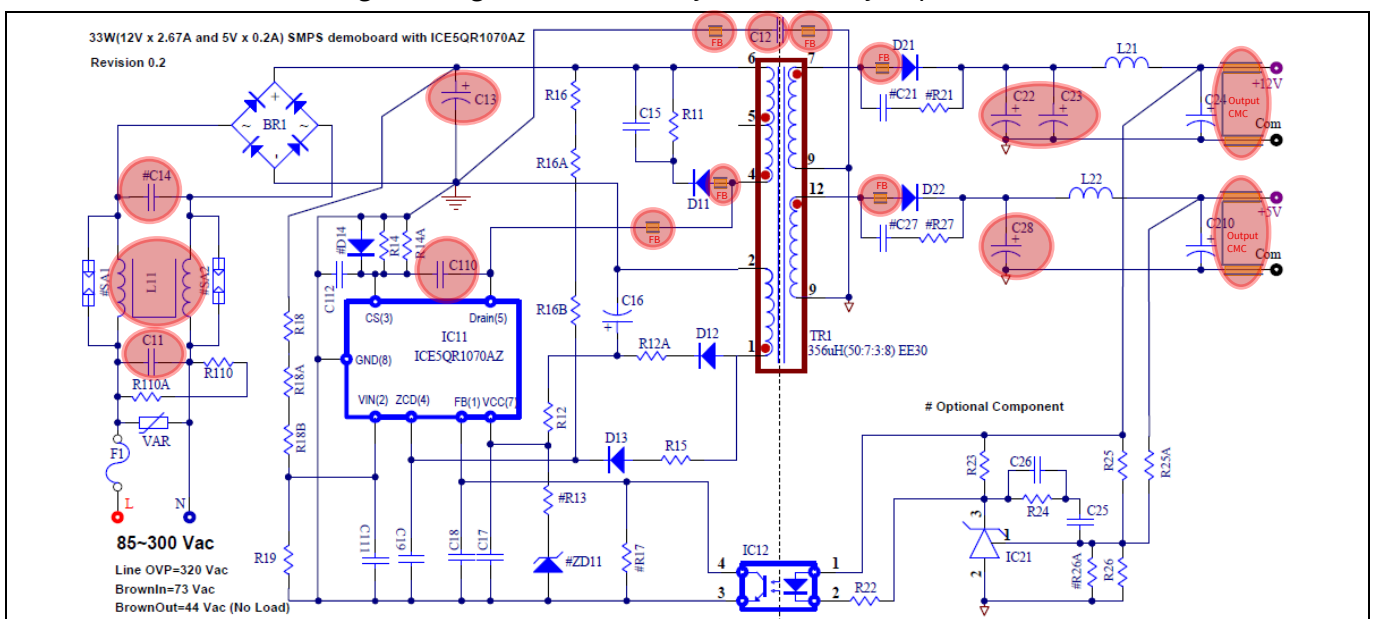

Figure 5 EMI reduction tips

Circuit description

- Adding drain to CS capacitor C110 for the MOSFET of the CoolSET™ can reduce the high switching noise. However, it also reduces efficiency.
- Adding a ferrite bead to the critical nodes of the circuit can help to reduce the HF noise, such as the connecting path between the transformer and the drain pin, clamper diode D11, output diodes (D21 and D22), Y-capacitor C12, etc.
- Adding additional output CM Choke (CMC) can also help to reduce the HF noise.

BOM

7 BOM

Table 3 BOM (R0.4)

Item	Circuit code	Description	Part number	Manufacturer	Qty.
1	BR1	600 V/2 A, bridge diode	D2SB60A	Shindengen	1
2	C11	0.47 μ F/305 V	B32922C3474M000	Epcos	1
3	C12	2.2 nF/500 V KL, Y1-cap	DE1E3RA222MA4BQ	Murata	1
4	C13	82 μ F/450 V, E-cap	LLS2W820MELZ		1
5	C14	0.1 μ F/305 V	B32922C3104M000	Epcos	1
6	C15	2.2 nF/1000 V, clamper cap	RDE7U3A222J3K1H03	Murata	1
7	C16	33 μ F/50 V, E-cap	50PX33MEFC5X11	Rubycon	1
8	C17	100 nF/50 V	GRM188R71H104KA93D	Murata	1
9	C18, C26	1 nF/50 V	GRM1885C1H102GA01D	Murata	2
10	C19	68 pF/50 V	GRM1885C1H680GA01D	Murata	1
11	C110	22 pF/1000 V	RDE7U3A220J2K1H03	Murata	1
12	C111, C112	22 nF/50 V	GCM188R71H223KA37D	Murata	2
13	C22, C23	1000 μ F/16 V, E-cap, low ESR 28 m Ω , 10 \times 16	16ZLH1000MEFC10X16	Rubycon	2
14	C24	470 μ F/16 V, E-cap, low ESR 56 m Ω , 8 \times 11.5	16ZLH470MEFC8X11.5	Rubycon	1
15	C25	220 nF/50 V	GRM188R71H224KAC4D	Murata	1
16	C28, C210	330 μ F/10 V, E-cap, low ESR 94 m Ω , 6.3 \times 11	10ZLH330MEFC6.3X11	Rubycon	2
17	D11	1 A/800 V, ultra-fast diode	UF4006		1
18	D12	0.2 A/200 V, diode	1N485B		1
19	D13	0.2 A/150 V/50 ns, diode	FDH400		1
20	D21	30 A/100 V, Schottky diode, TO220 Full Pak	VF30100SG		1
21	D22	1 A/50 V, Schottky diode	SB150		1
22	F1	2 A/300 V, time-delay fuse	36912000000		1
23	HS21	Heatsink for D21	513002B02500G		1
24	IC11	1.25 Ω , 700 V Gen5 QR CoolSET™, DIP-7	ICE5QR1070AZ	Infineon	1
25	IC12	Optocoupler, CTR 100 ~ 200% DIP-4	SFH617A-3		1
26	IC21	2.5 V shunt regulator, TO92	TL431BVLPG		1
27	JP1, JP2, JP3, JP4, JP8 and JP9	Φ 0.8 mm jumper			6
28	L11	39 mH/1 A, input CMC	750343586	Würth Electronics	1
29	L21	2.2 μ H/6 A, D-choke	744772022	Würth Electronics	1
30	L22	4.7 μ H/4.2 A, D-choke	744 746 204 7	Würth Electronics	1
31	R11	15 k Ω /700 V	ERG-2SJ153A		1
32	R12	27 Ω (0603)			1
33	R12A	0 Ω (0603)			1
34	R14, R14A	1R/1 W/ \pm 1% (1206)			2
35	R15	24 k Ω / \pm 1% (0603)			1
36	R16, R16A	15 MR (1206)	RC1206JR-0715ML		2
37	R16B	20 MR (1206)			1

33 W auxiliary SMPS for refrigerator using ICE5QR1070AZ

REF_5QR1070AZ_33W1



BOM

38	R18, R18A, R18B	3 MR (1206)	RC1206FR-073ML		3
39	R19	59 kR/0.5% (0603)	ERJ-3RBD5902V		1
40	R110, R110A	845 k Ω /200 V (1206)			2
41	R22	820 Ω (0603)			1
42	R23	1.2 k Ω (0603)			1
43	R24	12 k Ω (0603)			1
44	R25	16 k Ω (0603)			1
45	R25A	6.2 k Ω (0603)			1
46	R26	2.49 k Ω (0603)			1
47	TR1	Lp = 356 μ H, EE30/15/7, horizontal bobbin	750343534	Würth Electronics	1
48	Test point of FB, V _{IN} , CS, ZCD, drain, V _{CC} , GND	Test point	5010		7
49	VAR	0.25 W/320 V, SiOV metal oxide varistor	B72207S2321K101	Epcos	1
50	Con (L N)	Connector	691102710002	Würth Electronics	1
51	Con (+12 V com), con (+5 V com)	Connector	691 412 120 002B	Würth Electronics	2

Transformer specification

8 Transformer specification

(Refer to Appendix A for transformer design and Appendix B for WE transformer specification.)

- Core and materials: EE30/15/7 (EF30), TP4A (TDG)
- Bobbin: 070-5313 (12-pin, THT, horizontal version)
- Primary inductance: $L_p = 356 \mu\text{H}$ ($\pm 10\%$), measured between pin 4 and pin 6
- Manufacturer and part number: Würth Electronics Midcom (750343534)

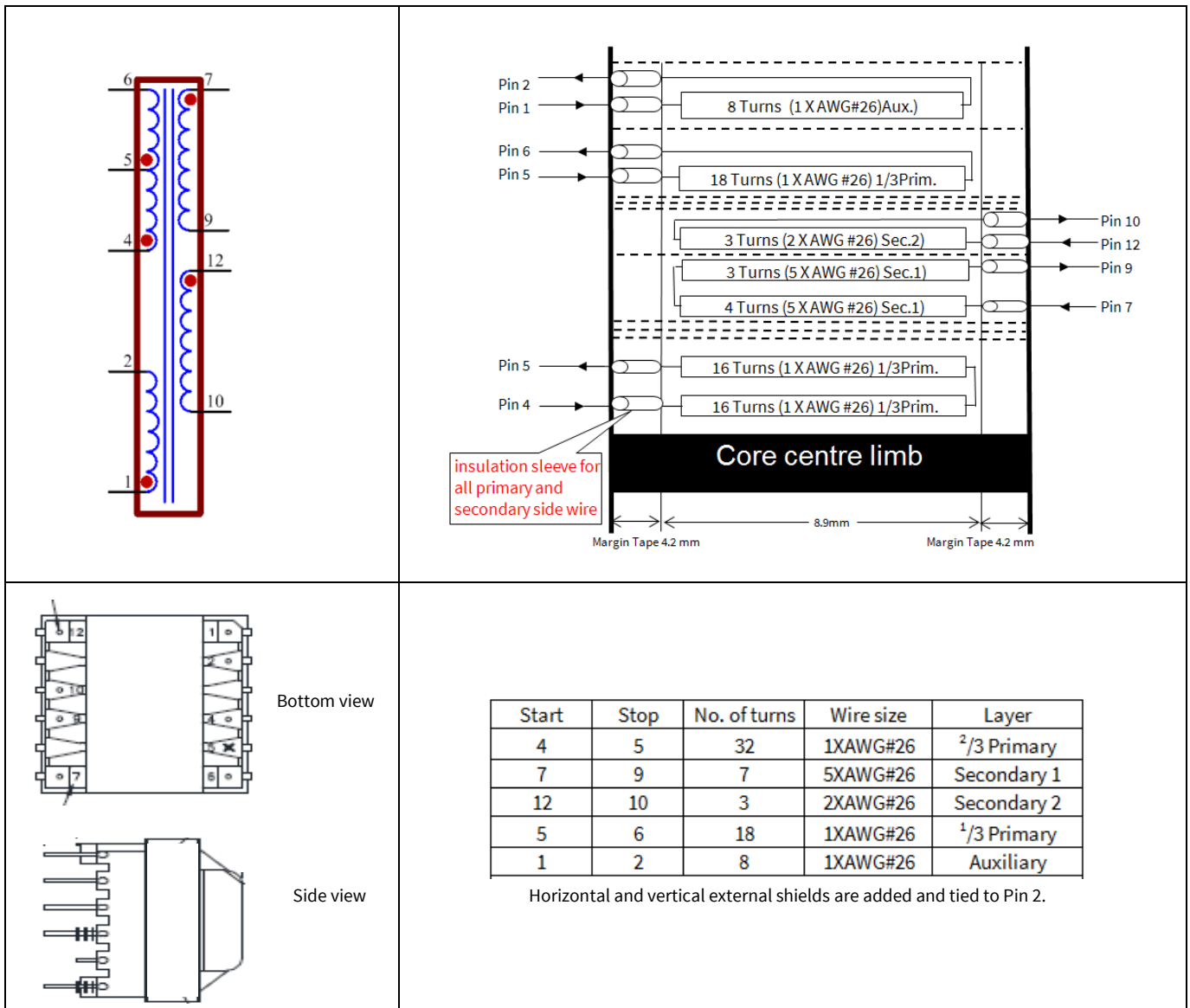

Figure 8 Transformer specifications

9 Measurement data and graphs

Table 4 Measurement data

Input (V AC/Hz)	Description	P _{in} (W)	V _{OUT2} (V DC)	I _{OUT2} (A)	V _{OUT1} (V DC)	I _{OUT1} (A)	P _{out} (W)	η (%)	η _{avg} (%)	P _{in_OLP} (W)	I _{out_OLP} (A) (fixed 5 V at 0.2 A)
85/60	No load	0.05	4.94	0.000	12.10	0.000				51.10	3.35
	Min. load	0.08	4.66	0.006	12.81	0.000	0.03	33.59			
	1/20 load	2.05	4.99	0.010	11.94	0.133	1.64	79.90			
	1/10 load	4.11	4.99	0.020	11.95	0.266	3.28	79.77			
	Typ. load	14.94	5.02	0.060	11.91	1.000	12.21	81.70			
	1/4 load	10.06	5.00	0.050	11.95	0.668	8.22	81.76	82.21		
	1/2 load	19.81	5.00	0.100	11.95	1.335	16.45	83.02			
	3/4 load	29.90	5.00	0.150	11.94	2.002	24.65	82.44			
	Max. load	40.12	5.00	0.200	11.94	2.660	32.75	81.62			
115/60	No load	0.05	4.94	0.000	12.10	0.000				57.50	3.93
	Min. load	0.09	4.66	0.006	12.83	0.000	0.03	31.93			
	1/20 load	2.04	4.99	0.010	11.95	0.133	1.64	80.36			
	1/10 load	4.08	4.99	0.020	11.96	0.266	3.28	80.42			
	Typ. load	14.75	5.01	0.060	11.92	1.000	12.22	82.82			
	1/4 load	9.97	5.00	0.050	11.95	0.668	8.23	82.52	83.87		
	1/2 load	19.52	5.00	0.100	11.95	1.335	16.46	84.30			
	3/4 load	29.25	5.00	0.150	11.94	2.002	24.66	84.30			
	Max. load	38.85	5.00	0.200	11.94	2.660	32.77	84.34			
230/50	No load	0.09	4.94	0.000	12.11	0.000				62.20	4.42
	Min. load	0.13	4.64	0.006	12.87	0.000	0.03	21.42			
	1/20 load	2.11	4.99	0.010	11.96	0.133	1.64	77.75			
	1/10 load	4.17	4.98	0.020	11.97	0.266	3.28	78.74			
	Typ. load	14.74	5.01	0.060	11.93	1.000	12.23	82.95			
	1/4 load	10.07	4.99	0.050	11.96	0.668	8.23	81.77	84.62		
	1/2 load	19.44	4.99	0.100	11.97	1.335	16.47	84.74			
	3/4 load	28.78	4.99	0.150	11.96	2.002	24.70	85.81			
	Max. load	38.06	5.00	0.200	11.96	2.660	32.80	86.18			
265/50	No load	0.10	4.94	0.000	12.11	0.000				64.10	4.58
	Min. load	0.14	4.62	0.006	12.89	0.000	0.03	19.78			
	1/20 load	2.15	4.99	0.010	11.96	0.133	1.64	76.31			
	1/10 load	4.21	4.98	0.020	11.97	0.266	3.28	78.00			
	Typ. load	14.80	5.01	0.060	11.93	1.000	12.23	82.62			
	1/4 load	10.15	4.99	0.050	11.97	0.668	8.24	81.15	84.39		
	1/2 load	19.49	4.99	0.100	11.97	1.335	16.47	84.52			
	3/4 load	28.82	5.00	0.150	11.96	2.002	24.70	85.69			
	Max. load	38.06	5.00	0.200	11.96	2.660	32.81	86.21			
300/50	No load	0.14	4.93	0.000	12.12	0.000				65.85	4.71
	Min. load	0.17	4.62	0.006	12.90	0.000	0.03	16.31			
	1/20 load	2.21	4.98	0.010	11.97	0.133	1.64	74.29			
	1/10 load	4.26	4.98	0.020	11.97	0.266	3.28	77.08			
	Typ. load	14.91	5.01	0.060	11.93	1.000	12.23	82.01			
	1/4 load	10.24	4.99	0.050	11.97	0.668	8.24	80.43	83.93		
	1/2 load	19.59	4.99	0.100	11.97	1.335	16.47	84.09			
	3/4 load	28.97	4.99	0.150	11.96	2.002	24.70	85.25			
	Max. load	38.18	5.00	0.200	11.96	2.660	32.81	85.94			

Measurement data and graphs

- No-load condition (no load) : 5 V at 0 A and 12 V at 0 A
- Minimum load condition (min. load) : 5 V at 6 mA and 12 V 0 A
- 1/20 load condition (1/20 load) : 5 V at 10 mA and 12 V at 133 mA
- 1/10 load condition (1/10 load) : 5 V at 20 mA and 12 V at 266 mA
- Typical load condition (typ. load) : 5 V at 60 mA and 12 V at 1 A
- 1/4 load condition (1/4 load) : 5 V at 50 mA and 12 V at 0.668 A
- 1/2 load condition (1/2 load) : 5 V at 100 mA and 12 V at 1.355 A
- 3/4 load condition (3/4 load) : 5 V at 150 mA and 12 V at 2.002 A
- Maximum load condition (max. load) : 5 V at 200 mA and 12 V at 2.66 A

9.1 Load regulation

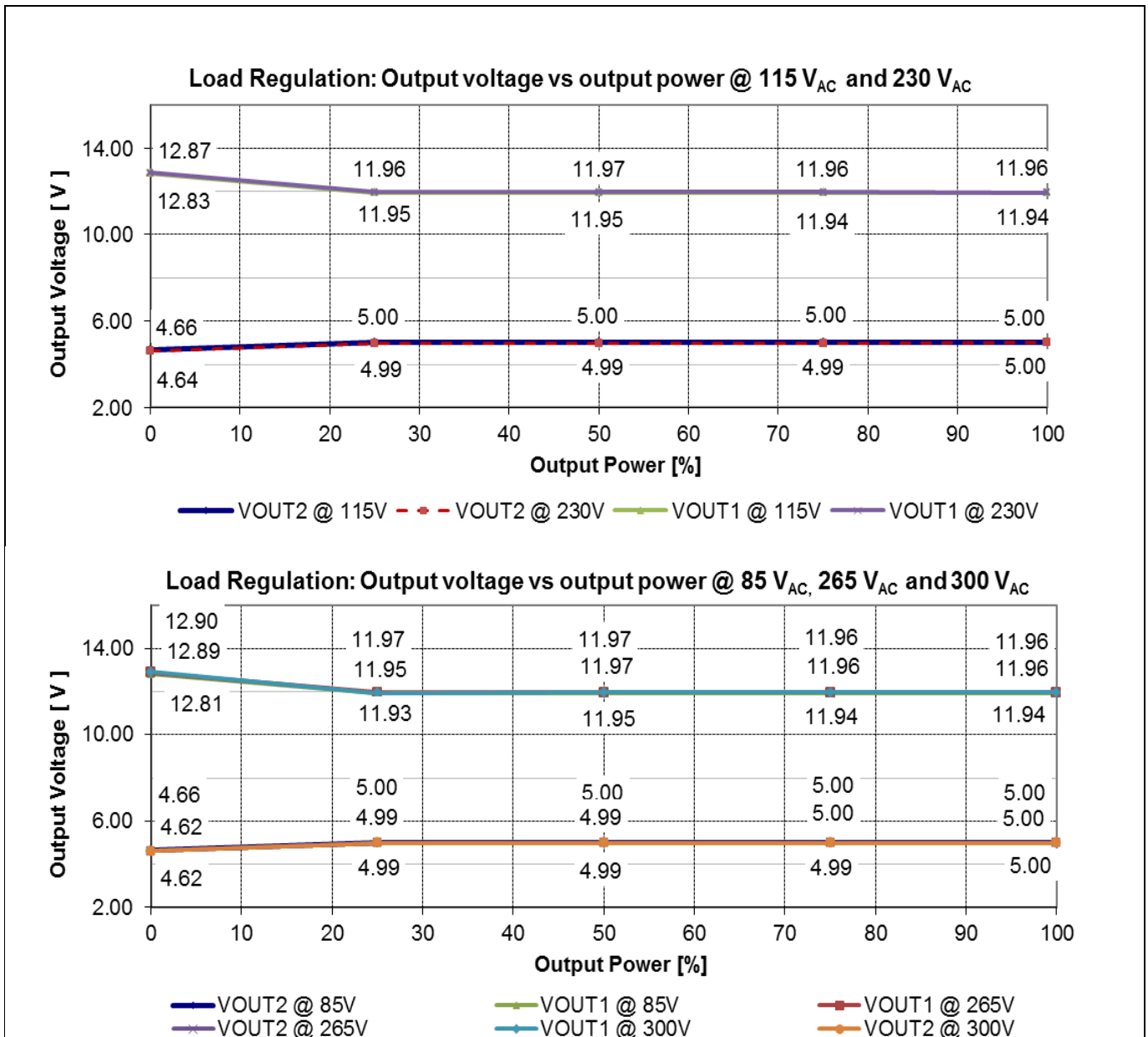

Figure 9 Load regulation V_{OUT} vs output power

9.2 Line regulation

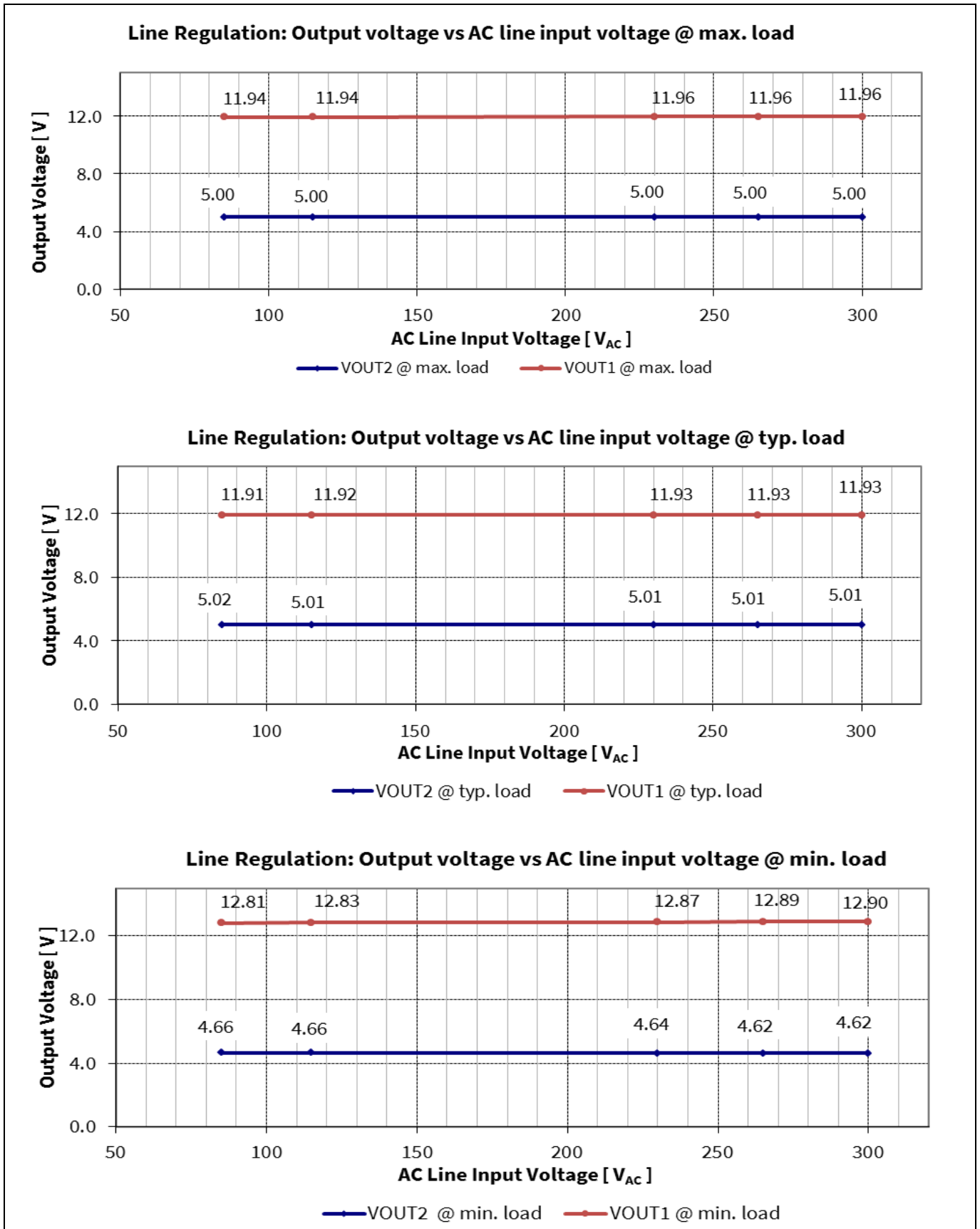

Figure 10 Line regulation: V_{OUT} vs AC-line input voltage

9.3 Efficiency vs AC-line input voltage

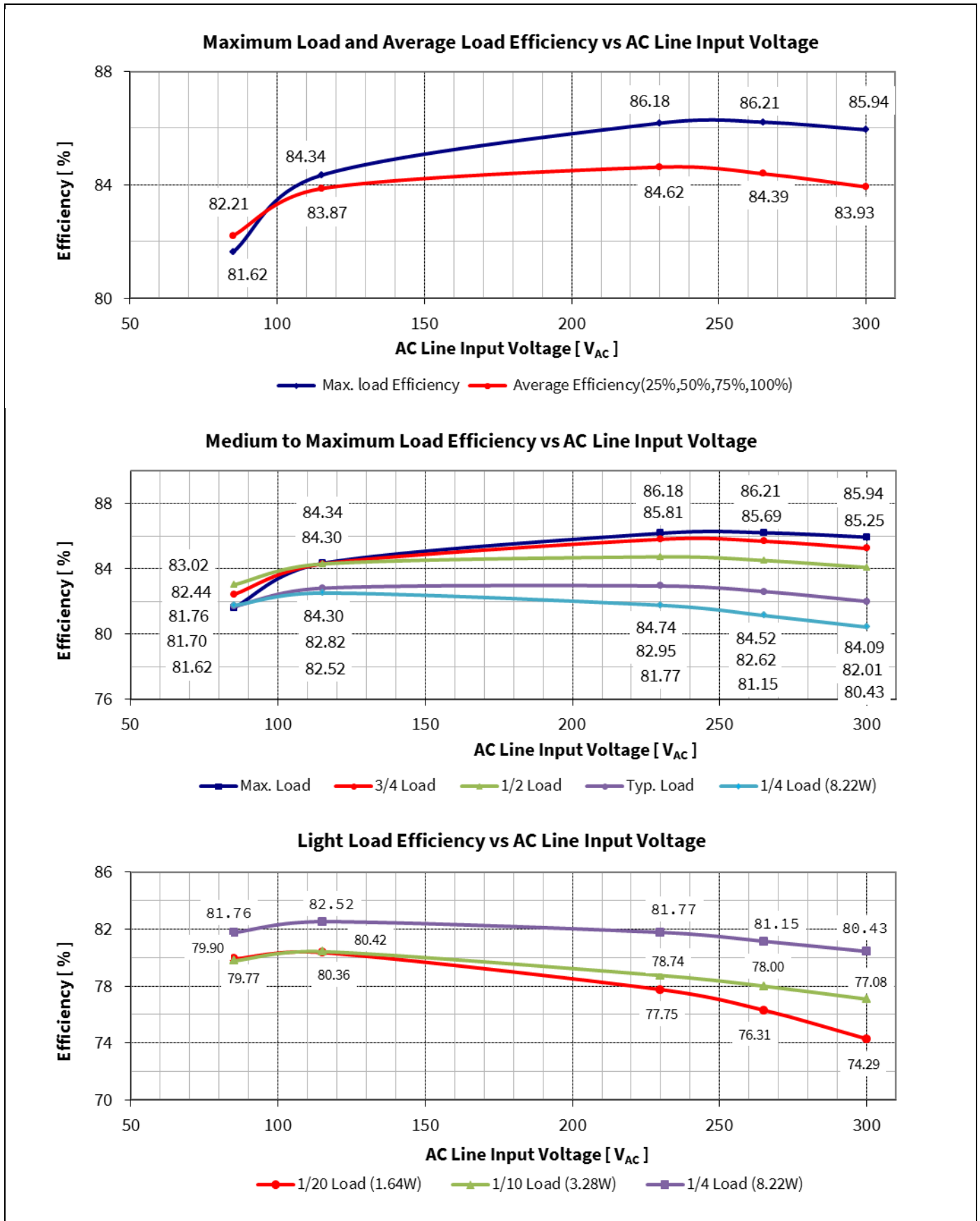

Figure 11 Efficiency vs AC-line input voltage

9.4 Standby power

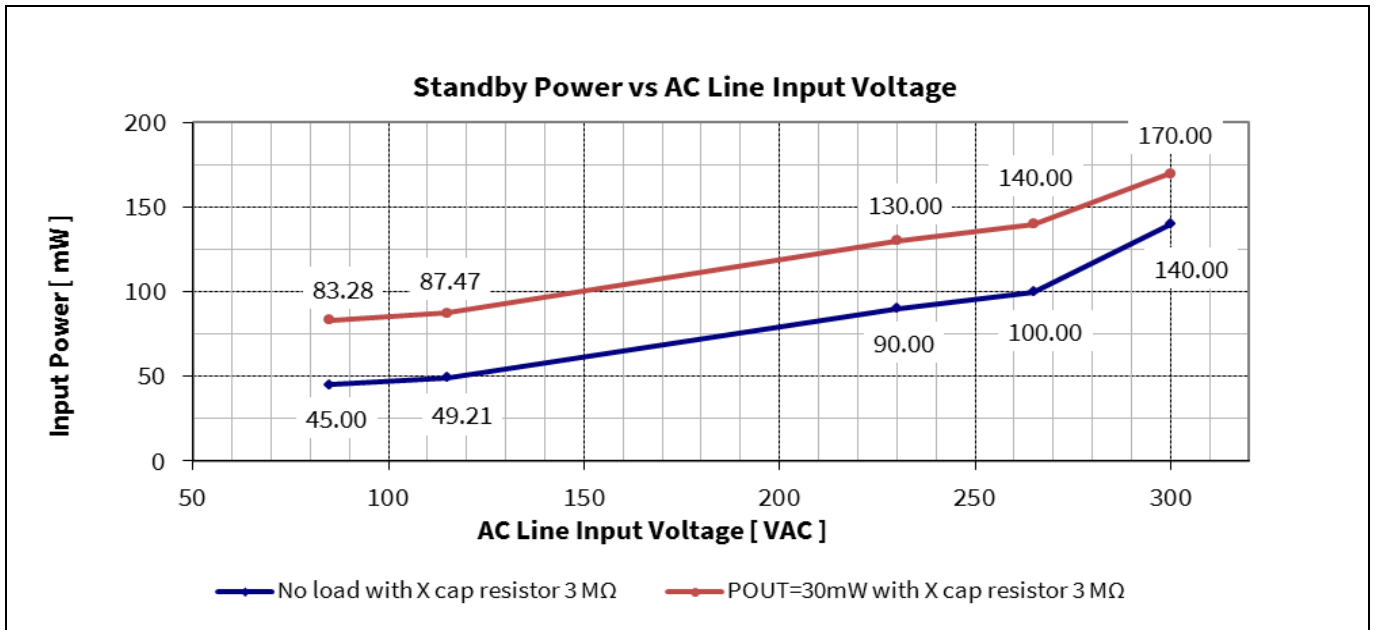

Figure 12 Standby power at no load (P_{stby_NL}) and 30 mW load (P_{stby_ML}) vs AC-line input voltage (measured by Yokogawa WT210 power meter – integration mode)

9.5 Maximum input power

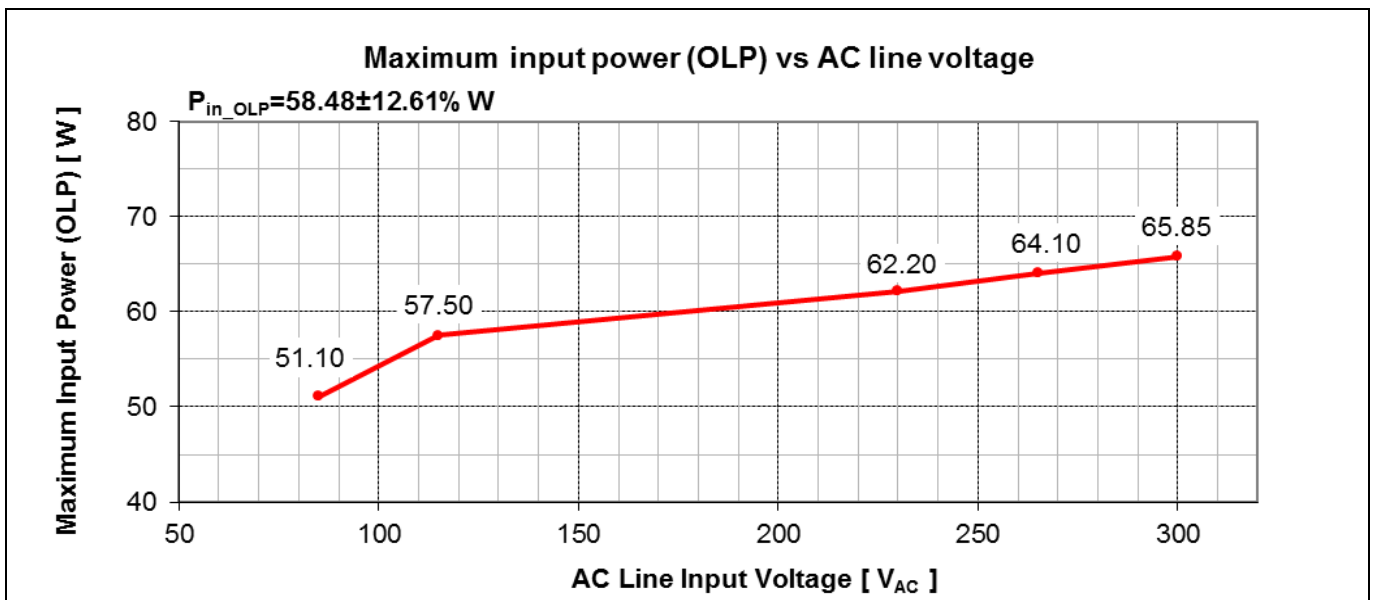

Figure 13 Maximum input power (before over-load protection) vs AC-line input voltage

Thermal performance

10 Thermal performance

The thermal testing of the reference board was done in the open air without forced ventilation at an ambient temperature of 25°C. An infrared thermography camera (FLIR-T62101) was used to capture the thermal reading of particular components. The measurements were taken at the maximum load running for one hour. The tested input voltage was 85 V AC and 300 V AC.

Table 5 Component temperature at full load (12 V 2.66 A and 5 V 0.2 A) under $T_{amb} = 25^{\circ}\text{C}$

Circuit code	Major component	85 V AC ($^{\circ}\text{C}$)	300 V AC ($^{\circ}\text{C}$)
BR1	Bridge diode	57.2	38.0
D21	+ 12 V output diode	61	60.7
D22	+ 5 V output diode	48.2	48.3
IC11	ICE5QR1070AZ	83.2	74.3
L11	Input CMC choke	80.6	38.5
R11	Clamper resistor	85.4	87.1
R14	CS resistor	63.0	53.8
TR1	Main transformer	58.9	62.7
	Ambient	25.0	25.0

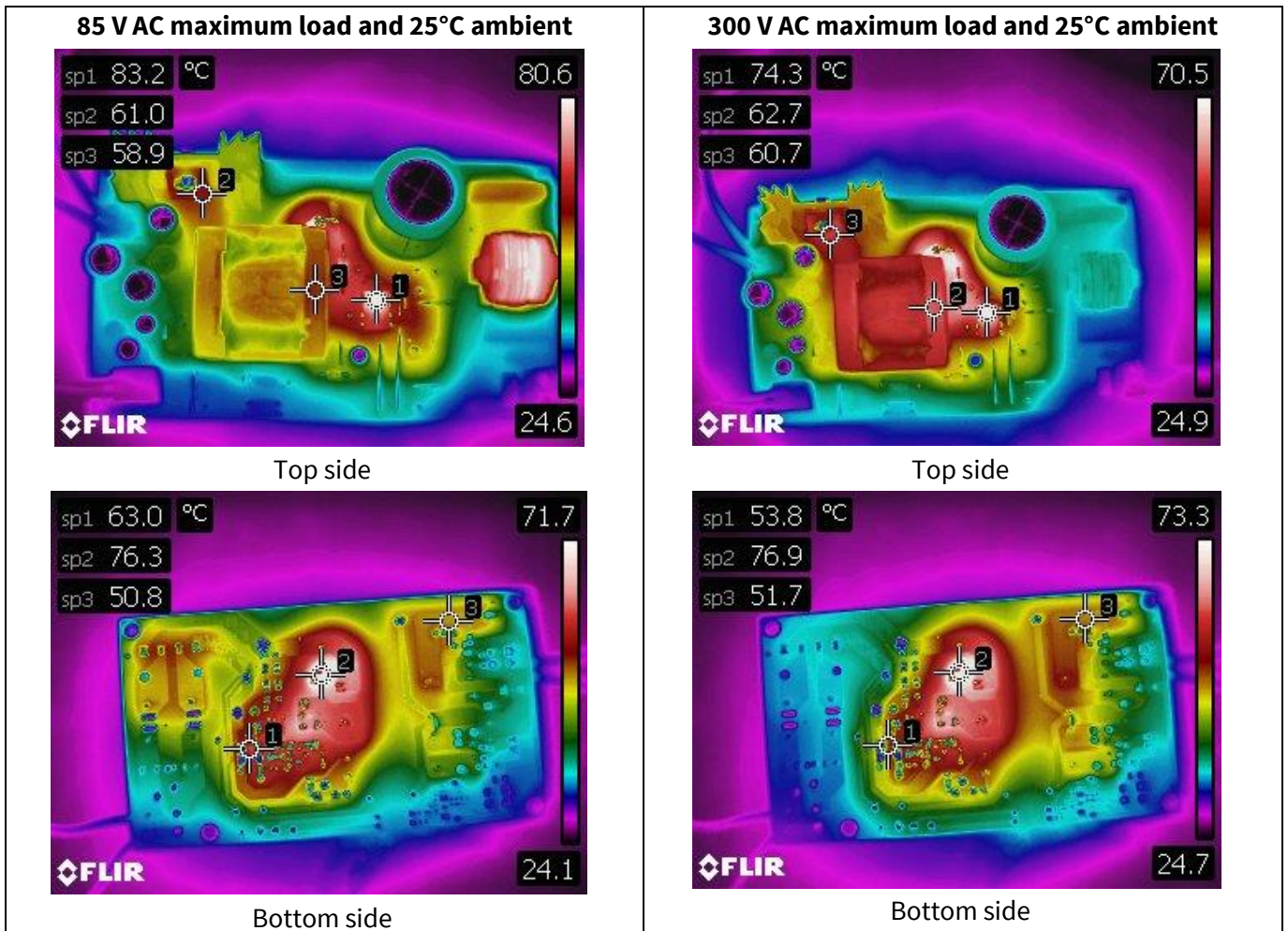

Figure 14 Infrared thermal image of REF_5QR1070AZ_33W1

Waveforms

11 Waveforms

All waveforms and scope plots were recorded with a Teledyne LeCroy 606Zi oscilloscope.

11.1 Start-up at low/high AC-line input voltage with maximum load

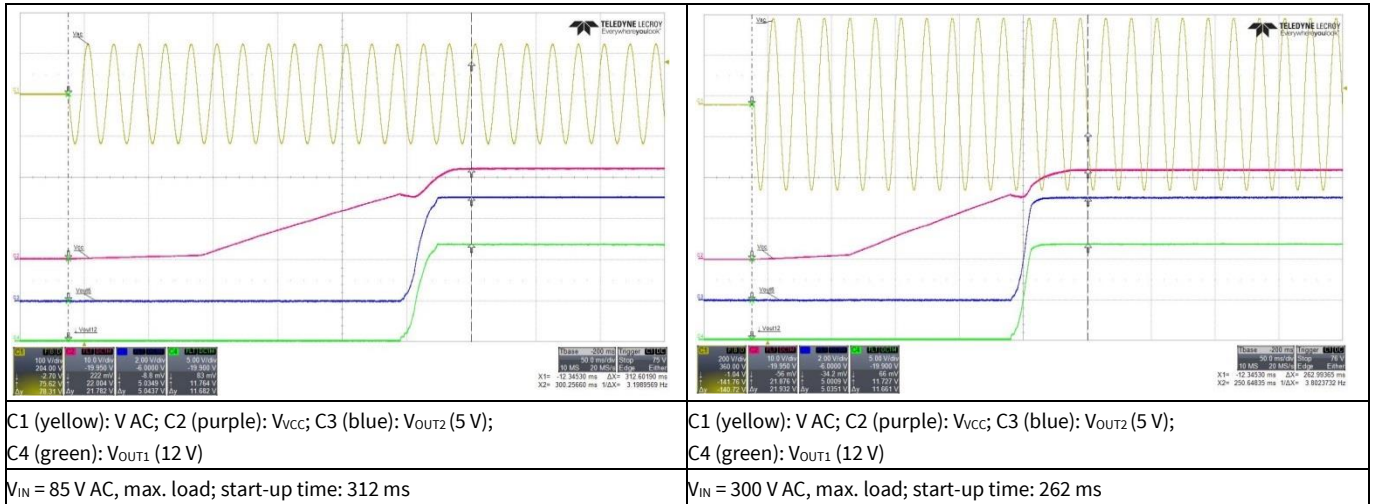

Figure 15 Start-up

11.2 Switching waveform at maximum load

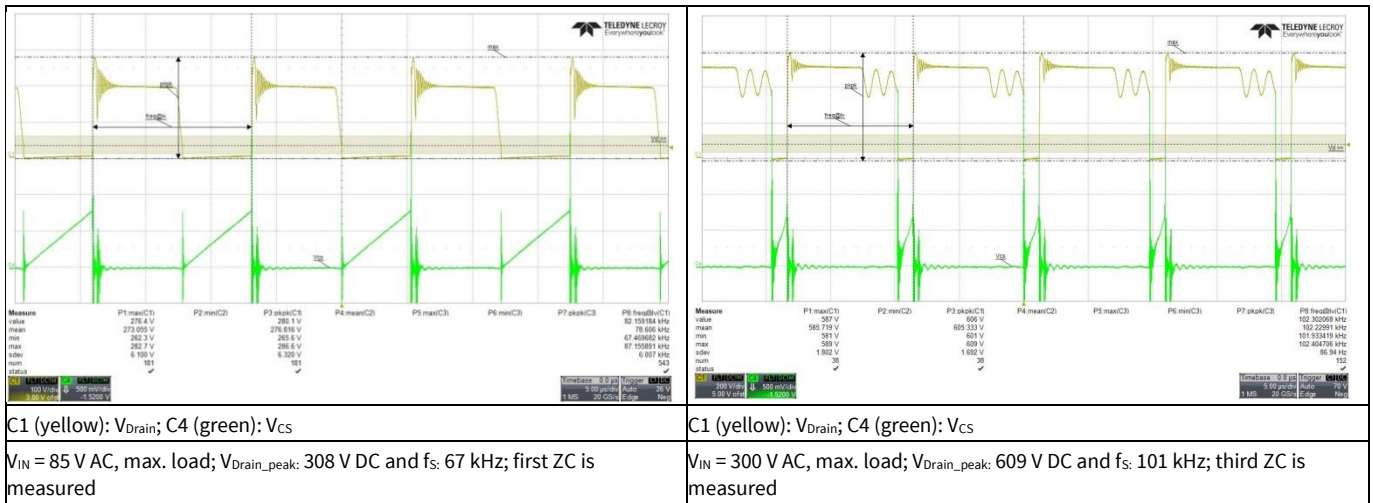

Figure 16 Drain and CS voltage at maximum load

33 W auxiliary SMPS for refrigerator using ICE5QR1070AZ

REF_5QR1070AZ_33W1

Waveforms

11.3 Switching waveform at 25% load

- 25% load (5 V 0.05 A, 12 V 0.667 A)

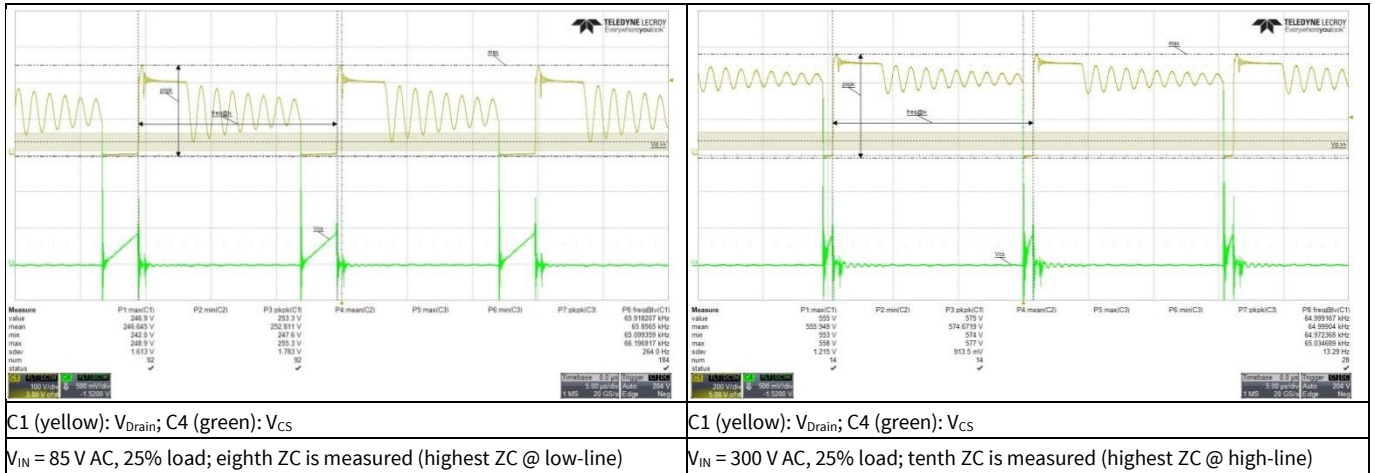

Figure 17 Drain and CS voltage at 25% load

11.4 Output ripple voltage at maximum load

Probe terminal end with decoupling capacitor of 0.1 μF (ceramic) and 1 μF (electrolytic), 20 MHz BW

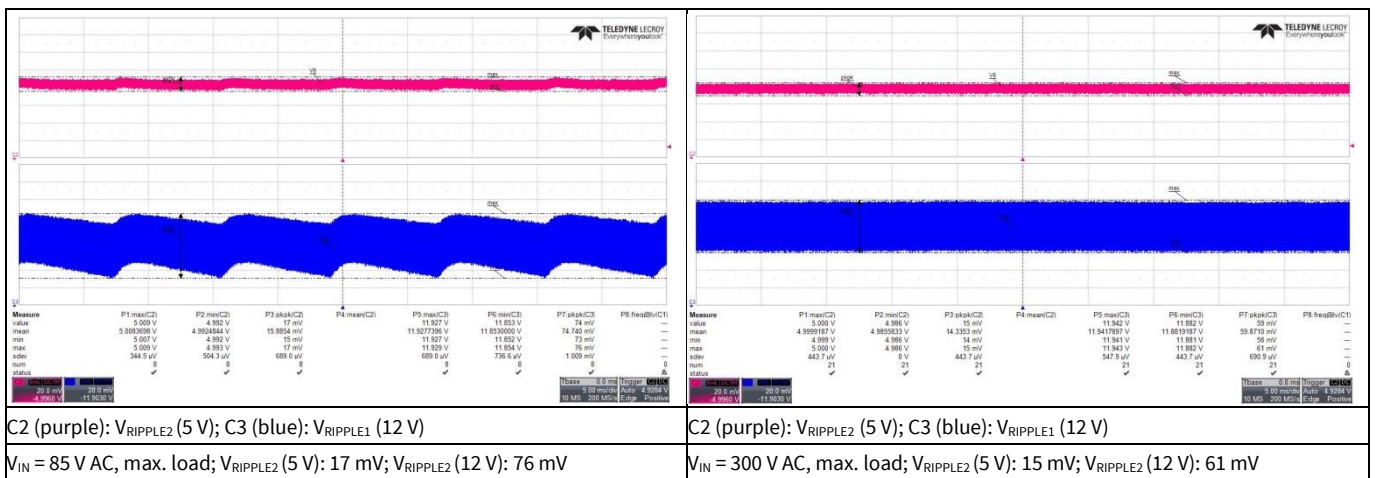

Figure 18 Output ripple voltage at maximum load

Waveforms

11.5 Output ripple voltage in ABM 1 W load

- Probe terminal end with decoupling capacitor of 0.1 μF (ceramic) and 1 μF (electrolytic), 20 MHz BW
- Load: 1 W (5 V at 6 mA and 12 V at 80mA)

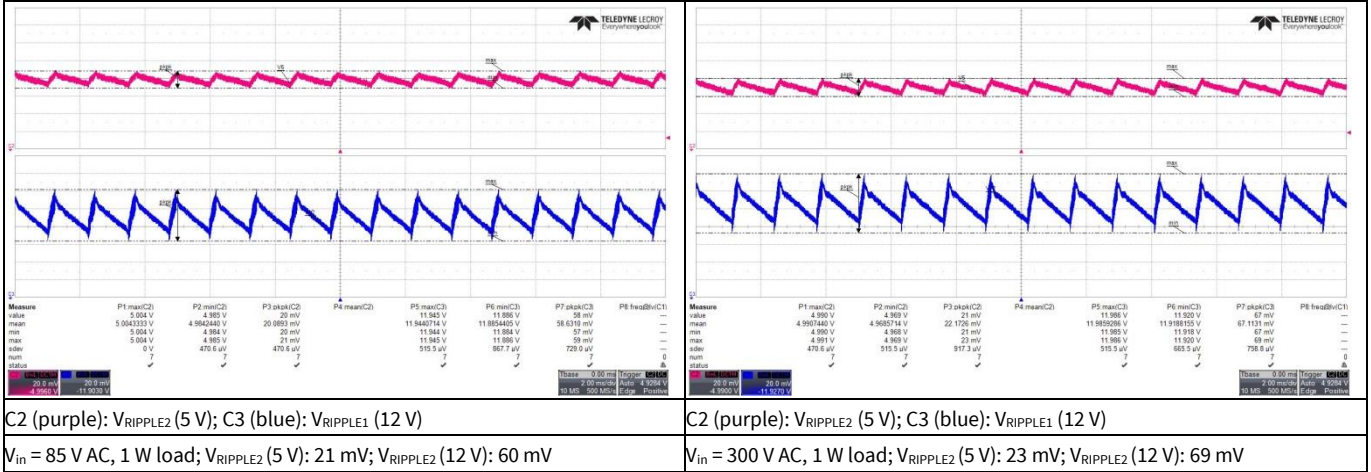

Figure 19 Output ripple voltage in ABM 1 W load

11.6 Load transient response (dynamic load from 10% to 100%)

- Probe terminal end with decoupling capacitor of 0.1 μF (ceramic) and 1 μF (electrolytic), 20 MHz BW
- V load change from 10% to 100% and 5 V at 200 mA load, 100 Hz, 0.4 A/ μs slew rate

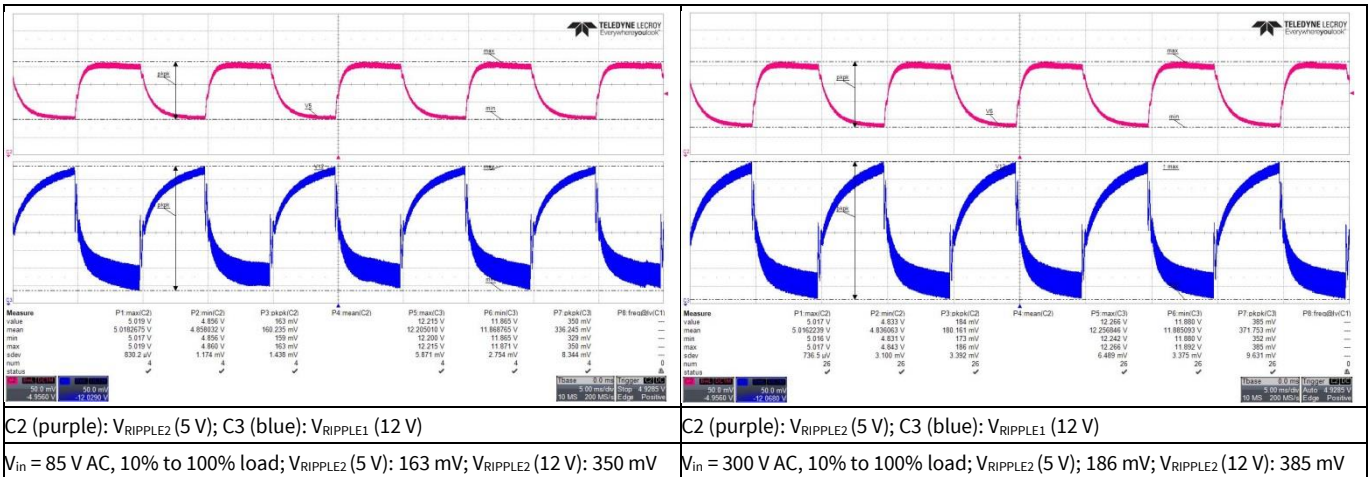
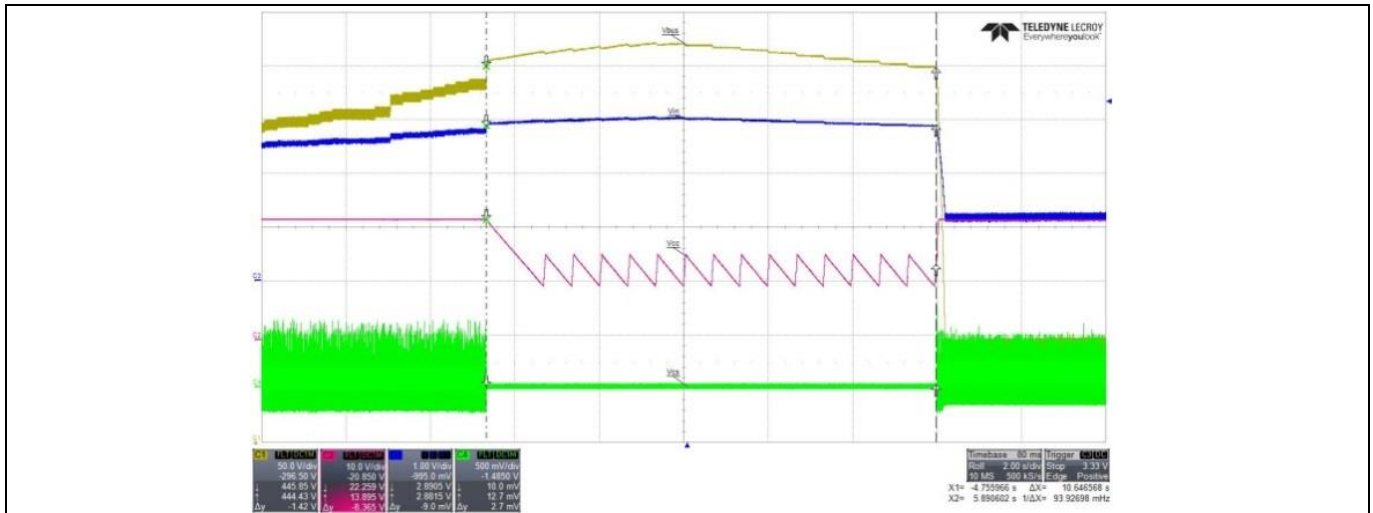

Figure 20 Load transient response

Waveforms

11.7 Line OVP Protection (OVP) (non-switch auto restart)

- Increase AC-line voltage gradually at maximum load until line OVP is detected and then decrease the AC-line until line OVP reset detected.



C1 (yellow): V_{Bus}; C2 (purple): V_{CC}; C3 (blue): V_{VIN}; C4 (green): V_{CS}

Max. load; line OVP triggered: 320 V AC (V_{Bus} > 445 V DC or V_{VIN} > 2.9 V); line OVP reset: 320 V AC (V_{Bus} < 445 V DC or V_{VIN} < 2.9 V)

Figure 21 Line OVP

11.8 Brown-in/Brown-out protection (non-switch auto restart)

- Increase AC-line voltage gradually at 1 W load (5 V at 6 mA and 12 V at 80 mA) until the system starts up (brown-in) and then reduce the AC-line until the system shut-down (brown-out)

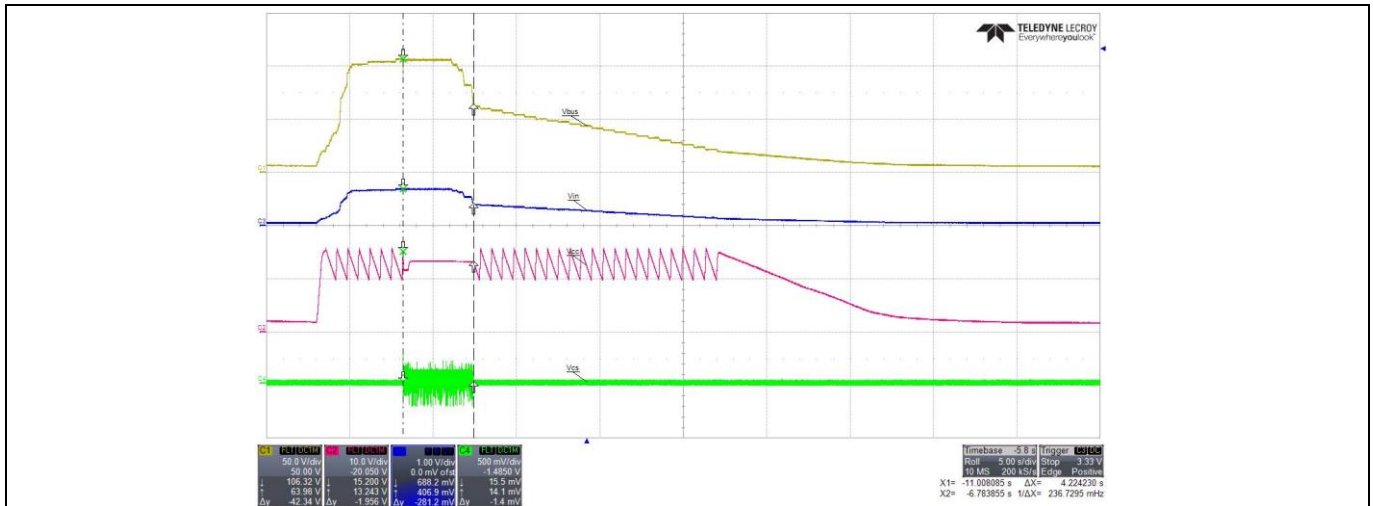

C1 (yellow): V_{Bus}; C2 (purple): V_{CC}; C3 (blue): V_{VIN}; C4 (green): V_{CS}

1 W load; brown-in: 75 V AC (V_{Bus} > 106 V DC or V_{VIN} > 0.66 V); brown-out: 43 V AC (V_{Bus} < 63 V DC or V_{VIN} < 0.4 V)

Figure 22 Brown-in/Brown-out protection

Waveforms

11.9 Over-load protection (odd-skip auto restart)

- V_{OUT1} (12 V) short-to-GND at 85 V AC

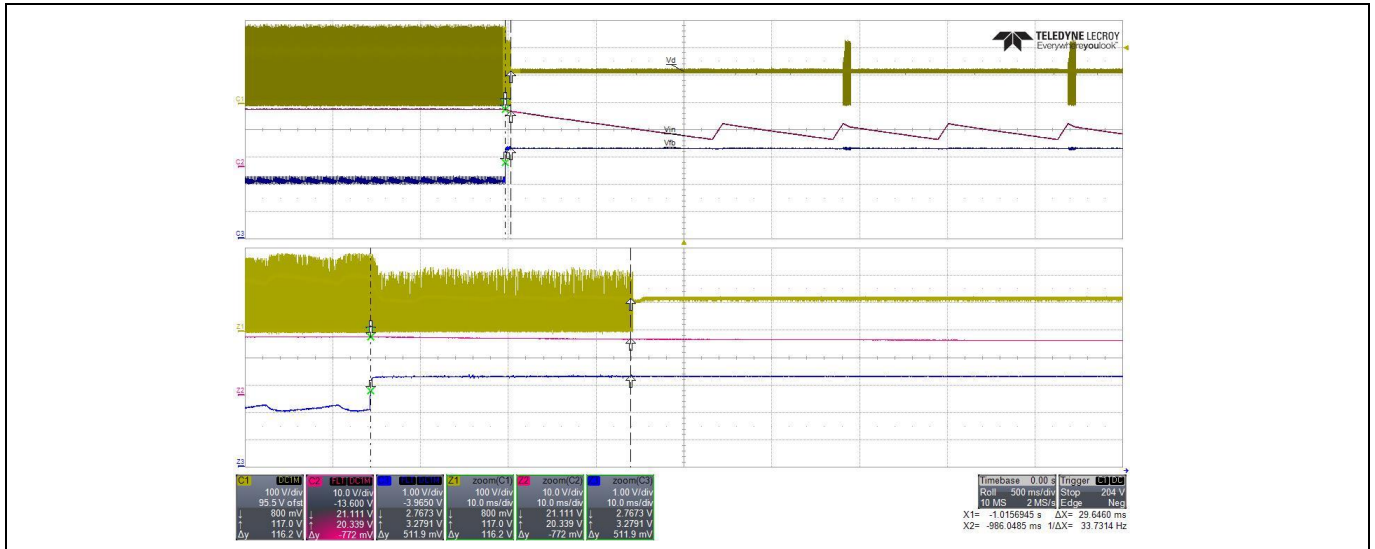

C1 (yellow): V_{drain} ; C2 (purple): V_{CC} ; C3 (blue): V_{FB}

V_{IN} = 85 V AC; system enters OLP auto-restart mode

Figure 23 Over-load protection (OLP)

11.10 Output OV protection (odd-skip auto restart)

- Short resistor R26 during system operation at no load at 85 V AC

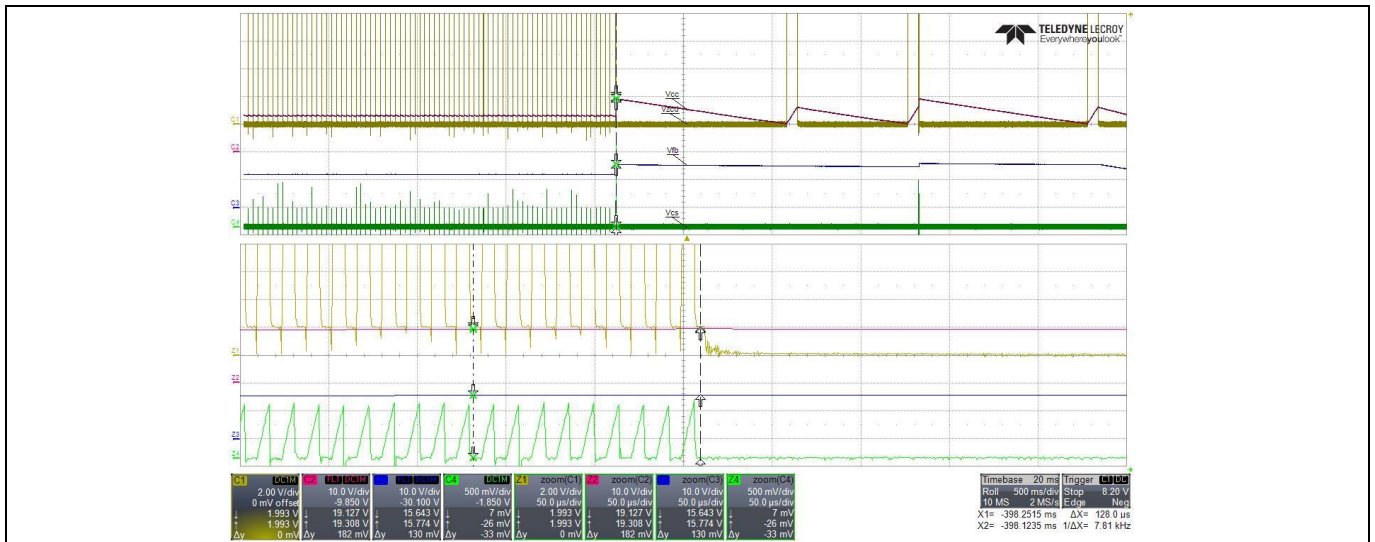

C1 (yellow): V_{CC} ; C2 (purple): V_{CC} ; C3 (blue): V_{OUT1} (12 V); C4 (green): V_{CS}

V_{IN} = 85 V AC, no load; when V_{OUT1} (12 V) increase to hit 15 V, the system enters output OVP auto-restart mode

Figure 24 Output OV protection

Waveforms

11.11 Conducted emissions (EN 55022 class B)

Equipment: Schaffner SMR4503 (receiver); standard: EN 55022 (CISPR 22) class B; test conditions: $V_{IN} = 115\text{ V AC}$ and 230 V AC , load: 33 W ($12\text{ V } 4.5\ \Omega$, $5\text{ V } 25\ \Omega$).

- Pass conducted emissions EN 55022 (CISPR 22) class B with greater than 12 dB margin for quasi-peak measurement at low-line (115 V AC) and greater than 6 dB margin for quasi-peak measurement at high-line (230 V AC).

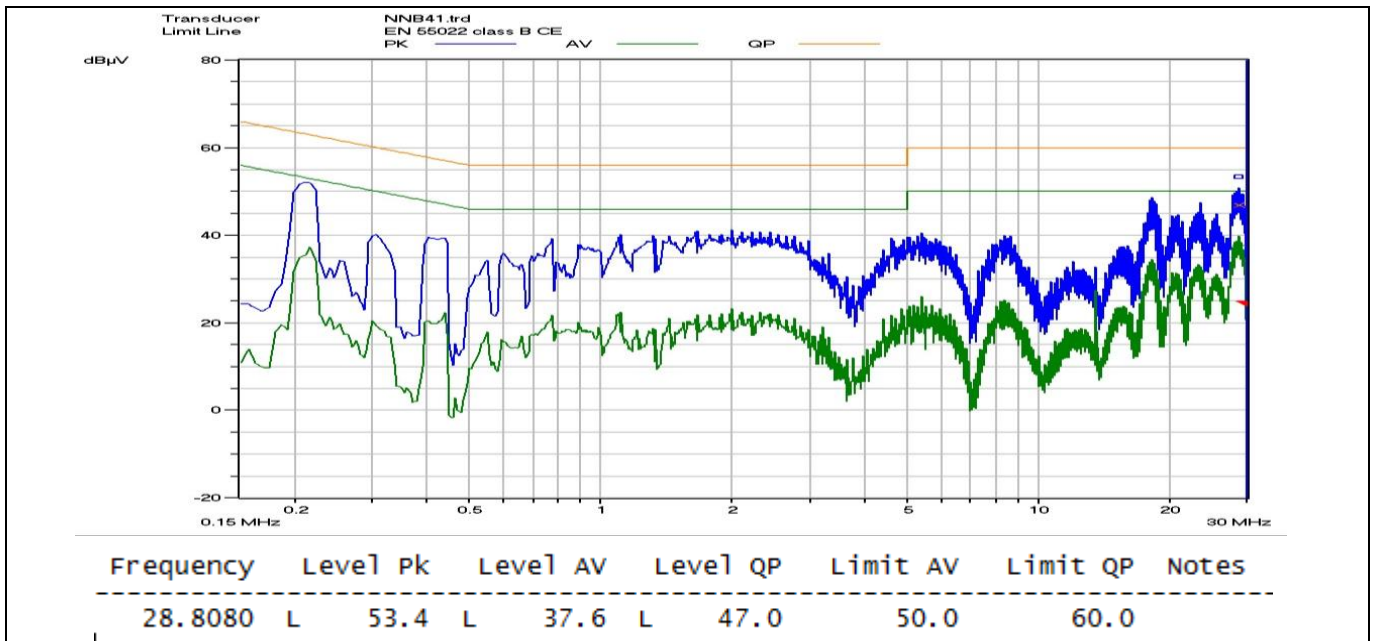

Figure 25 Conducted emissions at 115 V AC line and 33 W load - > 12 dB margin

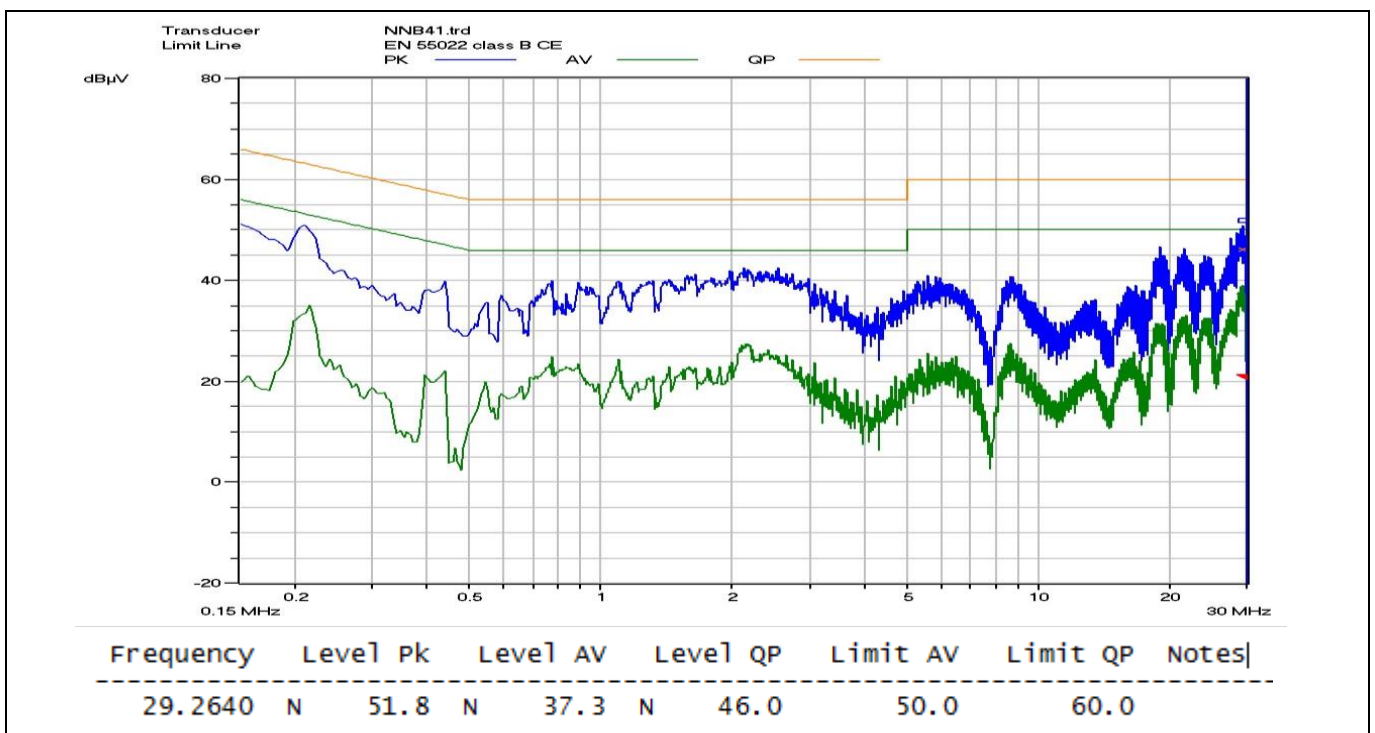

Figure 26 Conducted emissions at 115 V AC neutral and 33 W load - > 15 dB margin

Waveforms

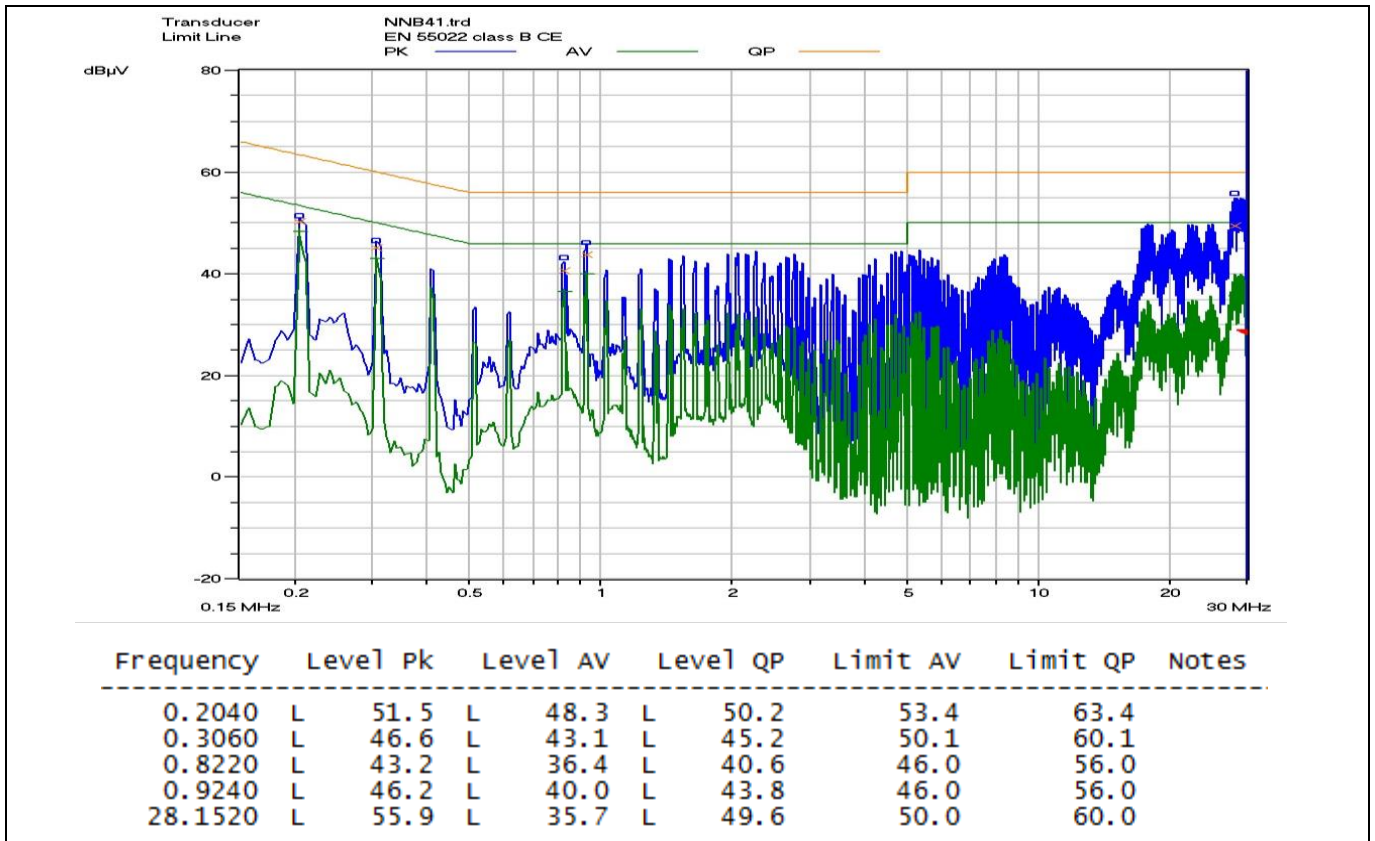

Figure 27 Conducted emissions at 230 V AC line and 33 W load - > 6 dB margin

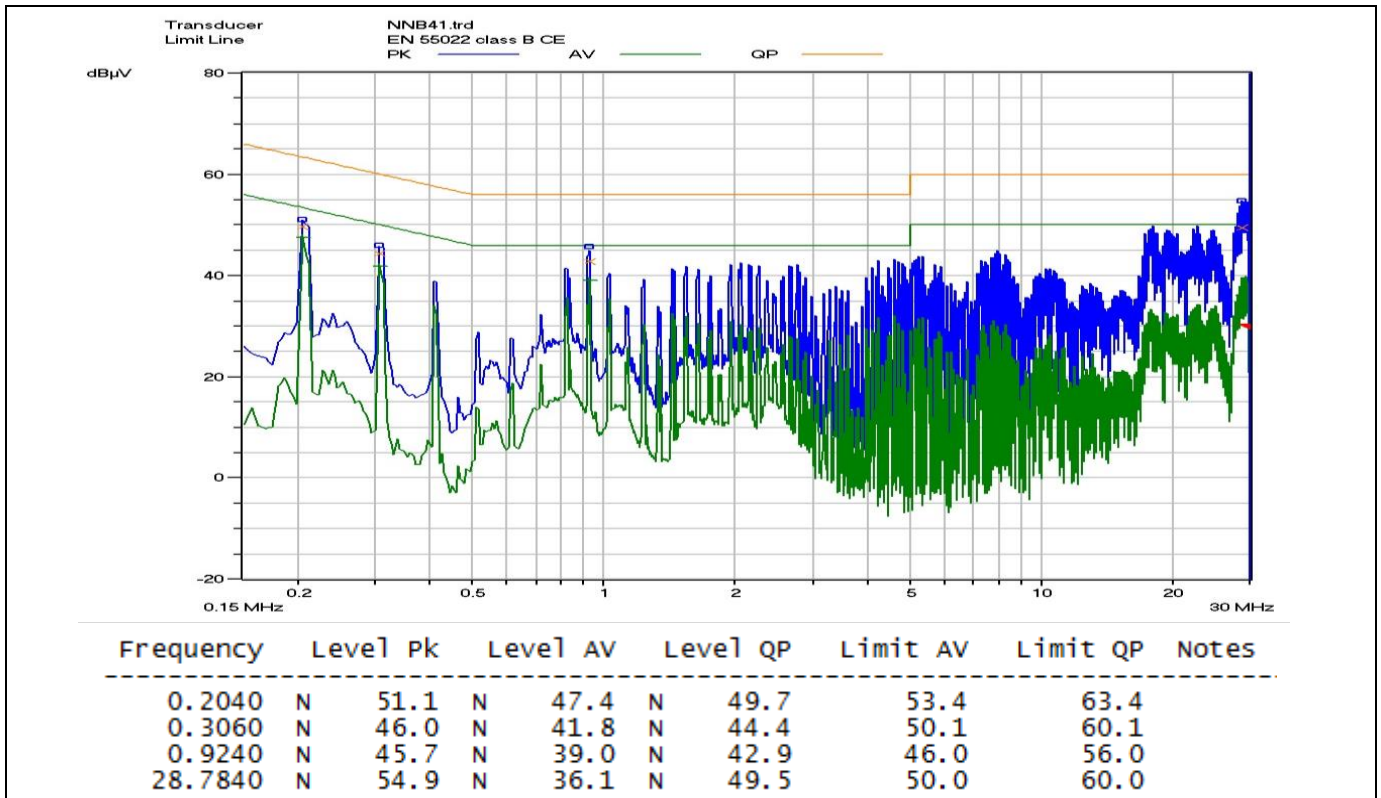

Figure 28 Conducted emissions at 230 V AC neutral and 33 W load - > 7 dB margin

Waveforms

11.12 ESD immunity (EN 61000-4-2)

This system was subjected to a ± 10 kV ESD test according to EN 61000-4-2 for both contact and air discharge. A test failure was defined as non-recoverable.

- Air discharge: pass ± 10 kV; contact discharge: pass ± 10 kV.

Table 6 System ESD test result

Description	ESD test	level	Number of strikes				Test result
			+V _{OUT1}	-V _{OUT1}	+V _{OUT2}	-V _{OUT2}	
115 V AC, 33 W (12 V 4.5 Ω , 5 V 25 Ω)	Contact	+10 kV	10	10	10	10	PASS
		-10 kV	10	10	10	10	PASS
	Air	+10 kV	10	10	10	10	PASS
		-10 kV	10	10	10	10	PASS
230 V AC, 33 W (12 V 4.5 Ω , 5 V 25 Ω)	Contact	+10 kV	10	10	10	10	PASS
		-10 kV	10	10	10	10	PASS
	Air	+10 kV	10	10	10	10	PASS
		-10 kV	10	10	10	10	PASS

11.13 Surge immunity (EN 61000-4-5)

This system was subjected to a surge immunity test (± 2 kV DM and ± 4 kV CM) according to EN 61000-4-5. A test failure was defined as a non-recoverable.

- DM: pass ± 2 kV; CM: pass ± 4 kV.

Table 7 System surge immunity test result

Description	Test	Level		Number of strikes				Test result
				0°	90°	180°	270°	
115 V AC, 33 W (12 V 4.5 Ω , 5 V 25 Ω)	DM	+2 kV	L \rightarrow N	3	3	3	3	PASS
		-2 kV	L \rightarrow N	3	3	3	3	PASS
	CM	+4 kV	L \rightarrow G	3	3	3	3	PASS
		+4 kV	N \rightarrow G	3	3	3	3	PASS
		-4 kV	L \rightarrow G	3	3	3	3	PASS
		-4 kV	N \rightarrow G	3	3	3	3	PASS
230 V AC, 33 W (12 V 4.5 Ω , 5 V 25 Ω)	DM	+2 kV	L \rightarrow N	3	3	3	3	PASS
		-2 kV	L \rightarrow N	3	3	3	3	PASS
	CM	+4 kV	L \rightarrow G	3	3	3	3	PASS
		+4 kV	N \rightarrow G	3	3	3	3	PASS
		-4 kV	L \rightarrow G	3	3	3	3	PASS
		-4 kV	N \rightarrow G	3	3	3	3	PASS

12 Appendix A: Transformer design and spreadsheet [3]

Design procedure for QR Flyback converter using Q5 Coolset 5QRxxxxAx (version 1.1)

Project:	ICE5QR1070AZ
Application:	85 ~ 300 V AC and 33 W (12 V, 2.66 A; 5 V, 0.2 A) dual output, dual FB
CoolSET™ M ₁ :	ICE5QR1070AZ
Date:	2017 Feb 15
Revision:	0.1

Enter design variables in orange colored cells

Read design results in green colored cells

Equation numbers are according to the AN

		Unit	Value
Input	Minimum AC input voltage	V_{ACMin}	[V] 85
Input	Maximum AC input voltage	V_{ACMax}	[V] 300
Input	Line frequency	f_{AC}	[Hz] 60
Input	Bus capacitor (C13) DC ripple voltage	$V_{DCRIPPLE}$	[V] 28
Input	Output voltage 1	V_{OUT1}	[V] 12
Input	Output current 1	I_{OUT1}	[A] 2.66
Input	Forward voltage of output diode (D21)	$V_{FDiode1}$	[V] 0.6
Input	Output voltage 2	V_{OUT2}	[V] 5
Input	Output current 2	I_{OUT2}	[A] 0.2
Input	Forward voltage of output diode (D22)	$V_{FDiode2}$	[V] 0.6
Input	Maximum output power for start-up, transient response and OLP	P_{OUTMax}	[W] 33
Input	Nominal output power	P_{OUTNor}	[W] 32.92
Input	Minimum output power	P_{OUTMin}	[W] 3.2
Input	Efficiency	η	0.885
Result	Drain-to-source capacitance of MOSFET (including $C_{o(er)}$ of MOSFET)	$C_{DS}+C_{o(er)}$	[pF] 35.00

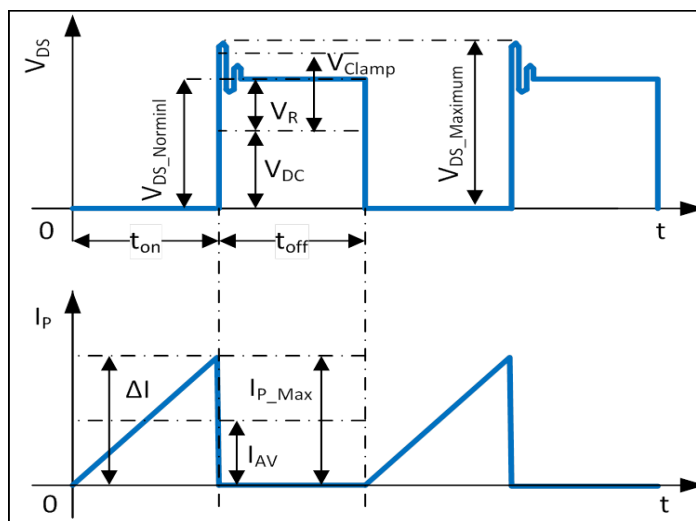

Input	Reflection voltage	V_R	[V] 90
Input	V_{CC} voltage	V_{VCC}	[V] 14
Input	Forward voltage of V_{CC} diode (D12)	$V_{FDiodeVCC}$	[V] 0.6
Input	CoolSET® -2Q	CoolSET™ -Q5	ICE5QR1070AZ
Input	Low-line min. switching frequency	f_s	[Hz] 70000
Input	Targeted max. drain source voltage	V_{DSMax}	[V] 600
Input	Max. ambient temperature	T_a	[°C] 50
Diode bridge (BR1)			
Result	Eq 1	P_{INMax}	[W] 37.29

33 W auxiliary SMPS for refrigerator using ICE5QR1070AZ

REF_5QR1070AZ_33W1



Appendix A: Transformer design and spreadsheet [3]

Result	Eq 2	I_{AC_RMS}	[A]	0.731
Result	Eq 3	$V_{DC_Max_Pk}$	[V]	424.26
Result	Eq 4	$V_{DC_Min_Pk}$	[V]	120.21
Result	Eq 10	V_{DC_Min}	[V]	92.47
Result	Eq 6	T_D	[ms]	6.49
Result	Eq 7	W_{IN}	[Ws]	0.24
Result	Eq11	D_{Max}		0.4932
Input capacitor (C13)				
Result	Eq 8	C_{IN} (C13)	[uF]	81.32
Input	Select input capacitor	C_{IN} (C13)	[uF]	82
Transformer (TR1)				
Result	Eq 12	L_P	[H]	3.786E-04
Result	Eq 13	I_{AV}	[A]	0.82
Result	Eq 14	ΔI	[A]	1.721
Result	Eq 15	I_{P_Max}	[A]	1.68
Result	Eq 16	I_{valley}	[A]	0.0
Result	Eq 17	I_{P_RMS}	[A]	0.67
Select core type				
Input	Select core type			3
		Core type		E30/15/7
		Core material		N87
	Maximum flux density	B_{Max}	[T]	0.3
	Effective magnetic cross-section	A_e	[mm ²]	60
	Bobbin width	BW	[mm]	17.5
	Winding cross-section	A_N	[mm ²]	90
	Average length of turn	l_N	[mm]	56
Winding calculation				
Result	Eq 18	N_P	Turns	35.29
Input	Choose number of primary turns	N_P	Turns	50
Result	Eq 19	N_{S1}	Turns	7.00
Input	Choose number of secondary turns	N_{S1}	Turns	7
Result	Eq 19	N_{S2}	Turns	3.11
Input	Choose number of secondary turns	N_{S2}	Turns	3
Result	Eq 20	N_{VCC}	Turns	8.11
Input	Choose number of auxiliary turns	N_{VCC}	Turns	8
Result	Auxiliary supply voltage (Eq 21)	V_{VCC}	[V]	13.80
Post calculation				
Result	Eq 23	V_R	[V]	90.00
Result	Eq 24	D_{Max}		0.49
Result	Eq 25	D_{Max}'		0.51
Result	Eq 26	B_{Max}	[T]	0.212
CS resistor(R14)				
Input	CS threshold value from datasheet	V_{csth}	[V]	1
Result	Eq 21	R_{Sense} (R14)	[Ω]	0.596
Result	Eq 22	P_{SR}	[W]	0.27
Input	PWM-OP gain from datasheet	G_{PWM}		2.05
Result	Eq 94	Z_{PWM}	[V/A]	1.22
Transformer winding design				
Input	Margin according to safety standard	M	[mm]	4.2
Input	Copper space factor	f_{Cu}		0.3
Primary				
Input	Insulation thickness	INS	[mm]	0.02
Result	Eq 32	A_p (area of primary wire)	[mm ²]	0.14
Result	Eq 36	dia. (diameter of primary wire)	[mm]	0.42
Result	Eq 35	AWG		26
Input	Selected wire size	AWG		26
Input	Number of parallel wires	N_p		1
Result	Eq 37	dia. (diameter of primary wire)	[mm]	0.41
Result	Eq 38	(eff. copper area of primary)	[mm ²]	0.1303
Result	Eq 39	S_p (primary current density)	[A/mm ²]	5.16

33 W auxiliary SMPS for refrigerator using ICE5QR1070AZ

REF_5QR1070AZ_33W1



Appendix A: Transformer design and spreadsheet [3]

Result	Eq 30	BW_e (effective bobbin width)	[mm]	9.1
Result	Eq 40	Od_p (diameter of primary wire including insulation)	[mm]	0.45
Result	Eq 41	NL_P (max. primary turns/layer)	Turns/layer	20
Result	Eq 42	Ln_P (primary layers)	Layers	3
Secondary				
Input	Insulation thickness	INS	[mm]	0.02
Result	Eq 33	A_s (area of secondary wire)	[mm ²]	0.90
Result	Eq 36	Dia. (diameter of secondary wire)	[mm]	1.07
Result	Eq 35	AWG		18
Input	Selected wire size	AWG		26
Input	Number of parallel wires	N_p		5
Result	Eq 37	Dia. (diameter of secondary wire)	[mm]	0.41
Result	Eq 38	(eff. copper area of secondary)	[mm ²]	0.6515
Result	Eq 39	S_s (secondary current density)	[A/mm ²]	7.24
Result	Eq 30	BW_e (effective bobbin width)	[mm]	9.1
Result	Eq 40	Od_s (diameter of secondary wire including insulation)	[mm]	0.45
Result	Eq 41	NL_s (max. secondary turns/layer)	Turns/layer	4
Result	Eq 42	Ln_s (secondary layers)	Layers	2
Leakage inductance				
Input		Leakage Inductance in % of L_p	[%]	0.48
Result	Eq 45	L_{LK}	[H]	1.82E-06
RCD clamper circuit (D11, R11 and C15)				
Result	Eq 44	V_{clamp}	[V]	85.74
Result	Eq 46	C_{clamp} (C15)	[nF]	0.3
Input	Selected C_{clamp} capacitor value	C_{clamp} (C15)	[nF]	1
Result	Eq 47	R_{clamp} (R11)	[kΩ]	127.2
Input	Selected R_{clamp} value	R_{clamp} (R11)	[kΩ]	68
Output and V_{CC} diodes (D21, D22 and D12)				
Result	Eq 27	K_{L1} (load factor)		0.97
Result	Eq 43a	$V_{RDiode1}$ (for output diode D21)	[V]	71.40
Result	Eq 28	I_{S_Max1}	[A]	11.62
Result	Eq 29	I_{S_RMS1}	[A]	4.72
Result	Eq 43a	$V_{RDiode2}$ (for output diode D22)	[V]	30.46
Result	Eq 27	K_{L2} (load factor)		0.03
Result	Eq 28	I_{S_Max2}	[A]	0.85
Result	Eq 29	I_{S_RMS2}	[A]	0.33
Result	Eq 43b	V_{RDiode} (for V_{CC} diode)	[V]	81.88
Output capacitors (C22 and C23)				
Input	Max. voltage overshoot at output capacitor (C22, C23)	ΔV_{OUT1}	[V]	0.5
Input	Number of clock periods	n_{cp}		20
Result	Eq 49	$I_{RIPPLE1}$	[A]	3.90
Result	Eq 50	C_{OUT1}	[uF]	1520
Zero frequency of output capacitors (C22 and C23) and associated ESR				
Input	Selected output capacitor value	C22	[uF]	1000
Input	ESR (Z_{Max}) value from datasheet @ 100 kHz	ESR	[Ω]	0.028
Input	I_{ACMax} value from datasheet @ 100 kHz	I_{ACMax}	[Arms]	1.76
Input	Number of parallel capacitors	n_c		2
Result	Eq 51	f_{ZCOUT1}	[kHz]	5.68
Ripple voltage first stage				
Result	Eq 52	$V_{RIPPLE1}$	[V]	0.16
Input	Selected LC filter inductor value	L_{OUT1} (L21)	[uH]	2.2
Calculating the necessary capacitance for the output LC-filter (C24)				
Result	Eq 53	C_{LC1} (C24)	[uF]	356.4
Input	Selected output inductance value	C_{LC1} (C24)	[uF]	470
Result	Eq 54	f_{LC1}	[kHz]	4.95
Ripple voltage 2nd stage				
Result	Eq 55	$V_{RIPPLE2}$	[mV]	0.81

33 W auxiliary SMPS for refrigerator using ICE5QR1070AZ

REF_5QR1070AZ_33W1



Appendix A: Transformer design and spreadsheet [3]

Output capacitor (C28 & C29)				
Input	Max. voltage overshoot at output capacitors (C28, C29)	ΔV_{Out2}	[V]	0.25
Input	Number of clock periods	n_{cp}		20
Result	Eq 49	$I_{RIPPLE2}$	[A]	0.27
Result	Eq 50	C_{OUT2}	[uF]	229
Zero frequency of output capacitor (C28 and C29) and associated ESR				
Input	Selected output capacitor value	C28	[uF]	330
Input	ESR (Z_{max}) value from datasheet @ 100 kHz	ESR	[Ω]	0.094
Input	I_{ACMax} value from datasheet @ 100 kHz	I_{ACMax}	[Arms]	0.54
Input	Number of parallel capacitors	n_c		1
Result	Eq 51	f_{ZCOUT2}	[KHz]	5.13
Ripple voltage 1st. stage				
Result	Eq 52	$V_{RIPPLE1}$	[V]	0.08
Input	Selected LC filter inductor value	L_{OUT2} (L22)	[uH]	4.7
Calculating the needed capacitance for the output LC-filter (C24)				
Result	Eq 53	C_{LC2} (C210)	[uF]	204.7
Input	Selected output inductance value	C_{LC2} (C210)	[uF]	330
Result	Eq 54	f_{LC2}	[kHz]	4.04
Ripple voltage 2nd. stage				
Result	Eq 55	$V_{RIPPLE2}$	[mV]	0.27
Soft-Start Time				
Input	Selected soft-start time from datasheet	$t_{softstart}$	[ms]	12
V_{CC} capacitor (C16) and start-up time				
Input	Selected $I_{VCC,Charge3}$ from datasheet	$I_{VCC,Charge3}$	[mA]	3
Input	Selected $V_{VCCchys}$ from datasheet	$V_{VCCchys}$	[mV]	6
Result	Eq 56A	C_{VCC}	[uF]	6.00
Input	Selected V_{CC} capacitor	C_{VCC} (C16)	[uF]	22
Input	Selected $V_{VCC,STG}$ from datasheet	$V_{VCC,STG}$	[V]	1.1
Input	Selected $I_{VCC,Charge1}$ from datasheet	$I_{VCC,Charge1}$	[mA]	0.2
Input	Selected $V_{VCC,ON}$ from datasheet	$V_{VCC,ON}$	[V]	16
Result	Eq 56B	$t_{startUp}$	[ms]	238.33
Calculation of losses				
Input diode bridge				
Result	Eq 57	P_{DIN}	[W]	1.46
Transformer copper losses				
Result	Eq 58	R_{PCu}	[m Ω]	369.59
Result	Eq 58	R_{SCu1}	[m Ω]	10.35
Result	Eq 58	R_{SCu2}	[m Ω]	4.44
Result	Eq 59	P_{PCu}	[mW]	166.84
Result	Eq 60	P_{SCu1}	[mW]	230.24
Result	Eq 60	P_{SCu2}	[mW]	0.49
Result	Eq 61	P_{Cu}	[W]	0.3976
Output rectifier diode				
Result	Eq 62	P_{OUT_DIODE1} (D21)	[W]	2.83
Result	Eq 62	P_{OUT_DIODE2} (D22)	[W]	0.20
RCD clamper circuit				
Result	Eq 63	P_{clamp}	[W]	0.37
MOSFET				
Input	R_{DSon} from datasheet	R_{DSon} @ $T_J=125^\circ C$	[Ω]	1.85
Input	$C_{o(er)}$ from datasheet	$C_{o(er)}$	[pF]	13
Input	External drain-to-source capacitance of MOSFET	C_{ds}	[pF]	22
MOSFET losses @ $V_{ACMin} + P_{Max}$				
Result	Eq 65	P_{SON}	[W]	0.000007498
Result	Eq 66	P_{cond}	[W]	0.8351
Result	Eq 67	MOSFET Losses	[W]	0.8351
MOSFET losses @ $V_{ACMax} + P_{Max}$				
Result	Eq 68	P_{SON}	[W]	0.1779
Result	Eq 69	P_{cond}	[W]	0.2366
Result	Eq 70	MOSFET losses	[W]	0.4146
Temperature Calculation				

33 W auxiliary SMPS for refrigerator using ICE5QR1070AZ

REF_5QR1070AZ_33W1



Appendix A: Transformer design and spreadsheet [3]

Input	Enter MOSFET losses	MOSFET losses	[W]	0.83
Input	Enter thermal resistance junction – ambient	R_{th}	[°K/W]	100.0
Result	Eq 74	ΔT	[°K]	83.2
Result	Eq 75	T_{jmax}	[°C]	133.2
Controller				
Result	I_{vcc,Normal}XV_{vcc}	Controller losses	[W]	0.0124
Sum of losses				
Result	Eq 77	P_{Losses}	[W]	5.90
Efficiency after losses				
Result	Eq 78	η_L		0.8483
Calculation of the regulation loop (R22, R23, R24, R25, R25A, R26, C25, C26)				
Input	Minimum current for TL431 reference	I_{kAmin}	[mA]	1
Input	Optocoupler gain	G_C		1
Input	Maximum current for optocoupler diode	I_{Fmax}	[mA]	10
Input	TL431 reference voltage	V_{REF_TL}	[V]	2.5
Input	Weighted factor of V_{OUT1} (important factor of V_{OUT1})	W₁		0.6
Input	Weighted factor of V_{OUT2} (important factor of V_{OUT2})	W₂		0.4
Input	Current for FB resistor R26	I_{R26}	[mA]	1
Input	0 db crossover frequency	f_g	[kHz]	3
Result	Eq 112	R26	[kΩ]	2.5
Input	Selected value of R25	R26	[kΩ]	2.5
Result	Eq 112A	R25	[kΩ]	15.83
Input	Selected value of R25	R25	[kΩ]	16
Result	Eq 112B	R25A	[kΩ]	6.25
Input	Selected value of R25A	R25A	[kΩ]	6.2
Result	Eq 82	R22	[kΩ]	0.8250
Input	Selected value of R22	R22	[kΩ]	0.82
Input	V_{REF} from datasheet	V_{REF}	[V]	3.3
Input	V_{FB,OLP} from datasheet(over-load/open-loop detection limit at FB pin)	V_{FB,OLP}	[V]	2.75
Input	R_{FB} from datasheet	R_{FB}	[kΩ]	15
Result	Eq 83	R23	[kΩ]	1.28
Input	Selected value of R23	R23	[kΩ]	1.2
Result	Eq 112A	V_{OUT1,RL}	[V]	12.10
Result	Eq 112B	V_{OUT2,RL}	[V]	4.98
Result	Eq 85	K_{FB}		18.29
Result	Eq 86	G_{FB}	[db]	25.25
Result	Eq 87	K_{Vd}		0.14
Result	Eq 88	G_{Vd}	[db]	-17.38
Result	Eq 89	R_{LH}	[Ω]	4.36
Result	Eq 90	R_{LL}	[Ω]	45.00
Result	Eq 91	f_{OH}	[Hz]	36.47
Result	Eq 92	f_{OL}	[Hz]	3.54
Result	Eq 93	f_{OM}	[Hz]	11.36
Result	Eq 95	F_{PWR} (fg)		0.071
Result	Eq 96	G_{PWR} (fg)	[db]	-22.95
Result	Eq 99	Gr	[db]	15.091
Result	Eq 100	R24	[kΩ]	12.29
Input	Selected value of R24	R24	[kΩ]	12
Result	Eq 101	C26	[nF]	4.421
Input	Selected value of C26	C26	[nF]	1
Result	Eq 102	C25	[nF]	1166.75
Input	Selected value of C25	C25	[nF]	220
ZCD and output OVP calculation				
Input	Designed V_{OUT_OVP}	V_{OUT_OVP}	[V]	14.5
Input	V_{ZC_OVP_MIN} from datasheet	V_{ZC_OVP_MIN}	[V]	1.9
Input	R_{ZCD_MIN} from datasheet	R_{ZCD}	[kΩ]	3
Result	Eq 103	R_{ZC}(R15)	[kΩ]	24.25
Input	Selected value of R15	R_{ZC}(R15)	[kOhm]	24
Input	f_{OSC2} by measurement	f_{OSC2}	[kHz]	1100
Result	Eq 104	C_{ZC} (C19)	[pF]	66

33 W auxiliary SMPS for refrigerator using ICE5QR1070AZ

REF_5QR1070AZ_33W1



Appendix A: Transformer design and spreadsheet [3]

Input	Selected value of C_{ZC} (C19)	C_{ZC} (C19)	[pF]	68
Line OVP is the first priority and its associated brown-out, brown-in and line selection				
Input		R_{I1} (R18)	[Ω]	9,000,000
Input		Line OV (V_{OVP_AC})	[V AC]	320
Input		V DC _{RIPPLE}	[V]	28
Result	Eq 105A	R_{I2} (R19)	[Ω]	58,045
Input	Selected value of R19 (R_{I2})	R_{I2} (R19)	[Ω]	59,000
Result	Eq 106	Brown-in voltage ($V_{Brownin_AC}$)	[V AC]	72
Result	Eq 107	Brown-out voltage for full load which considers V DC _{RIPPLE} ($V_{Brownout_AC}$)	[V AC]	63
Result	Eq 107	Brown-out voltage for light load which neglects V DC _{RIPPLE} ($V_{Brownout_AC}$)	[V AC]	43
Result	Eq 108	Line selection threshold with V DC _{RIPPLE} ($V_{VIN} = 1.52$ V)	[V AC]	185
Result	Eq 108	Line selection threshold without V DC _{RIPPLE} ($V_{VIN} = 1.52$ V)	[V AC]	165
Brown-out is the first priority and its associated line OVP and line selection				
Input		R_{I1} (R18)	[Ω]	9,000,000
Input		Brown-in voltage (V_{OVP_AC})	[V AC]	73
Input		V DC _{RIPPLE}	[V]	28
Result	Eq 105B	R_{I2} (R19)	[Ω]	57,907
Input	Selected value of R19 (R_{I2})	R_{I2} (R19)	[Ω]	59,000
Result	Eq 107	Brown-out voltage for full load which considers V DC _{RIPPLE} ($V_{Brownout_AC}$)	[V AC]	63
Result	Eq 107	Brown-out voltage for light load which neglect V DC _{RIPPLE} ($V_{Brownout_AC}$)	[V AC]	43
Result	Eq 114	Line OV (V_{OVP_AC})	[V AC]	315
Result	Eq 108	Line selection threshold with V DC _{RIPPLE} ($V_{VIN} = 1.52$ V)	[V AC]	185
Result	Eq 108	Line selection threshold without V DC _{RIPPLE} ($V_{VIN} = 1.52$ V)	[V AC]	165

Electrical			
Minimum AC voltage		[V]	85
Maximum AC voltage		[V]	300
Maximum input current		[A]	0.44
Minimum DC voltage		[V]	92
Maximum DC voltage		[V]	424
Maximum output power		[W]	33.0
Output voltage		[V]	12.0
Output ripple voltage		[mV]	0.8
Inductor peak current		[A]	1.68
Maximum duty cycle			0.49
Reflected output voltage		[V]	90
Copper losses		[W]	0.40
MOSFET losses		[W]	0.84
Sum losses		[W]	5.90
Efficiency			0.85

Transformer			
Core type			E30/15/7
Core material			N87
Effective core area		[mm ²]	60
Maximum flux density		[mT]	212
Inductance		[μ H]	379
Margin		[mm]	4
Primary turns		Turns	50
Primary copper wire size		AWG	26
Secondary turns (N_{S1})		Turns	7
Secondary copper wire size		AWG	26
Number of parallel secondary wires			5
Secondary turns (N_{S2})		Turns	3
Auxiliary turns		Turns	8
Leakage inductance		[μ H]	1.8

33 W auxiliary SMPS for refrigerator using ICE5QR1070AZ

REF_5QR1070AZ_33W1



Appendix A: Transformer design and spreadsheet [3]

Turns ratio			7.14
Primary layers		Layer	3
Secondary layers		Layer	2

Components			
Input capacitor	C13	[uF]	82.0
Output capacitor	C22	[uF]	1000.0
LC filter capacitor	C24	[uF]	470.0
Output capacitor	C28	[uF]	330.0
LC filter capacitor	C210	[uF]	330.0
LC filter inductor	L21	[uH]	2.2
LC filter inductor	L22	[uH]	4.7
V _{CC} capacitor	C16	[uH]	22.0
ZC capacitor	C19	[pF]	68
ZC resistor	R15	[kΩ]	24
Sense resistor	R14	[Ω]	0.60
Clamping resistor	R11	[kΩ]	68.0
Clamping capacitor	C15	[nF]	1
Voltage divider	R25	[kΩ]	15.8
Voltage divider	R26	[kΩ]	2.5
Regulator component	R22	[kΩ]	0.82
Regulator component	R23	[kΩ]	1.2
Regulator component	R24	[kΩ]	12.0
Regulator component	C25	[nF]	220.0
Regulator component	C26	[nF]	1.00

13 Appendix B: WE transformer specification

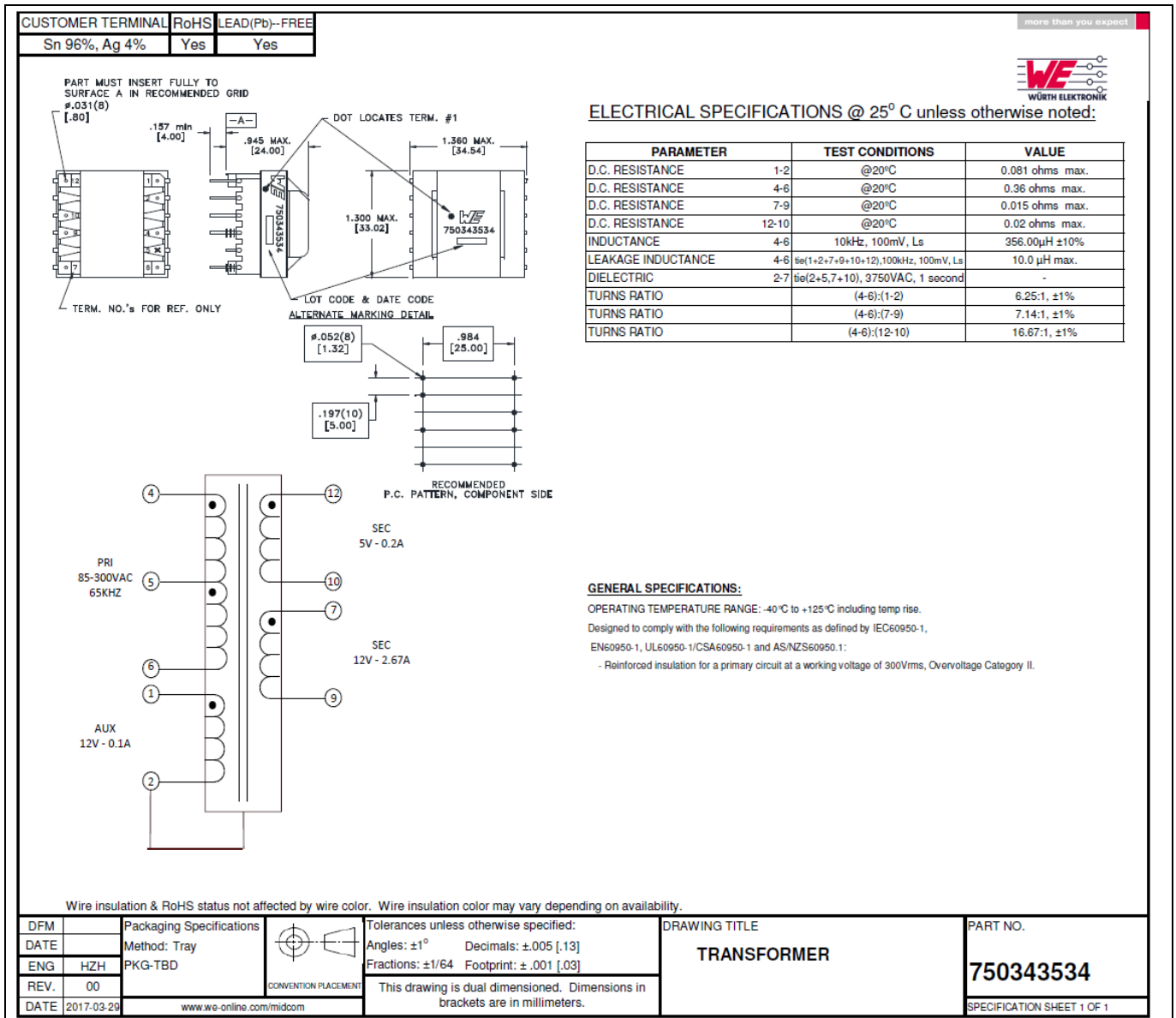

Figure 29 WE transformer specification

References

14 References

- [1] [ICE5QRxxxxAx datasheet, Infineon Technologies AG](#)
- [2] [AN-201609_PL83_026-5th Generation QR Design Guide](#)
- [3] [Calculation Tool Quasi Resonant CoolSET™ Generation 5](#)

Revision history

Major changes since the last revision

Page or reference	Description of changes
-	First release

Trademarks

All referenced product or service names and trademarks are the property of their respective owners.

Edition 2017-09-11

Published by

Infineon Technologies AG

81726 Munich, Germany

© 2017 Infineon Technologies AG.

All Rights Reserved.

Do you have a question about this document?

Email: erratum@infineon.com

Document reference

AN_201702_PL83_008

IMPORTANT NOTICE

The information contained in this application note is given as a hint for the implementation of the product only and shall in no event be regarded as a description or warranty of a certain functionality, condition or quality of the product. Before implementation of the product, the recipient of this application note must verify any function and other technical information given herein in the real application. Infineon Technologies hereby disclaims any and all warranties and liabilities of any kind (including without limitation warranties of non-infringement of intellectual property rights of any third party) with respect to any and all information given in this application note.

The data contained in this document is exclusively intended for technically trained staff. It is the responsibility of customer's technical departments to evaluate the suitability of the product for the intended application and the completeness of the product information given in this document with respect to such application.

For further information on the product, technology, delivery terms and conditions and prices please contact your nearest Infineon Technologies office (www.infineon.com).

WARNINGS

Due to technical requirements products may contain dangerous substances. For information on the types in question please contact your nearest Infineon Technologies office.

Except as otherwise explicitly approved by Infineon Technologies in a written document signed by authorized representatives of Infineon Technologies, Infineon Technologies' products may not be used in any applications where a failure of the product or any consequences of the use thereof can reasonably be expected to result in personal injury.



Компания «ЭлектроПласт» предлагает заключение долгосрочных отношений при поставках импортных электронных компонентов на взаимовыгодных условиях!

Наши преимущества:

- Оперативные поставки широкого спектра электронных компонентов отечественного и импортного производства напрямую от производителей и с крупнейших мировых складов;
- Поставка более 17-ти миллионов наименований электронных компонентов;
- Поставка сложных, дефицитных, либо снятых с производства позиций;
- Оперативные сроки поставки под заказ (от 5 рабочих дней);
- Экспресс доставка в любую точку России;
- Техническая поддержка проекта, помощь в подборе аналогов, поставка прототипов;
- Система менеджмента качества сертифицирована по Международному стандарту ISO 9001;
- Лицензия ФСБ на осуществление работ с использованием сведений, составляющих государственную тайну;
- Поставка специализированных компонентов (Xilinx, Altera, Analog Devices, Intersil, Interpoint, Microsemi, Aeroflex, Peregrine, Syfer, Eurofarad, Texas Instrument, Miteq, Cobham, E2V, MA-COM, Hittite, Mini-Circuits, General Dynamics и др.);

Помимо этого, одним из направлений компании «ЭлектроПласт» является направление «Источники питания». Мы предлагаем Вам помощь Конструкторского отдела:

- Подбор оптимального решения, техническое обоснование при выборе компонента;
- Подбор аналогов;
- Консультации по применению компонента;
- Поставка образцов и прототипов;
- Техническая поддержка проекта;
- Защита от снятия компонента с производства.



Как с нами связаться

Телефон: 8 (812) 309 58 32 (многоканальный)

Факс: 8 (812) 320-02-42

Электронная почта: org@eplast1.ru

Адрес: 198099, г. Санкт-Петербург, ул. Калинина, дом 2, корпус 4, литера А.