

## Install in 22-dia. or 25-dia. Panel Cutout

- Direct opening mechanism to open the circuit when the contact welds ☹.
- Safety lock mechanism prevents operating errors.
- Easy mounting and removal of Switch Blocks using a lever.
- Mount three Switch Units in series to improve wiring efficiency (with non-lighted Switch Units, three Units can be mounted for multiple contacts).
- Finger protection mechanism on Switch Unit provided as a standard feature.
- Install using either round, or forked crimp terminals.
- Oil-resistant to IP65 (non-lighted models)/IP65 (lighted models)
- A lock plate is provided as a standard feature to ensure that the control box and switch are not easily separated.

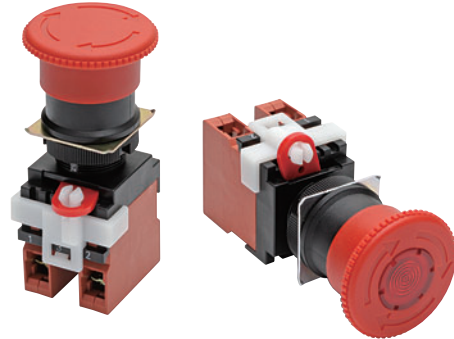

**⚠** Be sure to read the precautions for all pushbutton switches in the *Pushbutton Switches Group Catalog* (Cat. No. X032), as well as the "Safety Precautions" on page 16.

## Model Number Structure

**Model Number Legend (Completely Assembled)**..... Shipped as a set which includes the Operation Unit, Lamp (lighted models only), and Switch.

A22E **1** **L** - **2** **M** - **3** **24A** - **4** **01** - **5** **□**

### 1. Lighted/Non-lighted

Code	Description
None	Non-lighted
L	Lighted *

\* Lighted Emergency Stop Switches are available only for the medium (M) push-lock turn-reset models.

### 2. Head Size

Code	Size	Description
MP	Medium 40 dia.	Push-pull
LP	Large 60 dia.	
S	Small 30 dia.	Push-lock turn-reset
M	Medium 40 dia.	
L	Large 60 dia.	
SK	Small 30 dia.	Push-lock key reset
MK	Medium 40 dia.	

### 3. Light Source Without Voltage Reduction Unit

Code	Description	Operating Voltage
None	Non-lighted	---
6A	LED	6 VAC/VDC
12A		12 VAC/VDC
24A		24 VAC/VDC

### With Voltage Reduction Unit

Code	Description	Operating Voltage
T1	LED	100 VAC
T2		200 VAC

Equipped with 24-VAC/DC LED.

### 4. Contacts

Code	Description
01	SPST-NC
11	SPST-NO + SPST-NC
02	DPST-NC
12	DPST-NC + SPST-NO
03	TPST-NC







### 5. Configuration

Code	Configuration
None	Switch only
B	Switch with Integrated Control Box

## Ordering Information

### List of Models (Completely Assembled)

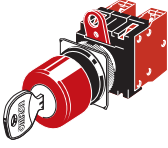

#### Non-lighted Models

Operating		Contact Configuration	Set Model	Color of cap
Appearance				
40-dia. head Medium Push-pull A22E-MP		SPST-NC	A22E-MP-01	Red
		SPST-NO/SPST-NC	A22E-MP-11	
		DPST-NC	A22E-MP-02	
60-dia. head Large Push-pull A22E-LP		SPST-NC	A22E-LP-01	
		SPST-NO/SPST-NC	A22E-LP-11	
		DPST-NC	A22E-LP-02	
30-dia. head Small Push-lock Turn-reset A22E-S		SPST-NC	A22E-S-01 *	
		SPST-NO/SPST-NC	A22E-S-11 *	
		DPST-NC	A22E-S-02 *	
		DPST-NC + SPST-NO	A22E-S-12 *	
		TPST-NC	A22E-S-03 *	
40-dia. head Medium Push-lock Turn-reset A22E-M		SPST-NC	A22E-M-01 *	
		SPST-NO/SPST-NC	A22E-M-11 *	
		DPST-NC	A22E-M-02 *	
		DPST-NC + SPST-NO	A22E-M-12 *	
		TPST-NC	A22E-M-03 *	
60-dia. head Large Push-lock Turn-reset A22E-L		SPST-NC	A22E-L-01 *	
		SPST-NO/SPST-NC	A22E-L-11 *	
		DPST-NC	A22E-L-02 *	
30-dia. head Small Push-lock Key-reset A22E-SK		SPST-NC	A22E-SK-01	
		SPST-NO/SPST-NC	A22E-SK-11	
		DPST-NC	A22E-SK-02	
40-dia. head Medium Push-lock Key-reset A22E-MK		SPST-NC	A22E-MK-01	
		SPST-NO/SPST-NC	A22E-MK-11	
		DPST-NC	A22E-MK-02	

\* Models with Korean S-mark certification.

**Note:** 1. Yellow cap models are also available (not for emergency stop use). Contact your OMRON representative.  
2. The Operation Unit of A22E except models with EMO/EMS indication is red. (The engraved mark is not white.)

#### With EMO/EMS Indication (non-lighted)

Operating		Contact Configuration	Set Model	Color of cap
Appearance				
40-dia. head Medium Push-lock Turn-reset With EMO Indication		SPST-NC	A22E-M-01-EMO *	Red
		SPST-NO/SPST-NC	A22E-M-11-EMO *	
		DPST-NC	A22E-M-02-EMO *	
		DPST-NC + SPST-NO	A22E-M-12-EMO *	
		TPST-NC	A22E-M-03-EMO *	
40-dia. head Medium Push-lock Turn-reset With EMS Indication		SPST-NC	A22E-M-01-EMS *	
		SPST-NO/SPST-NC	A22E-M-11-EMS *	
		DPST-NC	A22E-M-02-EMS *	
		DPST-NC + SPST-NO	A22E-M-12-EMS *	
		TPST-NC	A22E-M-03-EMS *	

\* Models with Korean S-mark certification.

**Note:** The colors of switch blocks are the followings:  
SPST-NO: black  
SPST-NC: red  
The above illustration shows the DPST-NC classification.

## Lighted Models

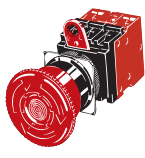
Appearance	Operating			Push-lock turn-reset system	Color of cap
	Contact configuration	Lighting	Rated voltage	Set Model	
40-dia. head Push-lock Turn-reset without Voltage Reduction Unit A22E 	SPST-NC	LED	6 VAC/VDC	A22EL-M-6A-01 *	Red
			12 VAC/VDC	A22EL-M-12A-01 *	
			24 VAC/VDC	A22EL-M-24A-01 *	
	SPST-NO/SPST-NC		6 VAC/VDC	A22EL-M-6A-11 *	
			12 VAC/VDC	A22EL-M-12A-11 *	
			24 VAC/VDC	A22EL-M-24A-11 *	
	DPST-NC		6 VAC/VDC	A22EL-M-6A-02 *	
			12 VAC/VDC	A22EL-M-12A-02 *	
			24 VAC/VDC	A22EL-M-24A-02 *	
40-dia. head Push-lock Turn-reset with Voltage Reduction Unit A22E 	SPST-NC	100 VAC	A22EL-M-T1-01		
		200 VAC	A22EL-M-T2-01		
	SPST-NO/SPST-NC	100 VAC	A22EL-M-T1-11		
		200 VAC	A22EL-M-T2-11		
	DPST-NC	100 VAC	A22EL-M-T1-02		
		200 VAC	A22EL-M-T2-02		

\* Models with Korean S-mark certification.

**Note:** The Operation Unit of A22E except models with EMO/EMS indication is red. (The engraved mark is not white.)

## Switch with Integrated Control Box

Appearance	Contact configuration	Model
	SPST-NC	A22E-M-01B *
	SPST-NO/SPST-NC	A22E-M-11B *
	DPST-NC	A22E-M-02B *

\* Models with Korean S-mark certification.

**Subassembled**.....The Operation Unit, Lamp, or Switch can be ordered separately. Use them in combination for models that are not available as assembled Units. These can also be used as inventory for maintenance parts.

Non-lighted

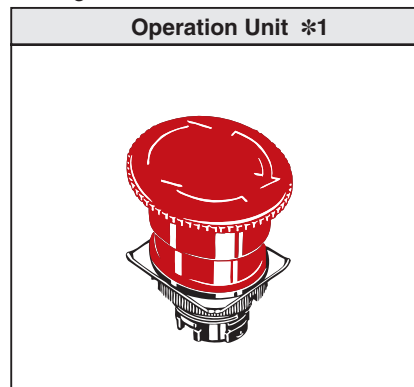

Lighted (without Voltage Reduction Unit)

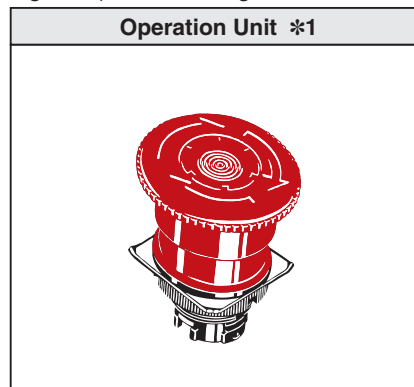

Lighted (with Voltage Reduction Unit)

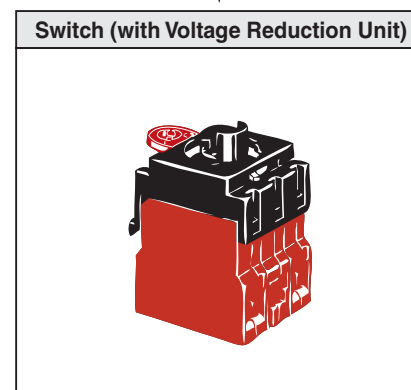
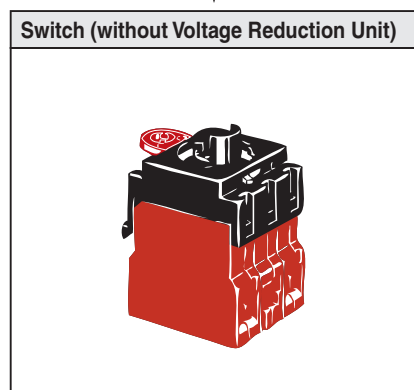
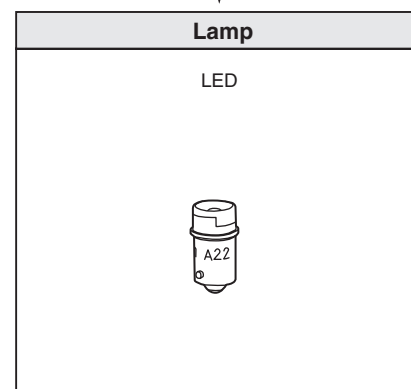
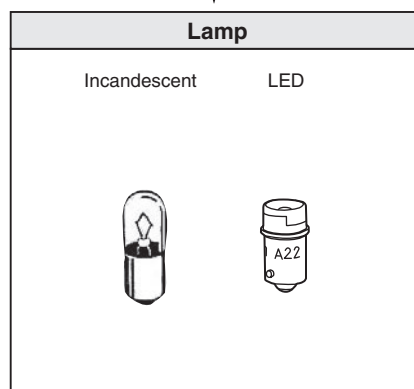
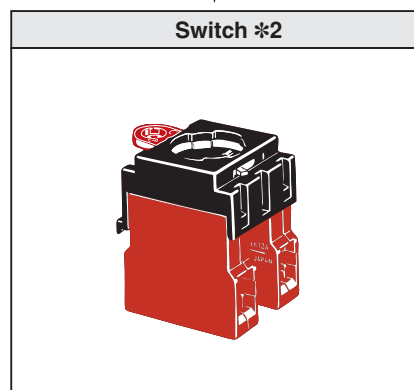
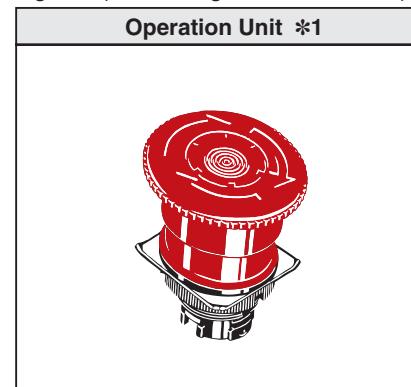





\*1.The Operation Unit of A22E except models with EMO/EMS indication is red. (The engraved mark is not white.)

\*2. Up to three Switch Units can be mounted for multiple contacts.

**Operation Units**

**Non-lighted**

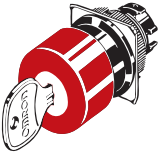
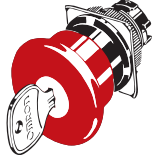
Function	Sealing capability Size	IP65 oil-resistant models		
		Small (30 dia.)	Medium (40 dia.)	Large (60 dia.)
Push-pull		---	<b>A22E-MP</b> 	<b>A22E-LP</b> 
Push-lock, turn-reset	<b>A22E-S</b> 	<b>A22E-M</b> 	<b>A22E-L</b> 	
Push-lock, key-reset (push-lock, turn-reset)	<b>A22E-SK</b> 	<b>A22E-MK</b> 	---	

**Lighted**

Function	Sealing capability Size	IP65
		Medium (40 dia.)
Push-lock, turn-reset		<b>A22EL-M</b> 

**Note:** The Operation Unit of A22E except models with EMO/EMS indication is red. (The engraved mark is not white.)

## Lamp LED

Appearance	LED light		Rated voltage	Model
	Red	Standard	6 VAC/VDC	A22-6AR
			12 VAC/VDC	A22-12AR
			24 VAC/VDC	A22-24AR



**Note:** For voltage-reduction lighting, use the A22-24AR.

## Incandescent



Appearance	Rated voltage	Model
	6 VDC	A22-5
	14 VAC	A22-12
	28 VAC	A22-24
	130 VAC	A22-H1

## Switch (Standard Load)

### Without Voltage Reduction Unit

















Classification Appearance		Non-lighted	Lighted
			
Switch Action		Momentary	Momentary
Contacts		Model	Model
For standard loads	SPST-NC	A22-01M	A22L-01M
	SPST-NO + SPST-NC	A22-11M	A22L-11M
	DPST-NC	A22-02M	A22L-02M





### With Voltage Reduction Unit

Classification Appearance		Lighted (110 VAC)	Lighted (220 VAC)
			
Switch Action		Momentary	Momentary
Contacts		Model	Model
For standard loads	SPST-NC	A22L-01M-T1	A22L-01M-T2
	SPST-NO + SPST-NC	A22L-11M-T1	A22L-11M-T2
	DPST-NC	A22L-02M-T1	A22L-02M-T2

**Note:** When using with a Voltage Reduction Unit, use the A22-24AR.

## Accessories (Order Separately)

Item	Appearance	Classification		Model	Remarks
Switch Blocks		SPST-NO	Standard load	<b>A22-10</b>	Provided as standard. Order Switch Blocks only when adding or replacing them.
			Microload	<b>A22-10S</b>	
		SPST-NC	Standard load	<b>A22-01</b>	
			Microload	<b>A22-01S</b>	
		DPST-NO, one-piece	Standard load	<b>A22-20</b>	
			Microload	<b>A22-20S</b>	
DPST-NC, one-piece	Standard load	<b>A22-02</b>			
	Microload	<b>A22-02S</b>			
Lamp Sockets		Direct lighting		<b>A22-TN</b>	Used when changing the lighting method.
		Voltage-reduction lighting	100 VAC	<b>A22-T1</b>	
			200 VAC	<b>A22-T2</b>	
Mounting Latches		---		<b>A22-3200</b>	Provided as standard. Order Mounting Latches only when mounting Switch Blocks or Lamp Sockets that are purchased individually.
Legend Plates for Emergency Stop		60-dia. black letters on yellow back-ground		<b>A22Z-3466-1</b>	"EMERGENCY STOP" is indicated on the plate. *2
		90-dia. black letters on yellow back-ground		<b>A22Z-3476-1</b>	
		60-dia. black letters on yellow back-ground		<b>A22Z-3466-2</b>	"EMERGENCY OFF" is indicated on the plate.
Hole Plug		Round		<b>A22Z-3530</b>	Can be plugged into pre-cut panel holes for future expansion. The color is black.
Connectors		Applicable cable diameter	7 to 9 dia.	<b>A22Z-3500-1</b>	Plastic connector used to extend a cable from the Switch Box.
			9 to 11 dia.	<b>A22Z-3500-2</b>	
25-dia. Ring		---		<b>A22Z-R25</b>	Can be fit into a 25-dia. hole in the panel. Since this is not attached to the main body, order separately. (Refer to page 14.)
30-dia. Resin Attachment		---		<b>A22Z-A30</b>	Can be fit into a 30-dia. hole in the panel. (Refer to page 14.)
Lock Plate		---		<b>A22Z-3380</b>	Use to fix the lever on the Switch.
Control Boxes (Enclosures)		One hole, yellow box (for emergency stop)		<b>A22Z-B101Y</b>	Material: Polycarbonate resin *2
Operation Keys		---		<b>A22K-K</b>	Two keys are provided.
Lock Ring		Rounded shape		<b>A22Z-3360</b>	The body is equipped with a Lock Fitting. This Lock Fitting is used when a more secure lock feature is required. (Refer to page 14.)
Lamp Extractor		---		<b>A22Z-3901</b>	Rubber tool used to replace Lamps easily
Tightening Tool		---		<b>A22Z-3905</b>	Tool used to tighten rings from the back of the panel and to attach caps to lighted models.

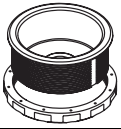
Item	Appearance	Classification	Model	Remarks
E-stop Shroud for EMO, Yellow		---	A22Z-EG1	Provides SEMI-S2/SEMATECH Application Guide for SEMI-S2 compatibility. The SEMI-S2-compatible Shroud and legend plate for EMERGENCY OFF come as a set. Use with an A22E Emergency Stop Switch. (for emergency shutoff) *1 *2
E-stop Shroud for EMO, Yellow		Legend plate for EMERGENCY OFF is not included.	A22Z-EG10	Provides SEMI-S2/SEMATECH APPLICATION GUIDE FOR SEMI S2 compatibility. Use with an A22E with EMO indication. (for emergency off) *2
E-stop Shroud for EMS, White		---	A22Z-EG1-W	Provides SEMI-S2/SEMATECH Application Guide for SEMI-S2 compatibility. The SEMI-S2-compatible Shroud and legend plate for EMERGENCY STOP come as a set. Use with an A22E Emergency Stop Switch. (for emergency stop) *1*2
E-stop Shroud for EMS, White		Legend plate for EMERGENCY STOP is not included.	A22Z-EG10-W	Provides SEMI-S2/SEMATECH APPLICATION GUIDE FOR SEMI S2 compatibility. Use with an A22E with EMS indication. (for emergency stop) *2
E-stop Shroud, Yellow		---	A22Z-EG2	SEMI-S2/SEMATECH Application Guide for SEMI S2-compatible Shroud. (for emergency shutoff) *1*2 Use together with an A22E Emergency Stop Switch.

\*1. These Shrouds are for use with the equipment only that conforms to SEMI standards. Do not use them for any other applications (e.g. emergency stop switches for machines or devices such as Machine tools, Printing presses, Industrial machinery, etc).

\*2. The A22-B101Y cannot be used in combination with the A22Z-3476-1 and the A22Z-EG□.

**Note:** 1. Accessories for A22Z-EG1: one "EMERGENCY OFF" label, two rubber washers, and one lock ring  
2. Accessories for A22Z-EG10: one rubber washer and one lock ring (without label)

## Specifications

### Certified Standard Ratings

- UL, cUL (File No. E41515)  
6A at 220 VAC, 10 A at 110 VAC
- TÜV (EN60947-5-1) (Low Voltage Directive)  
3 A at 220 VAC
- CCC (GB14048.5)  
3 A at 240 VAC, 1.5 A at 24 VDC

### Certified Standards

Certification body	Standards	File No.
UL *1	UL508, C22.2 No.14	E41515
TÜV SÜD	EN60947-5-1, EN60947-5-5 (certified direct opening mechanism)	Inquire
CQC (CCC)	GB14048.5	2003010303070635
KOSHA *2	EN60947-5-1	2004-220, 2007-27 2009-189 (A22E-□-□-EMS/EMO)

**Note:** Only models with NC contacts have a direct opening mechanism.

\*1. UL-certification for CSA C22.2 No. 14 and bears the  mark.

Certification has been obtained for the Switch Unit and the Lamp Socket.

\*2. Some models have been certified.

## Ratings

### Contacts (Standard Load)

Rated carry current (A)	Rated voltage (V)	Rated current (A)			
		AC15 (inductive load)	AC12 (resistive load)	DC13 (inductive load)	DC12 (resistive load)
10	24 VAC	10	10	---	---
	110 VAC	5	10		
	220 VAC	3	6		
	380 VAC	2	3		
	440 VAC	1	2		
	24 VDC	---	---	1.5	10
	110 VDC			0.5	2
	220 VDC			0.2	0.6
	380 VDC			0.1	0.2

**Note:** 1. Rated current values are determined according to the testing conditions. The above ratings were obtained by conducting tests under the following conditions.

- (1) Ambient temperature: 20±2°C
- (2) Ambient humidity: 65±5%
- (3) Operating frequency: 20 operations/minute

2. Minimum applicable load: 10 mA at 5 VDC

### LED Indicators without Voltage Reduction Unit

Rated voltage	Rated current	Operating voltage
6 VAC/VDC	8 mA	6 VAC/VDC±5%
12 VAC/VDC		12 VAC/VDC±5%
24 VAC/VDC		24 VAC/VDC±5%



## Characteristics

Item	Type	Emergency Stop Switches	
		Non-lighted model: A22E	Lighted model: A22EL
Allowable operating frequency	Mechanical	30 operations/minute *3	
	Electrical	30 operations/minute *3	
Insulation resistance		100 MΩ min. (at 500 VDC)	
Dielectric strength	Between terminals of same polarity	2,500 VAC, 50/60 Hz for 1 min	
	Between each terminal and ground	2,500 VAC, 50/60 Hz for 1 min	
Vibration resistance *2		10 to 55 Hz, 1.5-mm double amplitude (within 1 ms)	
Shock resistance	Destruction	1,000 m/s <sup>2</sup>	
	Malfunction *2	250 m/s <sup>2</sup> max.	
Durability	Mechanical	300,000 operations min. *3	
	Electrical	300,000 operations min. *3	
Ambient operating temperature *1		-20 to 70°C	-20 to 55°C
Ambient operating humidity		35% to 85%	
Ambient storage temperature		-40 to 70°C	
Degree of protection		IP65 (oil-resistant) *4	IP65 *4
Electric shock protection class		Class II	
PTI (tracking characteristic)		175	
Degree of contamination		3 (EN60947-5-1)	

\*1. With no icing or condensation.

\*2. Malfunction within 1 ms.

\*3. Setting and resetting once is counted as one operation.

\*4. The degree of protection from the front of the panel.

## Structure and Nomenclature

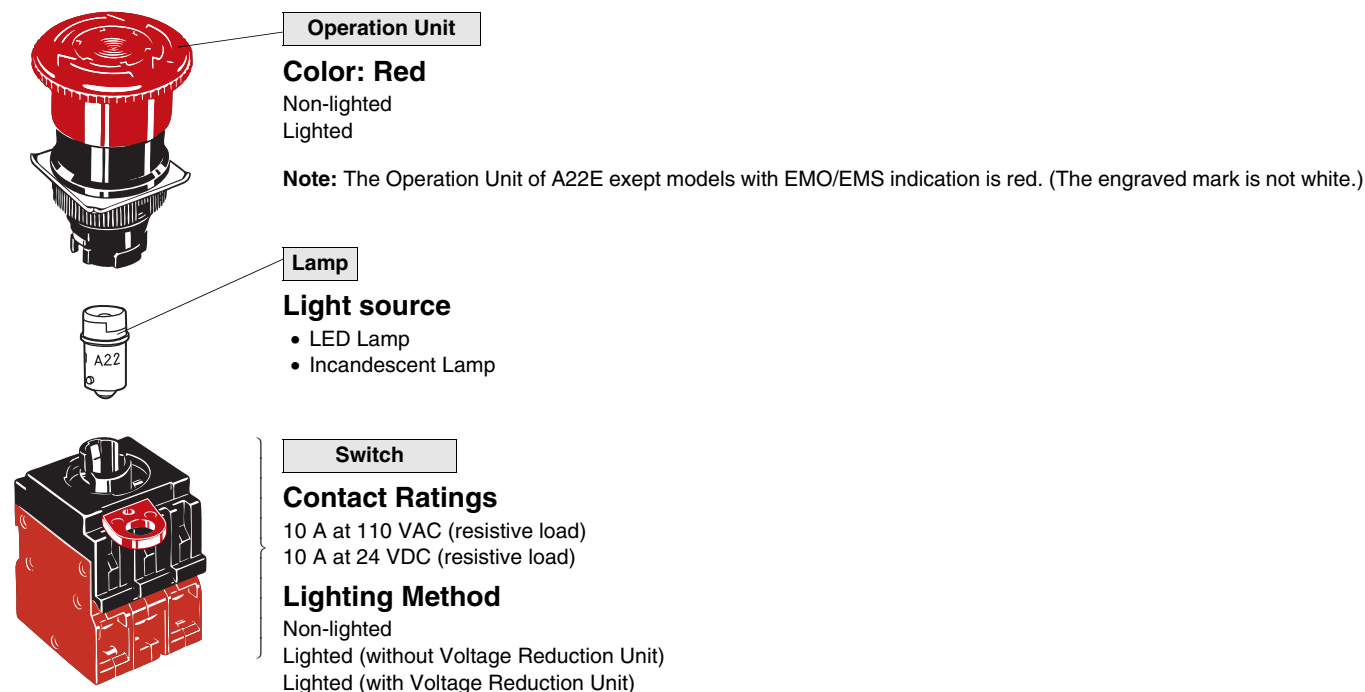

(The above figures are examples of the lighted model.)

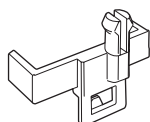

### Lock Plate (Attached with the Operation Unit)

(Refer to the Mounting the Lock Plate on page 16 for use.)

# Dimensions

## Non-lighted Models

**A22E-MP**  
Medium Push-pull (40-dia.)

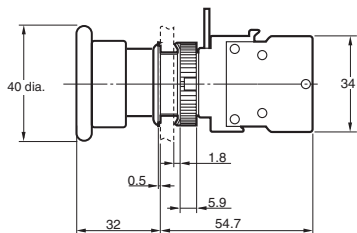
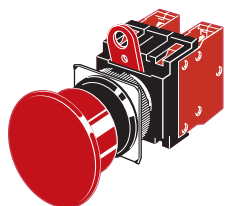

**A22E-LP**  
Large Push-pull (60-dia.)

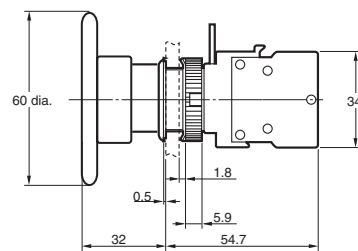
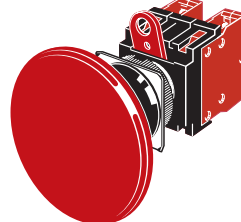

**A22E-S**  
Small Push-lock, Turn-reset (30-dia.)

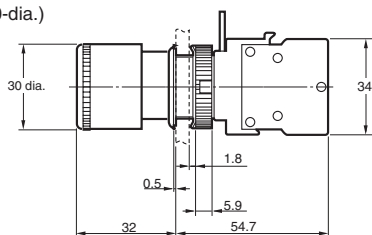

**A22E-M**  
Medium Push-lock, Turn-reset (40-dia.)

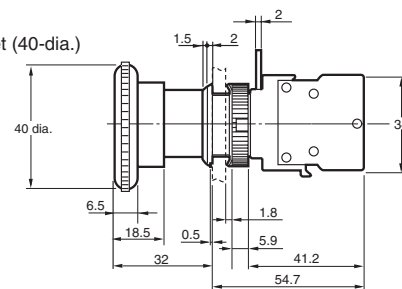
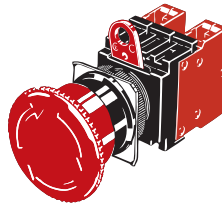

**Note:** The dimensions are the same as for EMO/EMS indication models.

**A22E-L**  
Large Push-lock, Turn-reset (60-dia.)

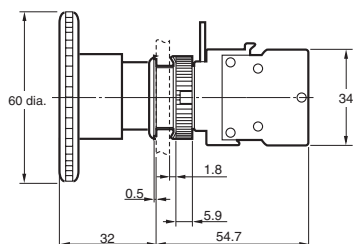
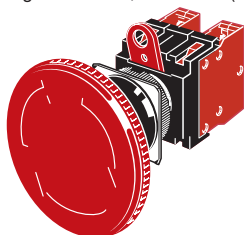

**A22E-SK**  
Small Push-lock, Key-reset (30-dia.)

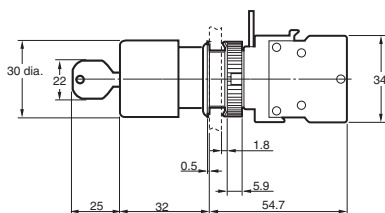
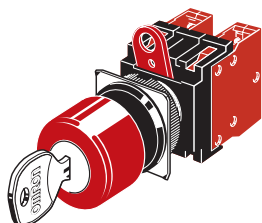

**A22E-MK**  
Medium Push-lock, Key-reset (40-dia.)

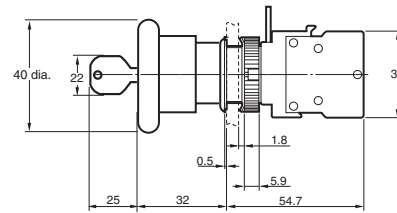
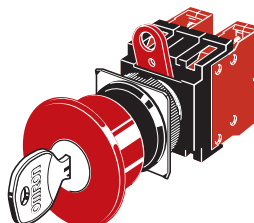

## Lighted Models

**A22EL-M**  
Medium Push-lock, Turn-reset (40-dia.)

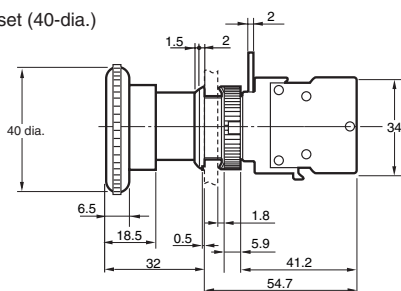
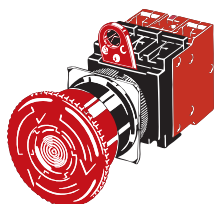

## Switch dimensions when mounted to a DPST-NO (or DPST-NC) one-piece Switch Block

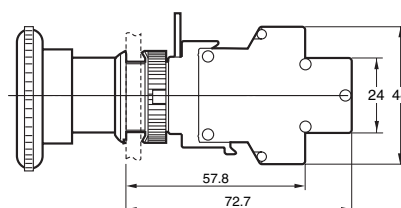

**Note:** The operation unit is an example for the A22E-M.

**Note:** The Operation Unit of A22E except models with EMO/EMS indication is red. (The engraved mark is not white.)

### Dimensions for Accessories

**Hole Plug**  
Round A22Z-3530

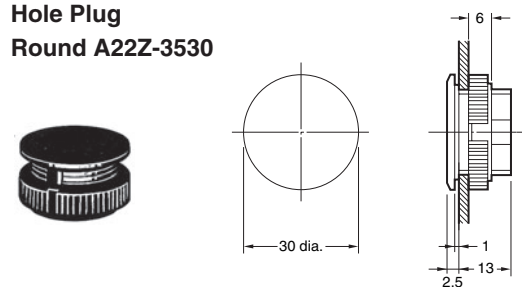

**30-dia. Resin Attachment**  
A22Z-A30

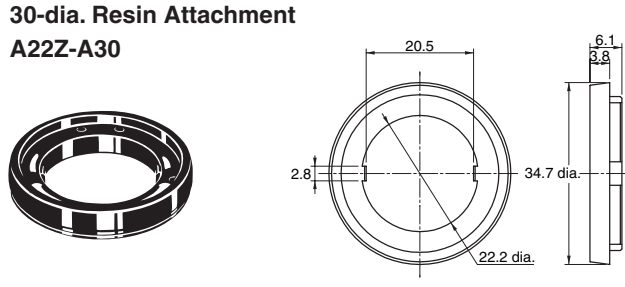

**Lamp Extractor**  
A22Z-3901

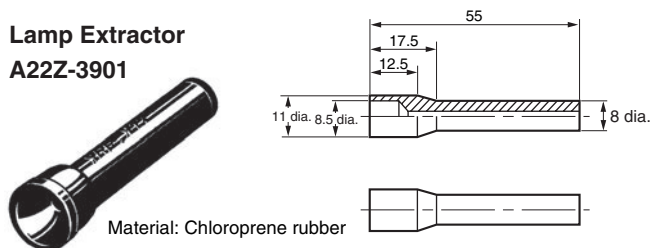

**Tightening Tool**  
A22Z-3905

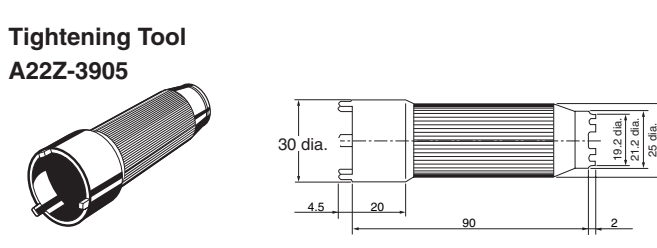

### Legend Plates for Emergency Stop

A22Z-3476-1 (90 dia.)

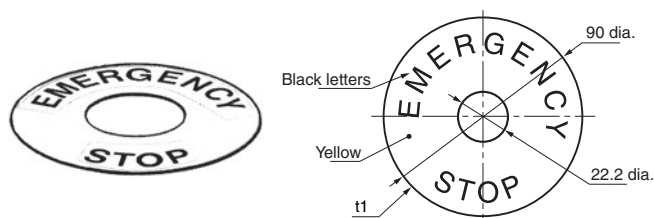

A22Z-3466-1 (60 dia.)

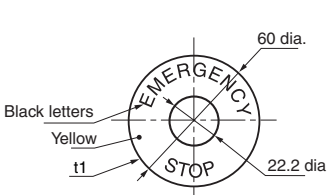

A22Z-3466-2 (60 dia.)

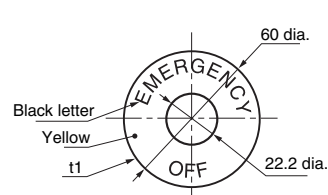

**Lock Ring**  
A22Z-3360

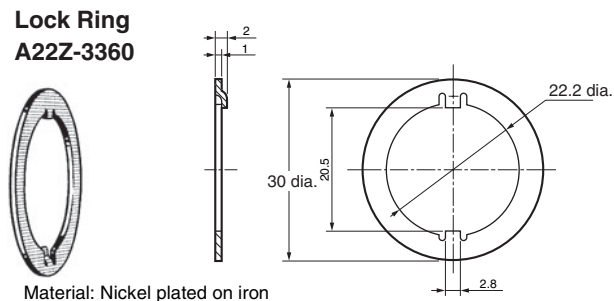

Material: Nickel plated on iron

**25-dia. Ring**  
A22Z-R25

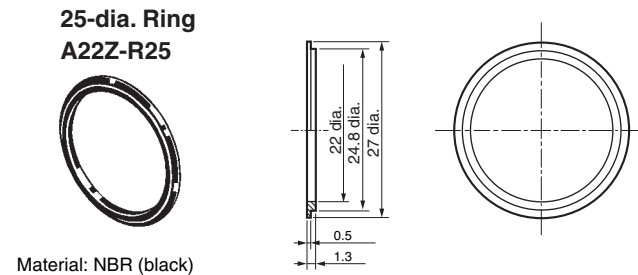

Material: NBR (black)

### Lamp

**LED A22-6□, 12□, 24□**

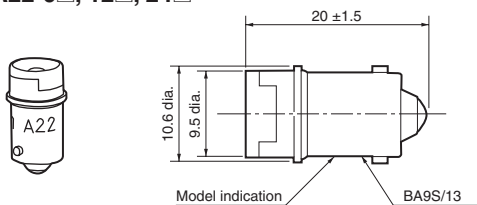

**Incandescent Lamp A22-5, 12, 24, H1**

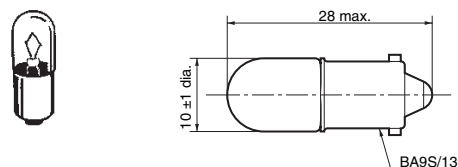

### Control Box

A22Z-B101Y (1 hole)

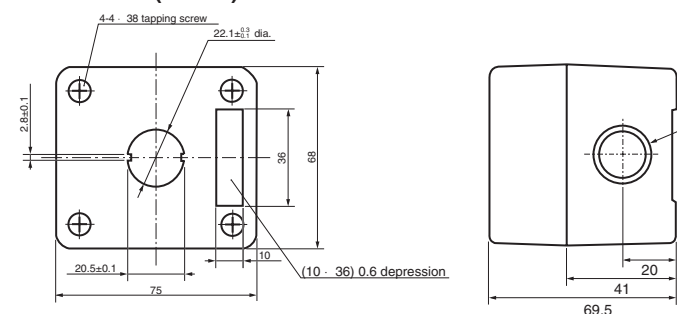

**Cable Draw-out Hole (Top View)**

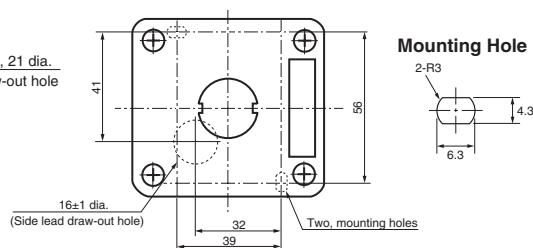

**E-stop Shroud**

**A22Z-EG1, A22Z-EG1-W, A22Z-EG10, A22Z-EG10-W**

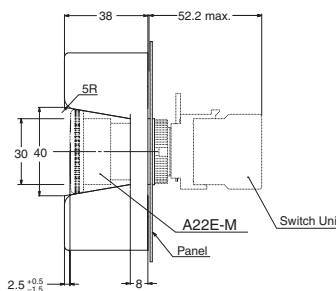
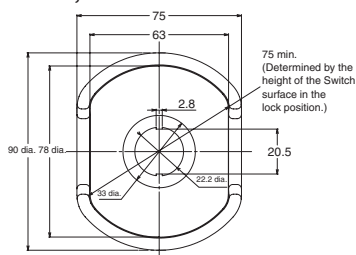

Panel Cutout Dimensions

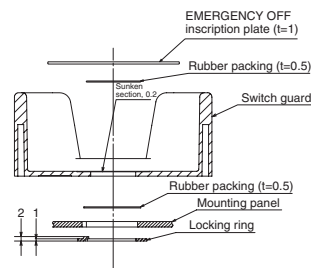
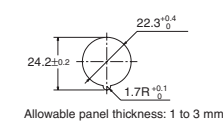

- Note:**
1. The dimensions of the Shroud conform to the specifications of the SEMATECH Application Guide for SEMI S2-93.
  2. The Shroud is not provided with the Switch.



"EMERGENCY STOP" is indicated on A22Z-EG1-W. Legend plate is not provided with A22Z-EG10 and A22Z-EG10-W.

**E-stop Shroud**

**A22Z-EG2, A22Z-EG21, A22Z-EG22**

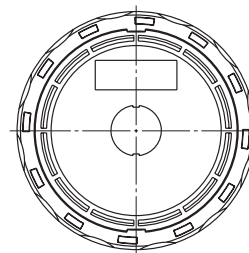
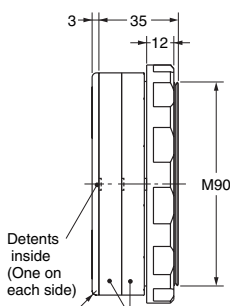
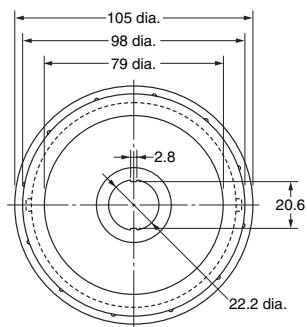
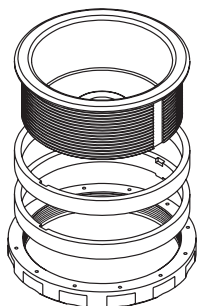

The number of spacers depends on the model  
 A22Z-EG2 : No Spacer  
 A22Z-EG21 : 1 Spacer  
 A22Z-EG22 : 2 Spacers

**Mounting with Spacers**

With 1 Spacer      With 2 Spacers

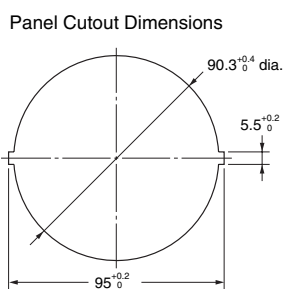
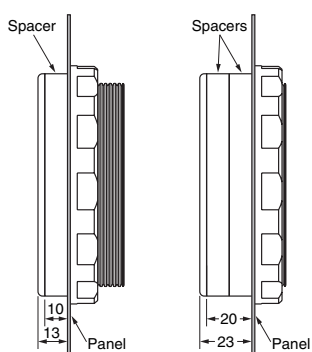

**Mounting a 1-pole Switch Unit \***

**Mounting a 2-pole Switch Unit \***

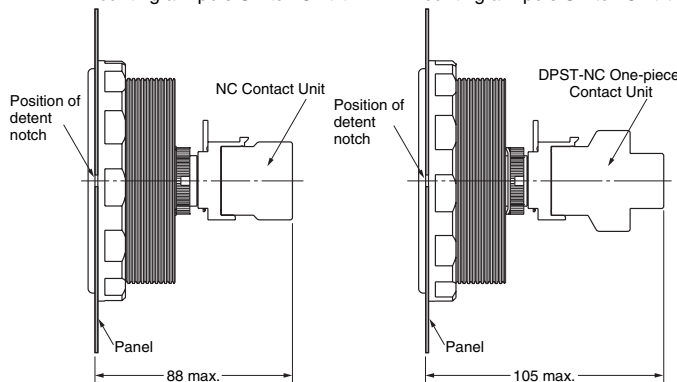

- Note:**
1. The dimensions of the Shroud conform to the specifications of the SEMATECH Application Guide for SEMI S2-93.
  2. The Shroud is not provided with the Switch.

3. Tighten to a torque of 1.96 to 2.94 N·m.
4. The allowable panel thicknesses are as follows:  
 Without Spacers: t=1.3 to 22.5 mm  
 With 1 Spacer: t=1.3 to 12.5 mm  
 With 2 Spacers: t=1.3 to 2.5 mm

\* These are the dimension from the front of the panel when the Switch Unit is attached.

## Panel Cutouts

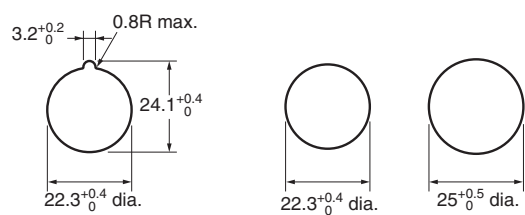

With Lock Fitting

Without Lock Fitting

**A Lock Ring is provided as a standard feature.**

- When painting or coating the panel, make sure that the specified panel dimensions apply to the panel after painting or coating.
- Use an A22Z-R25 Ring when mounting to a panel with a 25-mm diameter hole.

## Terminal Arrangement (Bottom View)

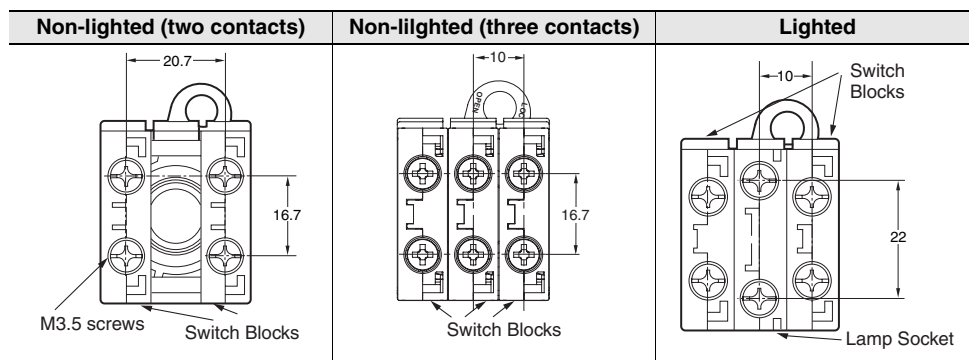

## Terminal Connection

Type	Terminal connection (BOTTOM VIEW)			
	SPST-NO + SPST-NC	DPST-NC	DPST-NC + SPST-NO	TPST-NC
Non-lighted				
Lighted without Voltage Reduction Unit				
Lighted with Voltage Reduction Unit				

**Note:** The above terminal connection diagrams are examples for SPST-NO + SPST-NC and DPST-NC.

# Installation

## Mounting to the Panel

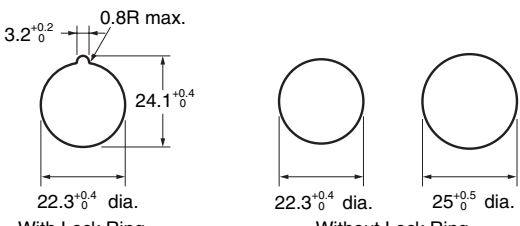
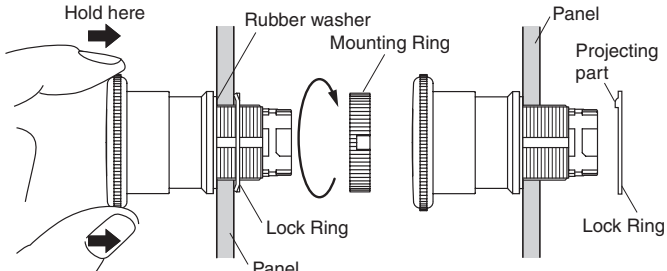
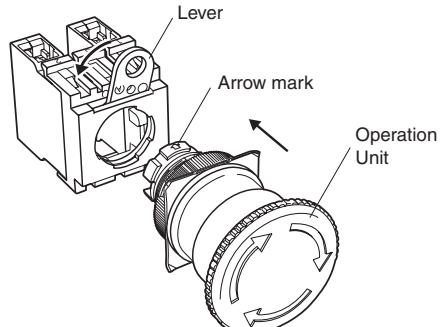
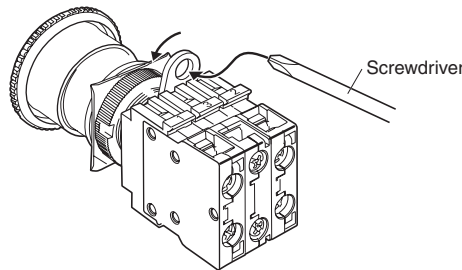
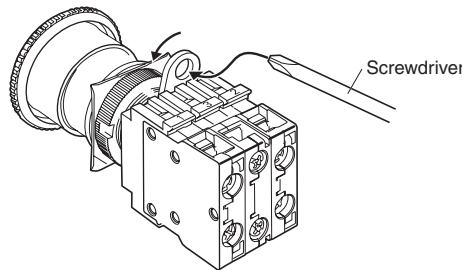
(1) Preparing the Panel	(2) Mounting the Operation Unit on the Panel
<ul style="list-style-type: none"> <li>The panel dimensions are shown below.</li> <li>The panel thickness must be 1 to 5 mm.</li> </ul>  <ul style="list-style-type: none"> <li>Always use a 25-mm-dia. Lock Ring for a 25-mm-dia. hole. IP65 degree of protection will be lost if the 25-mm-dia. Lock Ring is not used because of the larger size of a 25-mm-dia. hole.</li> <li>When painting or coating the panel, make sure that the specified panel dimensions apply to the panel after painting or coating.</li> </ul>	<ul style="list-style-type: none"> <li>Insert the Operation Unit from the front surface of the panel, insert the Lock Ring and the mounting Ring from the terminal side, then tighten the Ring. Before tightening, check that the rubber washer is present between the Operation Unit and the panel.</li> <li>Align the Lock Ring with the groove in the casing, then insert the Lock Ring so that its edge is located on the panel side.</li> <li>Tighten the mounting nut at a torque of 0.98 to 1.96 N·m.</li> <li>When using a Lock Ring, replace with the supplied Lock Ring, insert the projecting part into the lock slot, and then tighten the mounting Ring.</li> </ul> 
<p><b>(3) Mounting the Switch on the Operation Unit</b></p>	
<ul style="list-style-type: none"> <li>Insert the Operation Unit into the Switch Unit, aligning the arrow mark inscribed on the Case with the lever on the Switch Blocks, then move the lever in the direction indicated by the arrow in the following figure.</li> </ul> 	<ol style="list-style-type: none"> <li>When the panel cutout dimension is 25 dia., remove the supplied rubber washer and mount the 25-dia. Ring as shown below. (Since the A22Z-R25 is not attached to the main body, order separately.) When using a Legend Plate (sold separately), do not remove the rubber washer.</li> <li>When the panel cutout dimension is 30 dia., use resin attachment A22Z-A30. Since it is not attached to the main body, order separately.</li> </ol> 
<p><b>(4) Removing the Switch</b></p>	
<ul style="list-style-type: none"> <li>Move the lever in the direction indicated by the arrow in the following figure, then pull the Operation Unit or the Switch Blocks. Since the lever has a hole with an inside diameter of 6.5 mm, the lever can be moved in the specified direction by inserting a screwdriver into the hole and then moving the screwdriver.</li> </ul> 	

## Assembling the Cap

**Emergency Stop Switch**

- Insert the protrusion of the Tightening Wrench (A22Z-3905) into the Cap slot and then turn to remove the Cap.

## Installing/Replacing the Lamp



(1) Installing/Replacing from the Panel Surface	(2) Installing/Replacing on the Switch
<ul style="list-style-type: none"> <li>Insert the Lamp Extractor (A22Z-3901) into the lamp, then rotate the Extractor while pressing it.</li> </ul>	<ul style="list-style-type: none"> <li>Grip the indicator with your fingers, then rotate the indicator while pressing it against the Switch.</li> </ul>

## Control Box (Enclosure)

(1) Mounting the Switch	(2) Creating a Cable Port Hole	(3) Securing the Connector Cable						
<p>The Standard-size Legend Plate Frame can be mounted. Mount the Frame as shown in the following diagram. Mount the Switch in the same way as for an ordinary panel.</p>	<p>Place the tip of a screwdriver on the surface where the cable port hole is to be created with the cover attached and strike the screwdriver to punch a hole. Attempts to punch a hole on the other side of the case will damage the Box.</p>	<ol style="list-style-type: none"> <li>Insert the connector into the cable port hole in the Box and secure with the Mounting Ring inside the box.</li> <li>Pass the tightening cap through the cable, insert the cable into the connector, and tighten the tightening cap to secure the cable.</li> </ol> <table border="1" style="margin-left: auto; margin-right: auto; border-collapse: collapse;"> <thead> <tr> <th style="text-align: center;">Cable diameter</th> <th style="text-align: center;">Connector</th> </tr> </thead> <tbody> <tr> <td style="text-align: center;">7 to 9 dia.</td> <td style="text-align: center;">A22Z-3500-1</td> </tr> <tr> <td style="text-align: center;">9 to 11 dia.</td> <td style="text-align: center;">A22Z-3500-2</td> </tr> </tbody> </table>	Cable diameter	Connector	7 to 9 dia.	A22Z-3500-1	9 to 11 dia.	A22Z-3500-2
Cable diameter	Connector							
7 to 9 dia.	A22Z-3500-1							
9 to 11 dia.	A22Z-3500-2							

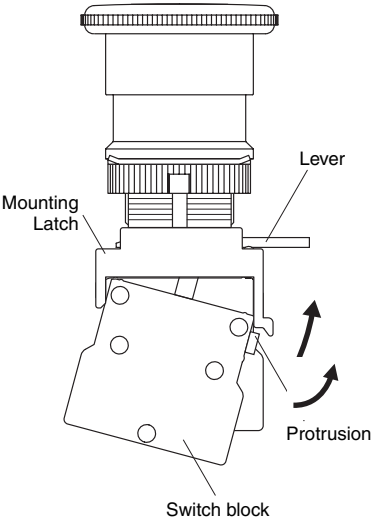
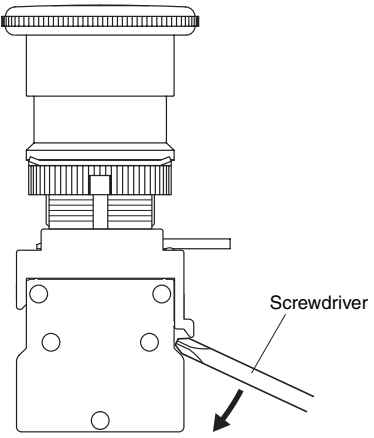

## Installing/Removing the Switch Blocks

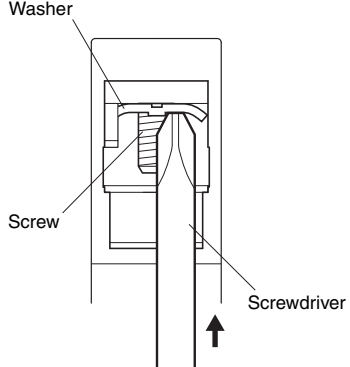
(1) Installing the Switch Blocks	(2) Removing the Switch Blocks	Wiring
<ul style="list-style-type: none"> <li>Hook the small protrusion on the Mounting Latch into the groove on the other side of the lever, then push up the Switch Block in the direction indicated by the arrow in the figure below.</li> </ul> 	<ul style="list-style-type: none"> <li>Insert a screwdriver between the Mounting Latch and the Switch Block, then push down the screwdriver in the direction indicated by the arrow in the following figure.</li> </ul>  <p>Use either of the following screwdrivers.</p> <ul style="list-style-type: none"> <li>⊖ Flat-head screwdriver 3 to 6 mm</li> <li>⊕ Phillips screwdriver 3 to 6 mm dia.</li> </ul> 	<ul style="list-style-type: none"> <li>Loosen the terminal screw from the Switch Unit until it completely comes off the groove, insert a screwdriver as shown in the following figure, then push up the washer in the direction indicated by the arrow to temporarily secure it. Now, a round crimp terminal can be connected. After inserting the terminal, tighten the screws to complete wiring.</li> </ul> 

## Safety Precautions

Be sure to read the precautions for all pushbutton switches in the *Pushbutton Switches Group Catalog* (Cat. No. X032).

### CAUTION

Do not apply a voltage exceeding the rated voltage across the incandescent lamp terminals. The lamp may be destroyed and the operation unit may fly out.



If the Operation Unit is separated from the Socket Unit, the equipment will not stop, creating a hazardous condition. Secure the lever on the Socket Unit by using the A22Z-3380 Lock Plate so that the Operation Unit cannot be easily separated from the Socket Unit. (Refer to "Mounting the Lock Plate" at the right.)



### Precautions for Correct Use

#### Mounting

- Always make sure that the power is turned OFF before wiring the Switch. Also, do not touch the terminals or other current-carrying parts while power is being supplied. Electric shock may occur.
- Do not tighten the mounting ring more than necessary using tools such as pointed-nose pliers. Doing so will damage the mounting ring. The tightening torque is 0.98 to 1.96 N·m.
- Recommended panel thickness: 1 to 5 mm.
- When mounting the caps after changing the LED or the caps, tighten the caps at a tightening torque of 0.49 to 0.78 N·m.

#### Mounting the Lock Plate

- Confirm that the lever on the Mounting Latch is on the side where the Operation Unit is secured and then insert the protrusion on the Lock Plate into the hole in the lever on the Mounting Latch.
- Press the hole on the Lock Plate onto the protrusion on the Mounting Latch until it clicks into place.

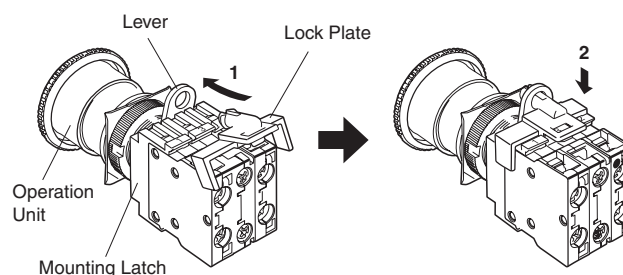



## Wiring

- Terminal screws must be Phillips or slotted M3.5 screws with a square washer.
- The tightening torque is 1.08 to 1.27 N·m.
- Single wires, stranded wires, and crimp terminals can be connected to the Switch.
- Applicable Wiring Materials:  
Twisted strands: 2 mm<sup>2</sup> max.  
Solid wire: 1.6 mm dia. max.

### Naked Crimp Terminals

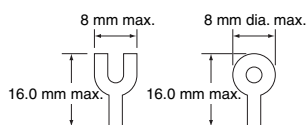

### Crimp Terminals with Insulating Sheaths

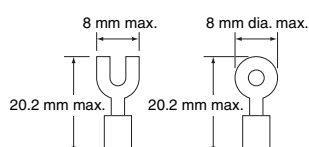

- After wiring the Switch, maintain an appropriate clearance and creepage distance.

## Operating Environment

- The IP65 model is designed with a protective structure so that it will not sustain damage if it is subjected to water from any direction to the front of the panel.
- The Switch is intended for indoor use only. Using the Switch outdoor may cause it to fail.

## LEDs

- The LED current-limiting resistor is built-in, so internal resistance is not required.
- If commercially available LEDs are used, select the ones that meet the following conditions:  
Base: BA9S/13  
Overall length: 26 mm max.  
Power consumption: 2.6 W max.  
When DC-specific LEDs are used, wire the Switch so that the X1 terminal is positive.
- Mis-lighting of the LED  
The LED lights with approx. 0.1 mA or less of micro-current. Take a countermeasure like adding a resistor to prevent mis-lighting in parallel to the LED.  
The micro-current varies with the machine (leak current or stray capacity between cables, etc.). Select resistance value and allowable power consumption that meet the actual current.

### (Circuit example)

In case of using 24 VAC/VDC, Direct lighting

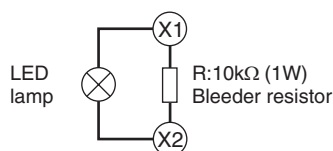

## Using the Microload

Contact failure may occur if a Switch designed for a standard load is used to switch a microload. Use Switches within the application ranges shown in the following graph. Even within the application range, insert a contact protection circuit, if necessary, to prevent the reduction of life expectancy due to extreme wear on the contacts caused by loads where inrush current occurs when the contact is opened and closed.

The minimum applicable load is the N-level reference value. This value indicates the malfunction reference level for the reliability level of 60% ( $\lambda_{60}$ ) (conforming to JIS C5003).

The equation,  $\lambda_{60} = 0.5 \times 10^{-6}/\text{time}$  indicates that the estimated malfunction rate is less than 1/2,000,000 with a reliability level of 60%.

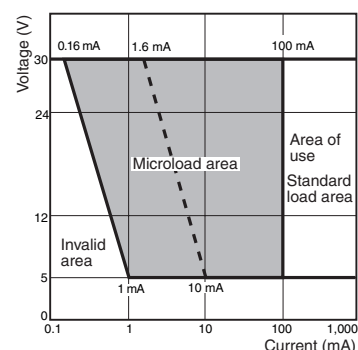

## Others

- If the panel is to be coated, make sure that the panel meets the specified dimensions after coating.
- Due to the structure of the Switch, severe shock or vibration may cause malfunctions or damage to the Switch.  
Also, most Switches are made from resin and will be damaged if they come into contact with sharp objects. Particularly scratches on the Operation Unit may create visual and operational obtrusions.  
Handle the Switches with care, and do not throw or drop them.

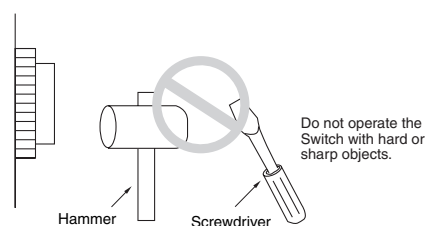
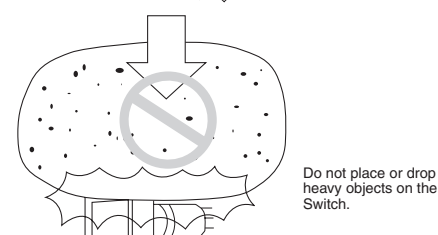
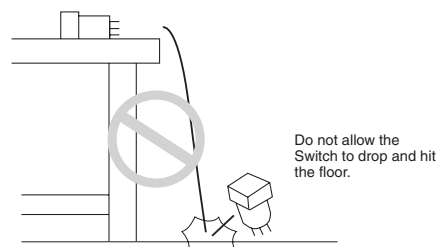

## Read and Understand This Catalog

Please read and understand this catalog before purchasing the products. Please consult your OMRON representative if you have any questions or comments.

## Warranty and Limitations of Liability

### WARRANTY

OMRON's exclusive warranty is that the products are free from defects in materials and workmanship for a period of one year (or other period if specified) from date of sale by OMRON.

OMRON MAKES NO WARRANTY OR REPRESENTATION, EXPRESS OR IMPLIED, REGARDING NON-INFRINGEMENT, MERCHANTABILITY, OR FITNESS FOR PARTICULAR PURPOSE OF THE PRODUCTS. ANY BUYER OR USER ACKNOWLEDGES THAT THE BUYER OR USER ALONE HAS DETERMINED THAT THE PRODUCTS WILL SUITABLY MEET THE REQUIREMENTS OF THEIR INTENDED USE. OMRON DISCLAIMS ALL OTHER WARRANTIES, EXPRESS OR IMPLIED.

### LIMITATIONS OF LIABILITY

OMRON SHALL NOT BE RESPONSIBLE FOR SPECIAL, INDIRECT, OR CONSEQUENTIAL DAMAGES, LOSS OF PROFITS OR COMMERCIAL LOSS IN ANY WAY CONNECTED WITH THE PRODUCTS, WHETHER SUCH CLAIM IS BASED ON CONTRACT, WARRANTY, NEGLIGENCE, OR STRICT LIABILITY.

In no event shall the responsibility of OMRON for any act exceed the individual price of the product on which liability is asserted.

IN NO EVENT SHALL OMRON BE RESPONSIBLE FOR WARRANTY, REPAIR, OR OTHER CLAIMS REGARDING THE PRODUCTS UNLESS OMRON'S ANALYSIS CONFIRMS THAT THE PRODUCTS WERE PROPERLY HANDLED, STORED, INSTALLED, AND MAINTAINED AND NOT SUBJECT TO CONTAMINATION, ABUSE, MISUSE, OR INAPPROPRIATE MODIFICATION OR REPAIR.

## Application Considerations

### SUITABILITY FOR USE

OMRON shall not be responsible for conformity with any standards, codes, or regulations that apply to the combination of products in the customer's application or use of the products.

At the customer's request, OMRON will provide applicable third party certification documents identifying ratings and limitations of use that apply to the products. This information by itself is not sufficient for a complete determination of the suitability of the products in combination with the end product, machine, system, or other application or use.

The following are some examples of applications for which particular attention must be given. This is not intended to be an exhaustive list of all possible uses of the products, nor is it intended to imply that the uses listed may be suitable for the products:

- Outdoor use, uses involving potential chemical contamination or electrical interference, or conditions or uses not described in this catalog.
- Nuclear energy control systems, combustion systems, railroad systems, aviation systems, medical equipment, amusement machines, vehicles, safety equipment, and installations subject to separate industry or government regulations.
- Systems, machines, and equipment that could present a risk to life or property.

Please know and observe all prohibitions of use applicable to the products.

NEVER USE THE PRODUCTS FOR AN APPLICATION INVOLVING SERIOUS RISK TO LIFE OR PROPERTY WITHOUT ENSURING THAT THE SYSTEM AS A WHOLE HAS BEEN DESIGNED TO ADDRESS THE RISKS, AND THAT THE OMRON PRODUCTS ARE PROPERLY RATED AND INSTALLED FOR THE INTENDED USE WITHIN THE OVERALL EQUIPMENT OR SYSTEM.

### PROGRAMMABLE PRODUCTS

OMRON shall not be responsible for the user's programming of a programmable product, or any consequence thereof.

## Disclaimers

### CHANGE IN SPECIFICATIONS

Product specifications and accessories may be changed at any time based on improvements and other reasons.

It is our practice to change model numbers when published ratings or features are changed, or when significant construction changes are made. However, some specifications of the products may be changed without any notice. When in doubt, special model numbers may be assigned to fix or establish key specifications for your application on your request. Please consult with your OMRON representative at any time to confirm actual specifications of purchased products.

### DIMENSIONS AND WEIGHTS

Dimensions and weights are nominal and are not to be used for manufacturing purposes, even when tolerances are shown.

### PERFORMANCE DATA

Performance data given in this catalog is provided as a guide for the user in determining suitability and does not constitute a warranty. It may represent the result of OMRON's test conditions, and the users must correlate it to actual application requirements. Actual performance is subject to the OMRON Warranty and Limitations of Liability.

### ERRORS AND OMISSIONS

The information in this document has been carefully checked and is believed to be accurate; however, no responsibility is assumed for clerical, typographical, or proofreading errors, or omissions.

2011.12

In the interest of product improvement, specifications are subject to change without notice.

**OMRON Corporation**  
Industrial Automation Company

<http://www.ia.omron.com/>

(c)Copyright OMRON Corporation 2011 All Right Reserved.



Компания «ЭлектроПласт» предлагает заключение долгосрочных отношений при поставках импортных электронных компонентов на взаимовыгодных условиях!

Наши преимущества:

- Оперативные поставки широкого спектра электронных компонентов отечественного и импортного производства напрямую от производителей и с крупнейших мировых складов;
- Поставка более 17-ти миллионов наименований электронных компонентов;
- Поставка сложных, дефицитных, либо снятых с производства позиций;
- Оперативные сроки поставки под заказ (от 5 рабочих дней);
- Экспресс доставка в любую точку России;
- Техническая поддержка проекта, помощь в подборе аналогов, поставка прототипов;
- Система менеджмента качества сертифицирована по Международному стандарту ISO 9001;
- Лицензия ФСБ на осуществление работ с использованием сведений, составляющих государственную тайну;
- Поставка специализированных компонентов (Xilinx, Altera, Analog Devices, Intersil, Interpoint, Microsemi, Aeroflex, Peregrine, Syfer, Eurofarad, Texas Instrument, Miteq, Cobham, E2V, MA-COM, Hittite, Mini-Circuits, General Dynamics и др.);

Помимо этого, одним из направлений компании «ЭлектроПласт» является направление «Источники питания». Мы предлагаем Вам помощь Конструкторского отдела:

- Подбор оптимального решения, техническое обоснование при выборе компонента;
- Подбор аналогов;
- Консультации по применению компонента;
- Поставка образцов и прототипов;
- Техническая поддержка проекта;
- Защита от снятия компонента с производства.



#### Как с нами связаться

**Телефон:** 8 (812) 309 58 32 (многоканальный)

**Факс:** 8 (812) 320-02-42

**Электронная почта:** [org@eplast1.ru](mailto:org@eplast1.ru)

**Адрес:** 198099, г. Санкт-Петербург, ул. Калинина, дом 2, корпус 4, литера А.