

## FEATURES

Matched pair of programmable filters and VGAs

Continuous gain control range:  $-5$  dB to  $+45$  dB

6-pole filter

1 MHz to 30 MHz in 1 MHz steps, 0.5 dB corner frequency

SPI programmable

6 dB front-end gain step

IMD3:  $>55$  dBc for 1.5 V p-p composite output

HD2, HD3:  $>60$  dBc for 1.5 V p-p output

Differential input and output

Adjustable output common-mode voltage

Optional dc output offset correction

Power-down feature

Single 5 V supply operation

## APPLICATIONS

Baseband I/Q receivers

Diversity receivers

ADC drivers

## GENERAL DESCRIPTION

The [ADRF6510](#) is a matched pair of fully differential low noise and low distortion programmable filters and variable gain amplifiers (VGAs). Each channel is capable of rejecting large out-of-band interferers while reliably boosting the wanted signal, thus reducing the bandwidth and resolution requirements on the analog-to-digital converters (ADCs). The excellent matching between channels and their high spurious-free dynamic range over all gain and bandwidth settings makes the [ADRF6510](#) ideal for quadrature-based (IQ) communication systems with dense constellations, multiple carriers, and nearby interferers.

The filters provide a six-pole Butterworth response with 0.5 dB corner frequencies programmable through the SPI port from 1 MHz to 30 MHz in 1 MHz steps. The preamplifier that precedes the filters offers a pin-programmable option of either 6 dB or 12 dB of gain. The preamplifier sets a differential input impedance of  $400\ \Omega$  and has a common-mode voltage that defaults to 2.1 V but can be driven from 1.5 V to 2.5 V.

## FUNCTIONAL BLOCK DIAGRAM

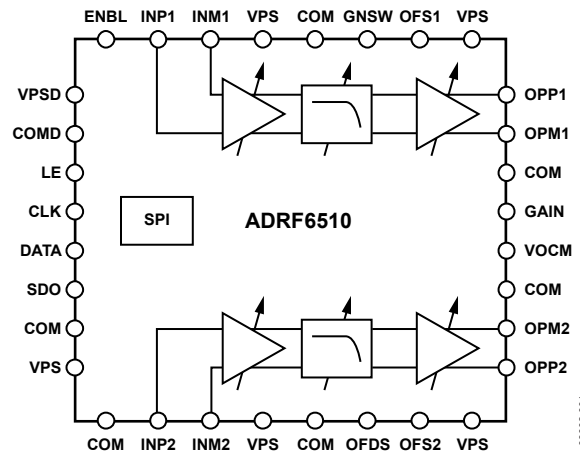

Figure 1.

The variable gain amplifiers that follow the filters provide 50 dB of continuous gain control with a slope of 30 mV/dB. The output buffers provide a differential output impedance of  $20\ \Omega$  that is capable of driving 1.5 V p-p into  $1\ \text{k}\Omega$  loads. The output common-mode voltage defaults to  $VPS/2$ , but it can be programmed via the VOVM pin. The built-in dc offset correction loop can be disabled if dc-coupled operation is desired. The high-pass corner frequency is defined by external capacitors on the OFS1 and OFS2 pins.

The [ADRF6510](#) operates from a 4.75 V to 5.25 V supply and consumes a maximum supply current of 258 mA when programmed to the highest bandwidth setting. When disabled, it consumes 2 mA. The [ADRF6510](#) is fabricated in an advanced silicon-germanium BiCMOS process and is available in a 32-lead, exposed paddle LFCSP. Performance is specified over the  $-40^\circ\text{C}$  to  $+85^\circ\text{C}$  temperature range.

## TABLE OF CONTENTS

Features .....	1	Distortion Characteristics .....	18
Applications .....	1	Maximizing the Dynamic Range .....	18
Functional Block Diagram .....	1	Key Parameters for Quadrature-Based Receivers .....	19
General Description .....	1	Applications Information .....	20
Revision History .....	2	Basic Connections .....	20
Specifications .....	3	Error Vector Magnitude (EVM) Performance .....	20
Timing Diagrams .....	5	EVM .....	21
Absolute Maximum Ratings .....	6	Effect of Filter Bandwidth on EVM .....	21
ESD Caution .....	6	Effect of Output Voltage Levels on EVM .....	21
Pin Configuration and Function Descriptions .....	7	Effect of $C_{OFS}$ on EVM .....	22
Typical Performance Characteristics .....	8	Anti-Aliasing Filter .....	22
Theory of Operation .....	15	Evaluation Board .....	24
Input Buffers .....	15	Evaluation Board Control Software .....	24
Programmable Filters .....	15	Schematics and Artwork .....	24
Variable Gain Amplifiers (VGAs) .....	16	Evaluation Board Configuration Options .....	27
Output Buffers/ADC Drivers .....	16	Outline Dimensions .....	29
DC Offset Compensation Loop .....	16	Ordering Guide .....	29
Programming the Filters .....	17		
Noise Characteristics .....	17		

## REVISION HISTORY

### 9/2017—Rev. A to Rev. B

Changed CP-32-2 to CP-32-7 .....	Throughout
Updated Outline Dimensions .....	29
Changes to Ordering Guide .....	29

### 10/2011—Rev. 0 to Rev. A

Changes to Figure 2 and Figure 3 .....	5
Changes to Table 3 .....	7
Changes to Figure 48, Changes to Error Vector Magnitude (EVM) Performance Section .....	20
Deleted Low IF Image Rejection Section, and Example Baseband Interface Section, Figure 50, and Figure 51; Renumbered Subsequent Figures .....	20
Changes to Figure 49 .....	21

### Added EVM Section, Effect of Filter Bandwidth on EVM

Section, Effect of Output Voltage Levels on EVM Section, and Effect of $C_{OFS}$ on EVM Section .....	21
Added Anti-Aliasing Filter Section .....	22
Changes to Figure 54 .....	22
Changes to Figure 58 .....	24
Changes to Figure 61 .....	25
Changes to Figure 62 and Figure 63 .....	26
Changes to Table 5 .....	27

### 4/2010—Revision 0: Initial Version

## SPECIFICATIONS

VPS = 5 V, T<sub>A</sub> = 25°C, Z<sub>SOURCE</sub> = 400 Ω, Z<sub>LOAD</sub> = 1 kΩ, V<sub>OUT</sub> = 1.5 V p-p, bandwidth setting = 30 MHz, GNSW = 0 V, unless otherwise noted.

Table 1.

Parameter	Test Conditions/Comments	Min	Typ	Max	Unit
<b>FREQUENCY RESPONSE</b>					
Low-Pass Corner Frequency, $f_c$	Six-pole Butterworth filter, 0.5 dB bandwidth	1		30	MHz
Step Size			1		MHz
Corner Frequency Absolute Accuracy	Over operating temperature range		±15		% $f_c$
Corner Frequency Matching	Channel A and Channel B at same gain and bandwidth settings		±0.5		% $f_c$
Pass-Band Ripple			0.5		dB p-p
Gain Matching	Channel A and Channel B at same gain and bandwidth settings		±0.1		dB
Group Delay Variation	From midband to peak				
Corner Frequency = 1 MHz			135		ns
Corner Frequency = 30 MHz			11		ns
Group Delay Matching	Channel A and Channel B at same gain				
Corner Frequency = 1 MHz			5		ns
Corner Frequency = 30 MHz			0.2		ns
Stop-Band Rejection					
Relative to Pass Band	2 × $f_c$		30		dB
	5 × $f_c$		75		dB
<b>INPUT STAGE</b>					
Maximum Input Swing	INP1, INM1, INP2, INM2		1		V p-p
Differential Input Impedance	At minimum gain, V <sub>GAIN</sub> = 0 V		400		Ω
Input Common-Mode Range	1 V p-p input voltage	1.5		VPS/2	V
	Input pins left floating		VPS/2		V
<b>GAIN CONTROL</b>					
Voltage Gain Range	GAIN, GNSW				
	GNSW = 0 V, V <sub>GAIN</sub> from 0 V to 2 V	-5		+45	dB
	GNSW = 5 V	1		51	dB
Gain Slope			30		mV/dB
Gain Error	V <sub>GAIN</sub> from 500 mV to 1.7 V		0.2		dB
Gain Step	GNSW = 0 V to 5 V		6		dB
<b>OUTPUT STAGE</b>					
Maximum Output Swing	OPP1, OPM1, OPP2, OPM2, VOCM		2		V p-p
	At maximum gain, R <sub>LOAD</sub> = 1 kΩ		1.5		V p-p
	HD2 > 60 dBc, HD3 > 60 dBc		20		Ω
Differential Output Impedance			35		mV
Output DC Offset	Inputs shorted, offset loop disabled				
Output Common-Mode Range	1.5 V p-p output voltage	1.5		3.0	V
	VOCM left floating		VPS/2		V
<b>NOISE/DISTORTION</b>					
1 MHz Corner Frequency					
Output Noise Density	Gain = 0 dB at $f_c/2$		-129		dBV/√Hz
	Gain = 20 dB at $f_c/2$		-127		dBV/√Hz
	Gain = 40 dB at $f_c/2$		-111		dBV/√Hz
Second Harmonic, HD2	250 kHz fundamental, 1.5 V p-p output voltage				
	Gain = 0 dB		46.2		dBc
	Gain = 40 dB		43.2		dBc
Third Harmonic, HD3	250 kHz fundamental, 1.5 V p-p output voltage				
	Gain = 0 dB		52.2		dBc
	Gain = 40 dB		51.2		dBc

Parameter	Test Conditions/Comments	Min	Typ	Max	Unit
IMD3	f1 = 500 kHz, f2 = 550 kHz, 1.5 V p-p composite output voltage Gain = 5 dB Gain = 35 dB		61 57		dBc dBc
IMD3 with Input CW Blocker	f1 = 500 kHz, f2 = 550 kHz, 1.5 V p-p composite output, gain = 5 dB; blocker at 5 MHz, 10 dBc relative to two-tone composite output voltage		40		dBc
30 MHz Corner Frequency	Midband, gain = 0 dB		-130		dBV/ $\sqrt{\text{Hz}}$
Output Noise Density	Midband, gain = 20 dB		-130		dBV/ $\sqrt{\text{Hz}}$
	Midband, gain = 40 dB		-123		dBV/ $\sqrt{\text{Hz}}$
Second Harmonic, HD2	8 MHz fundamental, 1.5 V p-p output voltage Gain = 0 dB Gain = 40 dB		63 84		dBc dBc
Third Harmonic, HD3	8 MHz fundamental, 1.5 V p-p output voltage Gain = 0 dB Gain = 40 dB		54 87		dBc dBc
IMD3	f1 = 15 MHz, f2 = 16 MHz, 1.5 V p-p composite output voltage Gain = 5 dB Gain = 35 dB		59 77.5		dBc dBc
IMD3 with Input CW Blocker	f1 = 15 MHz, f2 = 16 MHz, 1.5 V p-p composite output, gain = 5 dB; blocker at 150 MHz, 10 dBc relative to two-tone composite output voltage		55		dBc
DIGITAL LOGIC	LE, CLK, DATA, SDO, OFDS, GNSW				
Input High Voltage, V <sub>INH</sub>			>2		V
Input Low Voltage, V <sub>INL</sub>			<0.8		V
Input Current, I <sub>INH</sub> /I <sub>INL</sub>			<1		$\mu\text{A}$
Input Capacitance, C <sub>IN</sub>			2		pF
SPI TIMING	LE, CLK, DATA, SDO				
f <sub>CLK</sub>	1/t <sub>CLK</sub>		20		MHz
t <sub>DH</sub>	DATA hold time		5		ns
t <sub>DS</sub>	DATA setup time		5		ns
t <sub>LH</sub>	LE hold time		5		ns
t <sub>LS</sub>	LE setup time		5		ns
t <sub>PW</sub>	CLK high pulse width		5		ns
t <sub>D</sub>	CLK to SDO delay		5		ns
POWER AND ENABLE	VPS, VPSD, COM, COMD, ENBL				
Supply Voltage Range		4.75	5.0	5.25	V
Total Supply Current	ENBL = 5 V Maximum bandwidth setting Minimum bandwidth setting		258 131		mA mA
Disable Current	ENBL = 0 V		2		mA
Disable Threshold			2.5		V
Enable Response Time	Delay following ENBL low-to-high transition		20		$\mu\text{s}$
Disable Response Time	Delay following ENBL high-to-low transition		300		ns

TIMING DIAGRAMS

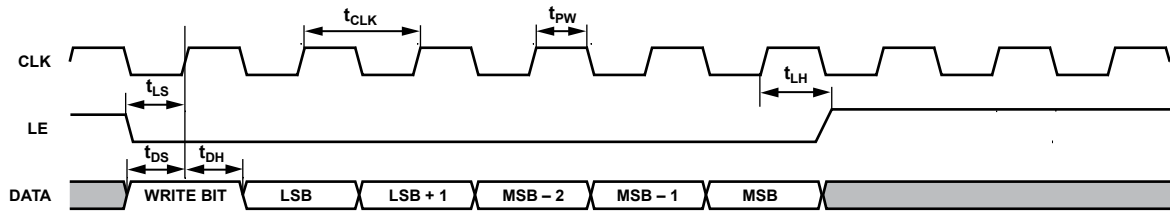

NOTES

1. THE FIRST DATA BIT DETERMINES WHETHER THE PART IS WRITING TO OR READING FROM THE INTERNAL CORNER FREQUENCY WORD REGISTER. FOR A WRITE OPERATION, THE FIRST BIT SHOULD BE A LOGIC 1. THE CORNER FREQUENCY WORD BIT IS THEN REGISTERED INTO THE DATA PIN ON CONSECUTIVE RISING EDGES OF THE CLOCK.

09002-003

Figure 2. Write Mode Timing Diagram

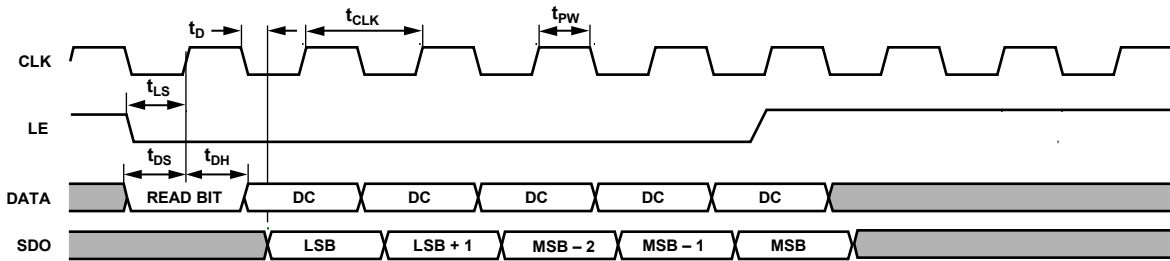

NOTES

1. THE FIRST DATA BIT DETERMINES WHETHER THE PART IS WRITING TO OR READING FROM THE INTERNAL CORNER FREQUENCY WORD REGISTER. FOR A READ OPERATION, THE FIRST BIT SHOULD BE A LOGIC 0. THE CORNER FREQUENCY WORD BIT IS THEN UPDATED AT THE SDO PIN ON CONSECUTIVE FALLING EDGES OF THE CLOCK.

09002-004

Figure 3. Read Mode Timing Diagram

## ABSOLUTE MAXIMUM RATINGS

Table 2.

Parameter	Rating
Supply Voltages, VPS, VPSD	5.25 V
ENBL, GNSW, OFDS, LE, CLK, DATA, SDO	VPS + 0.6 V
INP1, INM1, INP2, INM2	VPS + 0.6 V, GND – 0.6 V
OPP1, OPM1, OPP2, OPM2	VPS + 0.6 V
OFS1, OFS2	VPS + 0.6 V
GAIN	VPS + 0.6 V
Internal Power Dissipation	1.4 W
$\theta_{JA}$ (Exposed Pad Soldered to Board)	37.4°C/W
Maximum Junction Temperature	150°C
Operating Temperature Range	–40°C to +85°C
Storage Temperature Range	–65°C to +150°C
Lead Temperature (Soldering 60 sec)	300°C

Stresses at or above those listed under Absolute Maximum Ratings may cause permanent damage to the product. This is a stress rating only; functional operation of the product at these or any other conditions above those indicated in the operational section of this specification is not implied. Operation beyond the maximum operating conditions for extended periods may affect product reliability.

### ESD CAUTION



**ESD (electrostatic discharge) sensitive device.** Charged devices and circuit boards can discharge without detection. Although this product features patented or proprietary protection circuitry, damage may occur on devices subjected to high energy ESD. Therefore, proper ESD precautions should be taken to avoid performance degradation or loss of functionality.

## PIN CONFIGURATION AND FUNCTION DESCRIPTIONS

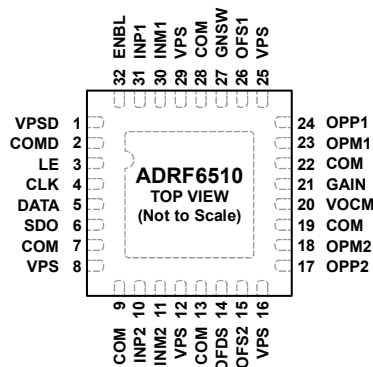

NOTES  
1. CONNECT THE EXPOSED PADDLE TO A LOW IMPEDANCE GROUND PAD.

09002-002

Figure 4. Pin Configuration

Table 3. Pin Function Descriptions

Pin No.	Mnemonic	Description
1	VPSD	Digital Positive Supply Voltage: 4.75 V to 5.25 V.
2	COMD	Digital Common. Connect to external circuit common using the lowest possible impedance.
3	LE	Latch Enable. SPI programming pin. CMOS levels: $V_{LOW} < 0.8 V$ , $V_{HIGH} > 2 V$ .
4	CLK	SPI Port Clock. CMOS levels: $V_{LOW} < 0.8 V$ , $V_{HIGH} > 2 V$ .
5	DATA	SPI Data Input. CMOS levels: $V_{LOW} < 0.8 V$ , $V_{HIGH} > 2 V$ .
6	SDO	SPI Data Output. CMOS levels: $V_{LOW} < 0.8 V$ , $V_{HIGH} > 2 V$ .
7, 9, 13, 19, 22, 28	COM	Analog Common. Connect to external circuit common.
8, 12, 16, 25, 29	VPS	Analog Positive Supply Voltage: 4.75 V to 5.25 V.
10, 11, 30, 31	INP2, INM2, INM1, INP1	Differential Inputs. 400 $\Omega$ input impedance. Common-mode range is 1.5 V to 2.5 V; default is 2.1 V.
14	OFDS	Offset Correction Loop Disable. Pull high to disable the offset correction loop.
15, 26	OFS2, OFS1	Offset Correction Loop Compensation Capacitors. Connect capacitors to circuit common.
17, 18, 23, 24	OPP2, OPM2, OPM1, OPP1	Differential Outputs. 20 $\Omega$ output impedance. Common-mode range is 1.5 V to 3 V; default is $VPS/2$ .
20	VOCCM	Output Common-Mode Setpoint. Defaults to $VPS/2$ if left open.
21	GAIN	Analog Gain Control. 0 V to 2 V, 30 mV/dB gain scaling.
27	GNSW	Front-End Gain Switch, 6 dB or 12 dB. Pull low for 6 dB; pull high for 12 dB.
32	ENBL	Chip Enable. Pull high to enable.
	EP	Exposed Paddle. Connect the exposed paddle to a low impedance ground pad.

TYPICAL PERFORMANCE CHARACTERISTICS

VPS = 5 V, T<sub>A</sub> = 25°C, Z<sub>SOURCE</sub> = 400 Ω, Z<sub>LOAD</sub> = 1 kΩ, V<sub>OUT</sub> = 1.5 V p-p, GNSW = 0 V, unless otherwise noted.

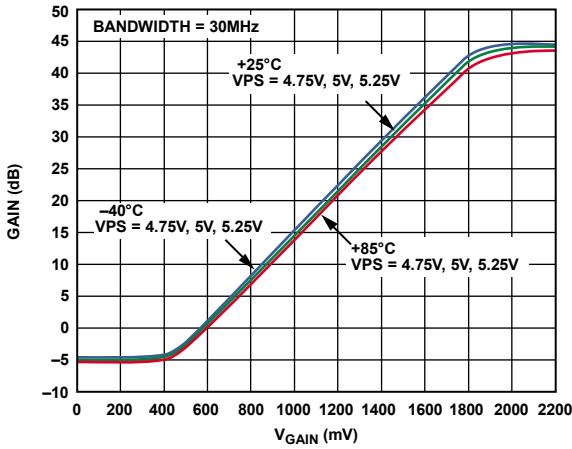

Figure 5. In-Band Gain vs. V<sub>GAIN</sub> over Supply and Temperature (Bandwidth Setting = 30 MHz)

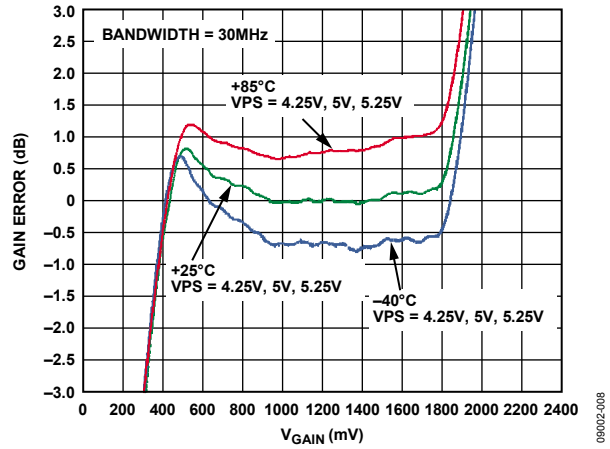

Figure 8. Gain Conformance vs. V<sub>GAIN</sub> over Supply and Temperature (Bandwidth Setting = 30 MHz)

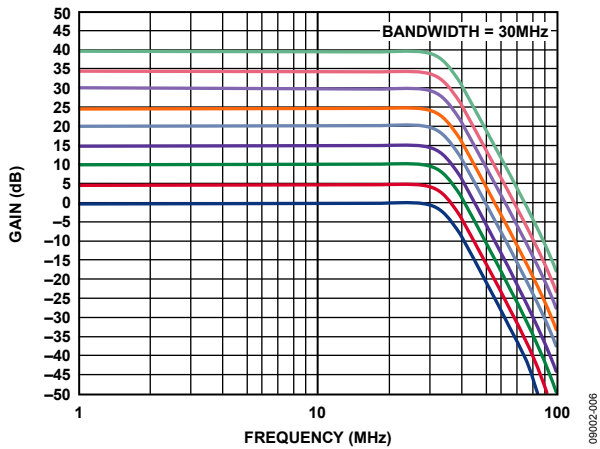

Figure 6. Gain vs. Frequency by V<sub>GAIN</sub> (Bandwidth Setting = 30 MHz)

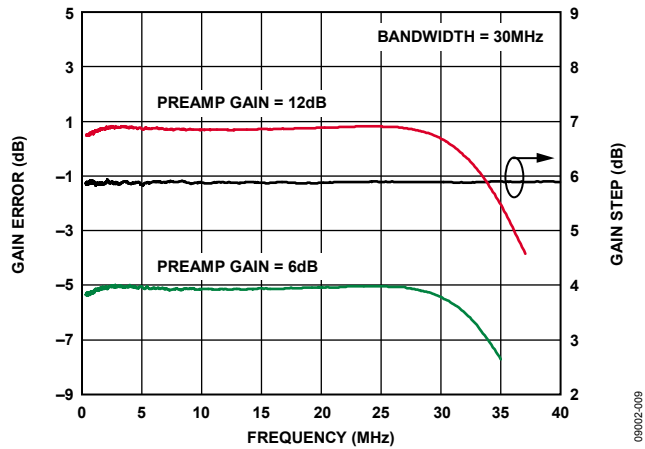

Figure 9. 6 dB Gain Step and Gain Error vs. Frequency (Bandwidth Setting = 30 MHz, V<sub>GAIN</sub> = 0 V)

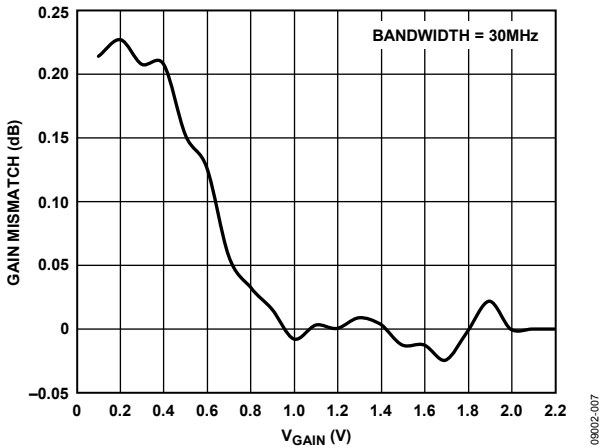

Figure 7. Gain Matching vs. V<sub>GAIN</sub> (Bandwidth Setting = 30 MHz)

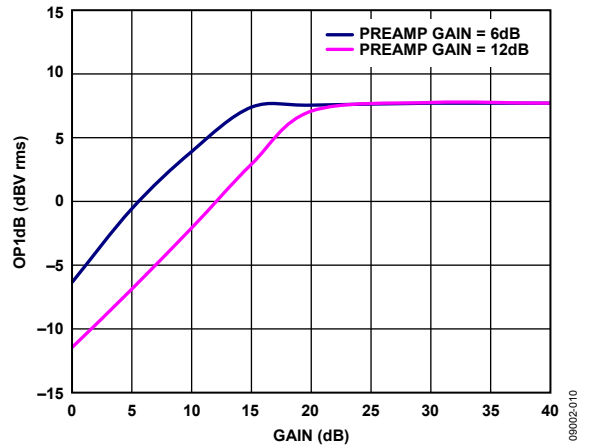

Figure 10. Output P1dB vs. GAIN at 15 MHz (Bandwidth Setting = 30 MHz)



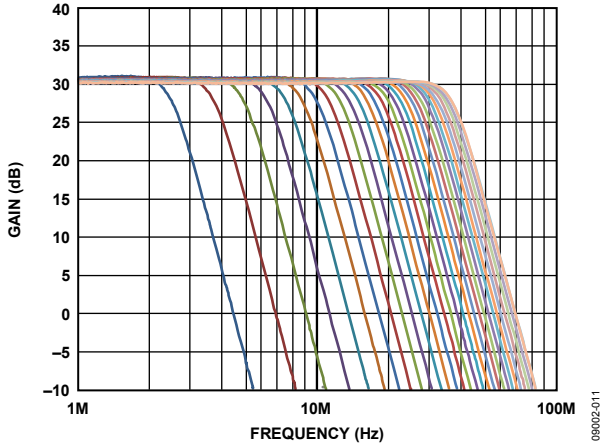

Figure 11. Frequency Response vs. Bandwidth Setting (Gain = 30 dB), Log Scale

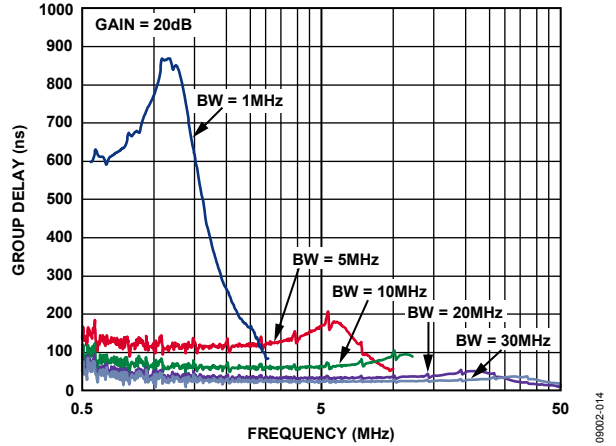

Figure 14. Group Delay vs. Frequency (Gain = 20 dB)

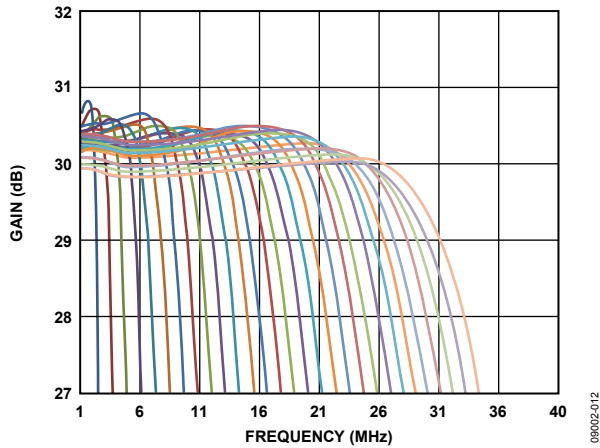

Figure 12. Frequency Response vs. Bandwidth Setting (Gain = 30 dB), Linear Scale

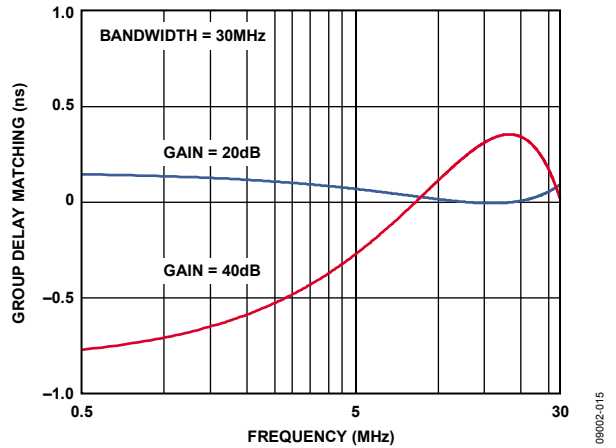

Figure 15. Group Delay Mismatch vs. Frequency (Bandwidth Setting = 30 MHz)

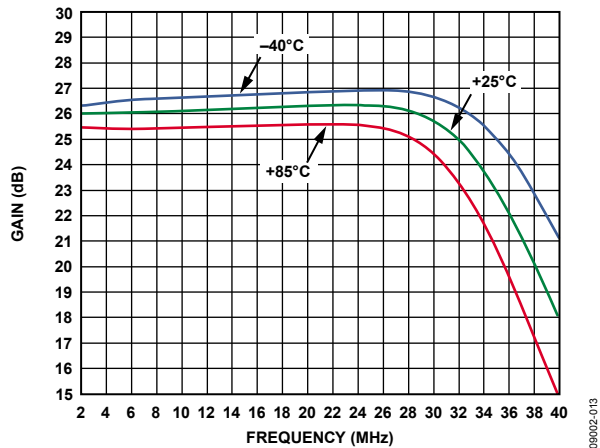

Figure 13. Frequency Response over Temperature (Gain = 26 dB, Bandwidth Setting = 30 MHz)

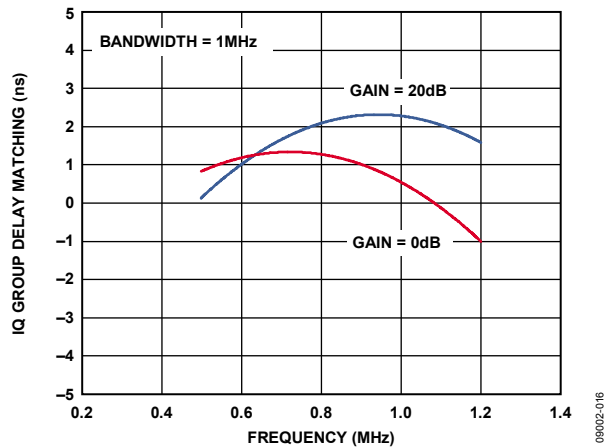

Figure 16. IQ Group Delay Mismatch vs. Frequency (Bandwidth Setting = 1 MHz)

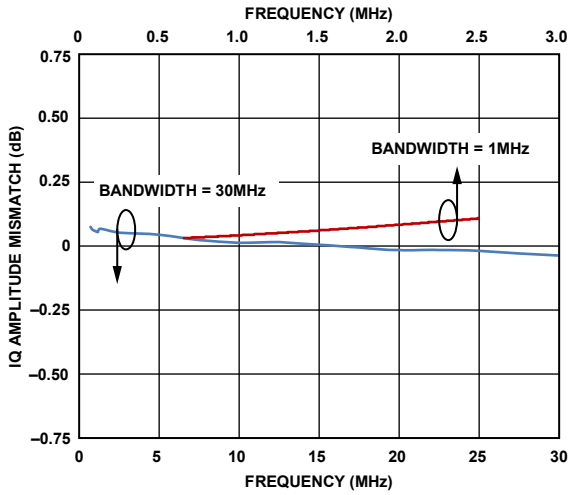

Figure 17. IQ Amplitude Mismatch vs. Frequency

09002-017

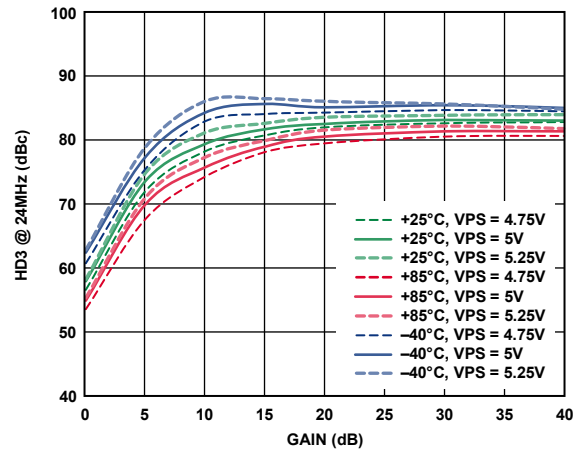

Figure 20. HD3 vs. Gain over Supply and Temperature (Bandwidth Setting = 30 MHz)

09002-020

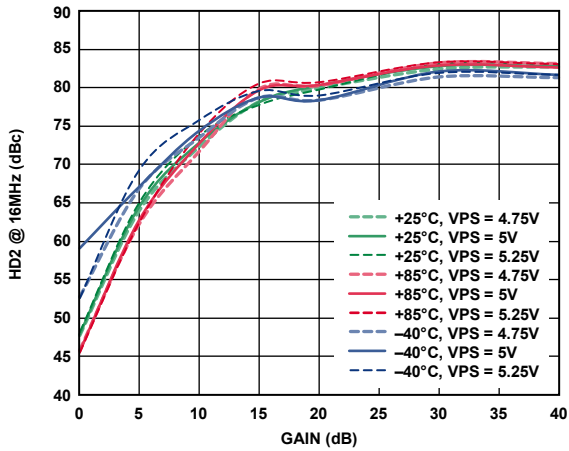

Figure 18. HD2 vs. Gain over Supply and Temperature (Bandwidth Setting = 30 MHz)

09002-018

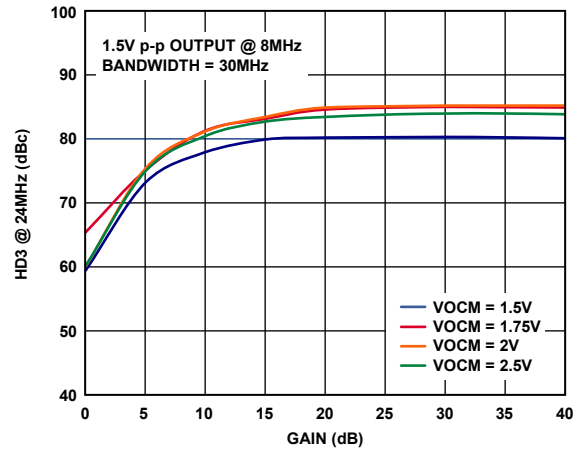

Figure 21. HD3 vs. Gain over Output Common-Mode Voltage (Bandwidth Setting = 30 MHz)

09002-021

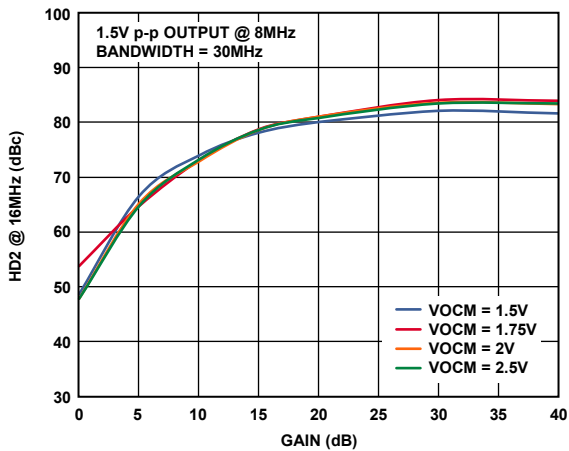

Figure 19. HD2 vs. Gain over Output Common-Mode Voltage (Bandwidth Setting = 30 MHz)

09002-019

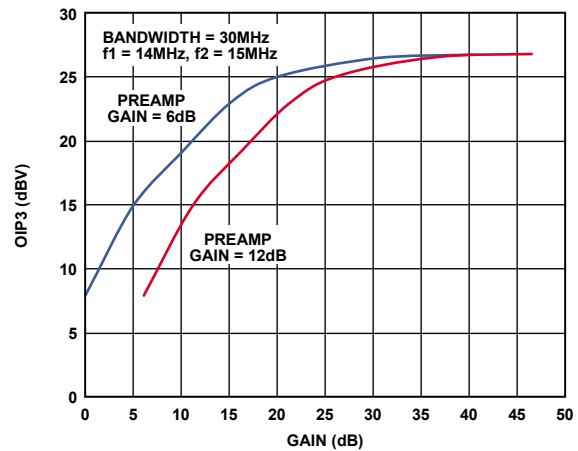

Figure 22. In-Band OIP3 vs. Gain (Bandwidth Setting = 30 MHz)

09002-022

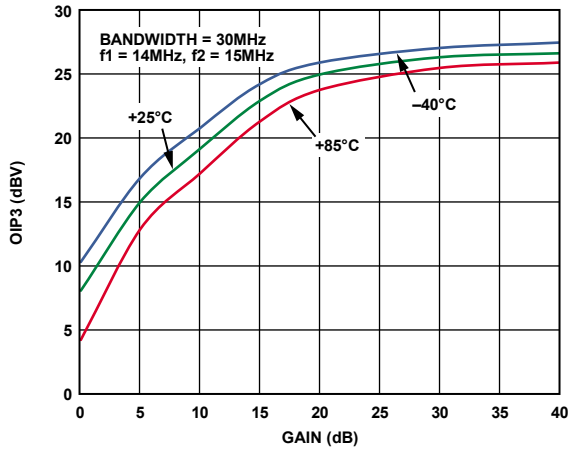

Figure 23. In-Band OIP3 vs. Gain over Temperature (Preamp Gain = 6 dB, Bandwidth Setting = 30 MHz)

09002-023

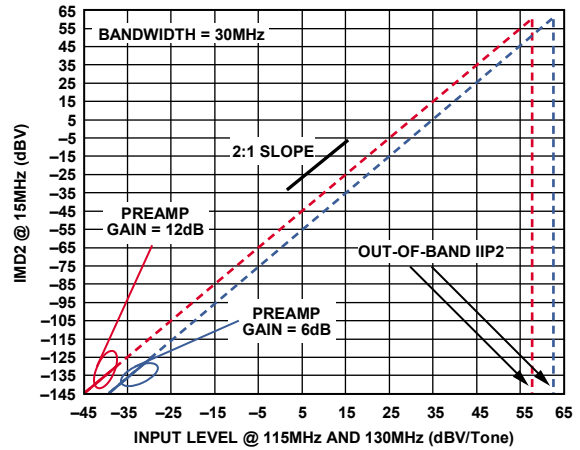

Figure 26. Out-of-Band IIP2: IMD2 Tone at Midband (Bandwidth Setting = 30 MHz)

09002-060

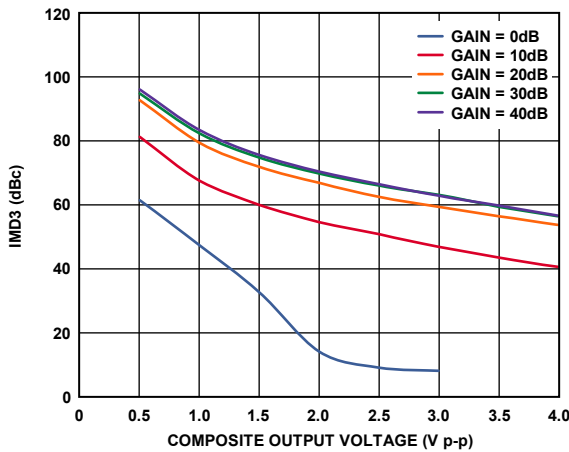

Figure 24. In-Band Third-Order Intermodulation Distortion (Preamp Gain = 6 dB, Bandwidth Setting = 30 MHz)

09002-024

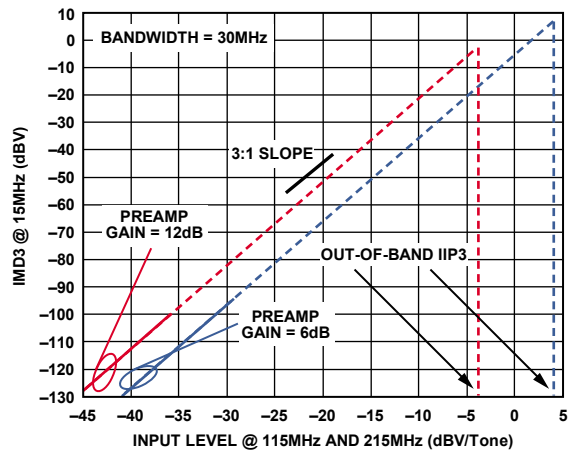

Figure 27. Out-of-Band IIP3: IMD3 Tone at Midband (Bandwidth Setting = 30 MHz)

09002-027

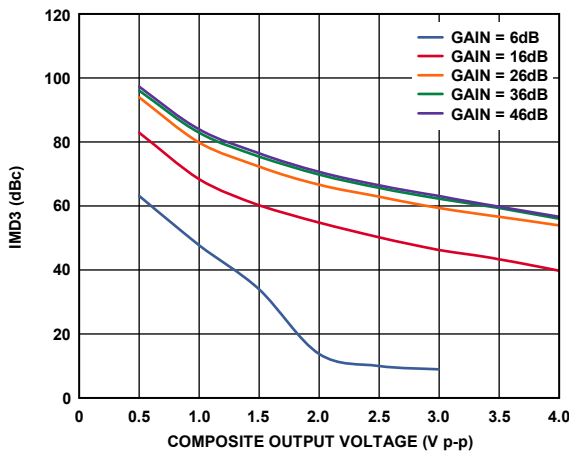

Figure 25. In-Band Third-Order Intermodulation Distortion (Preamp Gain = 12 dB, Bandwidth Setting = 30 MHz)

09002-025

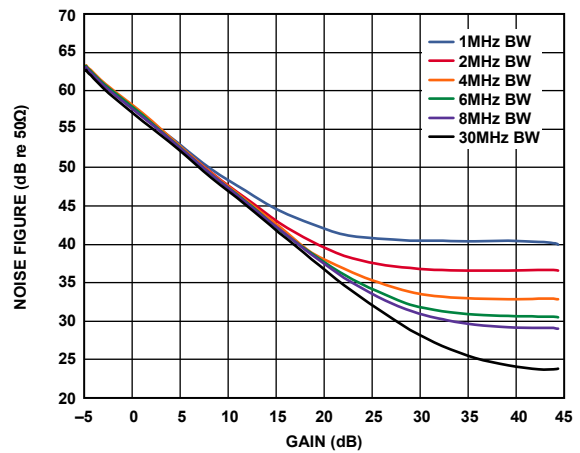

Figure 28. Noise Figure vs. Gain over Bandwidth Setting, Preamp Gain = 6 dB (Noise Figure at 1/2 Bandwidth)

09002-028

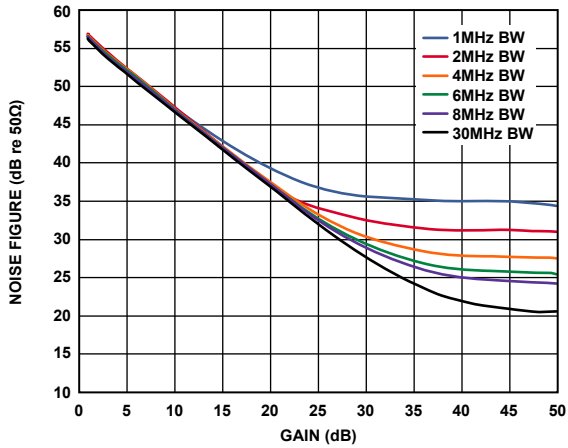

Figure 29. Noise Figure vs. Gain over Bandwidth Setting, Preamp Gain = 12 dB (Noise Figure at 1/2 Bandwidth)

09002-029

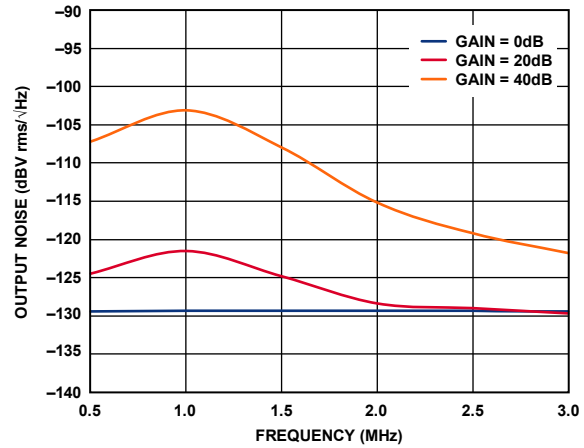

Figure 32. Output Noise Density vs. Frequency (Bandwidth Setting = 1 MHz)

09002-032

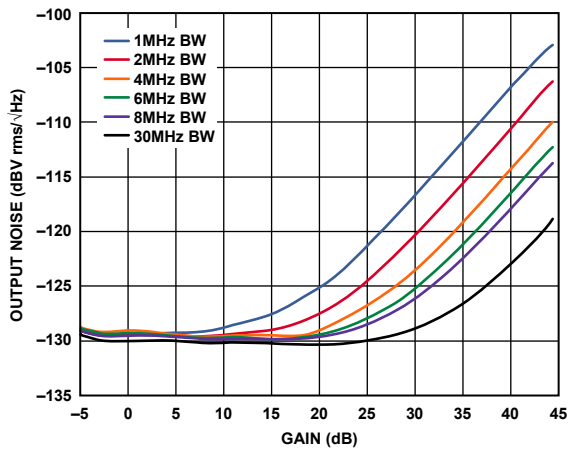

Figure 30. Output Noise Density vs. Gain by Bandwidth Setting, Preamp Gain = 6 dB (Noise at 1/2 Bandwidth)

09002-030

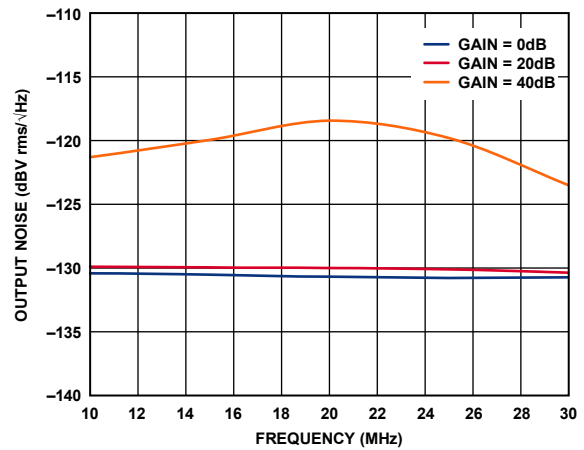

Figure 33. Output Noise Density vs. Frequency (Bandwidth Setting = 20 MHz)

09002-033

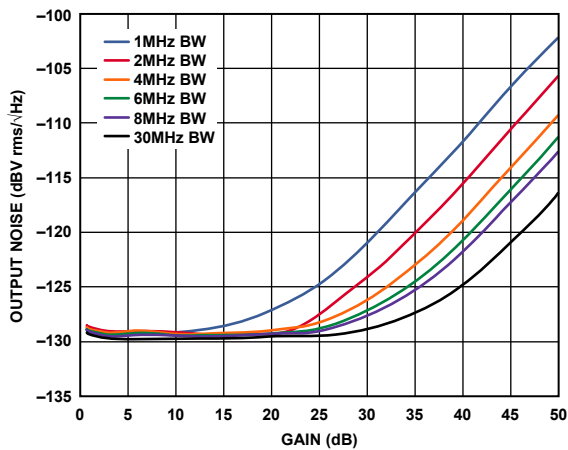

Figure 31. Output Noise Density vs. Gain by Bandwidth Setting, Preamp Gain = 12 dB (Noise at 1/2 Bandwidth)

09002-031

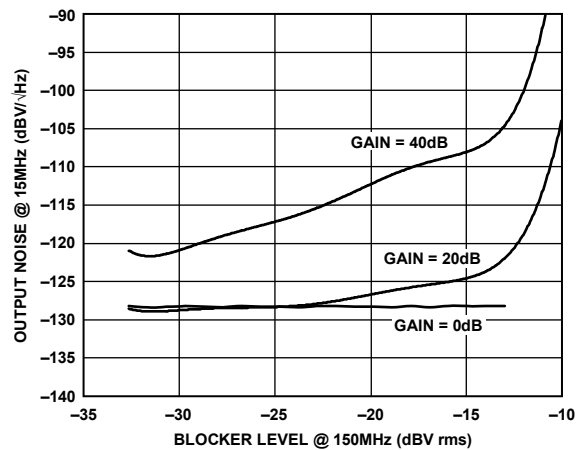

Figure 34. Output Noise Density vs. Blocker Level (Bandwidth Setting = 30 MHz, Blocker at 150 MHz)

09002-034

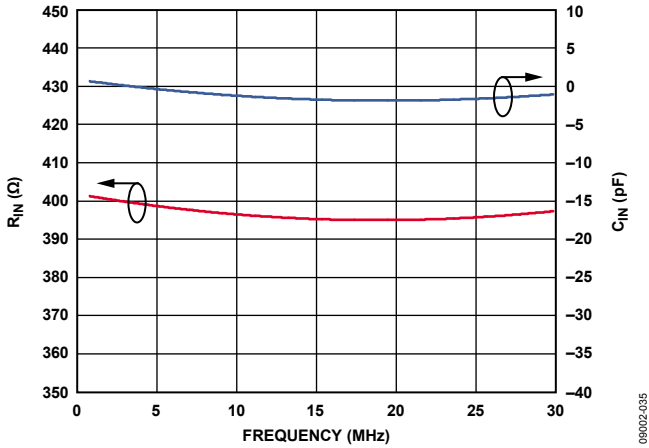

Figure 35. Input Impedance vs. Frequency (Bandwidth Setting = 30 MHz)

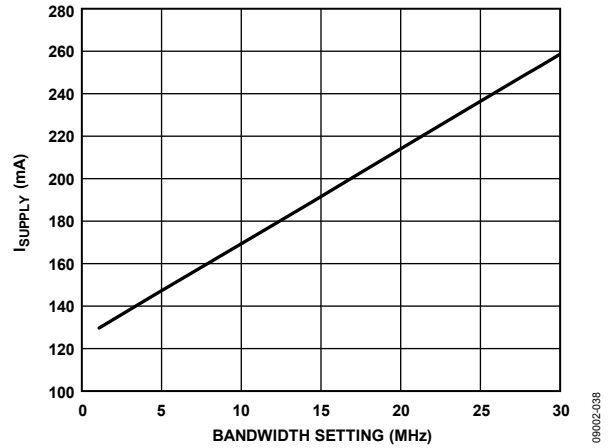

Figure 38. Current Consumption vs. Bandwidth Setting (Gain = 20 dB)

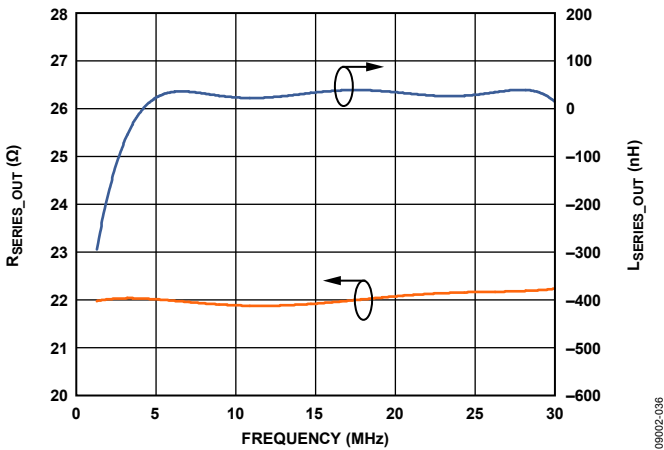

Figure 36. Output Impedance vs. Frequency (Bandwidth Setting = 30 MHz)

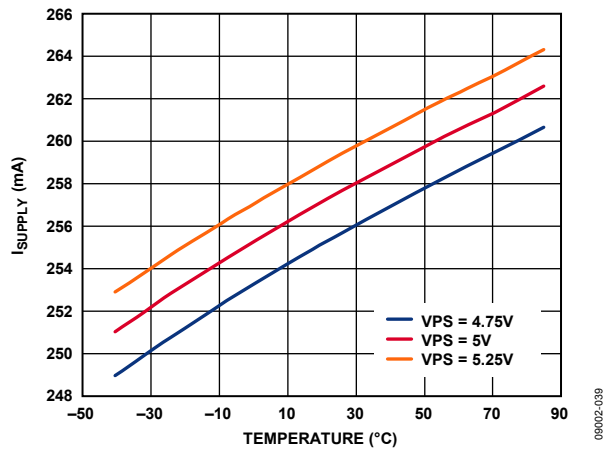

Figure 39. Current Consumption vs. Temperature over Supply (Bandwidth Setting = 30 MHz)

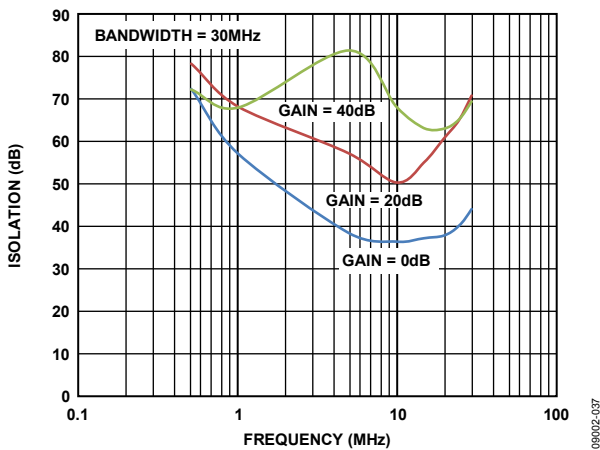

Figure 37. Channel Isolation, Output to Output, vs. Frequency (Bandwidth Setting = 30 MHz)

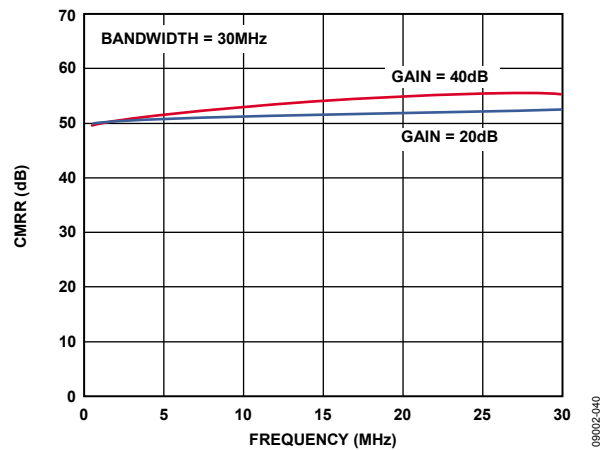

Figure 40. Common-Mode Rejection Ratio vs. Frequency (Bandwidth Setting = 30 MHz)

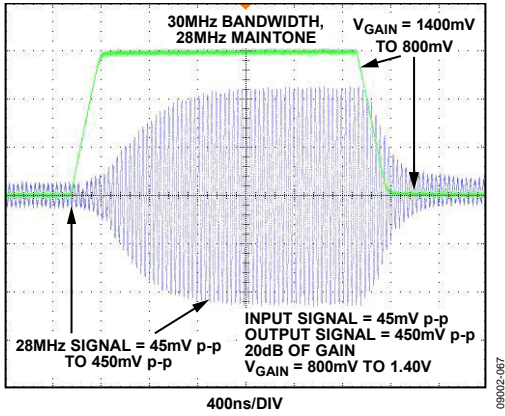

Figure 41. Gain Step Response

## THEORY OF OPERATION

The **ADRF6510** consists of a matched pair of buffered, programmable filters followed by variable gain amplifiers and output ADC drivers. The block diagram of a single channel is shown in Figure 42. The programmability of the bandwidth and of the pre- and post-filtering gain offers great flexibility when coping with signals of varying levels in the presence of noise and large, undesired signals nearby. The entire differential signal chain is dc-coupled with flexible interfaces at the input and output. The bandwidth and gain setting controls for the two channels are shared, ensuring close matching of their magnitude and phase responses. The **ADRF6510** can be fully disabled through the ENBL pin.

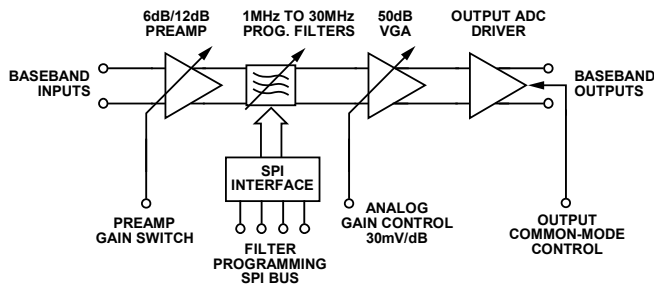

Figure 42. Signal Path Block Diagram for a Single Channel of the **ADRF6510**

Filtering and amplification are fundamental operations in any signal processing system. Filtering is necessary to select the intended signal while rejecting out-of-band noise and interferers. Amplification increases the level of the desired signal to overcome noise added by the system. When used together, filtering and amplification can extract a low level signal of interest in the presence of noise and out-of-band interferers. Such analog signal processing alleviates the requirements on the analog, mixed signal, and digital components that follow.

### INPUT BUFFERS

The input buffers provide a convenient interface to the sensitive filter sections that follow. They set a differential input impedance of 400 Ω and sit at a nominal common-mode voltage of VPS/2. The inputs can be dc-coupled or ac-coupled. If using direct dc-coupling, the common-mode voltage, V<sub>CM</sub>, can range from 1.5 V to 3 V. A current flows into or out of the input pins to accommodate the difference in common-mode voltages. The current into each pin is given by

$$(V_{CM} - (VPS/2))/200 \Omega$$

The input buffers in both channels can be configured simultaneously to a gain of 6 dB or 12 dB through the GNSW pin. When configured for a 6 dB gain, the buffers support up to a 1 V p-p differential input level with >50 dBc harmonic distortion. For a 12 dB gain setting, the buffers support 0.5 V p-p inputs.

### PROGRAMMABLE FILTERS

The integrated programmable filter is the key signal processing function in the **ADRF6510**. The filters follow a six-pole Butterworth prototype response that provides a compromise between

band rejection, ripple, and group delay. The 0.5 dB bandwidth is programmed from 1 MHz to 30 MHz in 1 MHz steps via the serial programming interface (SPI) as described in the Programming the Filters section.

The filters are designed so that the Butterworth prototype filter shape and group delay responses vs. frequency are retained for any bandwidth setting. Figure 43 and Figure 44 illustrate the ideal six-pole Butterworth gain and group delay responses, respectively. The group delay, τ<sub>g</sub>, is defined as

$$\tau_g = -\partial\phi/\partial\omega$$

where:

φ is the phase in radians.

ω = 2πf is the frequency in radians/second.

Note that for a frequency scaled filter prototype, the absolute magnitude of the group delay scales inversely with the bandwidth; however, the shape is retained. For example, the peak group delay for a 28 MHz bandwidth setting is 14× less than for a 2 MHz setting.

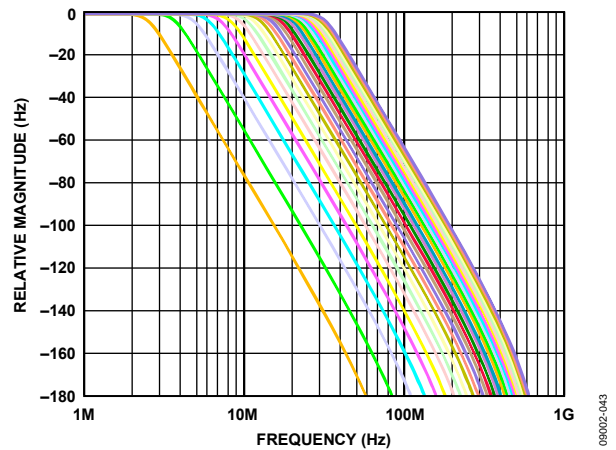

Figure 43. Sixth-Order Butterworth Magnitude Response for 0.5 dB Bandwidths; Programmed from 2 MHz to 29 MHz in 1 MHz Steps

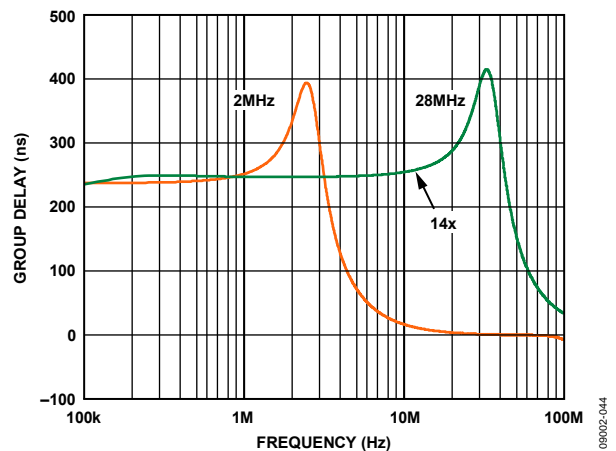

Figure 44. Sixth-Order Butterworth Group Delay Response for 0.5 dB Bandwidths; Programmed to 2 MHz and 28 MHz

The corner frequency of the filters is defined by RC products, which can vary by ±30% in a typical process. Therefore, all the parts are factory calibrated for corner frequency, resulting in a residual ±10% corner frequency variation over the -40°C to +85°C temperature range. Although absolute accuracy requires calibration, the matching of RC products between the pair of channels is better than 1% by observing careful design and layout practices. Calibration and excellent matching ensure that the magnitude and group delay responses of both channels track together, a critical requirement for digital IQ-based communication systems.

**VARIABLE GAIN AMPLIFIERS (VGAs)**

The VGAs are implemented using the Analog Devices, Inc., patented X-AMP® architecture, consisting of a tapped 50 dB attenuator followed by a fixed-gain amplifier. The X-AMP architecture generates a linear-in-dB monotonic gain response with low ripple. The gain is controlled through the high impedance GAIN pin with an accurate slope of 30 mV/dB. The gain response shown in Figure 45 shows the GAIN pin voltage range and the absence of gain foldback at high V<sub>GAIN</sub>.

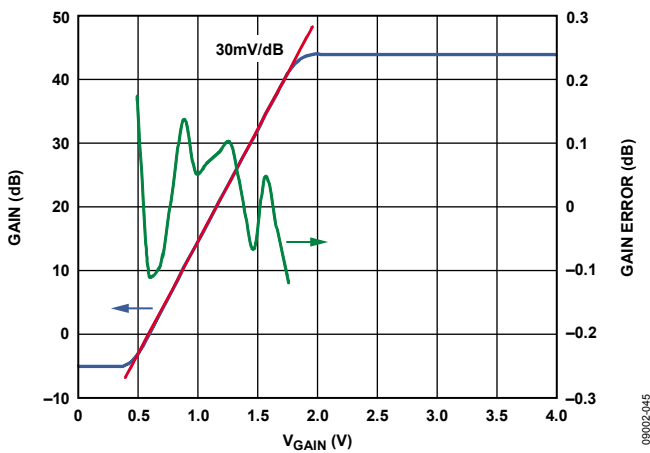

Figure 45. Linear-in-dB Gain Control Response of the X-AMP VGA Showing Consistent Slope and Low Error

**OUTPUT BUFFERS/ADC DRIVERS**

The low impedance (20 Ω) output buffers of the ADRF6510 are designed to drive either ADC inputs or subsequent amplifier stages. They are capable of delivering up to 4 V p-p composite two-tone signals into 500 Ω differential loads with >60 dBc IM3. The output common-mode voltage defaults to V<sub>PS</sub>/2, but it can be adjusted from 1.5 V to 3.0 V without loss of drive capability by presenting the VO<sub>CM</sub> pin with the desired common-mode voltage. The high input impedance of VO<sub>CM</sub> allows the ADC reference output to be connected directly. Even though the signal path is fully dc-coupled and the dc offset compensation loop can remove undesired dc offsets (see the DC Offset Compensation Loop section), the output buffers can be ac-coupled to the next stage by properly selecting the coupling capacitors according to the load impedance.

**DC OFFSET COMPENSATION LOOP**

In many signal processing applications, no information is carried in the dc level. In fact, dc voltages and other low frequency disturbances can often dominate the intended signal and consume precious dynamic range in the analog path and bits in the data converters. These dc voltages can be present with the desired input signal or can be generated inside the signal path by inherent dc offsets or other unintended signal-dependent processes such as self-mixing or rectification.

Because the ADRF6510 is fully dc-coupled, it may be necessary to remove these offsets to realize the maximum signal-to-noise ratio (SNR). This can be achieved with ac-coupling capacitors at the input and output pins, but that requires large values because the impedances are fairly low, and high-pass corners may need to be <10 Hz in some cases. To address the issue of dc offsets, the ADRF6510 provides an offset correction loop that nulls the output differential dc level as shown in Figure 46. If the correction loop is not required, it can be disabled through the OFDS pin.

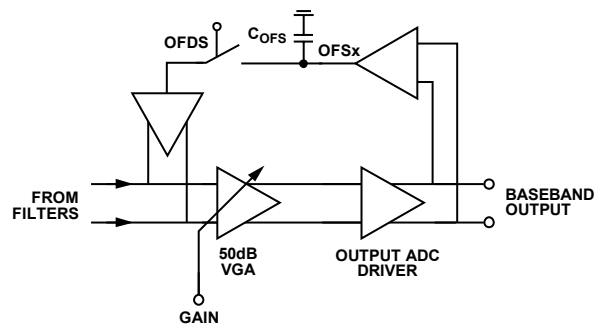

Figure 46. Offset Compensation Loop Operation around the VGA and Output Buffer

The offset control loop creates a high-pass corner, f<sub>HP</sub>, that is superimposed on the normal Butterworth filter response. Typically, f<sub>HP</sub> is many orders of magnitude lower than the lower programmed filter bandwidth so that there is no interaction between them. Setting f<sub>HP</sub> is accomplished with capacitors, C<sub>OFS</sub>, from the OFS1 and OFS2 pins to ground. Because the correction loop works around the VGA section, f<sub>HP</sub> is also dependent on the gain of the VGA. In general, the expression for f<sub>HP</sub> is given by

$$f_{HP} \text{ (Hz)} = 1.2 \times (\text{Gain}/C_{OFS})$$

where:

Gain is expressed in linear terms, not in decibels (dB).

C<sub>OFS</sub> is expressed in microfarads (μF).

Note that f<sub>HP</sub> increases in proportion to the gain. For this reason, C<sub>OFS</sub> should be chosen at the highest operating gain to guarantee that f<sub>HP</sub> is always below the maximum limit required by the system.



**PROGRAMMING THE FILTERS**

The 0.5 dB corner frequencies for both filters are programmed simultaneously through the SPI port. A 5-bit register stores the codes for corner frequencies of 1 MHz through 30 MHz (see Table 4). The SPI protocol not only allows frequency codes to be written to the DATA pin but also allows the stored code to be read back from the SDO pin.

The latch enable (LE) pin must first go to a Logic 0 for a read or write cycle to begin. On the next rising edge of the clock (CLK), a Logic 1 on the DATA pin initiates a write cycle, whereas a Logic 0 on the DATA pin initiates a read cycle. In a write cycle, the next five CLK rising edges latch the frequency code, LSB first. When LE goes high, the write cycle is completed and the frequency code is presented to the filter. In a read cycle, the next five CLK falling edges present the stored frequency code, LSB first. When LE goes high, the read cycle is completed. Detailed timing diagrams are shown in Figure 2 and Figure 3.

**Table 4. Frequency Code vs. Corner Frequency Lookup Table**

5-Bit Binary Frequency Code <sup>1</sup>	Corner Frequency (MHz)
00000	1
00001	2
00010	3
00011	4
00100	5
00101	6
00110	7
00111	8
01000	9
01001	10
01010	11
01011	12
01100	13
01101	14
01110	15
01111	16
10000	17
10001	18
10010	19
10011	20
10100	21
10101	22
10110	23
10111	24
11000	25
11001	26
11010	27
11011	28
11100	29
11101	30
11110	30
11111	30

<sup>1</sup> MSB first.

**NOISE CHARACTERISTICS**

The output noise behavior of the ADRF6510 depends on the gain and bandwidth settings. Both the filter sections and the VGAs contribute to the total noise at the output. The filter contributes a noise spectral density profile that is flat at low frequencies, peaks near the corner frequency, and then rolls off as the filter poles roll off the gain. The magnitude of the noise spectral density, expressed in nV/√Hz, varies inversely with the square root of the bandwidth setting, resulting in a total integrated noise in nV that is nearly constant with bandwidth setting.

The X-AMP type VGAs used in the ADRF6510 contribute a fixed noise spectral density to the output, independent of the gain setting, of -130 dBV/√Hz, which is equivalent to 316 nV/√Hz. Although the VGA noise contribution to the output is fixed, the gain of the VGA controls the relative contribution of the filter noise.

Figure 47 and Figure 48 show the total output noise spectral density vs. frequency for different bandwidth settings. At low values of VGA gain, the noise at the output is the flat spectral density contributed by the VGA because the filter noise is suppressed by the VGA attenuation. As the gain increases, more of the filter noise appears at the output. Because the filter noise increases at lower bandwidth settings, it overwhelms the VGA noise floor. In either case, the noise density asymptotically approaches the -130 dBV/√Hz limit set by the VGA at the highest frequencies. For other values of VGA gain and bandwidth setting, the detailed shape of the noise spectral density changes.

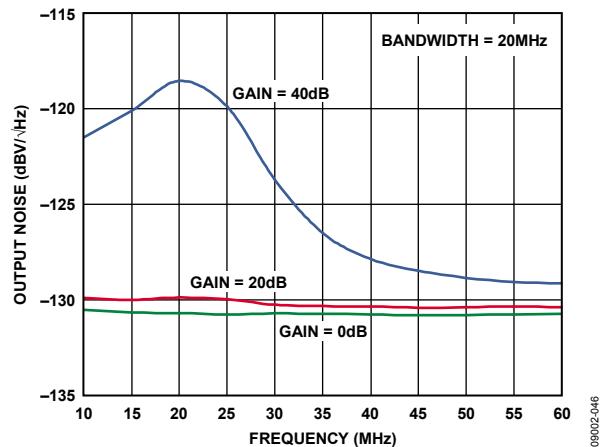

Figure 47. Total Output Noise with a 20 MHz Corner Frequency for Three Different Gain Settings

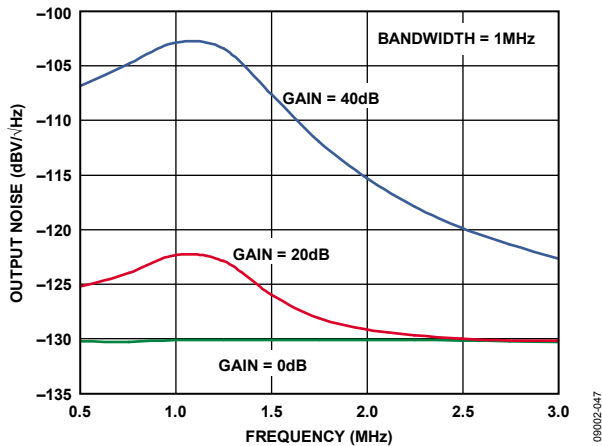

Figure 48. Total Output Noise with a 1 MHz Corner Frequency for Three Different Gain Settings

Note that the noise spectral density outside the filter bandwidth is limited by the fixed VGA output noise. It may be necessary to use an external, fixed-frequency, passive filter prior to an analog-to-digital conversion to prevent noise aliasing from degrading the signal-to-noise ratio. The higher the sampling rate relative to the maximum [ADRF6510](#) corner frequency setting to be used, the lower the order of the external filter.

## DISTORTION CHARACTERISTICS

The distortion performance of the [ADRF6510](#) is similar to its noise performance. The filters and the VGAs contribute to the overall distortion and signal handling capabilities. Furthermore, the front end must also cope with out-of-band signals that can be larger than the in-band signals. These out-of-band signals are filtered before reaching the VGA. It is important to understand the signals presented to the [ADRF6510](#) and to match these signals with the input and output characteristics of the part.

When the gain is low, the distortion is typically limited by the input section because the output is not driven to its maximum capacity. When the gain is high, the distortion is likely limited by the output section because the input is not driven to its maximum capacity. An exception to this is when the input is driven with a small desired signal in combination with a large out-of-band signal. In this case, the out-of-band signal may drive the input to distort. As long as the input is not overdriven, the out-of-band signal is removed by the filter. A high VGA gain is still needed to raise the small desired signal to a higher level at the output. The overall distortion introduced by the part depends on the input drive level, including the out-of-band signals, and the desired output signal level.

As noted in the Input Buffers section, the input section can handle a total signal level of 1 V p-p for a 6 dB preamplifier and 500 mV p-p for a 12 dB preamplifier with >50 dBc harmonic distortion. This includes both in-band and out-of-band signals.

To distinguish and quantify the distortion performance of the input section, two different IP3 specifications are presented. The first is called in-band IP3 and refers to a two-tone test where the signals are inside the filter bandwidth. This is exactly the same figure of merit familiar to communications engineers in which the third-order intermodulation level, IM3, is measured.

To quantify the effect of out-of-band signals, a new out-of-band (OOB) IIP3 figure of merit is introduced. This test also involves a two-tone stimulus; however, the two tones are placed out-of-band so that the lower IM3 product lands in the middle of the filter pass band. At the output, only the IM3 product is visible because the original two tones are filtered out. To calculate the OOB IP3 at the input, the IM3 level is referred to the input by the overall gain. The OOB IIP3 allows the user to predict the impact of out-of-band blockers or interferers at an arbitrary signal level on the in-band performance. The ratio of the desired input signal level to the input-referred IM3 at a given blocker level represents a signal-to-distortion limit imposed by the out-of-band signals.

## MAXIMIZING THE DYNAMIC RANGE

The role of the [ADRF6510](#) is to increase the level of a variable in-band signal while minimizing out-of-band signals. Ideally, this is achieved without degrading the SNR of the incoming signal or introducing distortion to the incoming signal.

The first goal is to maximize the output signal swing, which can be defined by the ADC input range or the input signal capacity of the next analog stage. For the complex waveforms often encountered in communication systems, the peak-to-average ratio, or crest factor, must be considered when choosing the peak-to-peak output. From the chosen output signal and the maximum gain of the [ADRF6510](#), the minimum input level can be defined. Lower signal levels do not yield the maximum output and suffer a greater degradation in SNR.

As the input signal level increases, the VGA gain is reduced from its maximum gain point to maintain the desired fixed output level. The output noise, initially dominated by the filter, follows the gain reduction, yielding a progressively better SNR. At some point, the VGA gain drops sufficiently that the constant VGA noise becomes dominant, resulting in a constant SNR from that point. From the perspective of SNR alone, the maximum input level is reached when the VGA reaches its minimum gain.

Distortion must also be considered when maximizing the dynamic range. At low and moderate signal levels, the output distortion is constant and assumed to be adequate for the selected output level. At some point, the input signal becomes large enough that distortion at the input limits the system. The maximum tolerable input signal depends on whether the input distortion becomes unacceptably large or the minimum gain is reached.

The most challenging scenario in terms of dynamic range is the presence of a large out-of-band blocker accompanying a weaker in-band wanted signal. In this case, the maximum input level is dictated by the blocker and its inclination to cause distortion. After filtering, the weak wanted signal must be amplified to the desired output level, possibly requiring maximum gain. Both the distortion limits associated with the blocker at the input and the SNR limits created by the weaker signal and higher gains are present simultaneously. Furthermore, not only does the blocker scenario degrade the dynamic range but it also reduces the range of input signals that can be handled because a larger part of the gain range is used to simply extract the weak desired signal from the stronger blocker.

### KEY PARAMETERS FOR QUADRATURE-BASED RECEIVERS

The majority of digital communication receivers makes use of quadrature signaling, in which bits of information are encoded onto pairs of baseband signals that then modulate in-phase (I)

and quadrature (Q) sinusoidal carriers. Both the baseband and modulated signals appear quite complex in the time domain with dramatic peaks and valleys. In a typical receiver, the goal is to recover the pair of quadrature baseband signals in the presence of noise and interfering signals after quadrature demodulation. In the process of filtering out-of-band noise and unwanted interferers and restoring the levels of the wanted I and Q baseband signals, it is critical to retain their gain and phase integrity over the bandwidth.

The [ADRF6510](#) delivers flat in-band gain and group delay, consistent with a six-pole Butterworth prototype filter as described in the Programmable Filters section. Furthermore, careful design ensures excellent matching of these parameters between the I and Q channels. Although absolute gain flatness and group delay can be corrected with digital equalization, mismatch introduces quadrature errors and intersymbol interference that degrade bit error rates in digital communication systems.



**EVM**

The basic setup to test EVM for the [ADRF6510](#) consisted of an Agilent E4438C used as a RF signal source with an Agilent InfiniiVision DSO7104B oscilloscope in conjunction with the Agilent 89600 VSA software to sample the signal and compute the EVM. The E4438C RF output drove the RF port of the ADL5380 IQ demodulator, which in turn drove the baseband differential inputs of the [ADRF6510](#).

The I and Q outputs of the [ADRF6510](#) were taken differentially into two [AD8130](#) difference amplifiers to convert them into single-ended signals. The single-ended signals were connected to the input channels of the oscilloscope, which captured the modulated waveforms.

An overall baseband EVM performance was measured on the [ADRF6510](#). A modulation setting of 4 QAM and, unless otherwise noted, a 5 MHz symbol rate were used, with a pulse shaping filter alpha of 0.35. The analog gain of the [ADRF6510](#) was adjusted to maintain 1.5 V p-p into a 1 kΩ differential load impedance. Figure 50 shows EVM vs. input power for three different IF frequencies. The input power is the integrated input power over the bandwidth of the modulated signal.

In Figure 50, the [ADRF6510](#) shows excellent EVM of better than -35 dB over a 50 dB range at a 0Hz IF. The user can chose to use a complex IF of 5 MHz to achieve even a better EVM of at least -40 dB over a 50 dB range.

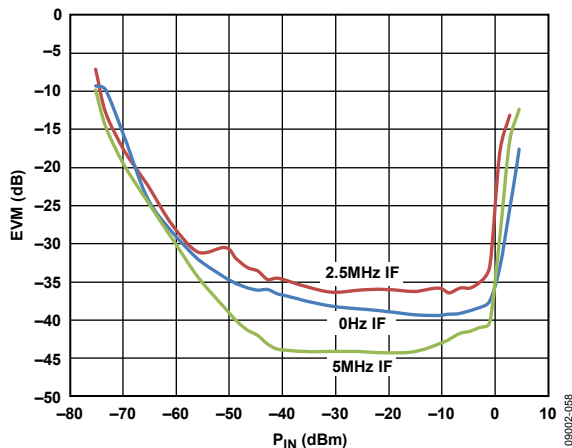

Figure 50. EVM vs. RF Input Power Level; OFDS Pulled Low, C<sub>OFS</sub> = 1 μF

**EFFECT OF FILTER BANDWIDTH ON EVM**

Care should be taken when selecting the filter bandwidth. In a digital transceiver, the modulated signal is filtered by a pulse shaping filter (such as a root-raised cosine filter) at both the transmit and receive ends to guard against intersymbol interference (ISI). If additional filtering of the modulated signal is done, the signal must be within the pass band of the filter. When the corner frequency of the [ADRF6510](#) filter begins to encroach on the modulated signal, ISI is introduced and degrades EVM, which can lead to loss of signal lock.

While low-pass filtering with the [ADRF6510](#) to reject out-of-band undesired signals (blockers), more rejection of the undesired signals may be required. If the filter bandwidth is set to approximately the same as the signal bandwidth, the user may trade some degradation of EVM for a gain in rejection of the out-of-band undesired signals, by lowering the low-pass filter bandwidth corner (for example, by 1 MHz).

Lowering the filter bandwidth to gain more rejection works progressively better the lower the signal and filter bandwidths are set to (see Figure 43). A 1 MHz change from 3 MHz filter bandwidth to 2 MHz filter bandwidth yields about 20 dB more rejection. Compare that to a 1 MHz change from 29 MHz filter bandwidth to 28 MHz filter bandwidth, which will yield about 1 dB more in rejection.

Figure 51 shows that degradation of EVM as signal bandwidth (positive frequency only) is swept while keeping the filter bandwidth set to 5 MHz. Three different C<sub>OFS</sub> capacitor values were used.

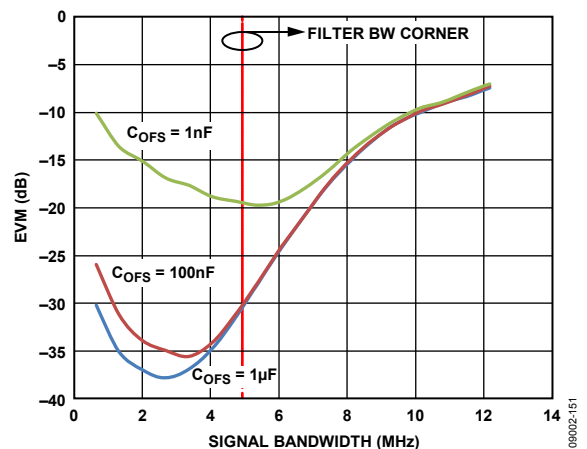

Figure 51. EVM vs. Signal Bandwidth over C<sub>OFS</sub> Values While Maintaining a Filter Bandwidth of 5 MHz

**EFFECT OF OUTPUT VOLTAGE LEVELS ON EVM**

Output voltage level can affect EVM greatly when the signal is compressed. When changing the output voltage levels of the [ADRF6510](#), take care that the output signal is not in compression, which causes EVM degradation.

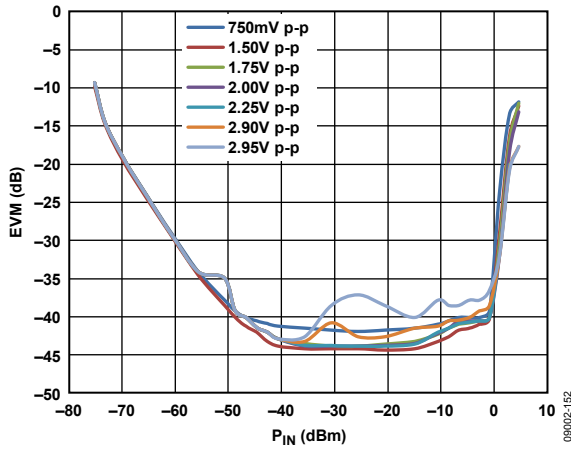

Figure 52. EVM vs. RF Input Power over Output Voltage Levels, IF = 5 MHz, OFDS Pulled High

Figure 52 shows EVM degradation as the signal level nears compression. At 2.25 V p-p the signal is already degraded a few decibels. When the output level is near the absolute limits of the output stage, the EVM becomes much more erratic over the RF input power level.

**EFFECT OF C<sub>OFS</sub> ON EVM**

When enabled, the dc offset compensation loop effectively nulls any information below the high-pass corner set by the C<sub>OFS</sub> capacitor. However, loss of the low frequency information of the modulated signal can degrade the EVM in some cases.

As the signal bandwidth becomes larger, the percentage of information that is corrupted by the high-pass corner becomes smaller. In such cases, it is important to select a C<sub>OFS</sub> capacitor large enough to minimize the high-pass corner frequency, which prevents loss of information and degraded EVM.

Figure 53 shows the effect of C<sub>OFS</sub> values at a single signal bandwidth of 6.75 MHz = 1.35 × 5 MHz over input power.

Figure 54 shows that EVM can be improved by using a bigger C<sub>OFS</sub> value and/or increasing the signal bandwidth. Increasing signal bandwidth will improve EVM to a point after which the bandwidth limitations of the source, the part, and/or the receiver will start to dominate and degrade EVM.

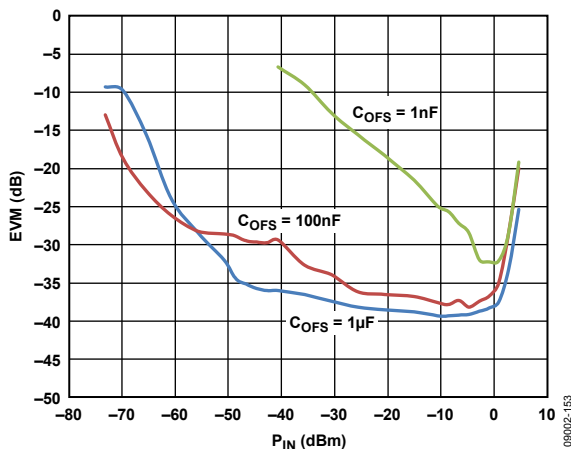

Figure 53. EVM vs. RF Input Power over C<sub>OFS</sub> Values

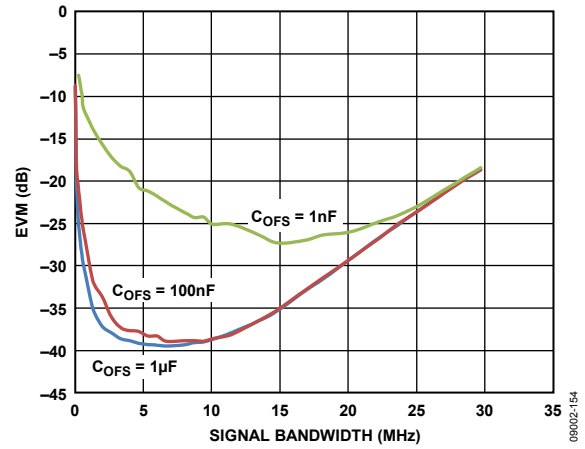

Figure 54. EVM vs. Signal BW over C<sub>OFS</sub> Values

**ANTI-ALIASING FILTER**

The noise spectral density of the ADRF6510 outside the filter bandwidth is limited by the fixed VGA output noise. It may be necessary to use an external, fixed-frequency, passive filter prior to an analog-to-digital conversion to prevent noise aliasing from degrading the signal-to-noise ratio. As shown in Figure 47 and Figure 48, the noise density at higher frequencies tends to be flat, and any higher IF noise aliasing into the Nyquist zone has minimal effects.

When designing an antialiasing filter, it is necessary to consider the overall source and load impedance presented by the ADRF6510 and the ADC input to design the filter network. The differential baseband output impedance of the ADRF6510 is 20 Ω and is designed to drive a high impedance ADC input. It may be desirable to terminate the ADC input to a lower impedance by using a terminating resistor, such as 500 Ω. The terminating resistor helps to better define the input impedance at the ADC input at the cost of a slightly reduced gain.

The order and type of filter network depend on the desired high frequency rejection required, the pass-band ripple, and the group delay. Filter design tables provide outlines for various filter types and orders, illustrating the normalized inductor and capacitor values for a 1 Hz cutoff frequency and 1 Ω load.

After scaling the normalized prototype element values by the actual desired cutoff frequency and load impedance, the series reactance elements are halved to realize the final balanced filter network component values.

As an example, a second-order Butterworth, low-pass filter design is shown in Figure 55 where the differential load impedance is 500 Ω and the source impedance is 50 Ω. The normalized series inductor value for the 10-to-1, load-to-source impedance ratio is 0.074 H, and the normalized shunt capacitor is 14.814 F. For a 31 MHz cutoff frequency, the single-ended equivalent circuit consists of a 0.191 µH series inductor followed by a 152 pF shunt capacitor.

The balanced configuration is realized as the  $0.191 \mu\text{H}$  inductor is split in half to achieve the network that is shown in Figure 55.

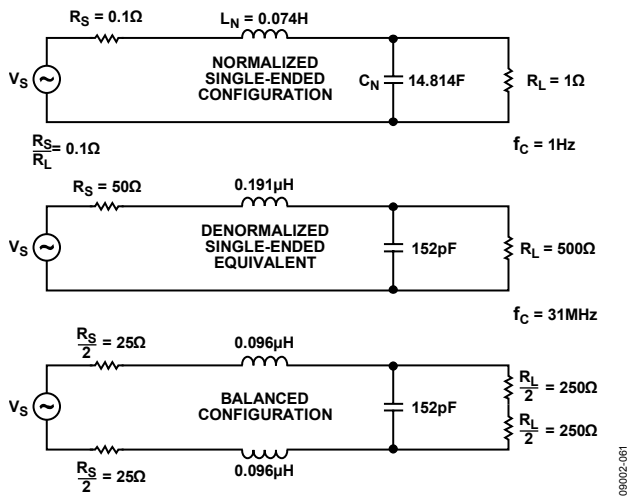

Figure 55. Second-Order Butterworth, Low-Pass Filter Design Example

A complete design example is shown in Figure 56. A third-order Chebyshev differential filter with a 31 MHz corner frequency interfaces the output of the ADRF6510 to that of an ADC input. The  $20 \Omega$  source impedance reflects the impedance of the output buffer stage. The  $500 \Omega$  load resistor defines the input impedance of the ADC. The filter adheres to a 0.1 dB in-band flatness and offers sufficient out-of-band rejection to act as an antialiasing filter.

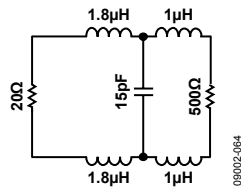

Figure 56. Third-Order Chebyshev Differential Filter Design Example

Figure 57 and Figure 58 show the measured frequency response and group delay of the third-order Chebyshev differential filter.

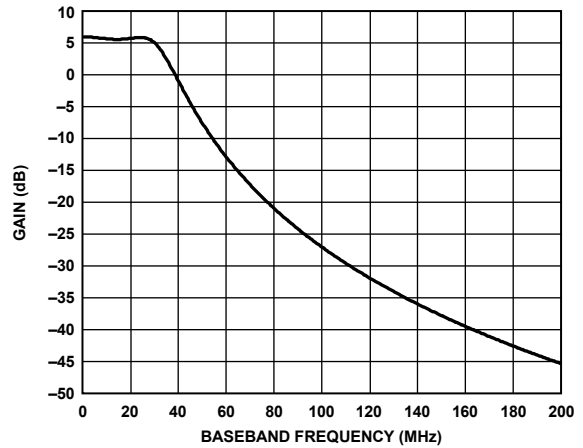

Figure 57. Third-Order Baseband Filter Response

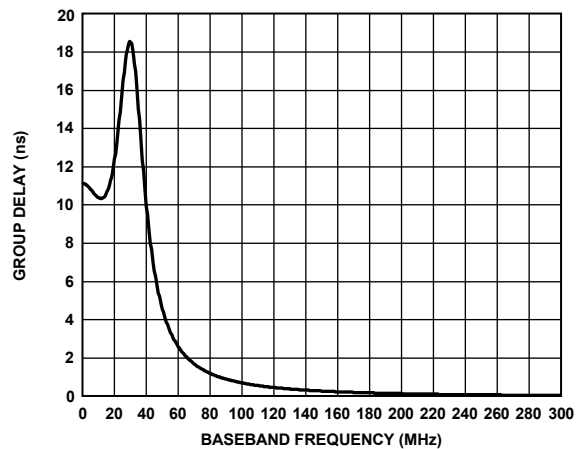

Figure 58. Third-Order Baseband Filter Group Delay Response

## EVALUATION BOARD

The **ADRF6510** evaluation board is available with software control to program the filter bandwidth. It is a 4-layer board with split ground plane for analog and digital sections. Special care is taken to place the power decoupling capacitors close to the device pins. The board is designed for easy single-ended (through a Mini-Circuits® ADT8-1T+ 8:1 balun) or differential configuration for each channel.

## EVALUATION BOARD CONTROL SOFTWARE

The **ADRF6510** evaluation board is configured with a USB-friendly interface to program the filter bandwidth of the **ADRF6510**. The software GUI (see Figure 59) allows users to select a particular frequency to write to the device and also to read back data from the SDO pin that shows the currently programmed filter setting. The software setup files can be downloaded from the **ADRF6510** product page at [www.analog.com](http://www.analog.com).

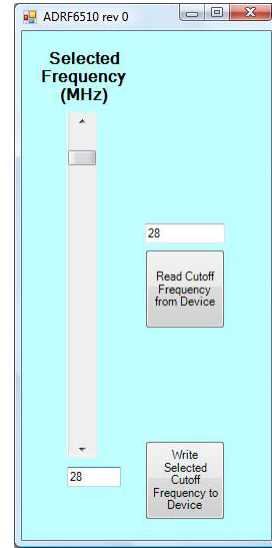

Figure 59. Evaluation Control Software

## SCHEMATICS AND ARTWORK

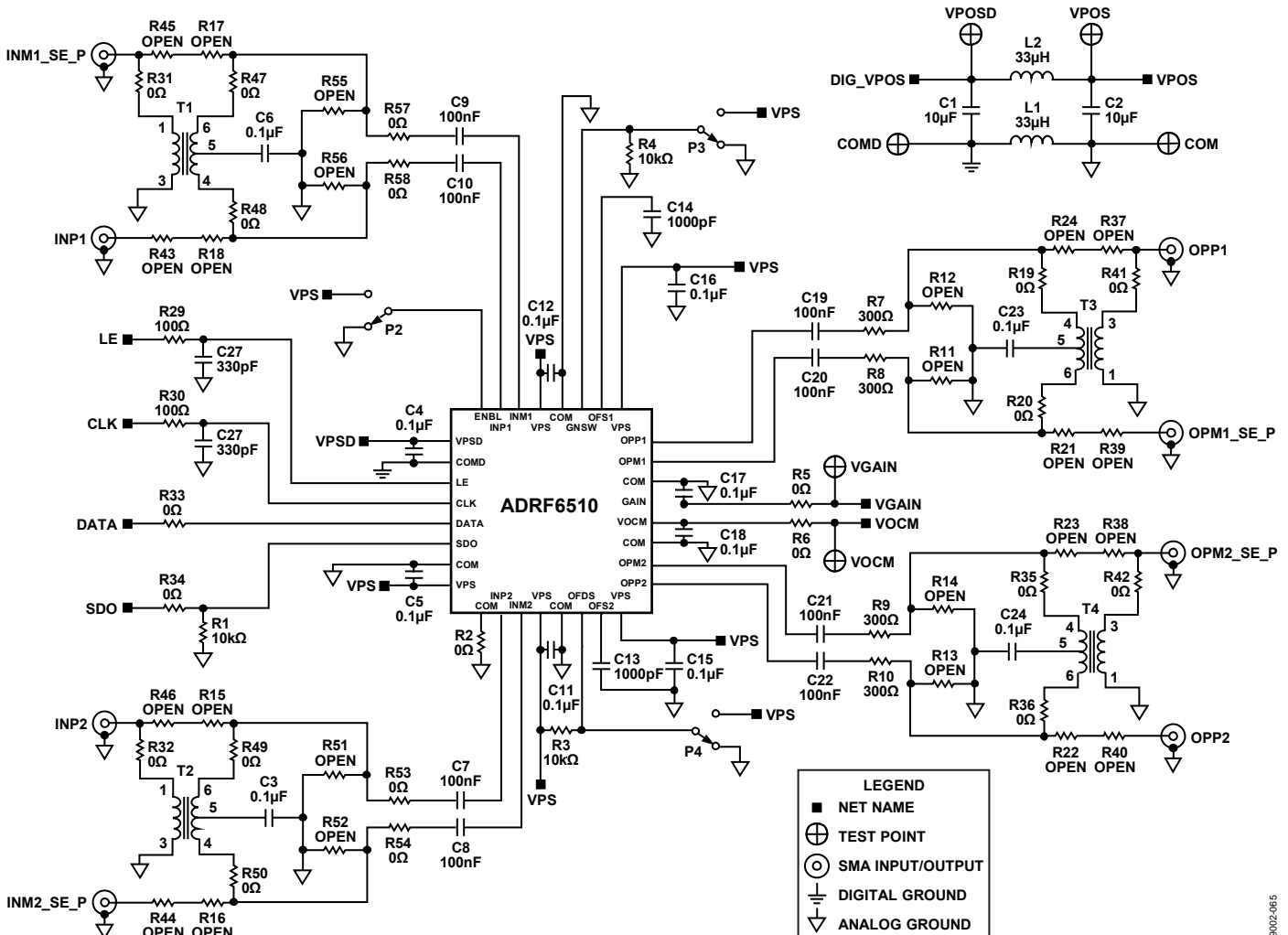

Figure 60. Evaluation Board Schematic



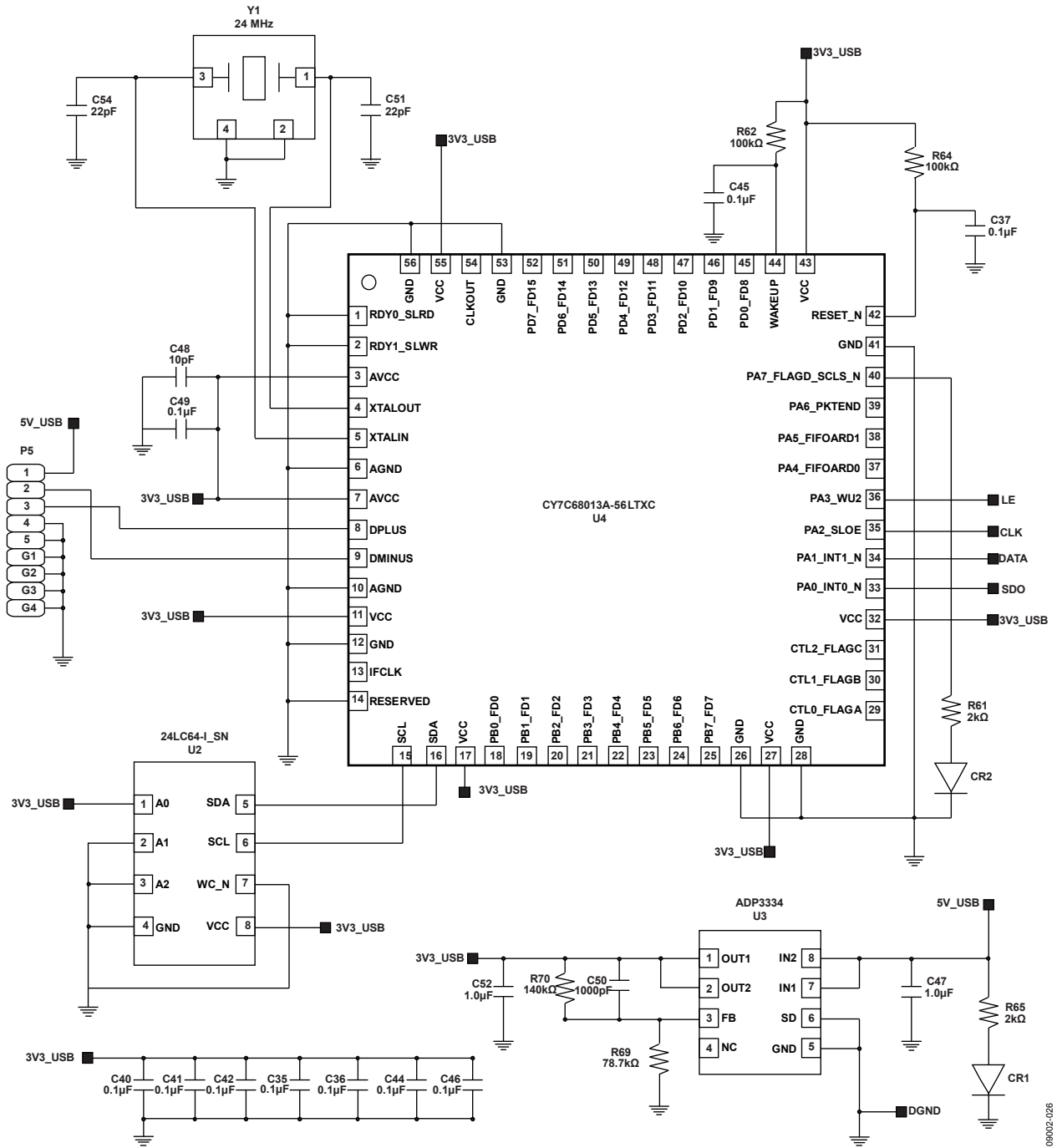
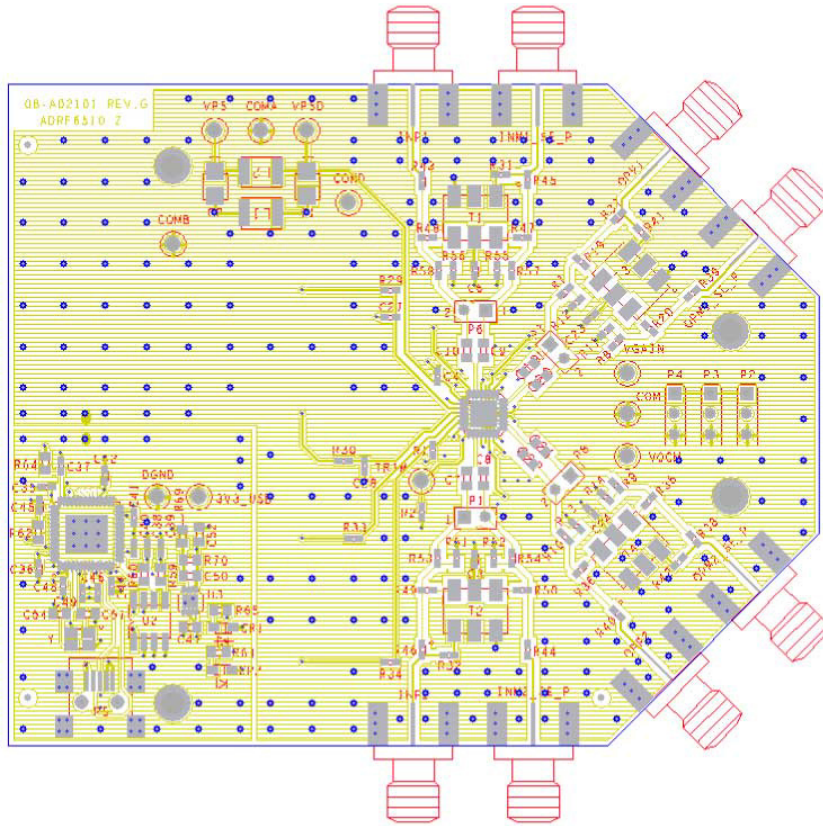

Figure 61. Schematic for the USB Section of the Evaluation Board

09002-026



09002-052

Figure 62. Top Layer Silkscreen

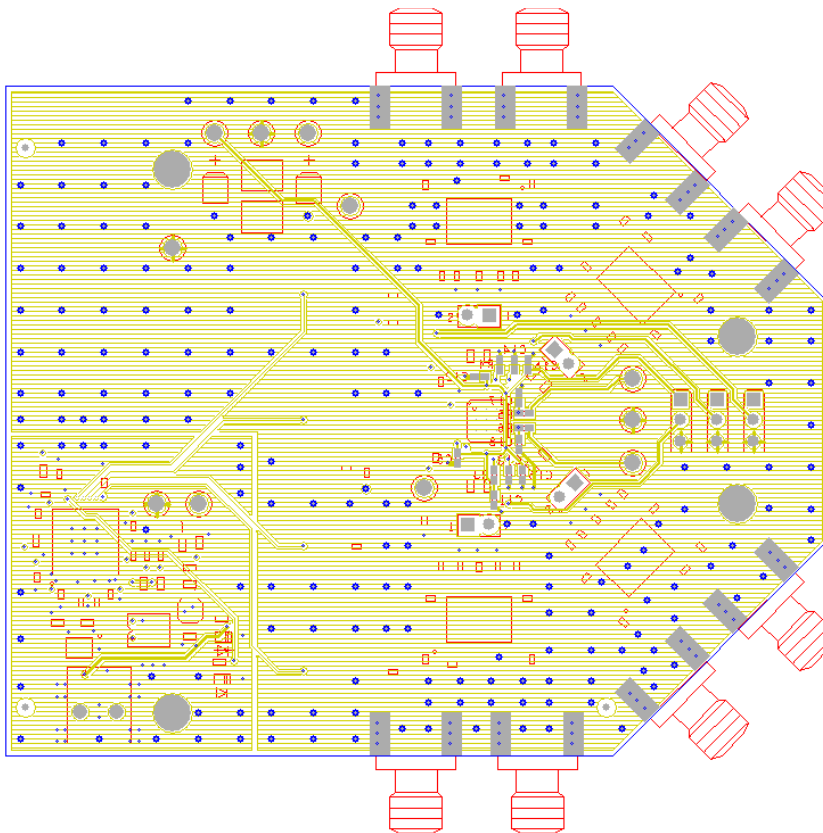

09002-053

Figure 63. Component Side Layout

## EVALUATION BOARD CONFIGURATION OPTIONS

Table 5 lists the components of the main section of the ADRF6510 evaluation board.

Table 5.

Components	Function	Default Conditions
C1, C2, C4, C5, C11, C12, C15, C16, L1, L2	Power supply and ground decoupling. Nominal supply decoupling consists of a 0.1 $\mu\text{F}$ capacitor to ground.	C1, C2 = 10 $\mu\text{F}$ (Size 1210) C4, C5, C11, C12, C15, C16 = 0.1 $\mu\text{F}$ (Size 0603) L1, L2 = 33 $\mu\text{H}$ (Size 1812) R2 = 0 $\Omega$ (Size 0402)
T1, T2, C3, C6, C7 to C10, R15 to R18, R31, R32, R43 to R58	Input interface. Input SMAs INM1_SE_P and INP2_SE_P are used to drive the baluns in a single-ended fashion. The default configuration of the evaluation board is for single-ended operation. T1 and T2 are 8:1 impedance ratio baluns to transform a 50 $\Omega$ , single-ended input into a 400 $\Omega$ balanced differential signal. R31, R32, and R47 to R50 are populated for appropriate balun interface. R51 to R58 are provided for generic placement of matching components. C3 and C6 are balun decoupling capacitors. R15 to R18 and R43 to R46 can be populated with 0 $\Omega$ , and the balun interfacing resistors can be removed to bypass T1 and T2 for differential interfacing. C7 to C10 can be used for ac coupling with differential interfacing.	T1, T2 = ADT8-1T+ (Mini-Circuits) C3, C6 = 0.1 $\mu\text{F}$ (Size 0402) C7 to C10 = 100 nF (Size 0402) R15 to R18, R43 to R46, R51, R52, R55, R56 = open (Size 0402) R31, R32, R47 to R50, R53, R54, R57, R58 = 0 $\Omega$ (Size 0402)
T3, T4, C19 to C24, R7 to R14, R19 to R24, R35 to R42	Output interface. Output SMAs OPP1_SE_P and OPM2_SE_P are used to drive the baluns in a single-ended fashion. The default configuration of the evaluation board is for single-ended operation. T3 and T4 are 8:1 impedance ratio baluns to transform a 50 $\Omega$ , single-ended output into a 400 $\Omega$ balanced differential load. R19, R20, R35, R36, R41, and R42 are populated for appropriate balun interface. R7 to R14 are provided for generic placement of matching components. R7 to R10 are set to 300 $\Omega$ to present a 1 k $\Omega$ load (with the balun used) at the DUT output. C19 to C22 are used for ac coupling when differential outputs are used. C23 and C24 are balun decoupling capacitors. R21 to R24 and R37 to R40 can be populated with 0 $\Omega$ , and the balun interfacing resistors can be removed to bypass T3 and T4 for differential interfacing.	T3, T4 = ADT8-1T+ (Mini-Circuits) C19 to C22 = 100 nF (Size 0402) C23, C24 = 0.1 $\mu\text{F}$ (Size 0402) R7 to R10 = 300 $\Omega$ (Size 0402) R11 to R14 = open R19, R20, R35, R36, R41, R42 = 0 $\Omega$ (Size 0402) R21 to R24, R37 to R40 = open (Size 0402)
P2	Enable interface. The ADRF6510 is powered up by applying a logic high voltage to the ENBL pin (Jumper P2 is connected to VPS).	P2 = installed for enable
C27, C28, R1, R29, R30, R33, R34	Serial interface control. The digital interface sets the corner frequency of the device using the serial interface via the LE, CLK, DATA, and SDO pins.	R1 = 10 k $\Omega$ (Size 0402) C27, C28 = 330 pF (Size 0402) R29, R30 = 100 $\Omega$ (Size 0402) R33, R34 = 0 $\Omega$ (Size 0402)
P4, C13, C14, R3	DC offset correction loop compensation. The dc offset correction loop is enabled (low) with Jumper P4. When enabled, the capacitors are connected to circuit common. The high-pass corner frequency is expressed as follows: $f_{HP} \text{ (Hz)} = 1.2 \times ((\text{Linear Gain})/C_{OFS} \text{ (}\mu\text{F)})$ .	P4 = installed C13, C14 = 1000 pF (Size 0402) R3 = 10 k $\Omega$ (Size 0402)
C18, R6	Output common-mode setpoint. The output common-mode voltage can be set externally when applied to the VOVM pin. If the VOVM pin is left open, the output common-mode voltage defaults to VPS/2.	C18 = 0.1 $\mu\text{F}$ (Size 0402) R6 = 0 $\Omega$ (Size 0402)
C17, R5	Analog gain control. 0 V to 2 V, 30 mV/dB gain scaling.	C17 = 0.1 $\mu\text{F}$ (Size 0402) R5 = 0 $\Omega$ (Size 0402)
P3, R4	Front-end 6 dB or 12 dB gain switch. Pull low for 6 dB; pull high for 12 dB.	P3 = installed R4 = 10 k $\Omega$ (Size 0402)

**USB Section Configuration Options**

Table 6 lists the components of the USB section of the [ADRF6510](#) evaluation board.

**Table 6.**

<b>Components</b>	<b>Default Conditions</b>
XC1, XC2, XC6	22 pF (Size 0603)
XC3 to XC5, XC7, XC8, XC12 to XC19	0.1 $\mu$ F (Size 0402)
XC9 to XC11	10 pF (Size 0402)
XD1	Green LED ( Panasonic LNJ308G8TRA)
XJ1	USB SMT connector (Hirose Electric UX60A-MB-5ST 240-0003-4)
XR1, XR2	2 k $\Omega$ (Size 0603)
XR3	1 k $\Omega$ (Size 0603)
XR4, XR5	100 k $\Omega$ (Size 0603)
XR6	0 $\Omega$ (Size 0603)
XU1	USB microcontroller (Cypress CY7C68013A-56LFXC)
XU2	64 kb EEPROM (Microchip 24LC64-I/SN)
XU3	Low dropout regulator (Analog Devices ADP3303ARZ-3.3)
XY1	24 MHz crystal oscillator (AEL Crystals X24M000000S244)

# OUTLINE DIMENSIONS

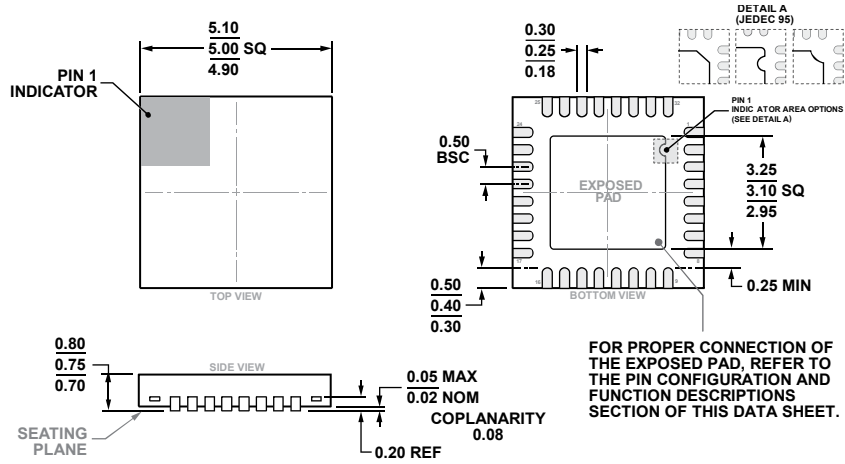

COMPLIANT TO JEDEC STANDARDS MO-220-WHHD

Figure 64. 32-Lead Lead Frame Chip Scale Package [LFCSP]  
5 mm × 5 mm Body and 0.75 mm Package Height  
(CP-32-7)  
Dimensions shown in millimeters

## ORDERING GUIDE

Model <sup>1</sup>	Temperature Range	Package Description	Package Option
ADRF6510ACPZ-R7	-40°C to +85°C	32-Lead LFCSP, 7" Tape and Reel	CP-32-7
ADRF6510-EVALZ		Evaluation Board	

<sup>1</sup> Z = RoHS Compliant Part.

**NOTES**

**NOTES**

**NOTES**





Компания «ЭлектроПласт» предлагает заключение долгосрочных отношений при поставках импортных электронных компонентов на взаимовыгодных условиях!

Наши преимущества:

- Оперативные поставки широкого спектра электронных компонентов отечественного и импортного производства напрямую от производителей и с крупнейших мировых складов;
- Поставка более 17-ти миллионов наименований электронных компонентов;
- Поставка сложных, дефицитных, либо снятых с производства позиций;
- Оперативные сроки поставки под заказ (от 5 рабочих дней);
- Экспресс доставка в любую точку России;
- Техническая поддержка проекта, помощь в подборе аналогов, поставка прототипов;
- Система менеджмента качества сертифицирована по Международному стандарту ISO 9001;
- Лицензия ФСБ на осуществление работ с использованием сведений, составляющих государственную тайну;
- Поставка специализированных компонентов (Xilinx, Altera, Analog Devices, Intersil, Interpoint, Microsemi, Aeroflex, Peregrine, Syfer, Eurofarad, Texas Instrument, Miteq, Cobham, E2V, MA-COM, Hittite, Mini-Circuits, General Dynamics и др.);

Помимо этого, одним из направлений компании «ЭлектроПласт» является направление «Источники питания». Мы предлагаем Вам помощь Конструкторского отдела:

- Подбор оптимального решения, техническое обоснование при выборе компонента;
- Подбор аналогов;
- Консультации по применению компонента;
- Поставка образцов и прототипов;
- Техническая поддержка проекта;
- Защита от снятия компонента с производства.



#### Как с нами связаться

**Телефон:** 8 (812) 309 58 32 (многоканальный)

**Факс:** 8 (812) 320-02-42

**Электронная почта:** [org@eplast1.ru](mailto:org@eplast1.ru)

**Адрес:** 198099, г. Санкт-Петербург, ул. Калинина, дом 2, корпус 4, литера А.