

# General Specifications

## Electrical Capacity (Resistive Load)

**Power Level (silver):** 3A @ 125V AC or 3A @ 250V AC or 3A @ 30V DC  
**Logic Level (gold):** 0.4VA maximum @ 28V AC/DC maximum  
 (Applicable Range 0.1mA ~ 0.1A @ 20mV ~ 28V)  
 Note: Find additional explanation of operating range in Supplement section.

## Other Ratings

**Contact Resistance:** 50 milliohms maximum for silver; 100 milliohms maximum for gold  
**Insulation Resistance:** 200 megohms minimum @ 500V DC  
**Dielectric Strength:** 1,000V AC minimum between contacts for 1 minute minimum;  
 1,500V AC minimum between contacts & case for 1 minute minimum  
**Mechanical Life:** 1,000,000 operations minimum for momentary circuit  
 200,000 operations minimum for maintained circuit  
**Electrical Life:** 100,000 operations minimum  
**Nominal Operating Force:** 4.41N  
**Contact Timing:** Nonshorting (break-before-make)  
**Travel:** Pretravel .059" (1.5mm); Overtravel .059" (1.5mm); Total Travel .118" (3.0mm)

## Materials & Finishes

**Housing:** Glass fiber reinforced polyamide (UL94V-0)  
**Snap-in Frame:** Stainless steel  
**Movable Contact:** Silver alloy or copper with gold plating  
**Stationary Contacts:** Silver alloy or copper with gold plating  
**Base:** Liquid crystal polymer (UL94V-0)  
**Switch Terminals:** Phosphor bronze with silver or gold plating  
**Lamp Terminals:** Brass with silver plating

## Environmental Data

**Operating Temperature Range:** -25°C through +50°C (-13°F through +122°F) for Illuminated  
 -25°C through +70°C (-13°F through +158°F) for Nonilluminated  
 Note: When used with a polyvinyl chloride splash cover, the lowest limit is 0°C (32°F)  
**Humidity:** 90 ~ 95% humidity for 96 hours @ 40°C (104°F)  
**Vibration:** 10 ~ 55Hz with peak-to-peak amplitude of 1.5mm traversing the frequency range & returning in 1 minute; 3 right angled directions for 2 hours  
**Shock:** 50G (490m/s<sup>2</sup>) acceleration (tested in 6 right angled directions, with 5 shocks in each direction)  
**Sealing:** Not available for snap-in; see next section for panel seal.

## Installation

**Cap Installation Force:** 3.92N maximum downward force on cap  
**Quick Connect Force:** 52.95N maximum downward force on connector  
**Soldering Time & Temperature:** Manual Soldering: See Profile A in Supplement section.

## Standards & Certifications

**Flammability Standards:** UL94V-0 housing & base  
**UL:** **File No. E44145 - Recognized only when ordered with marking on switch.**  
 Add "/U" or "/CUL" before first dash in part number to order UL recognized switch.  
 All models recognized at 3A @ 125V or 250V AC or 0.4VA @ 28V AC/DC maximum.  
**CSA:** **File No. 023535\_0\_000 - Certified only when ordered with marking on switch.**  
 Add "/C" before first dash in part number to order CSA certified switch.  
 All models certified at 3A @ 125V or 250V AC or 0.4VA @ 28V AC/DC maximum.

# Distinctive Characteristics

Carefully designed light diffusion and filtering system produces bright, full surface illumination with front panel relamping.

Spot illumination available in single and bicolor LEDs.

Choice of super bright LEDs in white, green, and blue in addition to standard or bright red, amber, and green LEDs.

Stainless steel clips provide secure mounting with a wide range of panel thicknesses.

Latchdown feature gives indication of circuit status. Audible and tactile feedback with smooth and responsive operation.

Snap-action contact mechanism gives long electrical life and sensitivity of actuation.

Combination solder lug and .110" quick connect terminals are epoxy sealed to prevent entry of flux, dust, and other contaminants.

Panel sealed model meets IP65 of IEC60529 specifications (similar to NEMA 4 & 13).

Compact switch design minimizes behind panel depth.

Matching indicators available.



Actual Size



- Toggle
- Rockers
- Pushbuttons
- D Illuminated PB**
- Programmable
- Keylocks
- Rotaries
- Slides
- Tactiles
- Tilt
- Touch
- Indicators
- Accessories
- Supplement

## TYPICAL SWITCH ORDERING EXAMPLE



### IMPORTANT:



Switches are supplied without UL, cULus & CSA marking unless specified. **UL, cULus & CSA recognized only when ordered with marking on the switch.** Specific models, ratings, & ordering instructions are noted on General Specifications page.

\* Wire harness & cable assemblies offered only in Americas

### DESCRIPTION FOR TYPICAL ORDERING EXAMPLE

**LB15SKW01-5C12-JC**



Lamps				Cap Types & Colors			
<b>Incandescent Lamp Used with Solid Cap</b>				<b>Solid Cap: Lens/Filter Colors</b>			
05	5-volt	BJ	White/Clear				
12	12-volt	CJ	Red/Clear				
No Code	Nonilluminated	EJ	Yellow/Clear				
				<b>Insert Cap: Lens/Filter Colors</b>			
<b>Incandescent or Neon Used with Insert Cap</b>							
01	110-volt Neon	JB	Clear/White				
05	5-volt Incandescent	JC	Clear/Red				
12	12-volt Incandescent	JE	Clear/Yellow				
No Code	Nonilluminated	*JF	Clear/Green				
				*JF & JG not suitable with neon.			
				<b>LED Cap: Lens/Diffuser Colors</b>			
<b>Bright LED Used with LED Cap</b>							
<b>Colors</b>		<b>Resistor</b>					
5C	Red	No Code	No Resistor				
5D	Amber	05	5-volt				
5F	Green	12	12-volt				
		24	24-volt				
				<b>LED Cap: Lens/Diffuser Colors</b>			
<b>Super Bright LED Used with LED Cap</b>							
6B	White	JB		Clear/White			
6F	Green	JC		Clear/Red			
6G	Blue	JD		Clear/Amber			
				JF		Clear/Green	
				<b>Spot Illuminated Cap Colors</b>			
<b>LED in Spot Illuminated Cap</b>							
1C	Red Single Color			A	Black	Available in Square and Round only.	
1D	Amber Single Color			B	White		
1F	Green Single Color			C	Red		
CF	Red/Green Bicolor			F	Green		
<b>Nonilluminated</b>				<b>Nonilluminated Cap Colors</b>			
No Code	Nonilluminated			A	Black	F	Green
				B	White	G	Blue
				C	Red	H	Gray
				E	Yellow		

Toggles

Rockers

Pushbuttons

Illuminated PB

Programmable

Keylocks

Rotaries

Slides

Tactiles

Tilt

Touch

Indicators

Accessories

Supplement

## POLES & CIRCUITS

		Plunger Position ( ) = Momentary		Connected Terminals		Throw & Switch/Lamp Schematics
Pole	Model	Normal	Down	Normal	Down	Notes: Switch is marked with NC, NO, COM, L+, L-. Lamp circuit is isolated and requires an external power source.
SP	<b>LB15</b> <b>*LB16</b>	ON ON	(ON) ON	1-3	1-2	SPDT 
DP	<b>LB25</b> <b>*LB26</b>	ON ON	(ON) ON	1-3 4-6	1-2 4-5	DPDT 

\* When in latchdown position for the alternate circuit, cap position is .039" (1.0mm) above the built-in bezel.

## SHAPES & PANEL CUTOUTS

**S** .622" (15.8mm)  
Square



Cutout for 1 switch:  
.638" x .638" (16.2mm x 16.2mm)  
Cutout for 1 switch with barriers:  
.638" x .815" (16.2mm x 20.7mm)

**C** .854" (21.7mm)  
Round



**R** .622" x .866" (15.8mm x 22.0mm)  
Rectangular



Cutout for 1 switch:  
.638" x .882" (16.2mm x 22.4mm)  
Cutout for 1 switch with barriers:  
.638" x 1.059" (16.2mm x 26.9mm)

Panel Thickness for Switches & Barriers: .039" ~ .157" (1.0 ~ 4.0mm)  
Panel Thickness for Protective Guards & Splash Covers: .039" ~ .138" (1.0 ~ 3.5mm)

## HOUSING

Housing Colors Available:

**K** Black

**G** Gray

## CONTACT MATERIALS, RATINGS & TERMINALS

**W01**

Silver Contacts

Power Level  
3A @ 125V AC & 250V AC

**G01**

Gold Contacts

Logic Level  
0.4VA max. @ 28V AC/DC max.

Solder Lug/Quick Connect

Optional PCB adaptors  
AT711 & AT712 available;  
illustrated in "Optional  
Accessories" immediately following  
"Typical Switch Dimensions."



Complete explanation of operating range in Supplement section.

## INCANDESCENT & NEON LAMP CODES & SPECIFICATIONS

**AT607 & AT607N**



T-1 Bi-pin

		<b>05</b>	<b>12</b>	<b>01</b> *
	AT607 Incandescent 5-volt or 12-volt; AT607N Neon 110-volt			
Voltage	V	5V AC	12V AC	110V AC
Current	I	115mA	60mA	1.5mA
Endurance	Avg. Hours	10,000		10,000
Ambient Temp. Range		-25°C ~ +50°C		

The electrical specifications shown are determined at a basic temperature of 25°C. Lamp circuit is isolated and requires external power source.

\* Recommended Resistors for Neon:  
33K ohms for 110V AC;  
100K ohms for 220V AC

## LED COLORS & SPECIFICATIONS

The electrical specifications shown are determined at a basic temperature of 25°C.  
 LED circuit is isolated and requires external power source. Polarity marks are on the switch.  
 If the source voltage exceeds the rated voltage, a ballast resistor is required.  
 The resistor value can be calculated by using the formula in the Supplement section.  
 Additional lamp detail is shown in the Accessories & Hardware section.

### Bright LED without Resistor

<b>AT635</b>  LEDs are colored in OFF state.      T-1 1/2 Bi-pin	Color Codes	Red <b>5C</b>	Amber <b>5D</b>	Green <b>5F</b>	<b>No Code</b> No Resistor		
	Forward Peak Current	$I_{FM}$			Red	Amber	Green
	Typical Forward Current	$I_F$			30mA	30mA	30mA
	Forward Voltage	$V_F$			1.9V	2.0V	2.1V
	Reverse Peak Voltage	$V_{RM}$			5V	5V	5V
	Current Reduction Rate Above 25°C	$\Delta I_F$			0.42mA/°C		
	Ambient Temperature Range				-25° ~ +50°C		

### Bright LED with Resistor

<b>AT627 with Resistor</b>    T-1 Bi-pin	Color Codes:	Red <b>5C</b>	Amber <b>5D</b>	Green <b>5F</b>	Resistor Codes		
	Forward Peak Current	$I_{FM}$			<b>05</b>	<b>12</b>	<b>24</b>
	Typical Forward Current	$I_F$			52mA	26mA	13mA
	Forward Voltage	$V_F$			5V	12V	24V
	Reverse Peak Voltage	$V_{RM}$			4V	8V	16V
	Current Reduction Rate Above 25°C	$\Delta I_F$			0.50mA/°C		
	Ambient Temperature Range				-25° ~ +50°C		

AT627  
5-volt  
4-element  
with Resistor



AT627  
12-volt  
4-element  
with Resistor



AT627  
24-volt  
4-element  
with Resistor



### Super Bright Single Element LED

<b>AT625G Blue</b> <b>AT631B White</b> <b>AT632F Green</b>      T-1 Bi-pin				<b>6B</b>	<b>6F</b>	<b>6G</b>	
	Color	White	Green	Blue			
	Forward Peak Current	$I_{FM}$			30mA	30mA	30mA
	Typical Forward Current	$I_F$			20mA	20mA	20mA
	Forward Voltage	$V_F$			3.6V	3.5V	3.6V
	Reverse Peak Voltage	$V_{RM}$			5V	5V	5V
	Current Reduction Rate Above 25°C	$\Delta I_F$			0.50mA/°C		
	Ambient Temperature Range				-25° ~ +50°C		

**No Code**

No Lamp

## CAP TYPES & COLOR COMBINATIONS

Color Codes: B White C Red D Amber E Yellow F Green G Blue J Clear

### Solid Cap for Incandescent Lamp & Nonilluminated

Lens/Filter  
Colors Available:



**AT476**  
Square



**AT4012**  
Round



**AT4026**  
Rectangular



Material: Polycarbonate Finish: Glossy

### Insert Cap for Incandescent or Neon Lamp & Nonilluminated

Lens/Filter  
Colors Available:



**AT477**  
Square



**AT4013**  
Round



**AT4027**  
Rectangular



JF and JG not suitable with neon lamp.

Material: Polycarbonate Finish: Glossy

### Cap for Bright LED without Resistor

Lens/Diffuser  
Colors Available:



**AT4176**  
Square



**AT4178**  
Round



**AT4177**  
Rectangular



Material: Polycarbonate Finish: Glossy

### Cap for Bright LED with Resistor

Lens/Diffuser  
Colors Available:



**AT4162**  
Square



**AT4164**  
Round



**AT4163**  
Rectangular



Material: Polycarbonate Finish: Glossy



## CAP TYPES & COLOR COMBINATIONS

Color Codes: A Black B White C Red D Amber E Yellow F Green G Blue H Gray J Clear

### Cap for Super Bright LEDs

**JB**

Clear Lens  
White Diffuser

**AT4129**  
Square

**AT4128**  
Round

**AT4130**  
Rectangular



Transparent  
Clear Lens

Material:  
Polycarbonate  
Finish: Glossy



Translucent  
White Diffuser



LEDs AT625  
AT631 AT632

### Spot Illuminated Cap with LED

The electrical specifications shown are determined at a basic temperature of 25°C. LED circuit is isolated and requires an external power source. Single color LEDs are colored in OFF state; bicolor LEDs are translucent white in OFF state. Polarity marks are on the switch. If the source voltage exceeds the rated voltage, a ballast resistor is required. The resistor value can be calculated by using the formula in the Supplement section. Additional lamp detail is shown in the Accessories & Hardware section.

### LED Specifications

LED factory assembled in Spot Illuminated Caps	Single Color LED with 1 Element 	Bicolor LED with 2 Elements 	Single Color			Bicolor
			<b>1C</b> Red	<b>1D</b> Amber	<b>1F</b> Green	<b>CF</b> Red/Green
Not Available Separately	Forward Peak Current	$I_{FM}$	10mA	30mA	30mA	30/25mA
	Typical Forward Current	$I_F$	8mA	24mA	24mA	20mA
	Forward Voltage	$V_F$	1.9V	2.0V	2.1V	2.0/2.2V
	Reverse Peak Voltage	$V_{RM}$	5V	5V	5V	—
	Current Reduction Rate Above 25°C	$\Delta I_F$	0.13mA/°C	0.40mA/°C	0.40mA/°C	0.43/0.38mA/°C
	Ambient Temperature Range	-25° ~ +50°C				

Cap Colors Available:



Material:  
Polycarbonate  
Finish: Glossy

**AT480**  
Square



**AT4016**  
Round



Cap with Window



Factory Assembled LED;  
Not Available Separately

When ordering spot illuminated cap separately, LED color must be specified.  
Examples: AT480CA (red LED, black cap); AT4016CFB (red/green bicolored LED, white cap)

### Cap for Nonilluminated

Cap Colors Available:



**AT484**  
Square



**AT4017**  
Round



**AT4030**  
Rectangular



Cap  
No Lamp

Material: Polycarbonate Finish: Glossy

## TYPICAL SWITCH DIMENSIONS

### Square

### Single & Double Pole



**LB15SKW01-12-CJ**

Single pole models do not have terminals 4, 5, & 6.

### Round

### Single & Double Pole

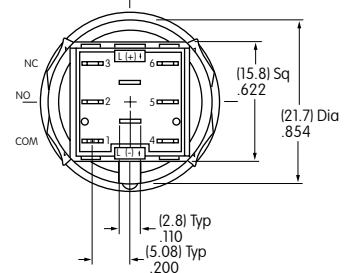

**LB16CKW01-12-CJ**

Single pole models do not have terminals 4, 5, & 6.

### Rectangular

### Single & Double Pole



**LB26RGW01-12-CJ**

Single pole models do not have terminals 4, 5, & 6.

## OPTIONAL ACCESSORIES

### PCB Adaptors

#### AT711 Single Pole • Straight PC Terminals

#### AT712 Double Pole • Straight PC Terminals



Note: Order adaptors separately.



## OPTIONAL ACCESSORIES

### Barriers



Material: Polyamide



### Cutouts for More Than 1 Switch



**Square**  
 $A = .752'' (19.1\text{mm}) \times \text{Number of Switches} + .051'' (1.3\text{mm})$   
**Rectangular**  
 $A = .996'' (25.3\text{mm}) \times \text{Number of Switches} + .051'' (1.3\text{mm})$

### Protective Guard

#### AT499 Square Protective Guard

Opens 90°  
Closes manually



Material: Polyamide

Protective Guards reduce depth of switch behind panel by .020" (0.5mm).

### Spring Loaded Protective Guard

#### AT4171 Square Protective Guard

Opens 180°  
Closes automatically



(N) = Number of switches \* Minimum dimension allows opening of cover to 180°

#### Materials:

Cover: Clear Polycarbonate  
 Base: Black GFR Polyamide  
 Coil Spring: Stainless Steel



**Recommended Panel Thickness:**  
 .039" ~ .106" (1.0mm ~ 2.7mm)

## OPTIONAL ACCESSORIES

### AT4057 Rectangular Protective Guard

Opens 90°  
Closes manually



### Protective Guard



Material: Polyamide

Protective Guards reduce depth of switch behind panel by .020" (0.5mm).

### AT4172 Rectangular Protective Guard



### Spring Loaded Protective Guard



Opens 180°  
Closes automatically

**Materials:**  
Cover: Clear Polycarbonate  
Base: Black GFR Polyamide  
Coil Spring: Stainless Steel

Recommended Panel Thickness:  
.039" ~ .106" (1.0mm ~ 2.7mm)



(N) = Number of switches \* Minimum dimension allows opening of cover to 180°

### Dust Covers

### AT4002 Round



### AT4001 Square



### AT4011 Rectangular



Materials: PVC with polyethylene gasket; PVC loses pliability below 0°C (32°F). Dust Covers reduce depth of switch behind panel by .020" (0.5mm).

## ASSEMBLY INSTRUCTIONS

### Lamp Installation & LED Orientation

#### Incandescent & Neon Lamps AT607 & AT607N

Align projections on lamp with grooves (B) in holder when inserting lamp. To correctly join the lamp holder and cap base, match the cut corners (A).



#### Bright LED AT627

##### Panel Seal Models

For panel seal models, Bright LED must first be inserted into the lamp socket which is built into the switch. The cap can then be placed on the switch.



##### Snap-in Models

For snap-in models, Bright LED must be inserted into the cap first. Align cut corners (C) when inserting the LED.



#### Bright & Super Bright LEDs AT625, AT631, AT632, AT635

Align D-flat on LED with flat (B) in holder when inserting the LED. To correctly join the lamp holder and cap base, match the cut corners (A).



### Switch & Cap Assembly

#### Round & Rectangular

Match clip on cap assembly with receptacle inside switch. Lamp terminals will then be aligned correctly with lamp socket.



#### Square

Match projection (C) on cap assembly with groove (C) inside switch. Lamp terminals will then be aligned correctly with lamp socket.



#### Panel Seal

With Lamps AT607, AT607N, and LEDs AT614, AT625, AT631, AT632: Match projection on cap assembly with notch inside switch. Lamp terminals will then be aligned correctly with lamp socket.

### Installation & Maintenance

#### Snap-in Mount

Snap-in clip holds all switches firmly in place. To mount round switch, match the antirotation projection on switch with guide cut in panel. Snap into panel cutout.



#### Panel Seal Bushing Mount

Insert switch from the front of the panel with the o-ring between the built-in bezel and the panel. Install mounting nut AT075 (supplied with switch) from the rear of the panel. Overtightening mounting nut may damage the switch housing.



#### Lamp Replacement

Actuator must be in UP position. Pull off cap with cap extractor AT109. Replace lamp and reassemble as shown above.



AT109  
Cap Extractor



AT112  
Socket Wrench

## LEGENDS

NKK Switches can provide custom legends for caps. Contact factory for more information.

### Suggested Printable Area for Lens

**Recommended Methods:** Laser Etch on clear lens, Screen Print, or Pad Print on lens.

Epoxy based ink is recommended.



Shaded areas are printable areas.

### Suggested Printable Area for Film Insert

**Recommended Print Method:** Laser Print or Screen Print with Epoxy based ink

Film Insert: Clear Polyester, 4 mil max. thickness



Shaded areas are printable areas.



Компания «ЭлектроПласт» предлагает заключение долгосрочных отношений при поставках импортных электронных компонентов на взаимовыгодных условиях!

Наши преимущества:

- Оперативные поставки широкого спектра электронных компонентов отечественного и импортного производства напрямую от производителей и с крупнейших мировых складов;
- Поставка более 17-ти миллионов наименований электронных компонентов;
- Поставка сложных, дефицитных, либо снятых с производства позиций;
- Оперативные сроки поставки под заказ (от 5 рабочих дней);
- Экспресс доставка в любую точку России;
- Техническая поддержка проекта, помощь в подборе аналогов, поставка прототипов;
- Система менеджмента качества сертифицирована по Международному стандарту ISO 9001;
- Лицензия ФСБ на осуществление работ с использованием сведений, составляющих государственную тайну;
- Поставка специализированных компонентов (Xilinx, Altera, Analog Devices, Intersil, Interpoint, Microsemi, Aeroflex, Peregrine, Syfer, Eurofarad, Texas Instrument, Miteq, Cobham, E2V, MA-COM, Hittite, Mini-Circuits, General Dynamics и др.);

Помимо этого, одним из направлений компании «ЭлектроПласт» является направление «Источники питания». Мы предлагаем Вам помощь Конструкторского отдела:

- Подбор оптимального решения, техническое обоснование при выборе компонента;
- Подбор аналогов;
- Консультации по применению компонента;
- Поставка образцов и прототипов;
- Техническая поддержка проекта;
- Защита от снятия компонента с производства.



#### Как с нами связаться

**Телефон:** 8 (812) 309 58 32 (многоканальный)

**Факс:** 8 (812) 320-02-42

**Электронная почта:** [org@eplast1.ru](mailto:org@eplast1.ru)

**Адрес:** 198099, г. Санкт-Петербург, ул. Калинина, дом 2, корпус 4, литера А.