

# RFSW6023

2.5V to 5V, 10W SPDT Switch  
150MHz to 5000MHz

The RFSW6023 is a high power single-pole double-throw (SPDT) switch designed for high performance wireless applications. This wideband switch has been designed for use from 50MHz to 5000MHz, where extremely high linearity, high isolation, low insertion loss, and small package size are required. Switching for the RFSW6023 controlled via two control voltage inputs. The RFSW6023 is manufactured in a pHEMT GaAs process and packaged in a 12-pin, 3mm x 3mm, quad-flat (QFN) plastic package.

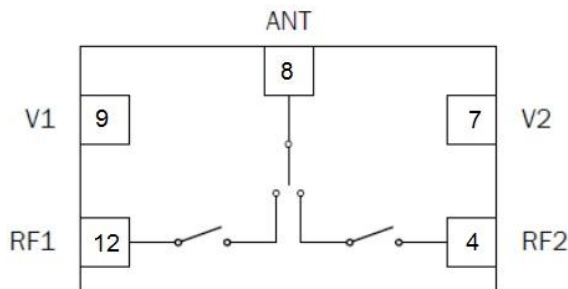

Functional Block Diagram



Package: QFN, 12-pin,  
3.0mm x 3.0mm

## Features

- Single Voltage: 2.5V to 5.0V
- 40dBm P0.1dB
- 25dB Isolation at 2GHz
- High Linearity

## Applications

- Wireless Infrastructure
- ISM Band Transmitter
- WiMax
- WLAN

## Ordering Information

RFSW6023SQ	Sample bag with 25 pieces
RFSW6023SR	7" Reel with 100 pieces
RFSW6023TR7	7" Reel with 2500 pieces
RFSW6023PCK-410	150MHz to 5000MHz PCBA with 5-piece sample bag

## Absolute Maximum Ratings

Parameter	Rating	Unit
Supply Voltage (RF Applied)	-0.5 to +5.0	V
Supply Voltage (No RF Applied)	-0.5 to +5.0	V
DC Supply Current	10	mA
Input Peak Envelope Power	+40*	dBm
Max Input Power, OFDM Modulated, 3:1 Load VSWR	+36	dBm
Max Input 3:1 VSWR	36	dBm
Operating Ambient Temperature	-40 to +85	°C
Junction Temperature	150	°C
Storage Temperature	-40 to +150	°C
Moisture Sensitivity Level	MSL1	

\*Maximum input power with a 50Ω load.

## Nominal Operating Parameters

Parameter	Specification			Unit	Condition
	Min	Typ	Max		
<b>Low Band Performance</b>					<b>Temp = 25°C, VC = 3V, unless otherwise noted</b>
Frequency Range	100		2000	MHz	
Insertion Loss		0.4	0.7	dB	
Input P <sub>0.1dB</sub>		40		dBm	
Input Return Loss		20		dB	
Isolation		25		dB	2000MHz
Harmonics (2 <sup>nd</sup> , 3 <sup>rd</sup> )		80		dBc	At P <sub>OUT</sub> = 30dBm, 880MHz
Input IP3		59		dBm	150MHz, 23dBm/tone
<b>High Band Performance</b>					<b>Temp = 25°C, VC = 3V, unless otherwise noted</b>
Frequency Range	2000		5000	MHz	
Insertion Loss		0.6	0.8	dB	
Input P <sub>0.1dB</sub>		40		dBm	
Input Return Loss		15		dB	
Isolation		26		dB	3800MHz
Harmonics (2 <sup>nd</sup> , 3 <sup>rd</sup> )		80		dBc	At P <sub>OUT</sub> = 30dBm, 2140MHz
Input IP3		59		dBm	2000MHz, 23dBm/tone
<b>Control Voltage</b>					
Control Voltage High	2.5	3	5	V	
Control Voltage Low			0.2	V	
Control Current		5		μA	



**Caution!** ESD sensitive device.



RFMD Green: RoHS status based on EU Directive 2011/65/EU (at time of this document revision), halogen free per IEC 61249-2-21, < 1000ppm each of antimony trioxide in polymeric materials and red phosphorus as a flame retardant, and <2% antimony in solder.

Exceeding any one or a combination of the Absolute Maximum Rating conditions may cause permanent damage to the device. Extended application of Absolute Maximum Rating conditions to the device may reduce device reliability. Specified typical performance or functional operation of the device under Absolute Maximum Rating conditions is not implied.

Parameter	Specification			Unit	Condition
	Min	Typ	Max		
<b>Generic Performance</b>					
Switching Speed High		300	500	ns	50% CTL to 90/10% RF
Switching Speed Low		100	300	ns	90/10% RF to 10/90% RF
ESD					
Human Body Model	250			V	EIA/JESD22-114A RF pins
	500			V	EIA/JESD22-114A DC pins
Charge Device Model	1000			V	JESD22-C101C all pins

## Control Truth Table

Switch Status		Logic Control	
RF1 to RFC	RF2 to RFC	VRF1	VRF2
On	Off	High	Low
Off	On	Low	High

### Typical Performance: Low Band

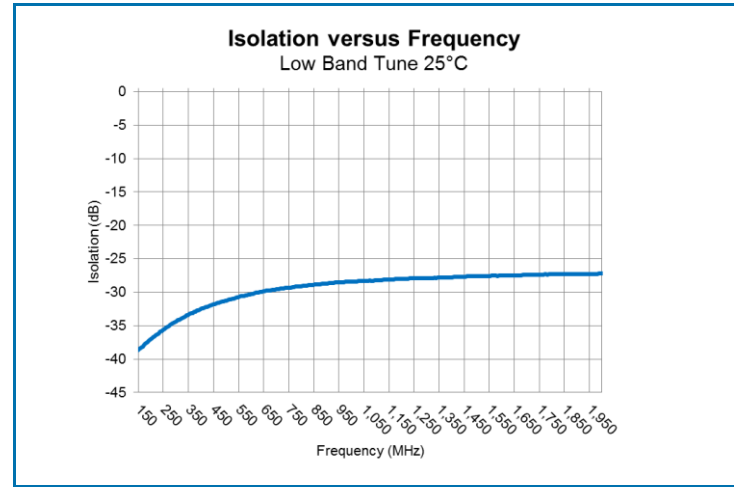
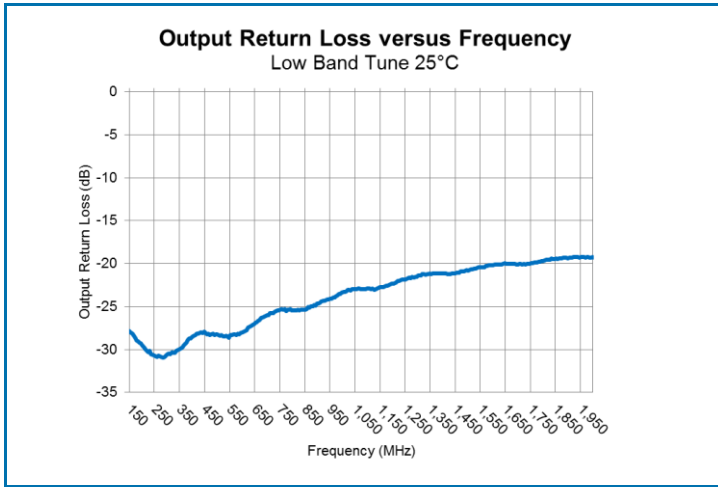
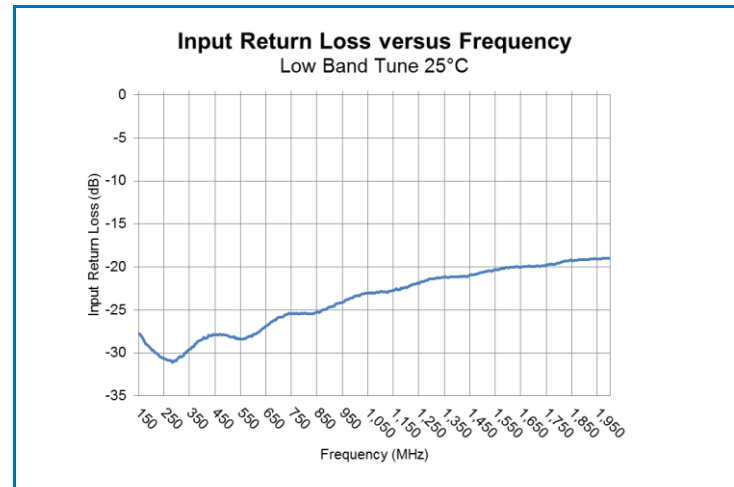
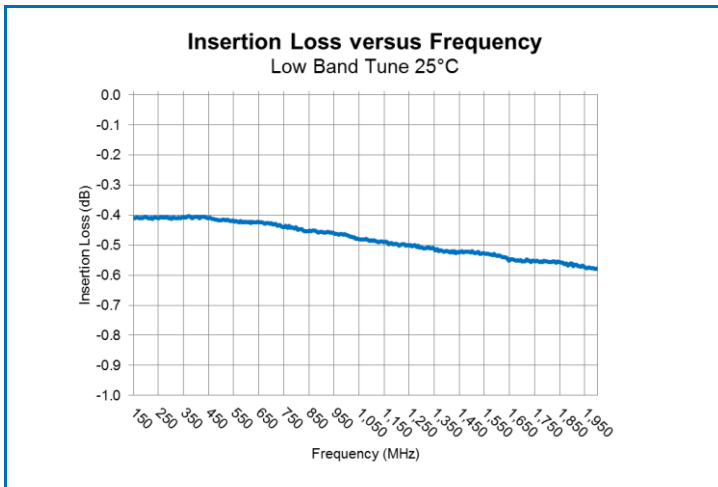

Typical Performance: High Band

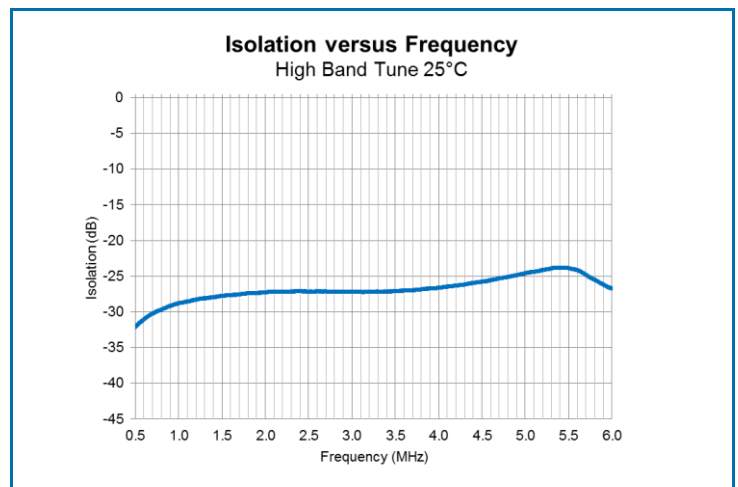
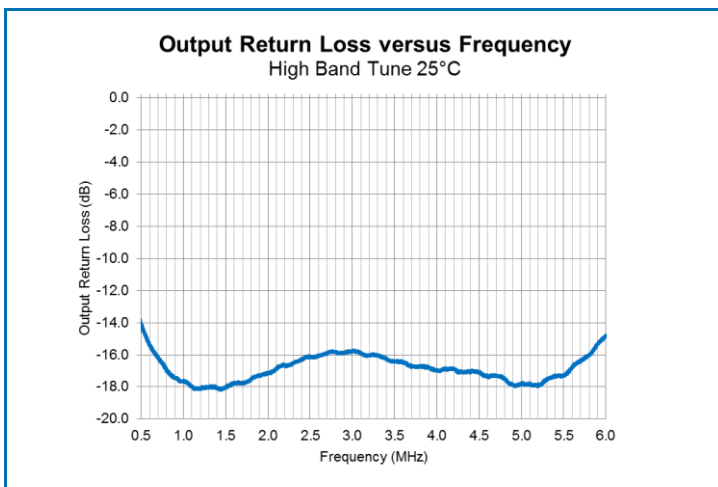
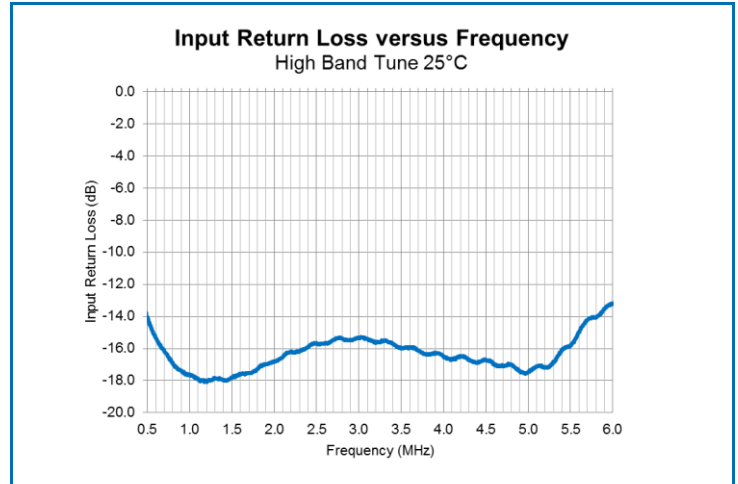
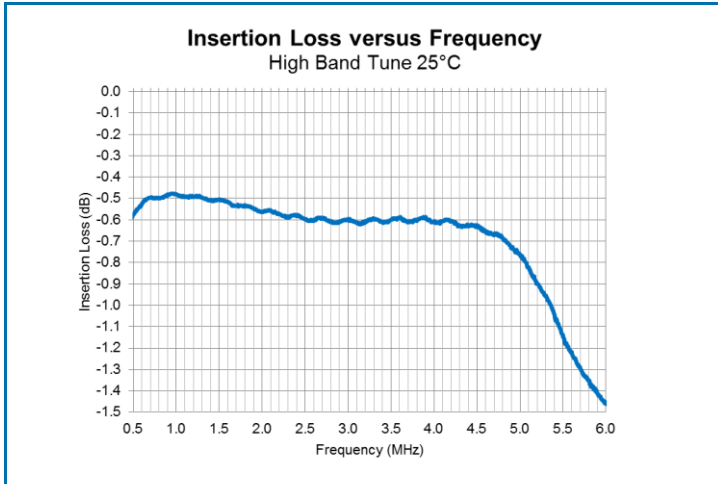

Evaluation Board Schematic

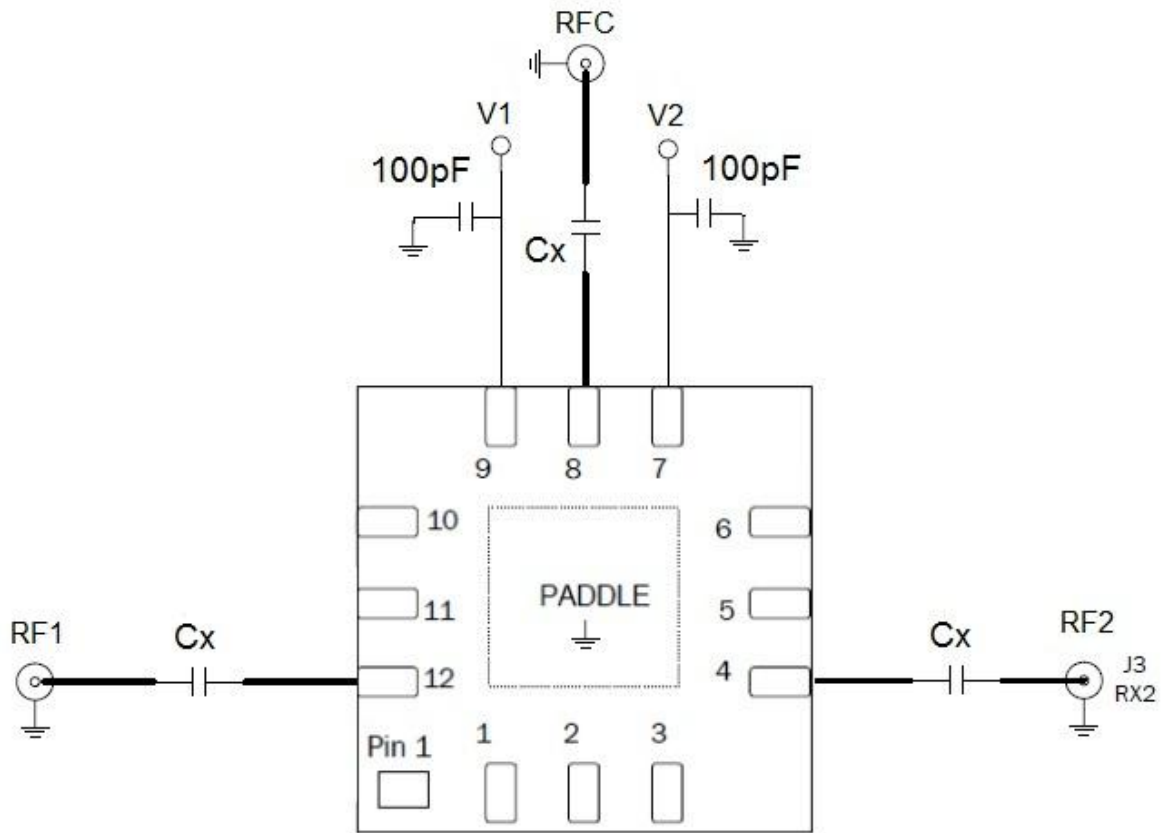

DC Block Values	
Frequency Range	
100MHz to 2000MHz	1.0nF
2000MHz to 4500MHz*	33pF

\* Standard Eval board

Evaluation Board Assembly Drawing

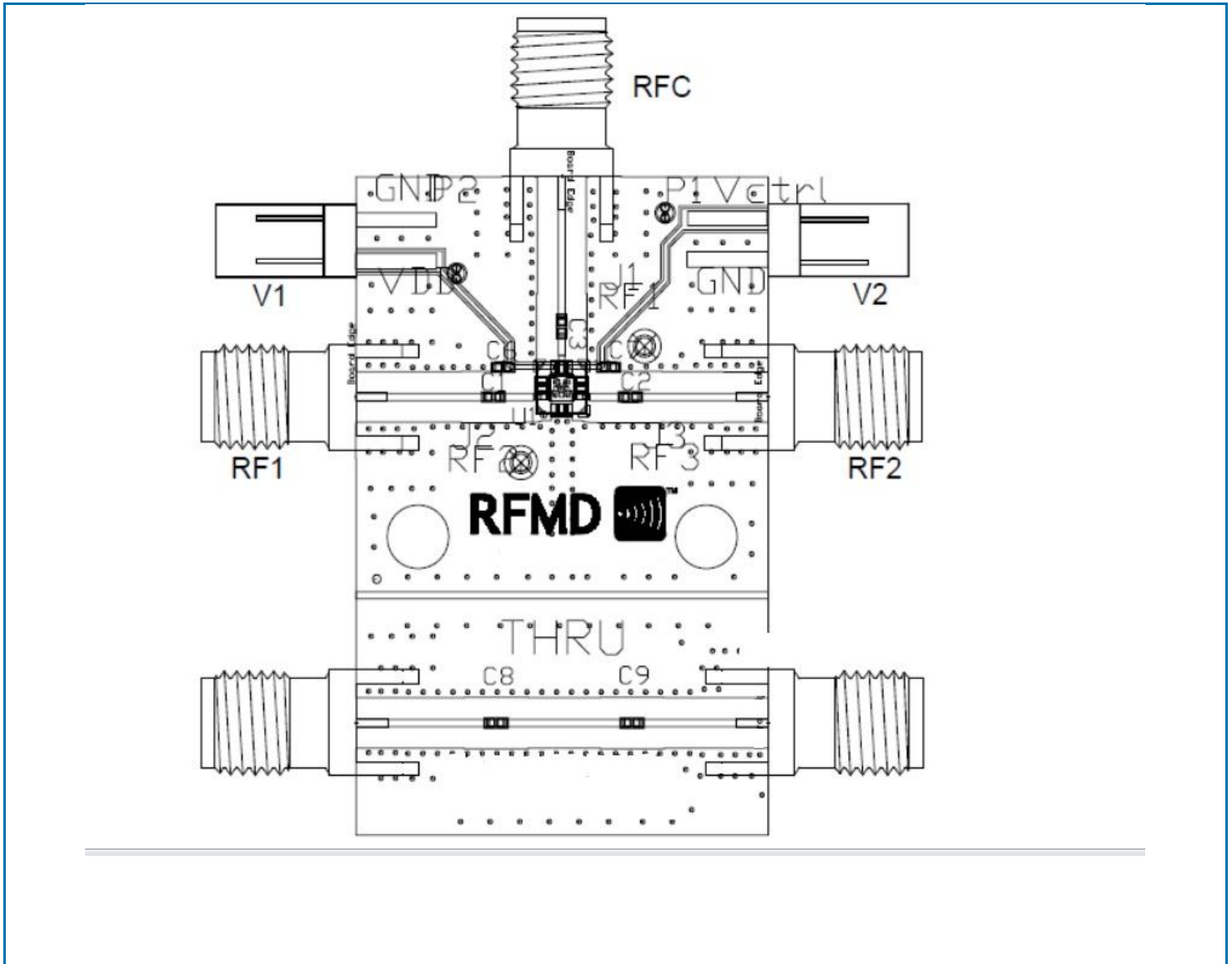

## Pin Names and Descriptions

Pin	Name	Description
1	NC	No connect
2	NC	No connect
3	NC	No connect
4	RF2	RF Port 2, DC block required
5	NC	No connect
6	NC	No connect
7	V2	V2 Logic Control Voltage
8	ANT RF	RF Common Port, DC block required
9	V1	V1 Logic Control Voltage
10	NC	No connect
11	NC	No connect
12	RF1	RF Port 1, DC block required
	Paddle	Ground

## Pin Layout

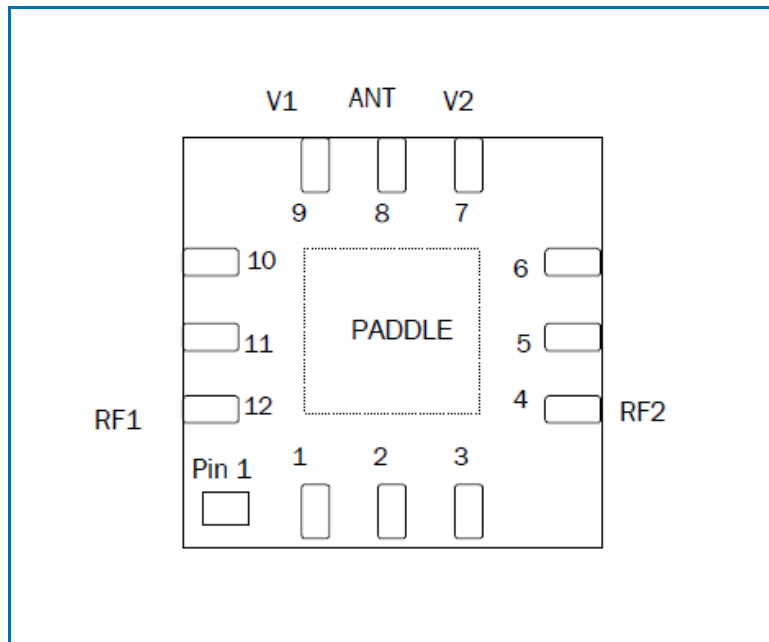



### Package Outline Drawing (Dimensions in millimeters)

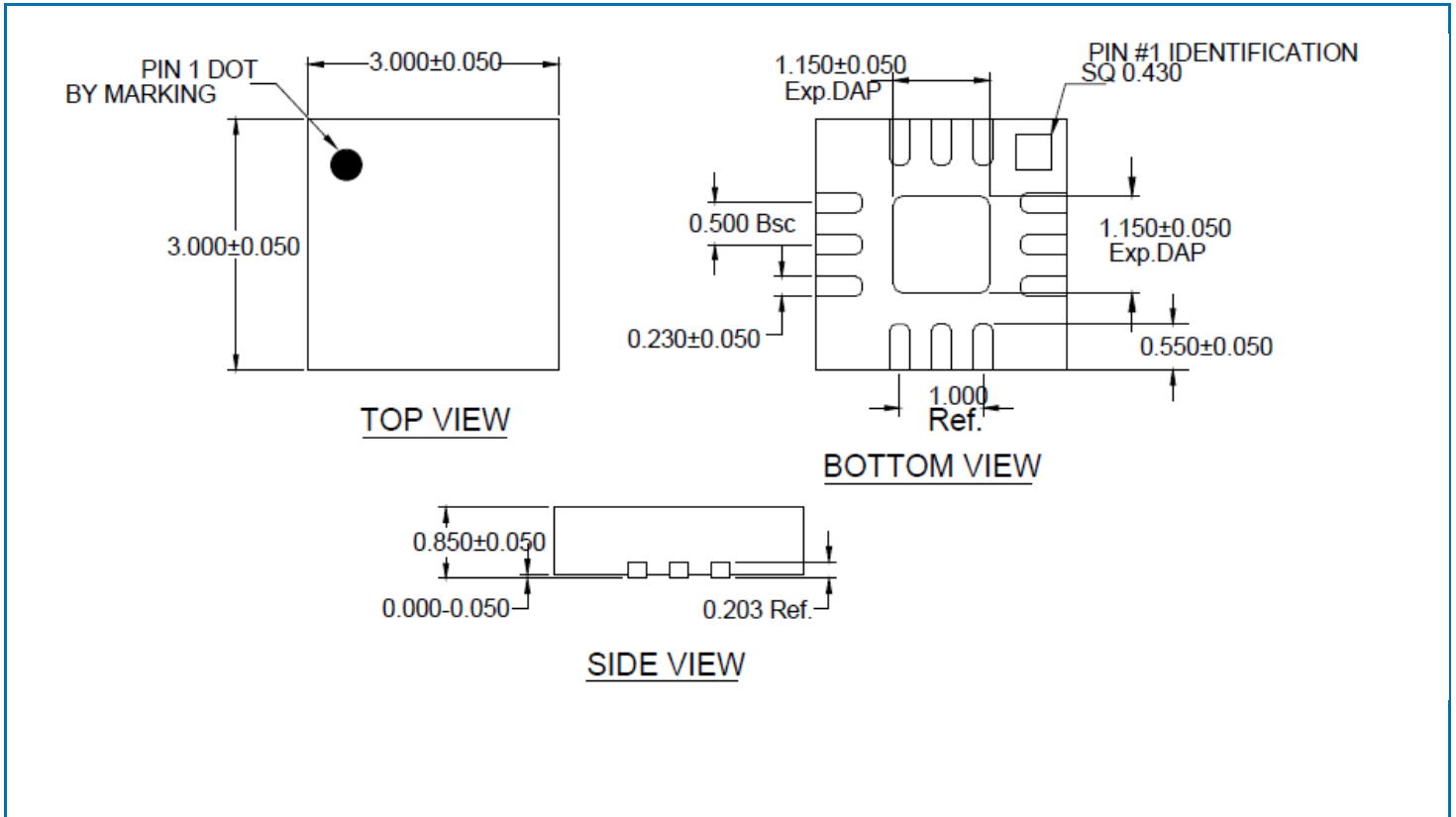

## Branding Diagram

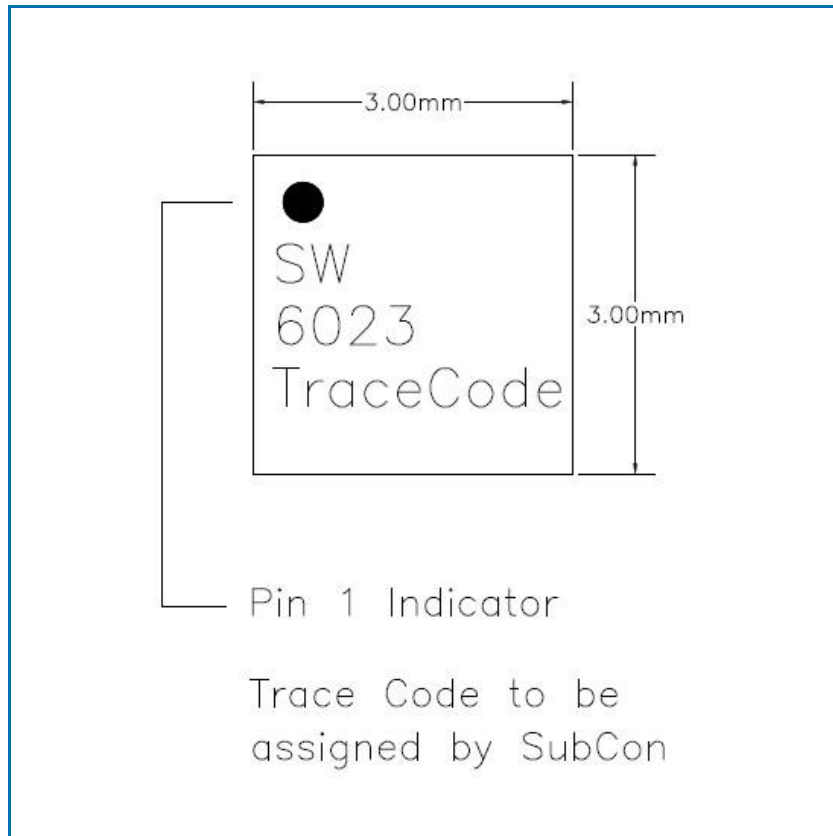



Компания «ЭлектроПласт» предлагает заключение долгосрочных отношений при поставках импортных электронных компонентов на взаимовыгодных условиях!

Наши преимущества:

- Оперативные поставки широкого спектра электронных компонентов отечественного и импортного производства напрямую от производителей и с крупнейших мировых складов;
- Поставка более 17-ти миллионов наименований электронных компонентов;
- Поставка сложных, дефицитных, либо снятых с производства позиций;
- Оперативные сроки поставки под заказ (от 5 рабочих дней);
- Экспресс доставка в любую точку России;
- Техническая поддержка проекта, помощь в подборе аналогов, поставка прототипов;
- Система менеджмента качества сертифицирована по Международному стандарту ISO 9001;
- Лицензия ФСБ на осуществление работ с использованием сведений, составляющих государственную тайну;
- Поставка специализированных компонентов (Xilinx, Altera, Analog Devices, Intersil, Interpoint, Microsemi, Aeroflex, Peregrine, Syfer, Eurofarad, Texas Instrument, Miteq, Cobham, E2V, MA-COM, Hittite, Mini-Circuits, General Dynamics и др.);

Помимо этого, одним из направлений компании «ЭлектроПласт» является направление «Источники питания». Мы предлагаем Вам помощь Конструкторского отдела:

- Подбор оптимального решения, техническое обоснование при выборе компонента;
- Подбор аналогов;
- Консультации по применению компонента;
- Поставка образцов и прототипов;
- Техническая поддержка проекта;
- Защита от снятия компонента с производства.



#### Как с нами связаться

**Телефон:** 8 (812) 309 58 32 (многоканальный)

**Факс:** 8 (812) 320-02-42

**Электронная почта:** [org@eplast1.ru](mailto:org@eplast1.ru)

**Адрес:** 198099, г. Санкт-Петербург, ул. Калинина, дом 2, корпус 4, литера А.