

LCL Series



- Single Output Industrial Supplies
- High Efficiency
- Low Cost
- 150 W Convection Cooled
- 300 W & 500 W with Internal Fans
- Outputs form 12 V to 48 V
- 3 Year Warranty

The LCL series is a low cost chassis mount product that is popular in industrial applications. The AC/DC supplies are enclosed in a metal case with terminal block input and output connectors. Three series offer 150, 300 and 500 Watts. Each power range includes six single output models from 12 to 48 VDC. The user adjustable outputs cover all nominal voltage ranges. The LCL150 is convection cooled while the 300 and 500 Watt have internal fans.

All LCL models are approved to ITE (60950-1) safety standards and meet EN55022 Level B conducted emissions. Operating temperature range is from -10 °C to +70 °C with derating above +50 °C. Standard features include overvoltage, overload, short circuit, and over temperature protection. Remote sense is included on the LCL500 with Remote On/Off available with the LCL300 and LCL500.

Models and Ratings

Output Power	Output Voltage	Trim Range	Output Current	Ripple & Noise ⁽¹⁾	Model Number
150 W	12.0V	11.0-13.0V	12.5 A	100 mV pk-pk	LCL150PS12
	13.5V	12.5-14.5V	11.1 A	100 mV pk-pk	LCL150PS13
	15.0V	14.0-16.0V	10.0 A	100 mV pk-pk	LCL150PS15
	24.0V	23.0-25.0V	6.3 A	150 mV pk-pk	LCL150PS24
	27.0V	26.0-28.0V	5.6 A	150 mV pk-pk	LCL150PS27
	48.0V	47.0-49.0V	3.1 A	250 mV pk-pk	LCL150PS48
300 W	12.0V	11.0-13.0V	25.0 A	150 mV pk-pk	LCL300PS12
	13.5V	12.5-14.5V	22.0 A	150 mV pk-pk	LCL300PS13
	15.0V	14.0-16.0V	20.0 A	150 mV pk-pk	LCL300PS15
310 W	24.0V	23.0-25.0V	13.0 A	150 mV pk-pk	LCL300PS24
315 W	27.0V	26.0-28.0V	11.7 A	200 mV pk-pk	LCL300PS27
320 W	48.0V	47.0-49.0V	6.70 A	240 mV pk-pk	LCL300PS48
500 W	12.0V	11.0-13.0V	42.0 A	120 mV pk-pk	LCL500PS12
	13.5V	12.5-14.5V	37.0 A	150 mV pk-pk	LCL500PS13
	15.0V	14.0-16.0V	34.0 A	150 mV pk-pk	LCL500PS15
	24.0V	23.0-25.0V	21.0 A	150 mV pk-pk	LCL500PS24
	27.0V	26.0-28.0V	18.5 A	150 mV pk-pk	LCL500PS27
	48.0V	47.0-49.0V	10.5 A	240 mV pk-pk	LCL500PS48

Notes:

1. Measured with 20 MHz bandwidth.

Input Characteristics

Characteristic	Minimum	Typical	Maximum	Units	Notes & Conditions
Input Voltage - Operating	85		264	VAC	Derate output power < 90 VAC. See fig. 1.
Input Frequency	47		63	Hz	
Power Factor		>0.9			EN61000-3-2 class A compliant LCL150: EN61000-3-2 class C for loads ≥40% LCL300 & LCL500: EN61000-3-2 class C for loads ≥40%
Input Current - Full Load			2.1 4.5 6.6	A	LCL150 at 90 VAC LCL300 at 90 VAC LCL500 at 90 VAC
Inrush Current			50 60	A	LCL150, 230 VAC, cold start 25 °C LCL300 & LCL500, 230 VAC, cold start 25 °C
Earth Leakage Current			<2	mA	264 VAC/60 Hz
Input Protection	T3.15 A/250 V internal in-line fuse				LCL150
	T6.3 A/250 V internal in-line fuse				LCL300
	T10 A/250 V internal in-line fuse				LCL500

Input Derating Curve

Figure 1

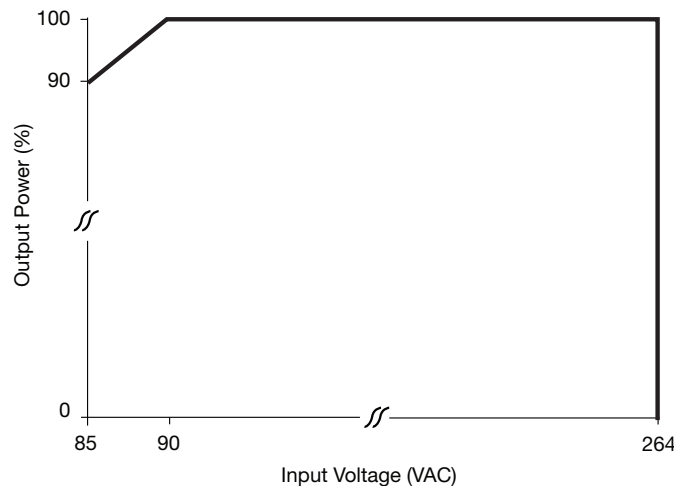

Output Characteristics

Characteristic	Minimum	Typical	Maximum	Units	Notes & Conditions
Output Voltage - V1	12		48	VDC	See Models and Ratings table
Initial Set Accuracy			±100	mV	50% load
Output Voltage Adjustment	±1			V	See Models and Ratings table
Minimum Load	0			A	
Start Up Delay			2	s	
Start Up Rise Time			65	ms	LCL150
			80		LCL300
			35		LCL500
Hold Up Time	10			ms	115 VAC full load
Line Regulation			±0.5	%	LCL150
			±0.3		LCL300 & LCL500
Load Regulation			±1	%	
Transient Response			4	%	Recovery within 1% in less than 500 μ s for a 50% load change
Ripple & Noise					See Models and Ratings table
Overvoltage Protection	110		140	%	Recycle input to reset
Overload Protection	110		150	%	Rated output power, delayed by 1 s minimum to allow peak loads. See fig 2, 3 & 4
Short Circuit Protection					Auto recovery, hiccup mode
Overtemperature Protection					Output turns off when OTP triggered, measured internally (Q1 temperature), auto recover when internal temperature was reduced.

Output Overload Characteristics

Figure 2 - LCL150PS12

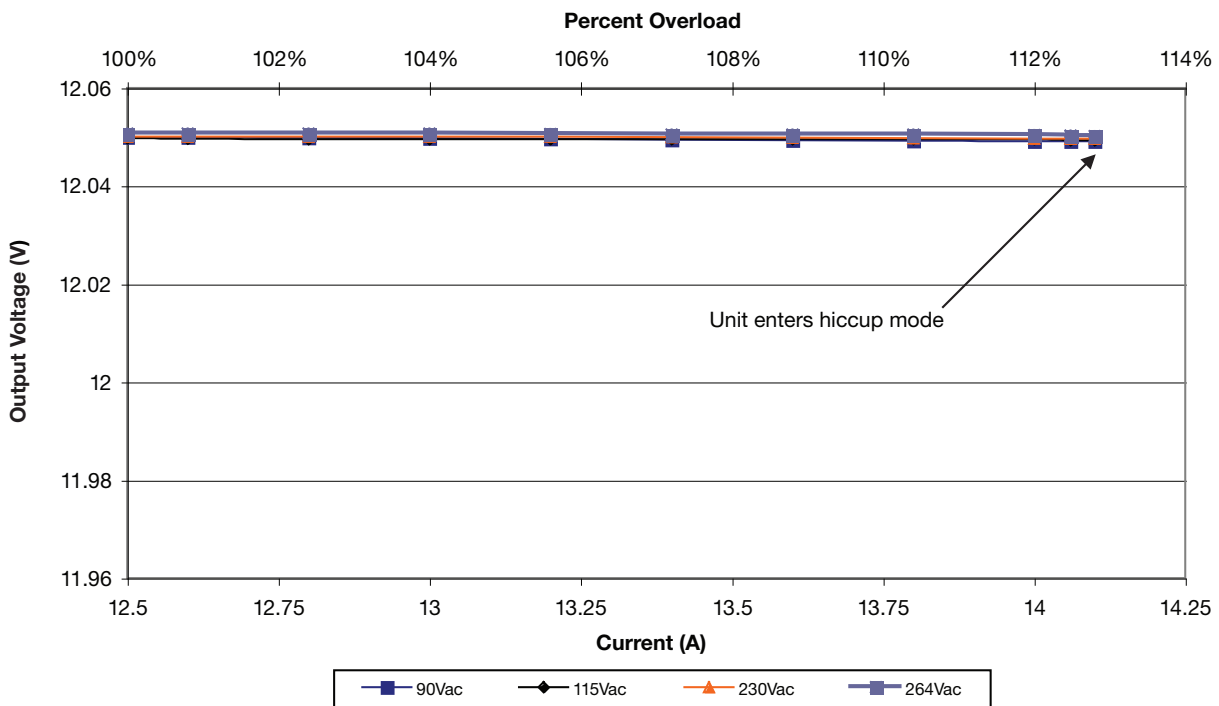

Output Overload Characteristics

Figure 3 - LCL300PS24

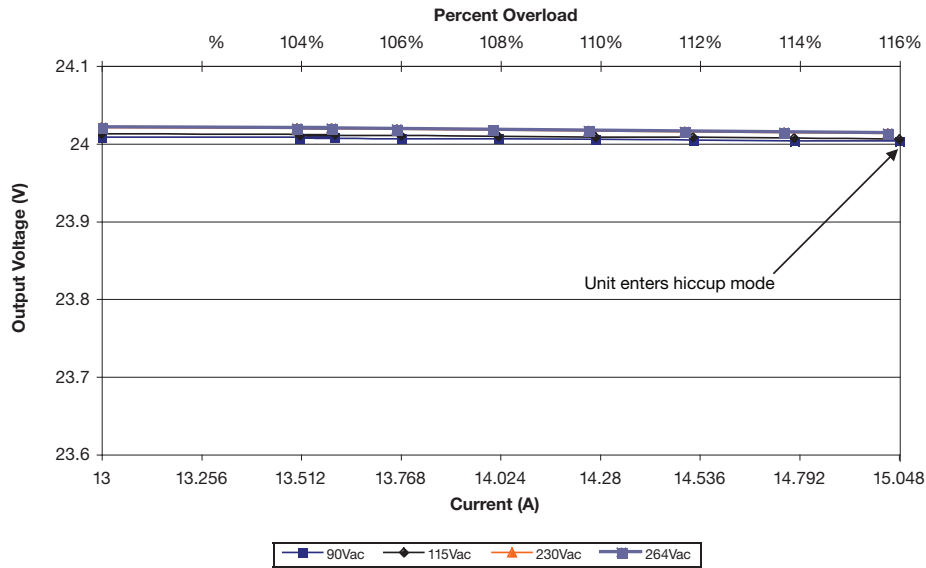
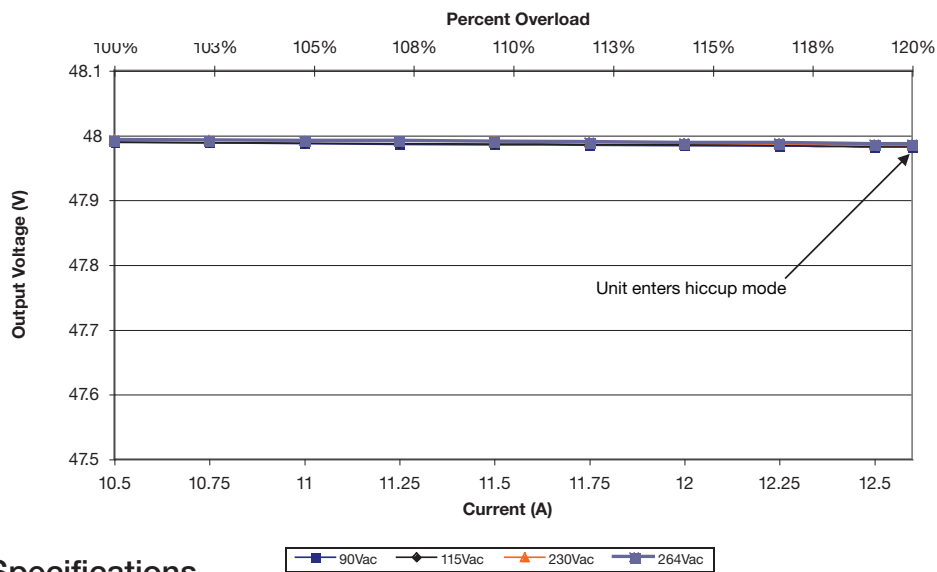

Figure 4 - LCL500PS48



General Specifications

Characteristic	Minimum	Typical	Maximum	Units	Notes & Conditions
Efficiency	85	88		%	230 VAC full load, See fig 5, 6 & 7
Isolation: Input to Output Input to Ground Output to Ground	3000			VAC	
	1500				
	500				
Switching Frequency	45		190	kHz	PFC Converter
	90		110		Main Converter
	62		65		PFC Converter
	80		190		Main converter
Power Density			2.7	W/in ³	LCL150
			4.4		LCL300
			4.9		LCL500
MTBF		200		kHrs	MIL-HDBK-217F at 25 °C, GB
Weight			1.39 (630)	lb (g)	LCL150
			1.94 (880)	lb (g)	LCL300
			3.2 (1.45)	lb (kg)	LCL500
					See mechanical details

Efficiency vs Load

Figure 5 - LCL150PS12

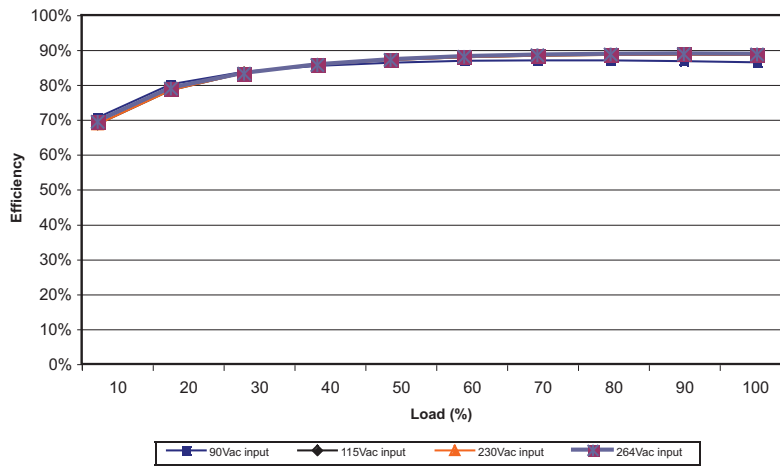

Figure 6 - LCL300PS24

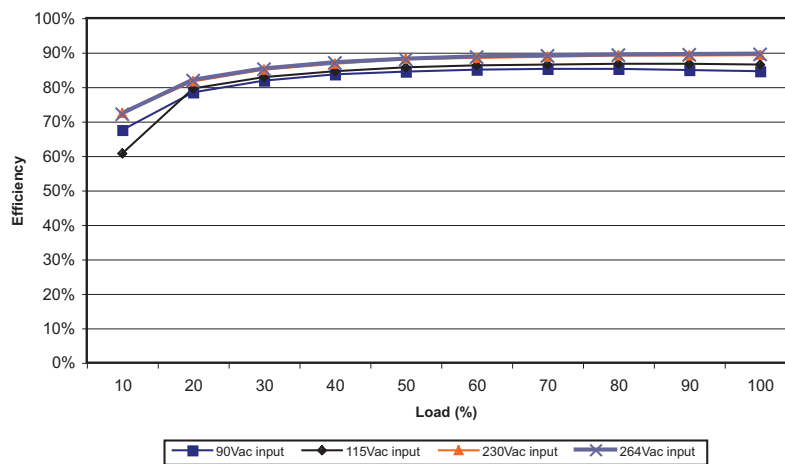
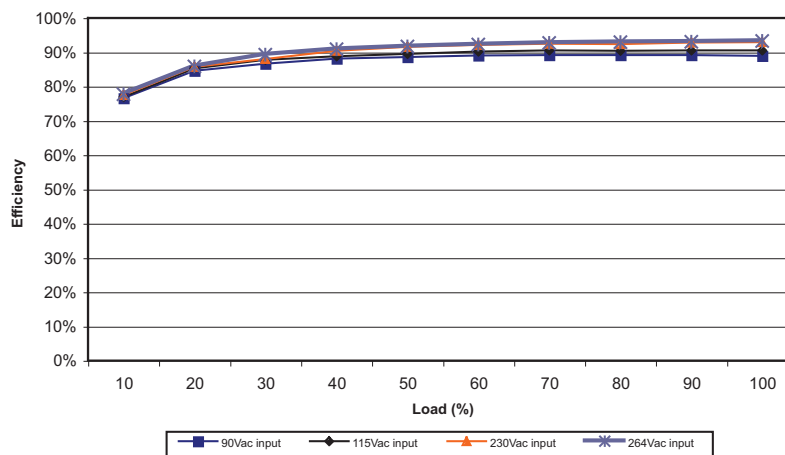

Figure 7 - LCL500PS48



Signals & Controls

Characteristics	Notes and Conditions
Remote Sense	Compensates for 0.25 V max each line. Fitted to LCL500 only.
Remote On/Off	Fitted on LCL500. On = logic low or open circuit, OFF = logic high

Figure 8 - Remote Sense Connection Diagram

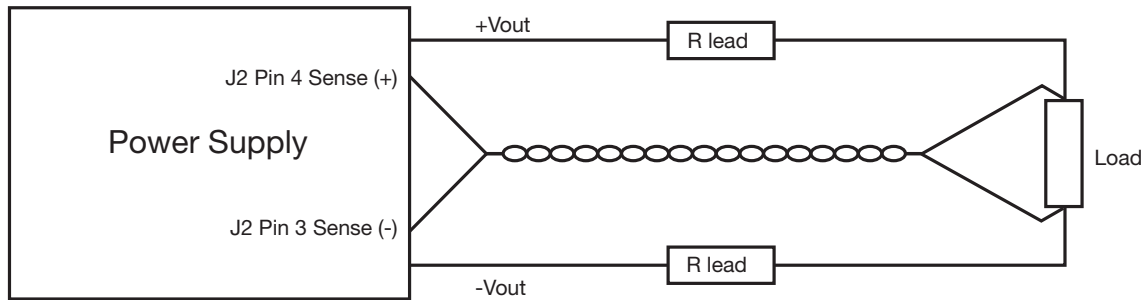
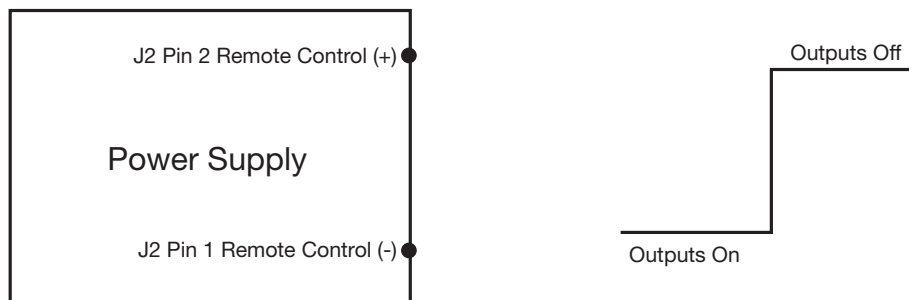

Figure 9 - Remote On/Off



1. Applying $<0.8\text{ V}$ on Pin 2 with respect to Pin 1 or open circuit, output turns ON.
2. Applying $>4.5\text{ V}$ on Pin 2 with respect to Pin 1, output turns OFF

Environmental

Characteristic	Minimum	Typical	Maximum	Units	Notes & Conditions
Operating Temperature	-10		70	°C	LCL150 & LCL300: Derates linearly from 100% load at 50 °C to 50% load at 70 °C (see fig 10). At -10 °C, 90 VAC, start up time increases to 4 s (LCL150) LCL500: Derates linearly from 100% load at 55 °C to 50% load at 70 °C (see fig. 11). At -10 °C, 90 VAC, start up time increases to 5 s.
Storage Temperature	-40		85	°C	
Cooling					LCL150 convection cooled, LCL300 & LCL500 have internal fans.
Humidity	5		95	%RH	Non-condensing
Operating Altitude			3000	m	
Vibration	2			g	10-500 Hz, 10 mins per cycle on 3 axes

Temperature Derating Curve

Figure 10 - LCL150 & LCL300

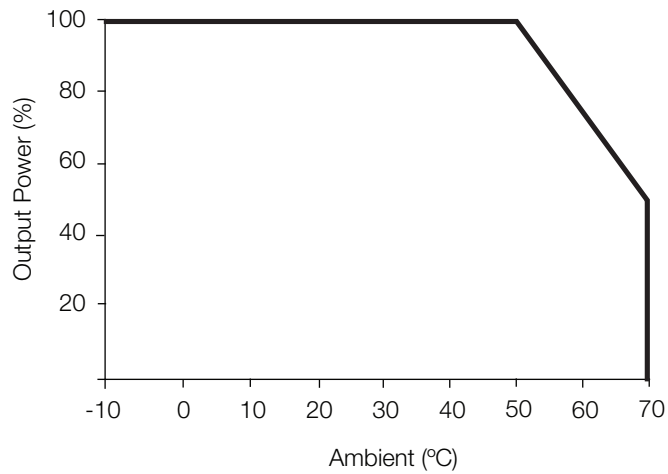
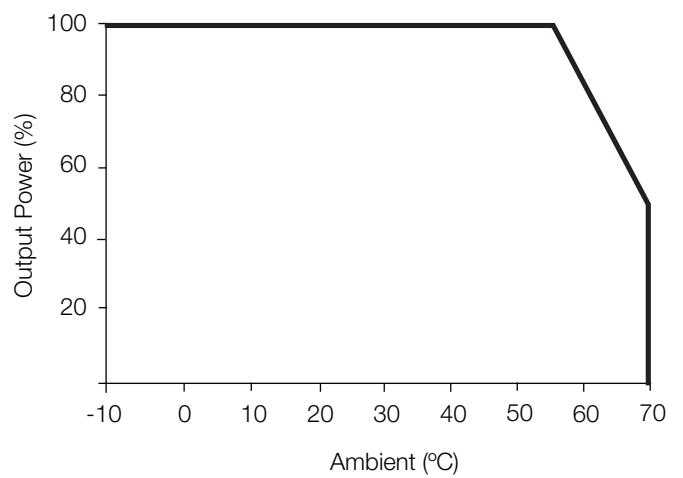

Figure 11 - LCL500



Electromagnetic Compatibility - Immunity (high severity level, EN61204-3)

Phenomenon	Standard	Test Level	Criteria	Notes & Conditions
ESD	EN61000-4-2	±4 kV	A	Contact Discharge
		±8 kV		Air Discharge
		±8 kV		Coupling Plane Discharge
Radiated RF	EN61000-4-3	2	A	
EFT	EN61000-4-4	2	A	
Surge	EN61000-4-5	Installation Class 3	A	LCL150 & LCL300
		Installation Class 2		LCL500
Conducted RF	EN61000-4-6	2	A	
Magnetic Field	EN61000-4-8	1 A/m	A	
Dips and Interruptions	EN61000-4-11	Dip: 30% 10 ms	A	
		Dip: 60% 100 ms	B	
		Dip: 100% 5000 ms	B	

ESD Points

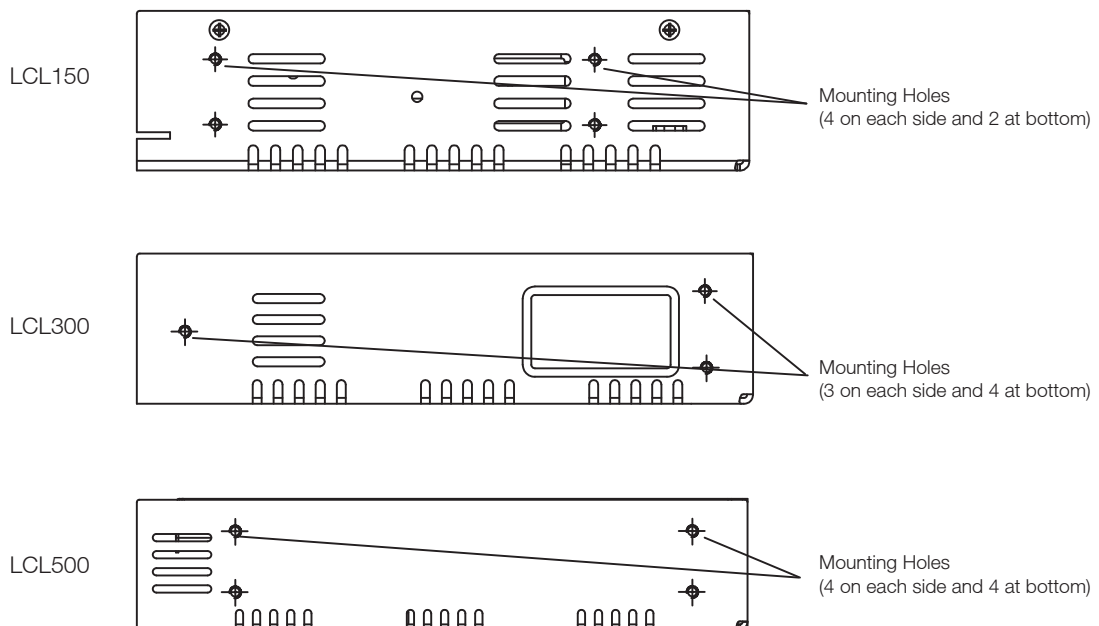

10 discharges at each polarity were applied at points indicated (contact and air discharges)

Electromagnetic Compatibility - Emissions

Phenomenon	Standard	Test Level	Criteria	Notes & Conditions
Conducted	EN55022	Class B		
Radiated	EN55022	Class A		
Harmonic Currents	EN61000-3-2	Class A Equipment		

Conducted Emission Plots

Figure 15 - QP Detector - LCL150PS12

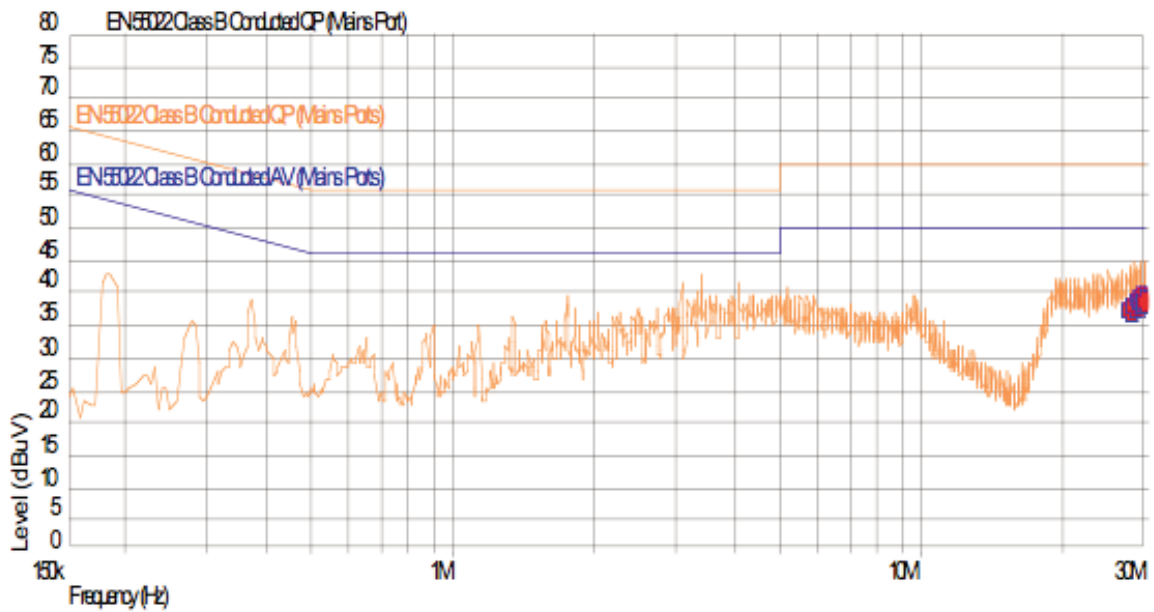
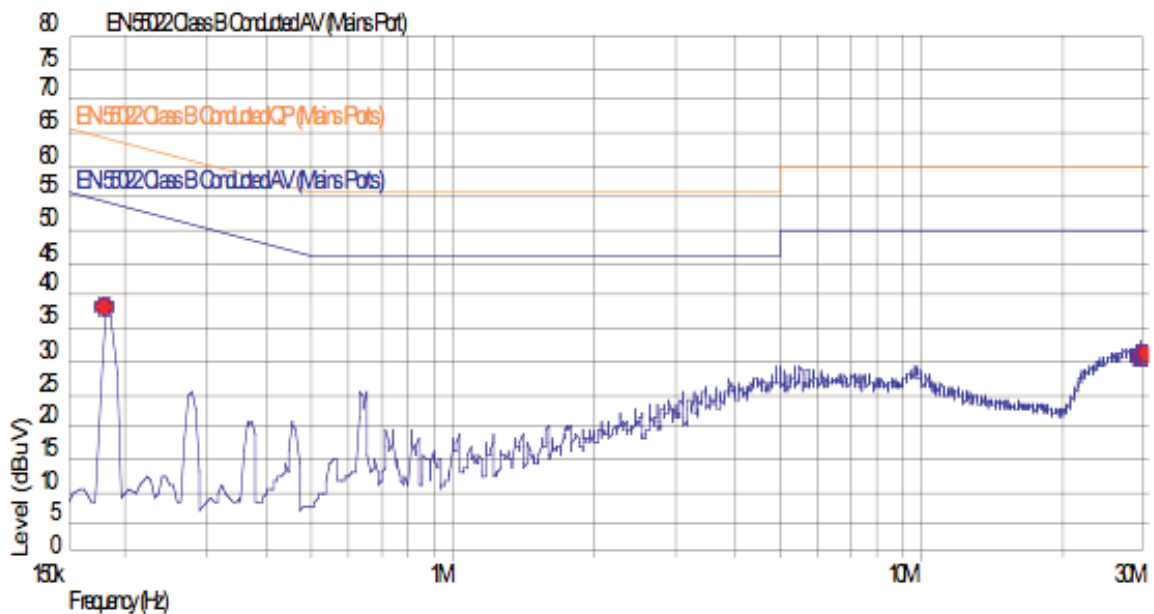

Figure 15 - AV Detector - LCL150PS12



Conducted Emission Plots

Figure 16 - QP Detector - LCL300PS24

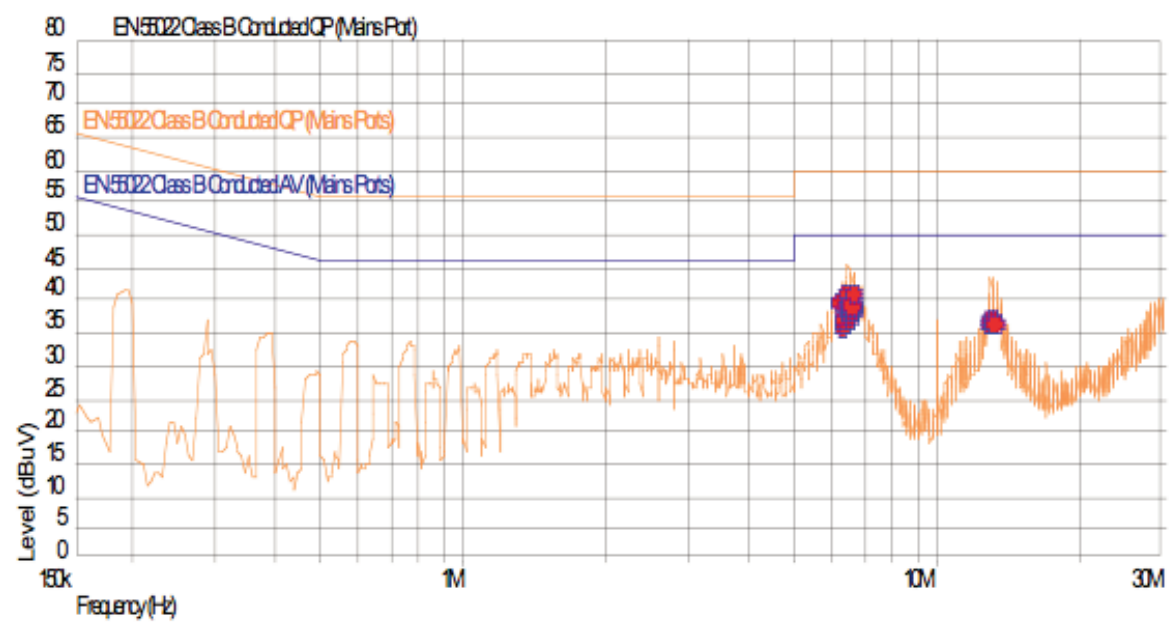
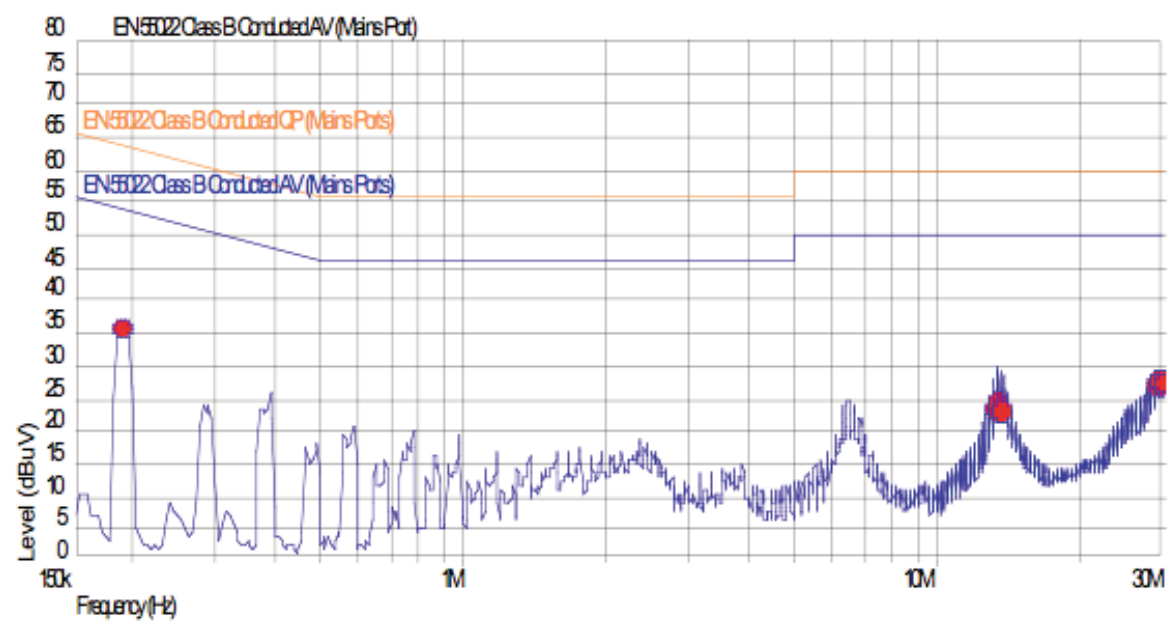

Figure 16 - AV Detector - LCL300PS24



Conducted Emission Plots

Figure 17 - QP Detector - LCL500PS48

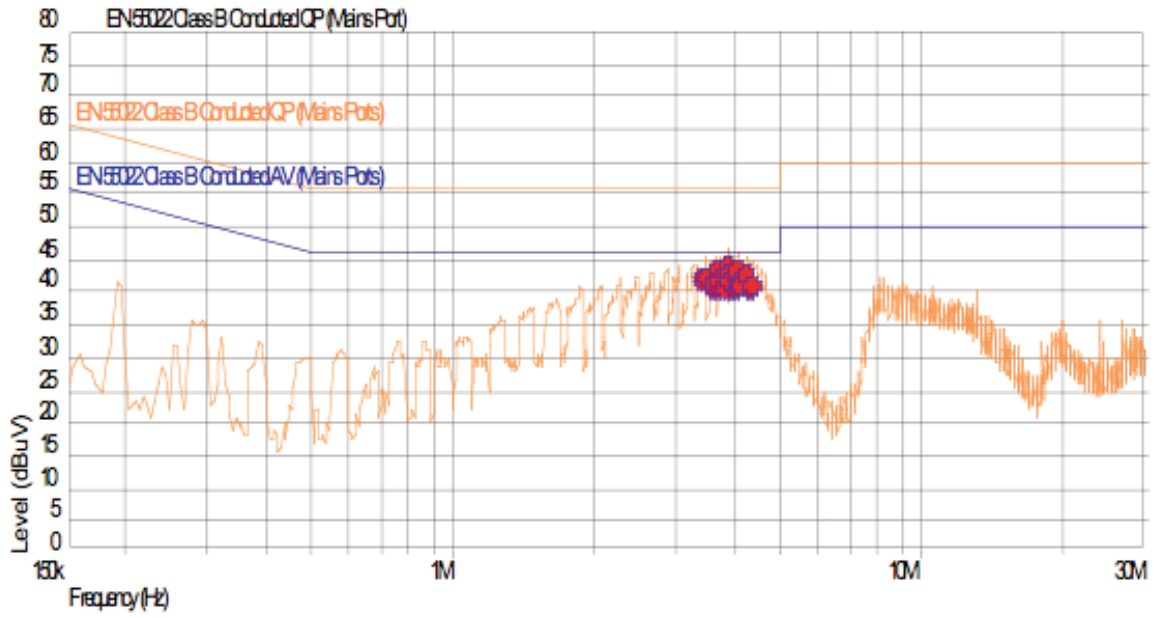
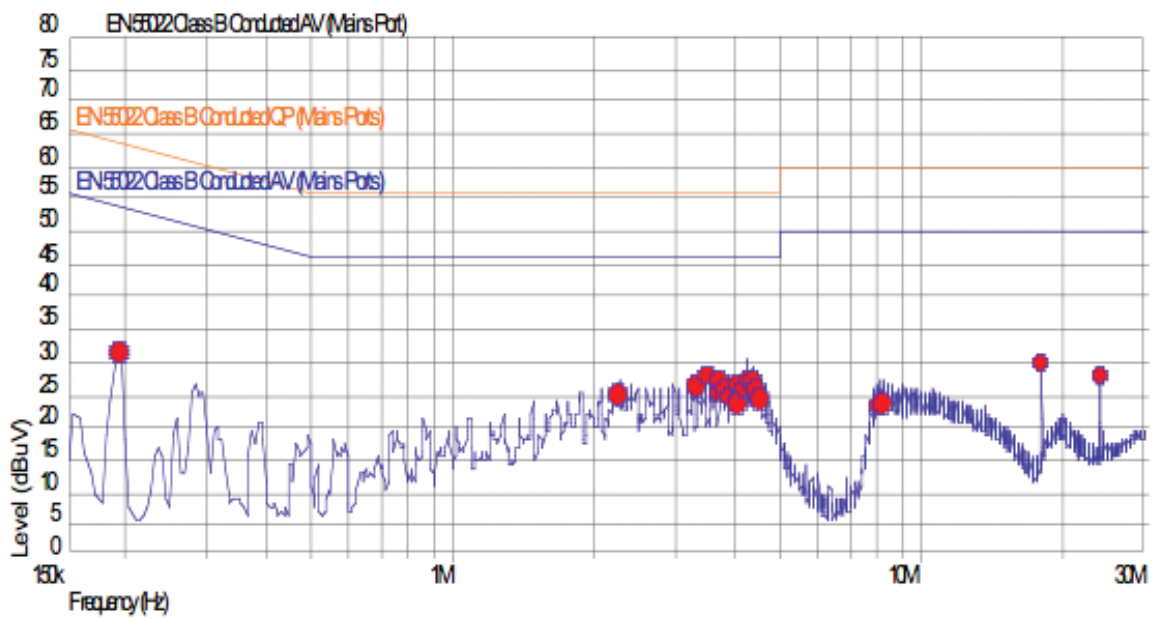

Figure 17 - AV Detector - LCL500PS48



Safety Agency Approvals

Safety Agency	Safety Standard	Category	
CB Report	US/14041/UL IEC 60950-1 (2005) Ed 2 E139109-A27-CB-1	Information Technology	LCL150
	US/14236/UL IEC 60950-1 (2005) Ed 2 E139109-A29-CB-1		LCL300
	US/14254/UL IEC 60950-1 (2005) Ed 2 E139109-A28-CB-1		LCL500
UL	UL File #E139109 UL60950-1(2007) CSA 22.2 No. 60950-1-07 Ed 2	Information Technology	
TUV	TUV Certificate #B09 07 57396 061 EN60950-1/A11:2009	Information Technology	LCL150
	TUV Certificate #B09 07 57396 062 EN60950-1/A11:2009		LCL300
	TUV Certificate #B09 07 57396 063 EN60950-1/A11:2009		LCL500

Equipment Protection Class	Safety Standard	Notes & Conditions
Class I	IEC 60950-1-2005 Ed 2	See safety agency conditions of acceptability for details

Mechanical Details - LCL150

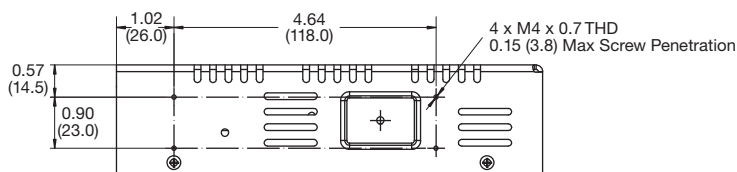
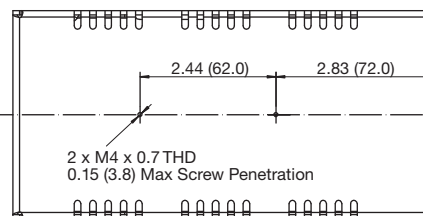
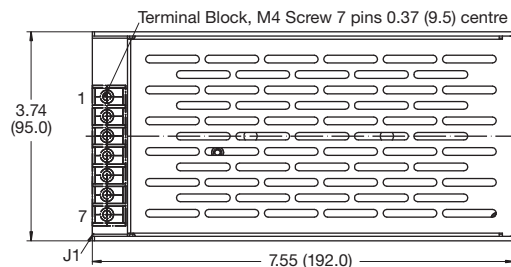
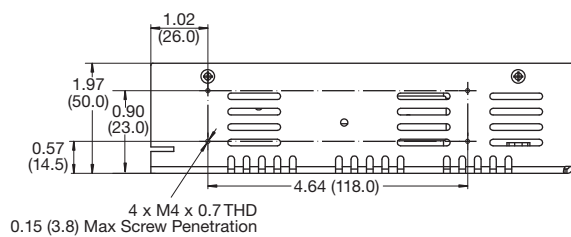

Pin	Function
1	+Vout
2	+Vout
3	-Vout
4	-Vout
5	Ground
6	AC Neutral
7	AC Live

Notes:

Weight: 1.39 lbs (630g) approx.
Dimensions shown in inches (mm).

Tolerance is ± 0.05 (± 0.2) maximum.

Mechanical Details - LCL300

Weight: 1.94 lbs (880g) approx.
 Dimensions shown in inches (mm).
 Tolerance is ± 0.05 (± 0.2) maximum.
 Airflow direction is out of the unit at fan.

J1 Pin Connections	
Pin	Function
1	+Vout
2	+Vout
3	+Vout
4	-Vout
5	-Vout
6	-Vout
7	Ground
8	AC Neutral
9	AC Live

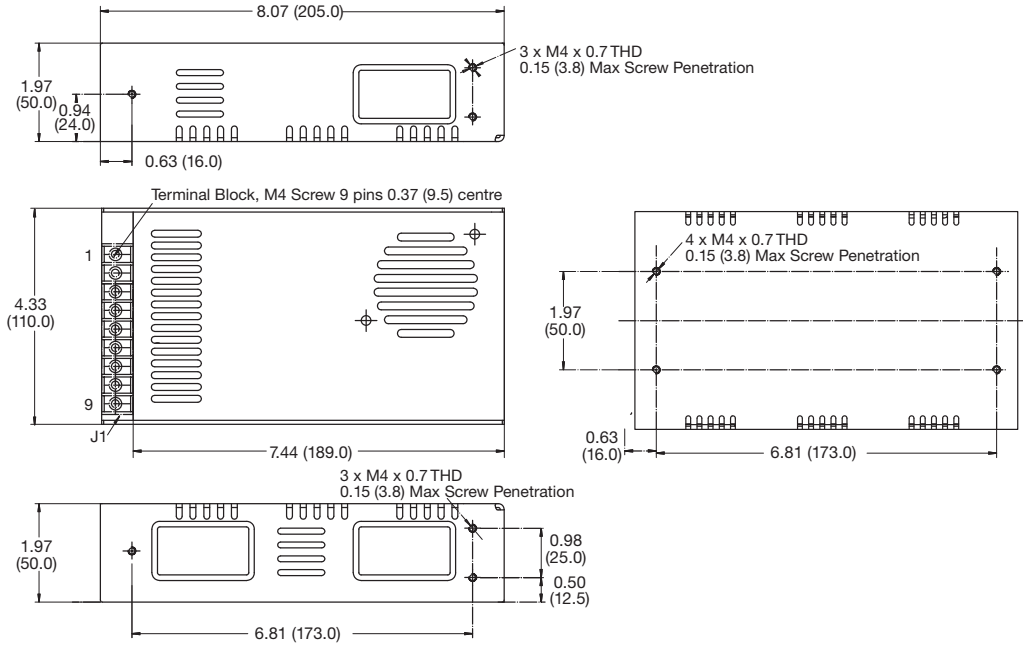

LCL500

Weight: 3.2 lbs (1.45 kg) approx.
 Dimensions shown in inches (mm).
 Tolerance is ± 0.05 (± 0.2) maximum.

J1 Pin Connections	
Pin	Function
1	+Vout
2	+Vout
3	+Vout
4	-Vout
5	-Vout
6	-Vout
7	Ground
8	AC Neutral
9	AC Live

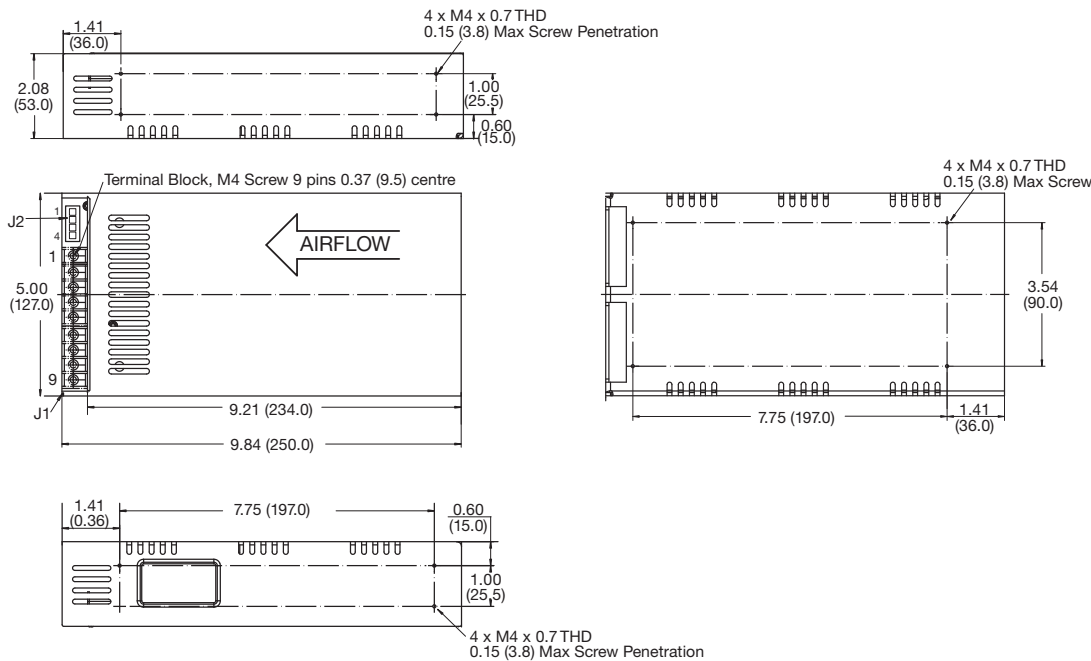

J2 Pin Connections	
Pin	Function
1	Remote Control -
2	Remote Control +
3	Sense -
4	Sense +

Applying $>4.5V$ to Pin 2 with respect to Pin 1 turns output off.
 Applying $<0.8V$ to Pin 2 with respect to Pin 1 or open circuit turns output on.

Mating Connectors (J2):
 WST P4-I25002 housing
 WST I25002BS contacts



Компания «ЭлектроПласт» предлагает заключение долгосрочных отношений при поставках импортных электронных компонентов на взаимовыгодных условиях!

Наши преимущества:

- Оперативные поставки широкого спектра электронных компонентов отечественного и импортного производства напрямую от производителей и с крупнейших мировых складов;
- Поставка более 17-ти миллионов наименований электронных компонентов;
- Поставка сложных, дефицитных, либо снятых с производства позиций;
- Оперативные сроки поставки под заказ (от 5 рабочих дней);
- Экспресс доставка в любую точку России;
- Техническая поддержка проекта, помощь в подборе аналогов, поставка прототипов;
- Система менеджмента качества сертифицирована по Международному стандарту ISO 9001;
- Лицензия ФСБ на осуществление работ с использованием сведений, составляющих государственную тайну;
- Поставка специализированных компонентов (Xilinx, Altera, Analog Devices, Intersil, Interpoint, Microsemi, Aeroflex, Peregrine, Syfer, Eurofarad, Texas Instrument, Miteq, Cobham, E2V, MA-COM, Hittite, Mini-Circuits, General Dynamics и др.);

Помимо этого, одним из направлений компании «ЭлектроПласт» является направление «Источники питания». Мы предлагаем Вам помощь Конструкторского отдела:

- Подбор оптимального решения, техническое обоснование при выборе компонента;
- Подбор аналогов;
- Консультации по применению компонента;
- Поставка образцов и прототипов;
- Техническая поддержка проекта;
- Защита от снятия компонента с производства.



Как с нами связаться

Телефон: 8 (812) 309 58 32 (многоканальный)

Факс: 8 (812) 320-02-42

Электронная почта: org@eplast1.ru

Адрес: 198099, г. Санкт-Петербург, ул. Калинина, дом 2, корпус 4, литера А.