

LCL Series



- Single Output Industrial Supplies
- High Efficiency
- Low Cost
- 150 W Convection Cooled
- 300 W & 500 W with Internal Fans
- Outputs form 12 V to 48 V
- 3 Year Warranty

The LCL series is a low cost chassis mount product that is popular in industrial applications. The AC/DC supplies are enclosed in a metal case with terminal block input and output connectors. Three series offer 150, 300 and 500 Watts. Each power range includes six single output models from 12 to 48 VDC. The user adjustable outputs cover all nominal voltage ranges. The LCL150 is convection cooled while the 300 and 500 Watt have internal fans.

All LCL models are approved to ITE (60950-1) safety standards and meet EN55022 Level B conducted emissions. Operating temperature range is from -10 °C to +70 °C with derating above +50 °C. Standard features include overvoltage, overload, short circuit, and over temperature protection. Remote sense is included on the LCL500 with Remote On/Off available with the LCL300 and LCL500.

Models and Ratings

| Output Power | Output Voltage | Trim Range | Output Current | Ripple & Noise ⁽¹⁾ | Model Number |
|--------------|----------------|-------------|----------------|-------------------------------|--------------|
| 150 W | 12.0 V | 11.0-13.0 V | 12.5 A | 100 mV pk-pk | LCL150PS12 |
| | 13.5 V | 12.5-14.5 V | 11.1 A | 100 mV pk-pk | LCL150PS13 |
| | 15.0 V | 14.0-16.0 V | 10.0 A | 100 mV pk-pk | LCL150PS15 |
| | 24.0 V | 23.0-25.0 V | 6.3 A | 150 mV pk-pk | LCL150PS24 |
| | 27.0 V | 26.0-28.0 V | 5.6 A | 150 mV pk-pk | LCL150PS27 |
| | 48.0 V | 47.0-49.0 V | 3.1 A | 250 mV pk-pk | LCL150PS48 |
| 300 W | 12.0 V | 11.0-13.0 V | 25.0 A | 150 mV pk-pk | LCL300PS12 |
| | 13.5 V | 12.5-14.5 V | 22.0 A | 150 mV pk-pk | LCL300PS13 |
| | 15.0 V | 14.0-16.0 V | 20.0 A | 150 mV pk-pk | LCL300PS15 |
| 310 W | 24.0 V | 23.0-25.0 V | 13.0 A | 150 mV pk-pk | LCL300PS24 |
| 315 W | 27.0 V | 26.0-28.0 V | 11.7 A | 200 mV pk-pk | LCL300PS27 |
| 320 W | 48.0 V | 47.0-49.0 V | 6.70 A | 240 mV pk-pk | LCL300PS48 |
| 500 W | 12.0 V | 11.0-13.0 V | 42.0 A | 120 mV pk-pk | LCL500PS12 |
| | 13.5 V | 12.5-14.5 V | 37.0 A | 150 mV pk-pk | LCL500PS13 |
| | 15.0 V | 14.0-16.0 V | 34.0 A | 150 mV pk-pk | LCL500PS15 |
| | 24.0 V | 23.0-25.0 V | 21.0 A | 150 mV pk-pk | LCL500PS24 |
| | 27.0 V | 26.0-28.0 V | 18.5 A | 150 mV pk-pk | LCL500PS27 |
| | 48.0 V | 47.0-49.0 V | 10.5 A | 240 mV pk-pk | LCL500PS48 |

Notes: _____

1. Measured with 20 MHz bandwidth.

Input Characteristics

| Characteristic | Minimum | Typical | Maximum | Units | Notes & Conditions |
|---------------------------|-------------------------------------|---------|-------------------|-------|--|
| Input Voltage - Operating | 85 | | 264 | VAC | Derate output power < 90 VAC. See fig. 1. |
| Input Frequency | 47 | | 63 | Hz | |
| Power Factor | | >0.9 | | | EN61000-3-2 class A compliant LCL150: EN61000-3-2 class C for loads ≥40% LCL300 & LCL500: EN61000-3-2 class C for loads ≥40% |
| Input Current - Full Load | | | 2.1 4.5 6.6 | A | LCL150 at 90 VAC LCL300 at 90 VAC LCL500 at 90 VAC |
| Inrush Current | | | 50 60 | A | LCL150, 230 VAC, cold start 25 °C LCL300 & LCL500, 230 VAC, cold start 25 °C |
| Earth Leakage Current | | | <2 | mA | 264 VAC/60 Hz |
| Input Protection | T3.15 A/250 V internal in-line fuse | | | | LCL150 |
| | T6.3 A/250 V internal in-line fuse | | | | LCL300 |
| | T10 A/250 V internal in-line fuse | | | | LCL500 |

Input Derating Curve

Figure 1

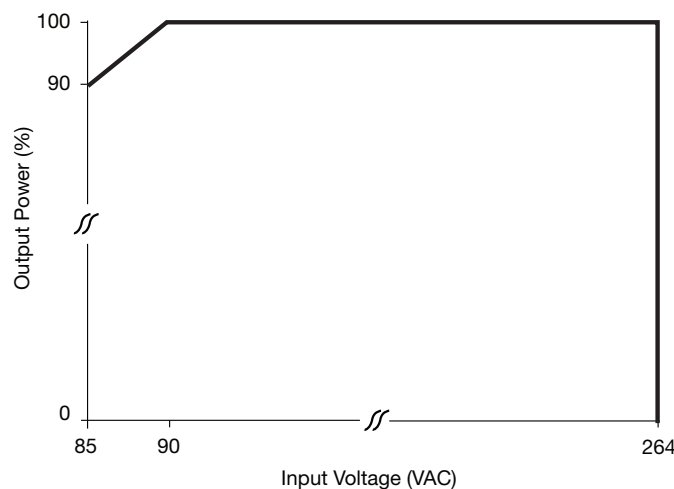

Output Characteristics

| Characteristic | Minimum | Typical | Maximum | Units | Notes & Conditions |
|----------------------------|---------|---------|---------|-------|--|
| Output Voltage - V1 | 12 | | 48 | VDC | See Models and Ratings table |
| Initial Set Accuracy | | | ±100 | mV | 50% load |
| Output Voltage Adjustment | ±1 | | | V | See Models and Ratings table |
| Minimum Load | 0 | | | A | |
| Start Up Delay | | | 2 | s | |
| Start Up Rise Time | | | 65 | ms | LCL150 |
| | | | 80 | | LCL300 |
| | | | 35 | | LCL500 |
| Hold Up Time | 10 | | | ms | 115 VAC full load |
| Line Regulation | | | ±0.5 | % | LCL150 |
| | | | ±0.3 | | LCL300 & LCL500 |
| Load Regulation | | | ±1 | % | |
| Transient Response | | | 4 | % | Recovery within 1% in less than 500 μ s for a 50% load change |
| Ripple & Noise | | | | | See Models and Ratings table |
| Overvoltage Protection | 110 | | 140 | % | Recycle input to reset |
| Overload Protection | 110 | | 150 | % | Rated output power, delayed by 1 s minimum to allow peak loads. See fig 2, 3 & 4 |
| Short Circuit Protection | | | | | Auto recovery, hiccup mode |
| Overtemperature Protection | | | | | Output turns off when OTP triggered, measured internally (Q1 temperature), auto recover when internal temperature was reduced. |

Output Overload Characteristics

Figure 2 - LCL150PS12

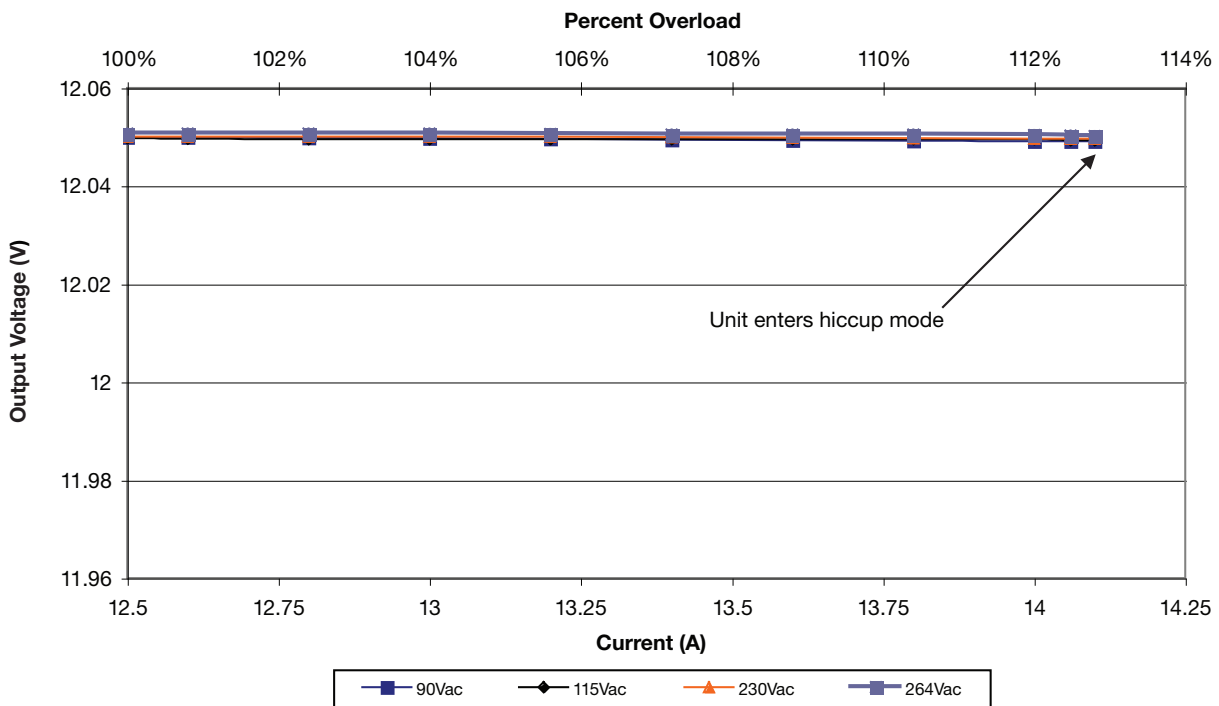

Output Overload Characteristics

Figure 3 - LCL300PS24

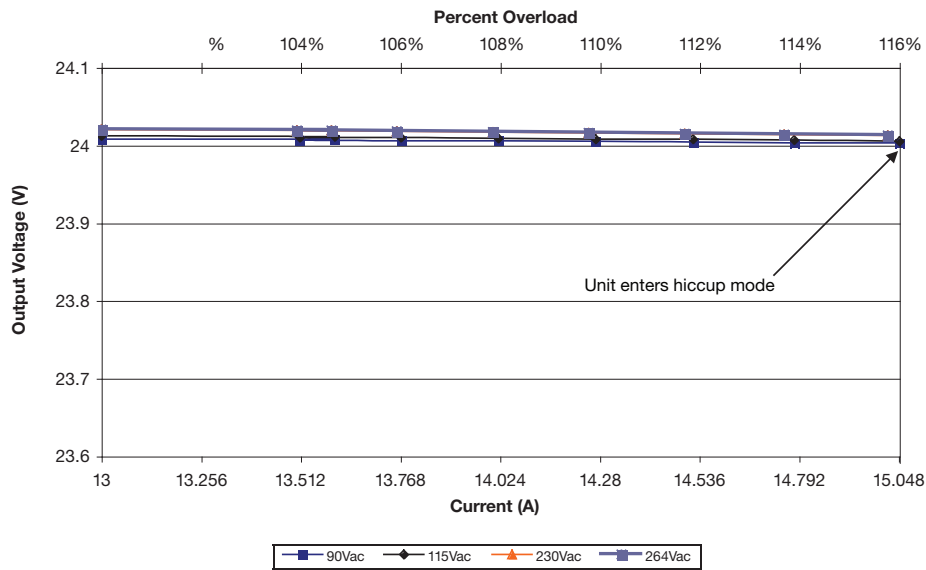
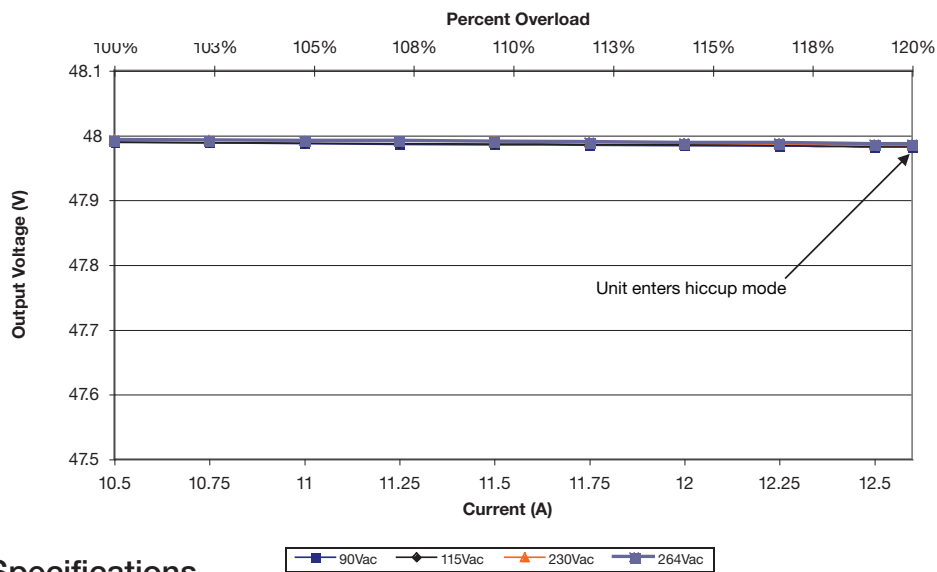

Figure 4 - LCL500PS48



General Specifications

| Characteristic | Minimum | Typical | Maximum | Units | Notes & Conditions |
|---|---------|---------|------------|-------------------|-------------------------------------|
| Efficiency | 85 | 88 | | % | 230 VAC full load, See fig 5, 6 & 7 |
| Isolation: Input to Output Input to Ground Output to Ground | 3000 | | | VAC | |
| | 1500 | | | | |
| | 500 | | | | |
| Switching Frequency | 45 | | 190 | kHz | PFC Converter |
| | 90 | | 110 | | Main Converter |
| | 62 | | 65 | | PFC Converter |
| | 80 | | 190 | | Main converter |
| Power Density | | | 2.7 | W/in ³ | LCL150 |
| | | | 4.4 | | LCL300 |
| | | | 4.9 | | LCL500 |
| MTBF | | 200 | | kHrs | MIL-HDBK-217F at 25 °C, GB |
| Weight | | | 1.39 (630) | lb (g) | LCL150 |
| | | | 1.94 (880) | lb (g) | LCL300 |
| | | | 3.2 (1.45) | lb (kg) | LCL500 |
| | | | | | See mechanical details |

Efficiency vs Load

Figure 5 - LCL150PS12

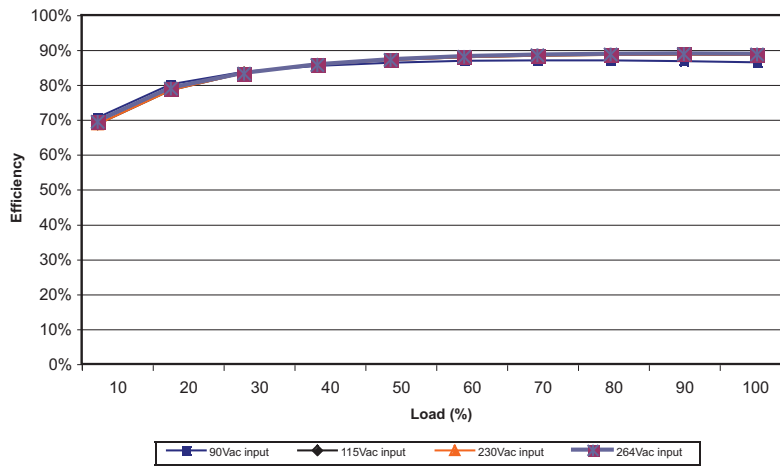

Figure 6 - LCL300PS24

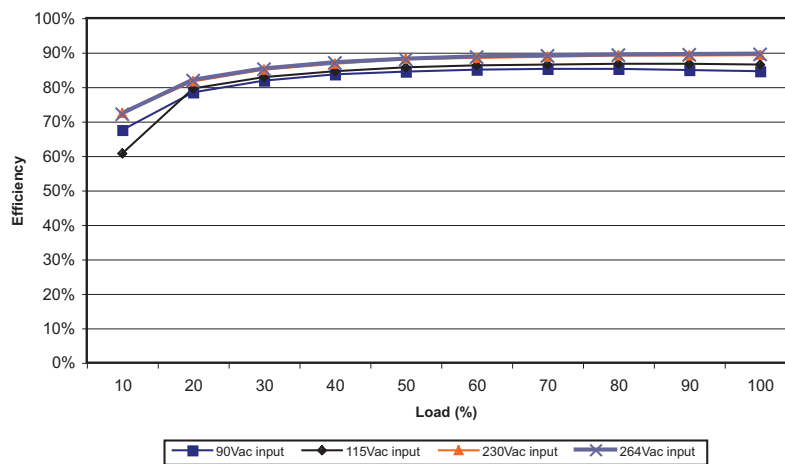
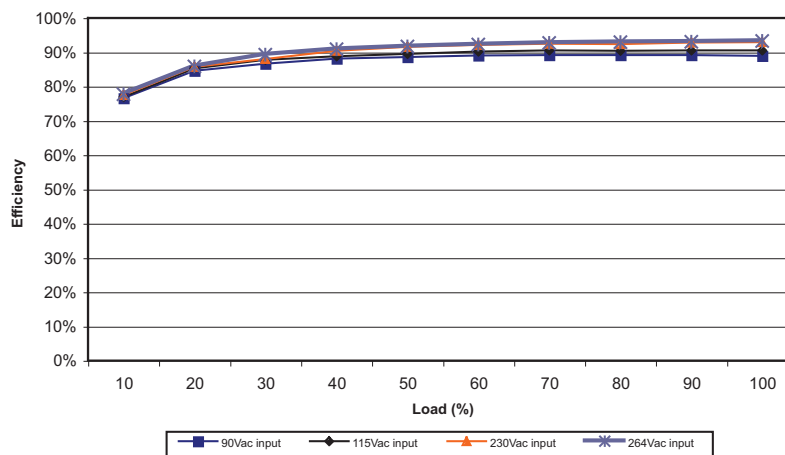

Figure 7 - LCL500PS48



Signals & Controls

| Characteristics | Notes and Conditions |
|-----------------|--|
| Remote Sense | Compensates for 0.25 V max each line. Fitted to LCL500 only. |
| Remote On/Off | Fitted on LCL500. On = logic low or open circuit, OFF = logic high |

Figure 8 - Remote Sense Connection Diagram

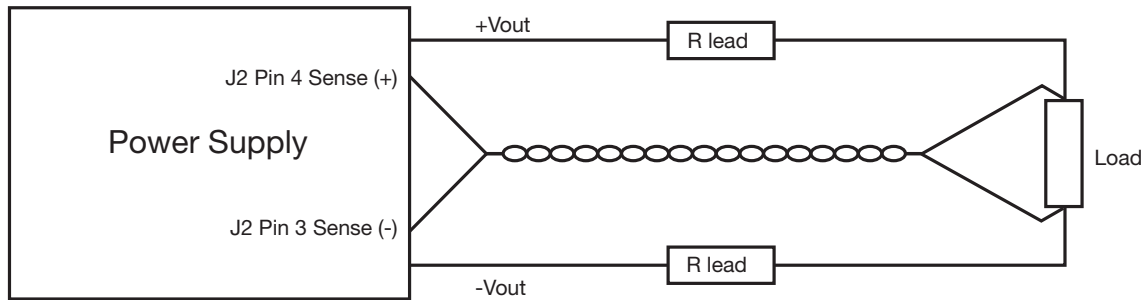
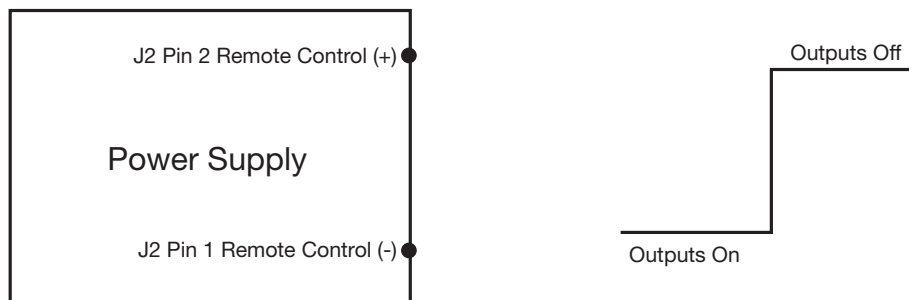

Figure 9 - Remote On/Off



1. Applying $<0.8\text{ V}$ on Pin 2 with respect to Pin 1 or open circuit, output turns ON.
2. Applying $>4.5\text{ V}$ on Pin 2 with respect to Pin 1, output turns OFF

Environmental

| Characteristic | Minimum | Typical | Maximum | Units | Notes & Conditions |
|-----------------------|---------|---------|---------|-------|--|
| Operating Temperature | -10 | | 70 | °C | LCL150 & LCL300: Derates linearly from 100% load at 50 °C to 50% load at 70 °C (see fig 10). At -10 °C, 90 VAC, start up time increases to 4 s (LCL150) LCL500: Derates linearly from 100% load at 55 °C to 50% load at 70 °C (see fig. 11). At -10 °C, 90 VAC, start up time increases to 5 s. |
| Storage Temperature | -40 | | 85 | °C | |
| Cooling | | | | | LCL150 convection cooled, LCL300 & LCL500 have internal fans. |
| Humidity | 5 | | 95 | %RH | Non-condensing |
| Operating Altitude | | | 3000 | m | |
| Vibration | 2 | | | g | 10-500 Hz, 10 mins per cycle on 3 axes |

Temperature Derating Curve

Figure 10 - LCL150 & LCL300

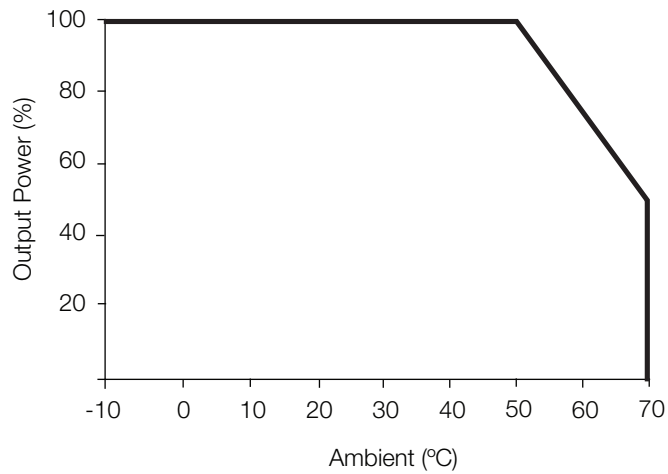
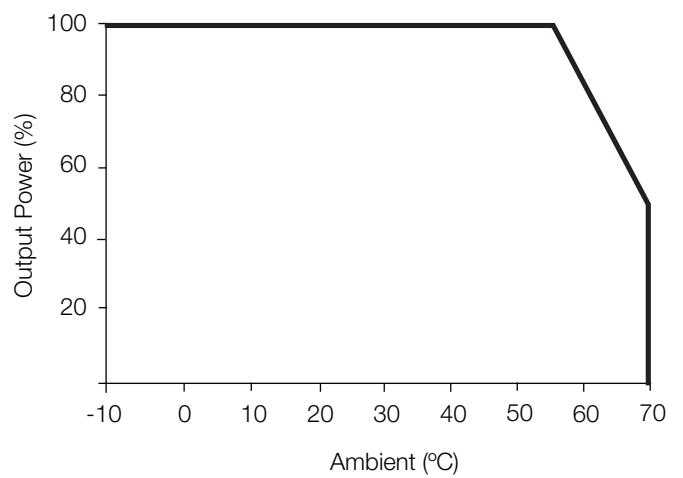

Figure 11 - LCL500



Electromagnetic Compatibility - Immunity (high severity level, EN61204-3)

| Phenomenon | Standard | Test Level | Criteria | Notes & Conditions |
|------------------------|--------------|----------------------|----------|--------------------------|
| ESD | EN61000-4-2 | ±4 kV | A | Contact Discharge |
| | | ±8 kV | | Air Discharge |
| | | ±8 kV | | Coupling Plane Discharge |
| Radiated RF | EN61000-4-3 | 2 | A | |
| EFT | EN61000-4-4 | 2 | A | |
| Surge | EN61000-4-5 | Installation Class 3 | A | LCL150 & LCL300 |
| | | Installation Class 2 | | LCL500 |
| Conducted RF | EN61000-4-6 | 2 | A | |
| Magnetic Field | EN61000-4-8 | 1 A/m | A | |
| Dips and Interruptions | EN61000-4-11 | Dip: 30% 10 ms | A | |
| | | Dip: 60% 100 ms | B | |
| | | Dip: 100% 5000 ms | B | |

ESD Points

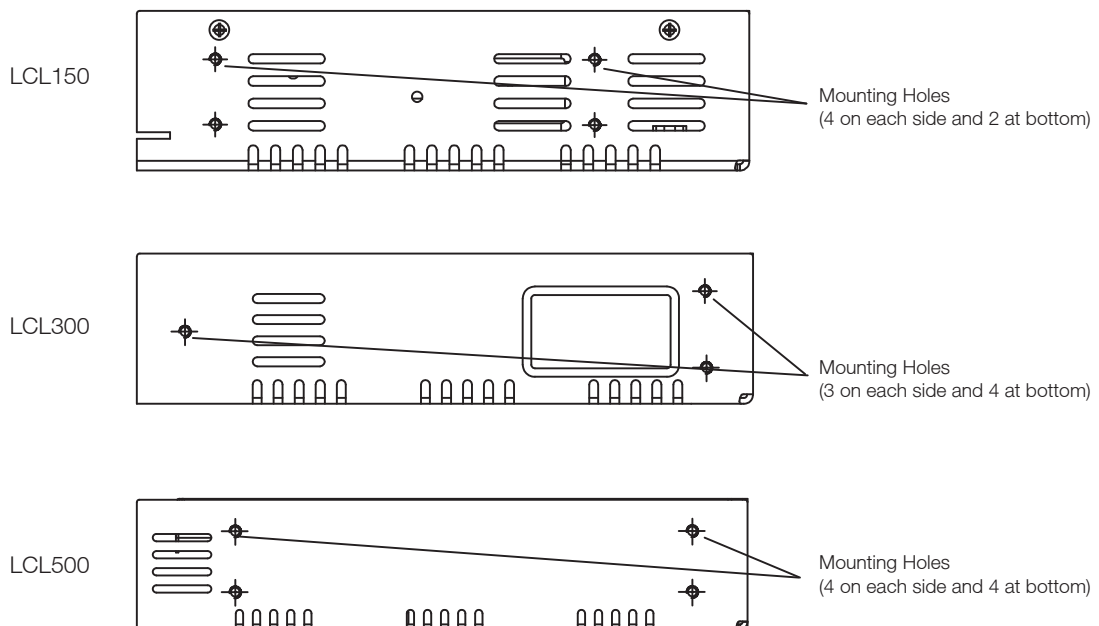

10 discharges at each polarity were applied at points indicated (contact and air discharges)

Electromagnetic Compatibility - Emissions

| Phenomenon | Standard | Test Level | Criteria | Notes & Conditions |
|-------------------|-------------|-------------------|----------|--------------------|
| Conducted | EN55022 | Class B | | |
| Radiated | EN55022 | Class A | | |
| Harmonic Currents | EN61000-3-2 | Class A Equipment | | |

Conducted Emission Plots

Figure 15 - QP Detector - LCL150PS12

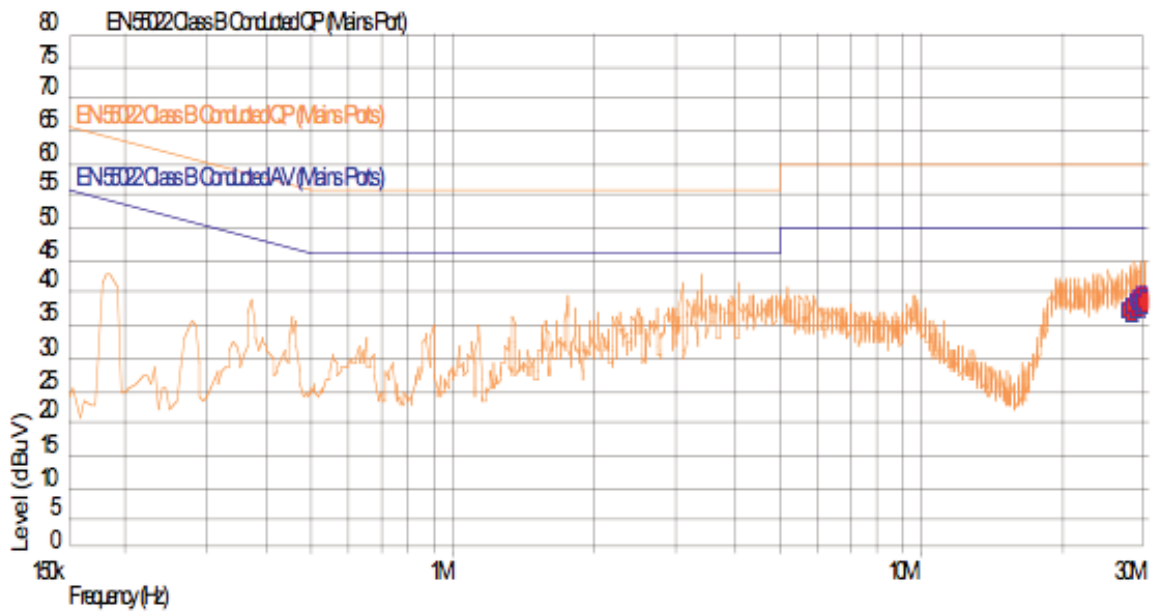
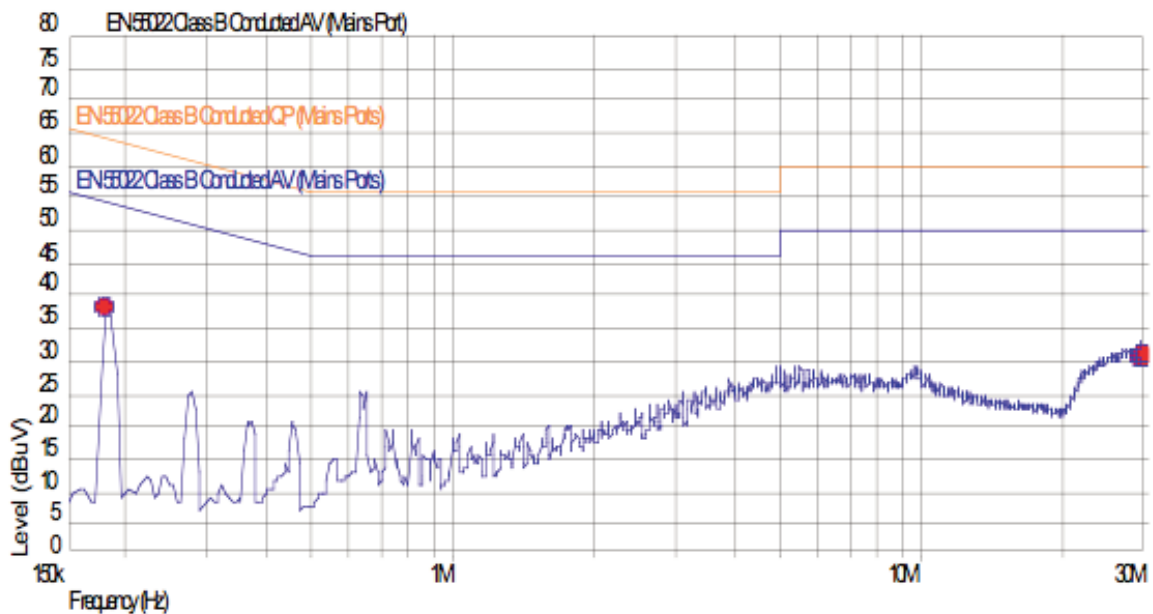

Figure 15 - AV Detector - LCL150PS12



Conducted Emission Plots

Figure 16 - QP Detector - LCL300PS24

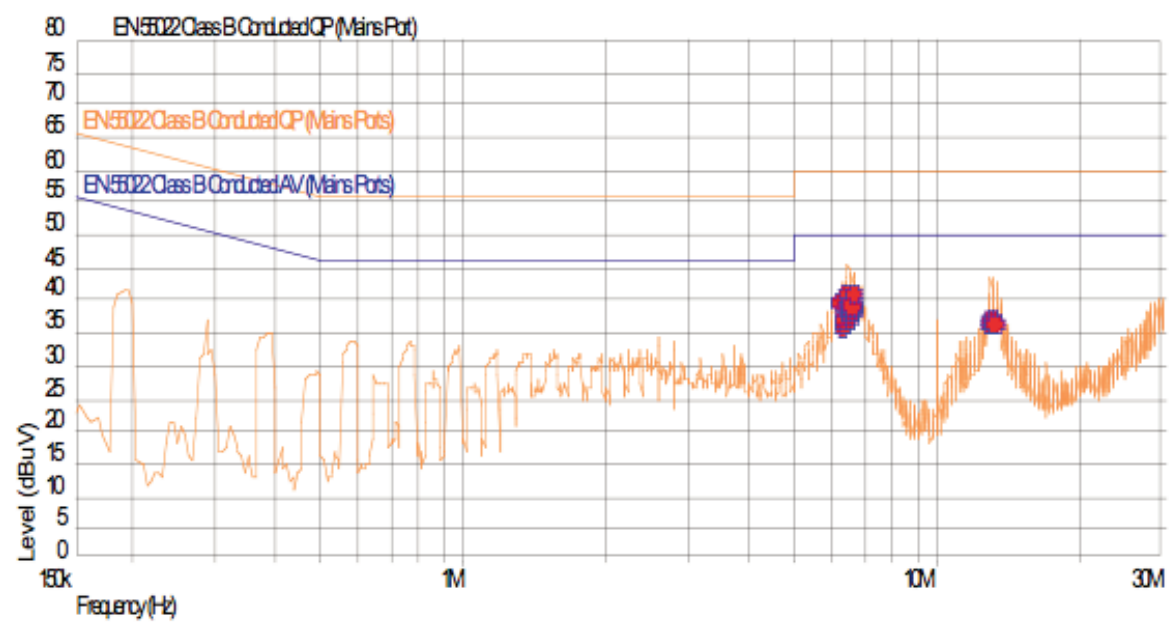
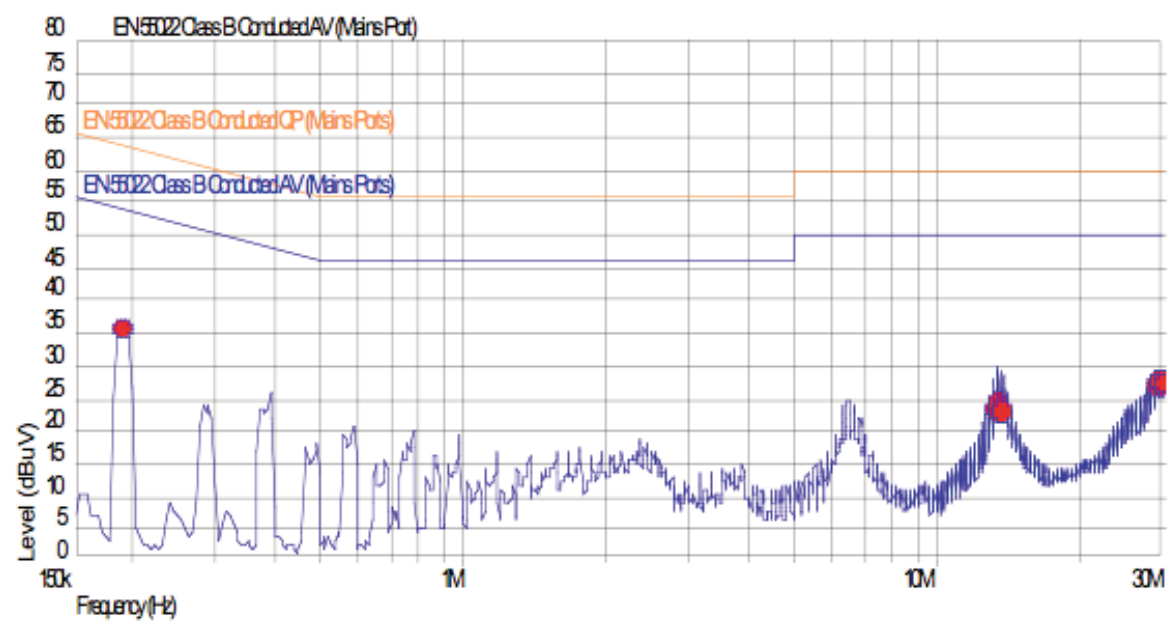

Figure 16 - AV Detector - LCL300PS24



Conducted Emission Plots

Figure 17 - QP Detector - LCL500PS48

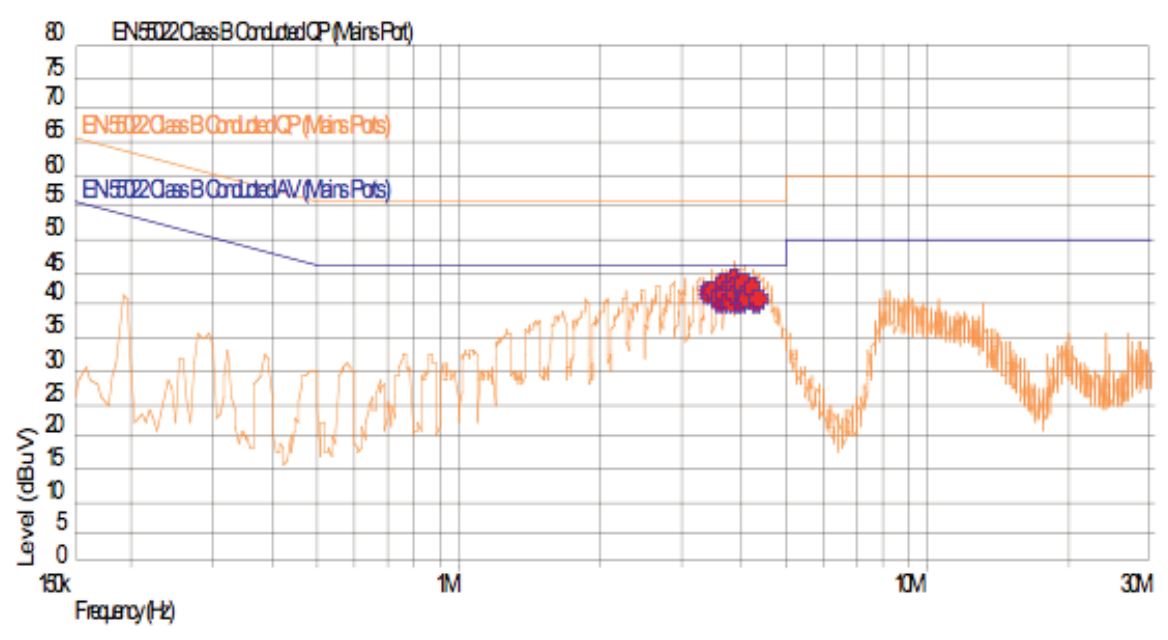
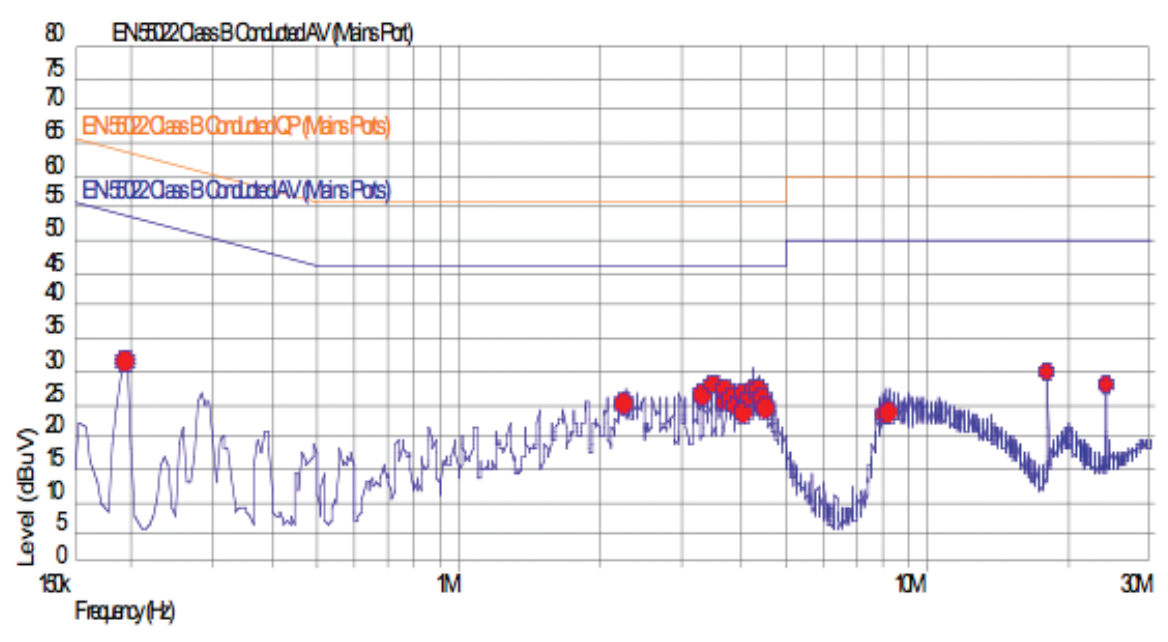

Figure 17 - AV Detector - LCL500PS48



Safety Agency Approvals

| Safety Agency | Safety Standard | Category | |
|---------------|---|------------------------|--------|
| CB Report | US/14041/UL IEC 60950-1 (2005) Ed 2 E139109-A27-CB-1 | Information Technology | LCL150 |
| | US/14236/UL IEC 60950-1 (2005) Ed 2 E139109-A29-CB-1 | | LCL300 |
| | US/14254/UL IEC 60950-1 (2005) Ed 2 E139109-A28-CB-1 | | LCL500 |
| UL | UL File #E139109 UL60950-1(2007) CSA 22.2 No. 60950-1-07 Ed 2 | Information Technology | |
| TUV | TUV Certificate #B09 07 57396 061 EN60950-1/A11:2009 | Information Technology | LCL150 |
| | TUV Certificate #B09 07 57396 062 EN60950-1/A11:2009 | | LCL300 |
| | TUV Certificate #B09 07 57396 063 EN60950-1/A11:2009 | | LCL500 |

| Equipment Protection Class | Safety Standard | Notes & Conditions |
|----------------------------|-----------------------|---|
| Class I | IEC 60950-1:2005 Ed 2 | See safety agency conditions of acceptability for details |

Mechanical Details - LCL150

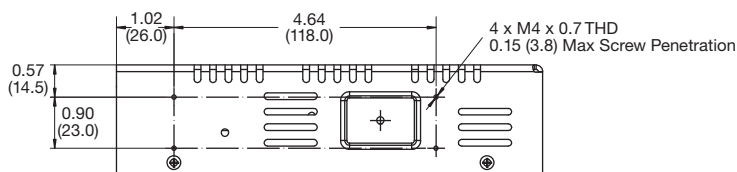
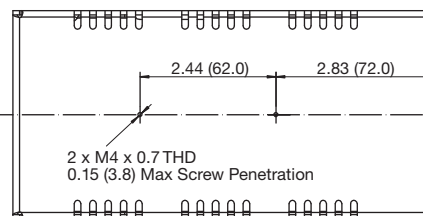
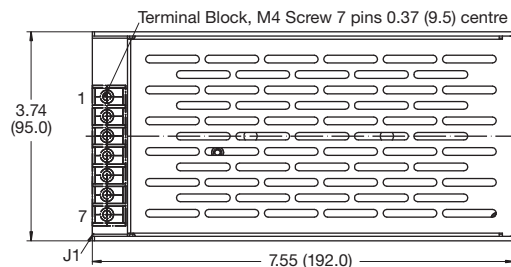
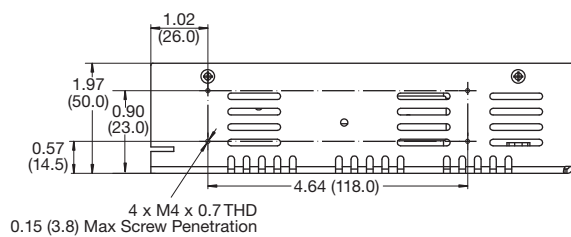

| Pin | Function |
|-----|------------|
| 1 | +Vout |
| 2 | +Vout |
| 3 | -Vout |
| 4 | -Vout |
| 5 | Ground |
| 6 | AC Neutral |
| 7 | AC Live |

Notes:

Weight: 1.39 lbs (630g) approx.
Dimensions shown in inches (mm).

Tolerance is ± 0.05 (± 0.2) maximum.

Mechanical Details - LCL300

Weight: 1.94 lbs (880g) approx.
 Dimensions shown in inches (mm).
 Tolerance is ± 0.05 (± 0.2) maximum.
 Airflow direction is out of the unit at fan.

| J1 Pin Connections | |
|--------------------|------------|
| Pin | Function |
| 1 | +Vout |
| 2 | +Vout |
| 3 | +Vout |
| 4 | -Vout |
| 5 | -Vout |
| 6 | -Vout |
| 7 | Ground |
| 8 | AC Neutral |
| 9 | AC Live |

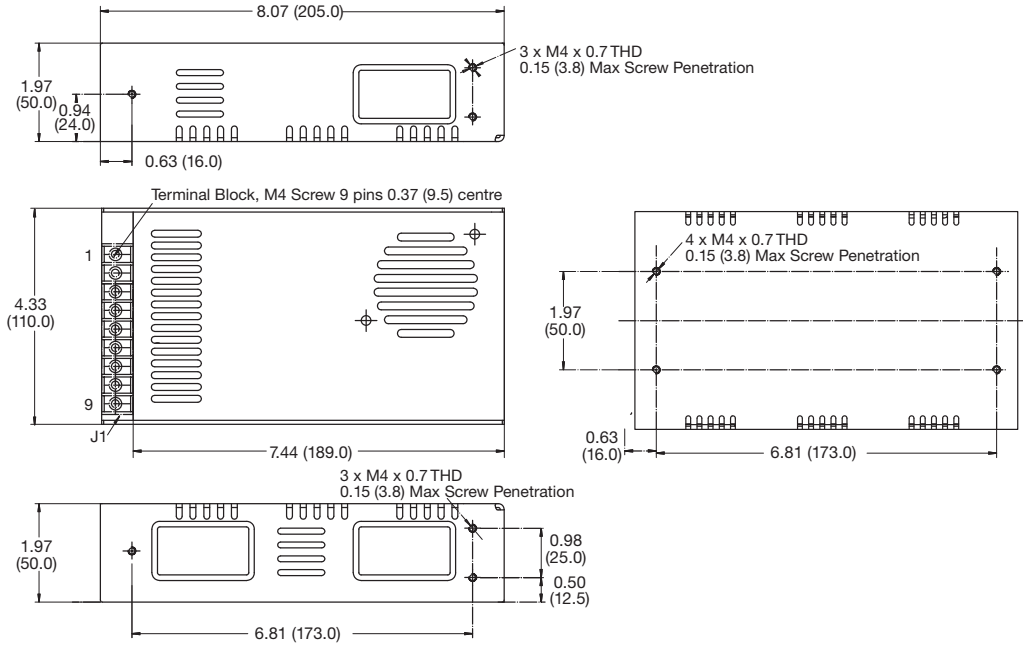

LCL500

Weight: 3.2 lbs (1.45 kg) approx.
 Dimensions shown in inches (mm).
 Tolerance is ± 0.05 (± 0.2) maximum.

| J1 Pin Connections | |
|--------------------|------------|
| Pin | Function |
| 1 | +Vout |
| 2 | +Vout |
| 3 | +Vout |
| 4 | -Vout |
| 5 | -Vout |
| 6 | -Vout |
| 7 | Ground |
| 8 | AC Neutral |
| 9 | AC Live |

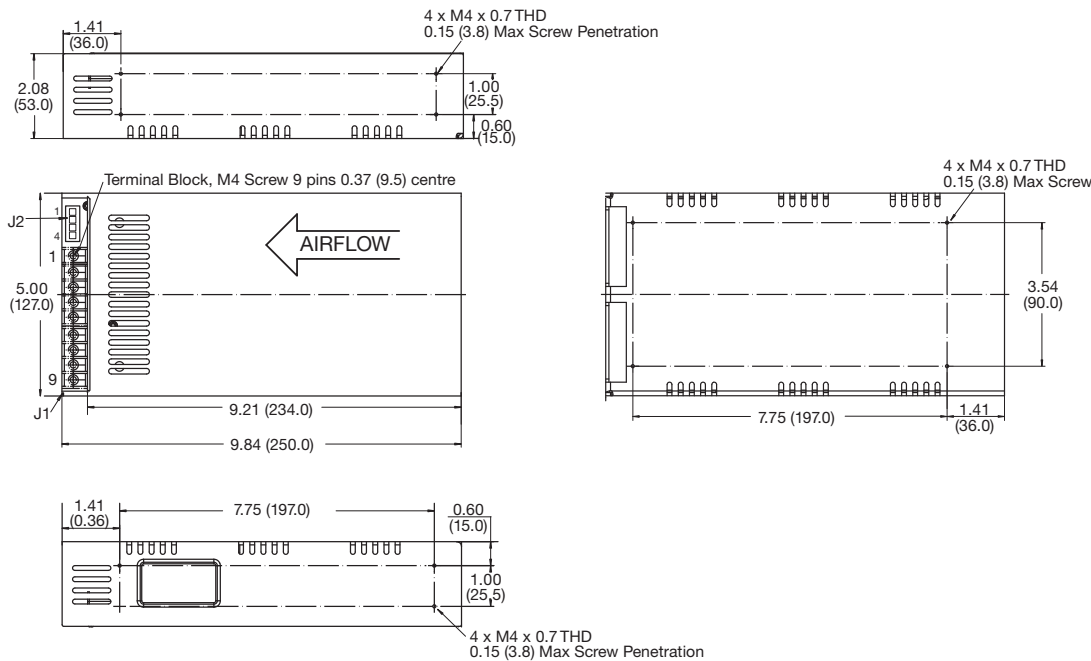

| J2 Pin Connections | |
|--------------------|------------------|
| Pin | Function |
| 1 | Remote Control - |
| 2 | Remote Control + |
| 3 | Sense - |
| 4 | Sense + |

Applying $>4.5V$ to Pin 2 with respect to Pin 1 turns output off.
 Applying $<0.8V$ to Pin 2 with respect to Pin 1 or open circuit turns output on.

Mating Connectors (J2):
 WST P4-I25002 housing
 WST I25002BS contacts



Компания «ЭлектроПласт» предлагает заключение долгосрочных отношений при поставках импортных электронных компонентов на взаимовыгодных условиях!

Наши преимущества:

- Оперативные поставки широкого спектра электронных компонентов отечественного и импортного производства напрямую от производителей и с крупнейших мировых складов;
- Поставка более 17-ти миллионов наименований электронных компонентов;
- Поставка сложных, дефицитных, либо снятых с производства позиций;
- Оперативные сроки поставки под заказ (от 5 рабочих дней);
- Экспресс доставка в любую точку России;
- Техническая поддержка проекта, помощь в подборе аналогов, поставка прототипов;
- Система менеджмента качества сертифицирована по Международному стандарту ISO 9001;
- Лицензия ФСБ на осуществление работ с использованием сведений, составляющих государственную тайну;
- Поставка специализированных компонентов (Xilinx, Altera, Analog Devices, Intersil, Interpoint, Microsemi, Aeroflex, Peregrine, Syfer, Eurofarad, Texas Instrument, Miteq, Cobham, E2V, MA-COM, Hittite, Mini-Circuits, General Dynamics и др.);

Помимо этого, одним из направлений компании «ЭлектроПласт» является направление «Источники питания». Мы предлагаем Вам помощь Конструкторского отдела:

- Подбор оптимального решения, техническое обоснование при выборе компонента;
- Подбор аналогов;
- Консультации по применению компонента;
- Поставка образцов и прототипов;
- Техническая поддержка проекта;
- Защита от снятия компонента с производства.



Как с нами связаться

Телефон: 8 (812) 309 58 32 (многоканальный)

Факс: 8 (812) 320-02-42

Электронная почта: org@eplast1.ru

Адрес: 198099, г. Санкт-Петербург, ул. Калинина, дом 2, корпус 4, литера А.