

Features

- 2MOPP, 250VAC working voltage isolation
- Clearance and creepage distance >8mm
- Up to 10kVDC reinforced insulation
- IEC/EN/UL 60601 certified with CB Report (3rd Ed. Safety, 4th Ed. EMC)
- -40°C to +85°C operation, no derating
- 2:1 wide input range

Regulated Converter



REM3.5E

3.5 Watt
2:1 Input
DIP24 or SMD
Single & Dual
Output



Description

The REM3.5E series of medical grade regulated DC/DC converters feature reinforced 250VAC continuous working isolation with >8mm creepage/clearance. The compact DIP24/SMD package offers industry standard pinouts with tightly regulated single/dual outputs and UVLO, SCP and OCP. The operating ambient temperature range is from -40°C to +85°C without derating. The converters are UL marked and certified to CB, IEC, EN and ANSI/AAMI 60601 3rd. Ed. Safety and 4th Ed. EMC medical standards. The low 1µA leakage current complies with medical applied part B, BF and CF limits as defined by IEC60601-1.

Selection Guide

Part Number	nom. Input Voltage [VDC]	Output Voltage [VDC]	Output Current [mA]	Efficiency typ. ⁽¹⁾ [%]	Max. Capacitive Load ⁽²⁾ [µF]
REM3.5E-xx05S/R ⁽³⁾ /A ^(4,5)	5 / 12 / 24 / 48	5	700	76 / 80 / 81 / 82	4700
REM3.5E-xx09S/R ⁽³⁾ /A ^(4,5)	5 / 12 / 24 / 48	9	388	80 / 81 / 82 / 82	3300
REM3.5E-xx12S/R ⁽³⁾ /A ^(4,5)	5 / 12 / 24 / 48	12	290	82 / 82 / 83 / 82	2200
REM3.5E-xx15S/R ⁽³⁾ /A ^(4,5)	5 / 12 / 24 / 48	15	233	83 / 82 / 84 / 83	2200
REM3.5E-xx24S/R ⁽³⁾ /A ^(4,5)	5 / 12 / 24 / 48	24	145	82 / 82 / 84 / 83	1000
REM3.5E-xx05D/R ⁽³⁾ /A ^(4,5)	5 / 12 / 24 / 48	±5	±350	76 / 80 / 81 / 82	±2200
REM3.5E-xx09D/R ⁽³⁾ /A ^(4,5)	5 / 12 / 24 / 48	±9	±194	80 / 81 / 82 / 82	±1600
REM3.5E-xx12D/R ⁽³⁾ /A ^(4,5)	5 / 12 / 24 / 48	±12	±145	82 / 82 / 83 / 82	±1000
REM3.5E-xx15D/R ⁽³⁾ /A ^(4,5)	5 / 12 / 24 / 48	±15	±117	83 / 82 / 84 / 83	±1000

Notes:

- Note1: Efficiency is tested at nominal input and full load at +25°C ambient
 Note2: Max Cap Load is tested at nominal input and full resistive load



CAN/CSA-C22.2 No. 60601-1:14 certified
 ANSI/AAMI ES60601-1 certified
 EN60601-1 certified
 IEC60601-1 certified
 IEC60601-1-2 compliant
 EN55032 compliant

Model Numbering



Notes:

- Note3: add suffix „/R8“ for 8kVDC or „/R10“ for 10kVDC isolation (DIP24 only)
 if SMD package is used, always add suffix „/R6“ for 6kVDC isolation
 Note4: add suffix „/CTRL“ for fitted CTRL pin (DIP24 only)
 if SMD package is used do not add suffix „/CTRL“, CTRL pin is always mounted
 Note5: add suffix „/X1“ for Under Voltage Lockout Option

Specifications (measured @ Ta= 25°C, nom. Vin, full load and after warm-up unless otherwise stated)

BASIC CHARACTERISTICS					
Parameter	Condition		Min.	Typ.	Max.
Internal Input Filter					Pi-type
Input Voltage Range	nom. Vin = 5VDC nom. Vin = 12VDC nom. Vin = 24VDC nom. Vin = 48VDC		4.5VDC 9VDC 18VDC 36VDC	5VDC 12VDC 24VDC 48VDC	9VDC 18VDC 36VDC 75VDC
Under Voltage Lockout (UVLO) ("X1" version)	nom. Vin= 5VDC	DC-DC ON DC-DC OFF		3.9VDC	4.5VDC
	nom. Vin= 12VDC	DC-DC ON DC-DC OFF		7.9VDC	9VDC
	nom. Vin= 24VDC	DC-DC ON DC-DC OFF		16.7VDC	18VDC
	nom. Vin= 48VDC	DC-DC ON DC-DC OFF		34.3VDC	36VDC
Input Current	nom. Vin = 5VDC nom. Vin = 12VDC nom. Vin = 24VDC nom. Vin = 48VDC			900mA 360mA 180mA 90mA	
Quiescent Current	nom. Vin = 5VDC nom. Vin = 12VDC nom. Vin = 24VDC nom. Vin = 48VDC				50mA 20mA 5mA 2.5mA
Minimum Load ⁽⁷⁾				10%	
Start-up time				0.6ms	
Rise time				0.45ms	
Hold-up time				0.6ms	
ON/OFF CTRL	DC-DC ON DC-DC OFF		Open or 0VDC < V _{CTRL} < 1.2VDC Short or 4.8VDC < V _{CTRL} < 12VDC		
Input Current of CTRL Pin	V _{CTRL} = 5VDC			25mA	
Standby Current	DC-DC OFF				350µA
Intvernal Operating Frequency			120kHz		
Output Ripple and Noise ⁽⁶⁾	20MHz BW				150mVp-p

Notes:

Note6: Measurements are made with a 0.1µF MLCC across output. (low ESR)

ON/OFF CTRL Option

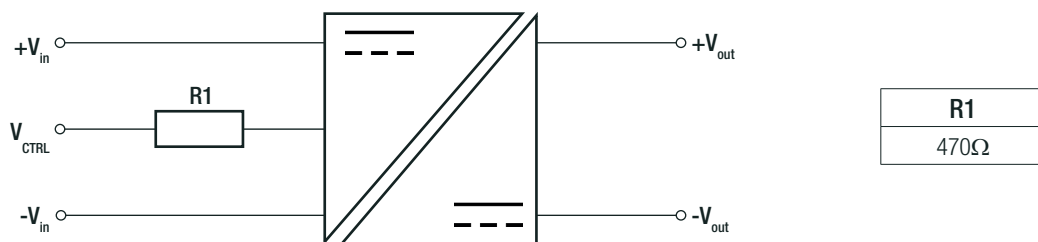

continued on next page

Specifications (measured @ Ta= 25°C, nom. Vin, full load and after warm-up unless otherwise stated)

Efficiency vs. Output Load

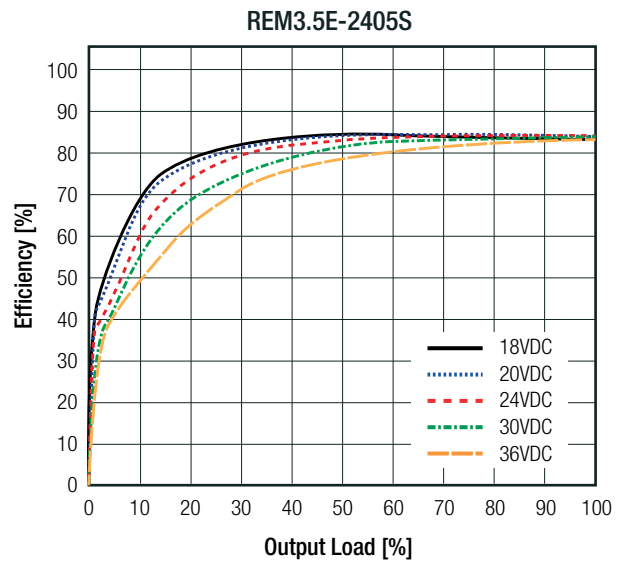
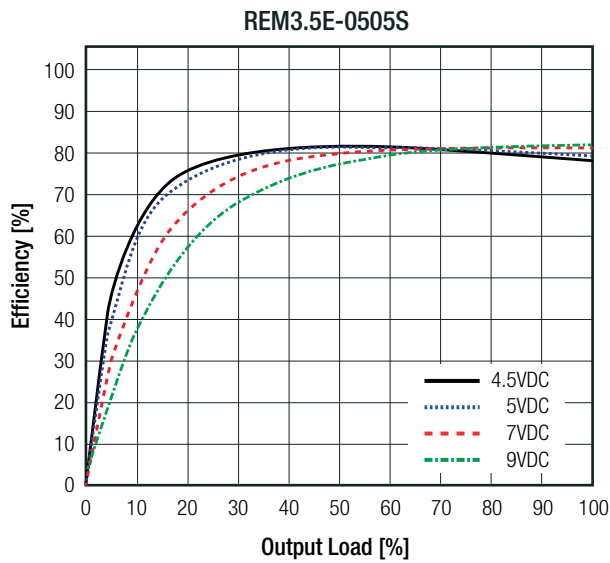

Efficiency vs. Input Voltage
(@ full Load)

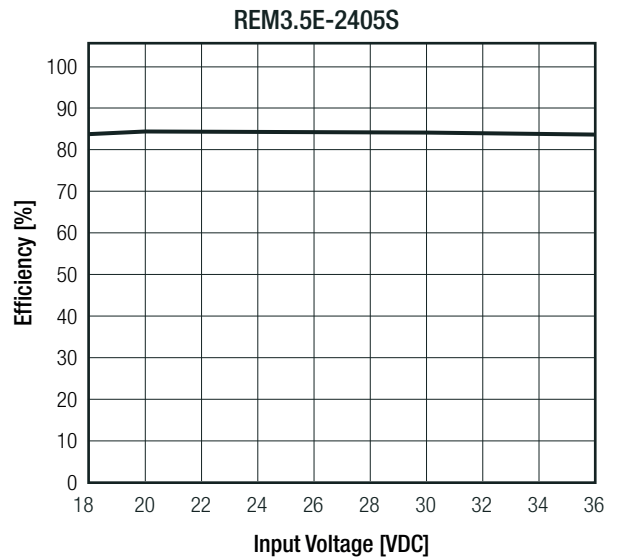
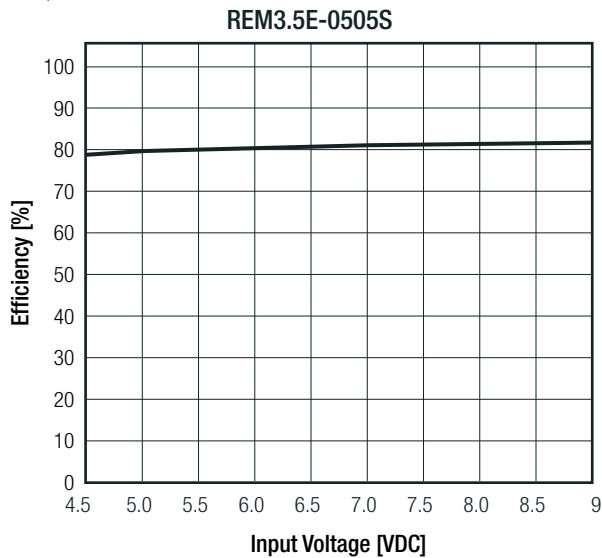

REGULATIONS

Parameter	Condition	Value
Output Accuracy		±1.5% typ.
Line Regulation	low line to high line, full load	±0.3% max.
Load Regulation ⁽⁷⁾	10% to 100% load	0.5% typ.
Cross Regulation	dual output only	±5.0% max.
Transient Response	25% load step change	5ms

Notes:

Note7: Operation below 10% load will not harm the converter, but specifications may not be met

continued on next page

Specifications (measured @ Ta= 25°C, nom. Vin, full load and after warm-up unless otherwise stated)

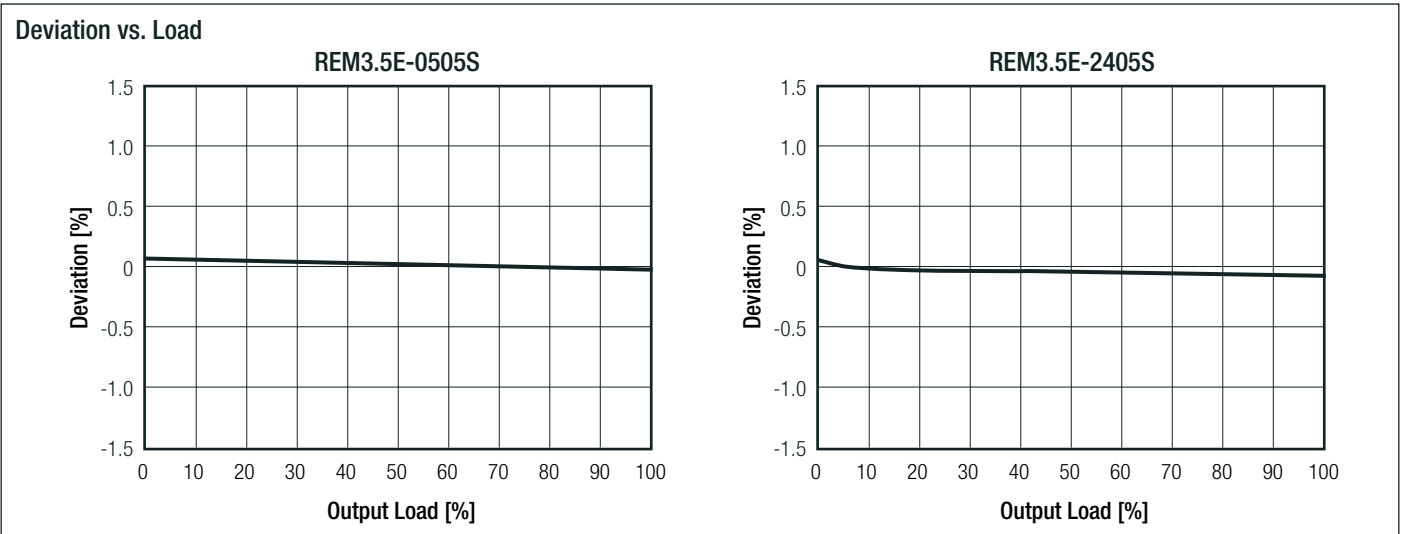

PROTECTIONS				
Parameter	Type			Value
Short Circuit Protection (SCP)	below 100mΩ			continuous, hiccup mode, automatic recovery
Isolation Voltage ⁽⁸⁾	I/P to O/P	DIP24	"/R8" suffix	tested for 1 second rated for 1 minute
			"/R10" suffix	tested for 1 second rated for 1 minute
		SMD	"/R6" suffix	rated for 1 minute
Isolation Resistance				10GΩ min.
Isolation Capacitance				20pF typ.
Insulation Grade				reinforced
Leakage Current				0.8μA typ. / 1μA max.
Means of Protection	250VAC working voltage			2MOPP
Medical Device Classification				built-in power supply
Internal	clearance/creepage			>8mm
External	clearance/creepage			>8mm
Notes:				
Note8: For repeat Hi-Pot testing, reduce the time and/or the test voltage				
Note9: Refer to local safety regulations if input over-current protection is also required. Recommended fuse: slow blow type				

ENVIRONMENTAL			
Parameter	Condition		Value
Operating Temperature Range	full load @ natural convection 0.1m/s (see graph)		-40°C to +85°C
Maximum Case Temperature			+105°C
Temperature Coefficient			±0.02%/K typ. / ±0.05%/K max.
Thermal Impedance	0.1m/s, horizontal		20K/W
Operating Altitude			3000m
Operating Humidity	non-condensing		5% - 95% RH max.
Pollution Degree			PD2
MTBF	according to MIL-HDBK-217F, G.B.	+25°C	3600 x 10 ³ hours
		+85°C	450 x 10 ³ hours
continued on next page			

Specifications (measured @ Ta= 25°C, nom. Vin, full load and after warm-up unless otherwise stated)

Derating Graph

(@ Chamber and natural convection 0.1m/s)

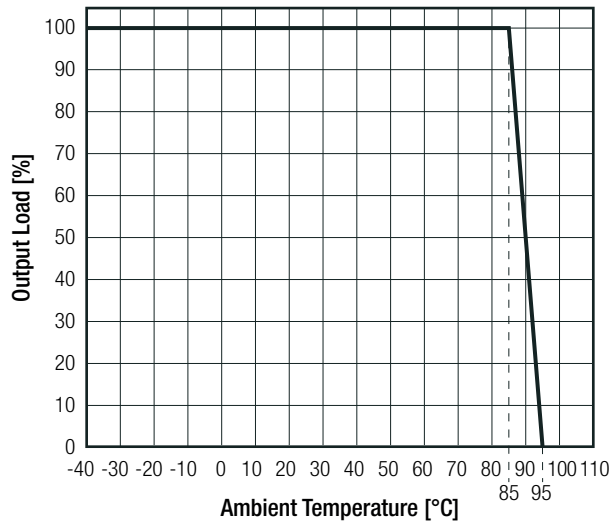

SAFETY AND CERTIFICATIONS

Certificate Type (Safety)	Report / File Number	Standard
Medical Electric Equipment, General Requirements for Safety and Essential Performance	E314885	CAN/CSA-C22.2 No. 60601-1:14, 3rd Edition: 2014 ANSI/AAMI ES60601-1:2012
Medical Electric Equipment, General Requirements for Safety and Essential Performance (CB Scheme)	E314885	IEC60601-1:2005, 3rd Edition + AM1:2012
Medical Electric Equipment, General Requirements for Safety and Essential Performance	WD-SE-R-180524-A0	EN60601-1:2006 + A12:2014 IEC60601-1:2005, 3rd Edition + AM1:2012
RoHS 2		RoHS 2011/65/EU + AM2015/863

EMC Compliance	Condition	Standard / Criterion
Information technology equipment - Radio disturbance characteristics - Limits and methods of measurement	with external filter refer to "EMC Filtering"	EN55032, Class A and B
Information technology equipment - Immunity characteristics - Limits and methods of measurement		EN55024:2010 + A1:2015
ESD Electrostatic discharge immunity test	Air ±8kV, Contact ±4kV	IEC61000-4-2:2009, Criteria A
Radiated, radio-frequency, electromagnetic field immunity test	3V/m	IEC61000-4-3:2006 + A2:2010, Criteria A
Fast Transient and Burst Immunity	DC Power Port: ±1kV	IEC61000-4-4:2012, Criteria A
Surge Immunity	DC Power (Output) Port: ±0.5kV	IEC61000-4-5:2014 + A1:2017, Criteria A
Immunity to conducted disturbances, induced by radio-frequency fields	DC Power (Output) Port: 3V	IEC61000-4-6:2013 + C1:2015, Criteria A
Power Magnetic Field Immunity	50Hz, 1A/m	IEC61000-4-8:2010, Criteria A
Medical electrical equipment Part 1-2: Electromagnetic disturbances – Requirements and tests	with external filter	EN60601-1-2:2015 IEC60601-1-2:2014
Industrial, scientific and medical equipment – Radio frequency disturbance characteristics – Limits and methods of measurement		EN55011:2016+A1:2017, Class B
ESD Electrostatic discharge immunity test	Air ±15kV, Contact ±8kV	IEC61000-4-2:2008, EN61000-4-2:2009
Radiated, radio-frequency, electromagnetic field immunity test	10V/m	IEC61000-4-3:2006+A1:2007+A2:2010 EN61000-4-3:202006+A2:2010
Fast Transient and Burst Immunity	DC Power Port: ±2kV	IEC/EN61000-4-4:2012
Surge Immunity	DC Power (Output) Port: ±1kV	IEC/EN61000-4-5:2014+A1:2017
Immunity to conducted disturbances, induced by radio-frequency fields	DC Power (Output) Port: 3V, 6V	IEC61000-4-6:2013, EN61000-4-6:2014
Power Magnetic Field Immunity	50Hz, 30A/m	IEC61000-4-8:2009, EN61000-4-8:2010

continued on next page

Specifications (measured @ Ta= 25°C, nom. Vin, full load and after warm-up unless otherwise stated)

EMC Filtering Suggestions according to EN55032

Class A

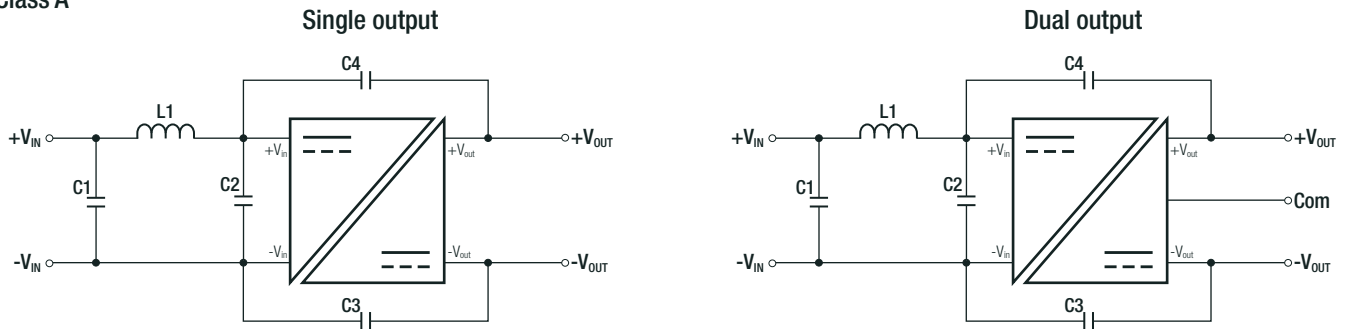

Component List Class A

MODEL	C1	C2	C3	C4	L1
REM3.5E-05xxS/R/A and REM3.5E-12xxS/R/A	4.7µF/50V	N/A	100pF/12kV	N/A	3.3µH
REM3.5E-24xxS/R/A and REM3.5E-48xxS/R/A			150pF/12kV		
REM3.5E-05xxD/R/A and REM3.5E-12xxD/R/A	10µF/100V		100pF/12kV	100pF/12kV	
REM3.5E-24xxD/R/A and REM3.5E-48xxD/R/A			150pF/12kV	150pF/12kV	

Class B

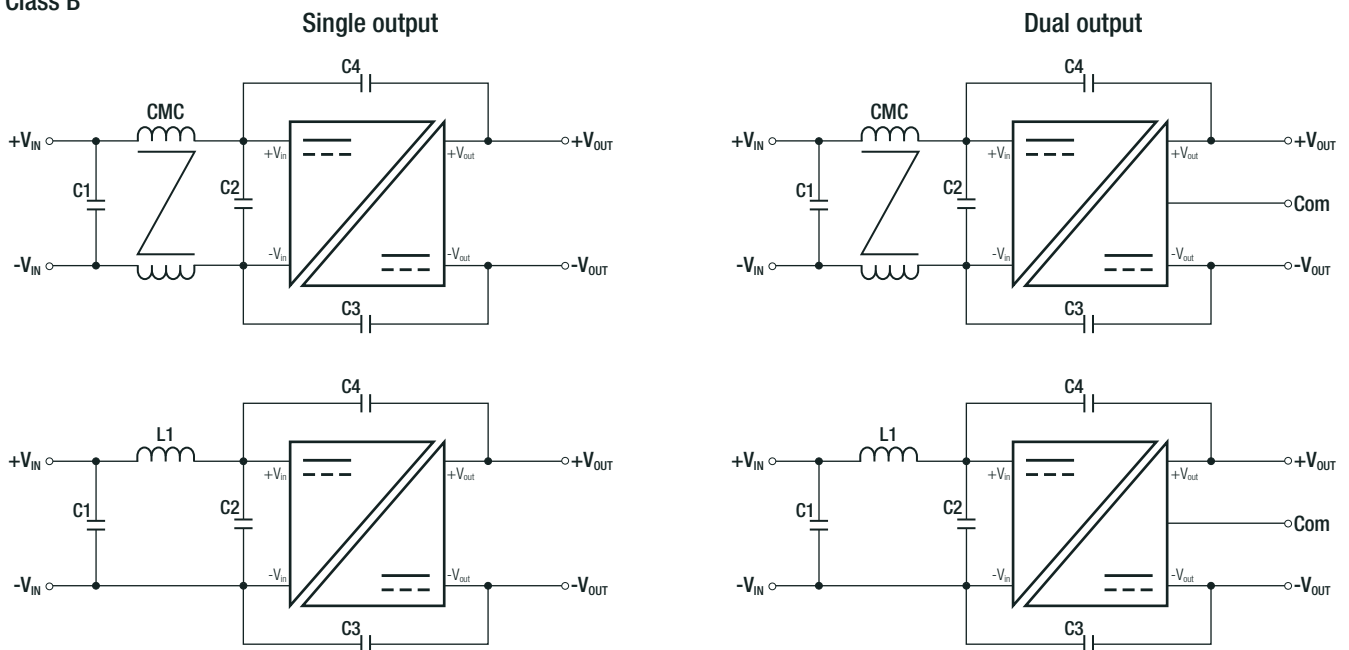

Component List Class B

MODEL	C1	C2	C3	C4	L1	CMC
REM3.5E-05xxS/R/A	4.7µF/50V	N/A	100pF/12kV	N/A	N/A	0.2mH
REM3.5E-12xxS/R/A		4.7µF/50V	220pF/12kV		50µH	N/A
REM3.5E-24xxS/R/A	10µF/100V	10µF/100V	220pF/12kV		N/A	1mH
REM3.5E-48xxS/R/A			330pF/12kV			
REM3.5E-05xxD/R/A	4.7µF/50V	N/A	100pF/12kV	100pF/12kV	N/A	0.2mH
REM3.5E-12xxD/R/A		4.7µF/50V	220pF/12kV	220pF/12kV	50µH	N/A
REM3.5E-24xxD/R/A	10µF/100V	10µF/100V	220pF/12kV	220pF/12kV		
REM3.5E-48xxD/R/A			330pF/12kV	330pF/12kV	N/A	1mH

Specifications (measured @ Ta= 25°C, nom. Vin, full load and after warm-up unless otherwise stated)

DIMENSION and PHYSICAL CHARACTERISTICS

Parameter	Type	Value
Material	baseplate	non-conductive black plastic, (UL94 V-0)
	case	non-conductive black plastic, (UL94 V-0)
	potting	silicone, (UL94 V-0)
Dimension (LxWxH)	DIP24	31.8 x 20.3 x 10.2mm
	SMD	31.8 x 20.3 x 10.9mm
Weight		14g typ.

Dimension Drawing (mm)

DIP24

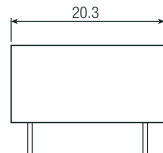
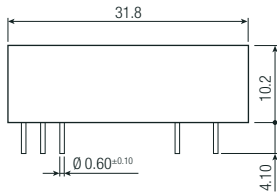
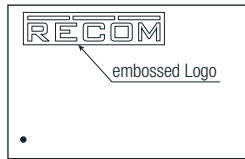

Recommended Footprint Details

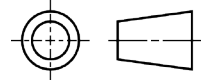
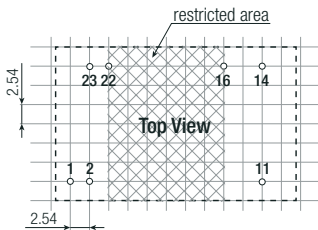
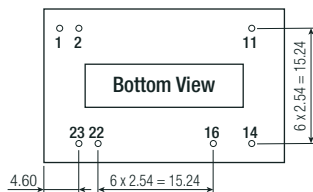

Pin Connections

Pin #	Single	Dual
1	CTRL ⁽⁴⁾	CTRL ⁽⁴⁾
2	-Vin	-Vin
11	NC	-Vout
14	+Vout	+Vout
16	-Vout	Com
22	+Vin	+Vin
23	+Vin	+Vin

Tolerance:
xx.x ± 0.5mm
xx.xx ± 0.25mm

SMD

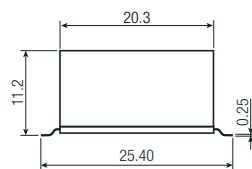
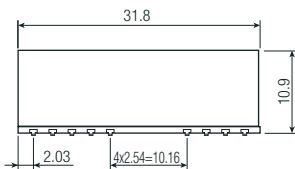
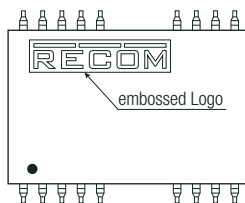

Recommended Footprint Details

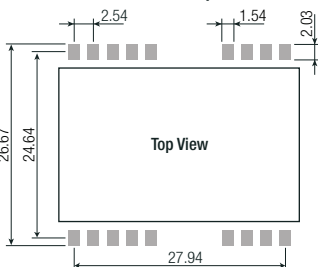
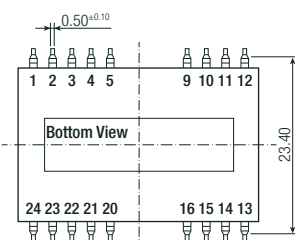

Pin Connections

Pin #	Single	Dual
1	CTRL	CTRL
2	-Vin	-Vin
3, 4, 5, 9, 10	NC	NC
11	NC	-Vout
12, 13, 15	NC	NC
14	+Vout	+Vout
16	-Vout	Com
20, 21, 24	NC	NC
22	+Vin	+Vin
23	+Vin	+Vin

Tolerance:
xx.x ± 0.5mm
xx.xx ± 0.35mm

Specifications (measured @ Ta= 25°C, nom. Vin, full load and after warm-up unless otherwise stated)

PACKAGING INFORMATION			
Parameter	Type		Value
Packaging Dimension (LxWxH)	tube	DIP24	520.0 x 22.7 x 18.3mm
		SMD	530.0 x 30.3 x 19.2mm
Packaging Quantity	tube		15pcs
Storage Temperature Range			-55°C to +125°C
Storage Humidity			95% RH max.

The product information and specifications may be subject to changes even without prior written notice. The product has been designed for various applications; its suitability lies in the responsibility of each customer. The products are not authorized for use in safety-critical applications without RECOM's explicit written consent. A safety-critical application is an application where a failure may reasonably be expected to endanger or cause loss of life, inflict bodily harm or damage property. The applicant shall indemnify and hold harmless RECOM, its affiliated companies and its representatives against any damage claims in connection with the unauthorized use of RECOM products in such safety-critical applications.



Компания «ЭлектроПласт» предлагает заключение долгосрочных отношений при поставках импортных электронных компонентов на взаимовыгодных условиях!

Наши преимущества:

- Оперативные поставки широкого спектра электронных компонентов отечественного и импортного производства напрямую от производителей и с крупнейших мировых складов;
- Поставка более 17-ти миллионов наименований электронных компонентов;
- Поставка сложных, дефицитных, либо снятых с производства позиций;
- Оперативные сроки поставки под заказ (от 5 рабочих дней);
- Экспресс доставка в любую точку России;
- Техническая поддержка проекта, помощь в подборе аналогов, поставка прототипов;
- Система менеджмента качества сертифицирована по Международному стандарту ISO 9001;
- Лицензия ФСБ на осуществление работ с использованием сведений, составляющих государственную тайну;
- Поставка специализированных компонентов (Xilinx, Altera, Analog Devices, Intersil, Interpoint, Microsemi, Aeroflex, Peregrine, Syfer, Eurofarad, Texas Instrument, Miteq, Cobham, E2V, MA-COM, Hittite, Mini-Circuits, General Dynamics и др.);

Помимо этого, одним из направлений компании «ЭлектроПласт» является направление «Источники питания». Мы предлагаем Вам помощь Конструкторского отдела:

- Подбор оптимального решения, техническое обоснование при выборе компонента;
- Подбор аналогов;
- Консультации по применению компонента;
- Поставка образцов и прототипов;
- Техническая поддержка проекта;
- Защита от снятия компонента с производства.



Как с нами связаться

Телефон: 8 (812) 309 58 32 (многоканальный)

Факс: 8 (812) 320-02-42

Электронная почта: org@eplast1.ru

Адрес: 198099, г. Санкт-Петербург, ул. Калинина, дом 2, корпус 4, литера А.