

EasyPIM™ Modul mit Trench/Feldstopp IGBT4 und Emitter Controlled 4 Diode und PressFIT / NTC / TIM  
 EasyPIM™ module with Trench/Fieldstop IGBT4 and Emitter Controlled 4 diode and PressFIT / NTC / TIM

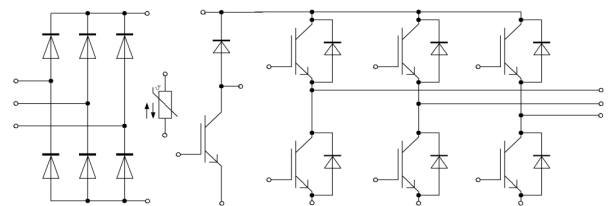
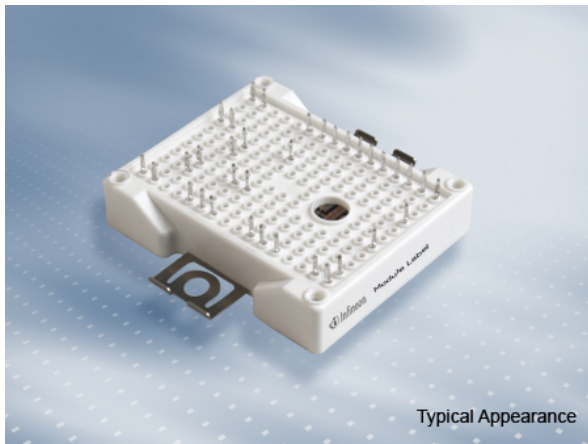

$V_{CES} = 1200V$   
 $I_{C\ nom} = 25A / I_{CRM} = 50A$

### Typische Anwendungen

- Hilfsumrichter
- Klimaanlage
- Motorantriebe

### Elektrische Eigenschaften

- Niedrige Schaltverluste
- Niedriges  $V_{CEsat}$
- Trench IGBT 4
- $V_{CEsat}$  mit positivem Temperaturkoeffizienten

### Mechanische Eigenschaften

- $Al_2O_3$  Substrat mit kleinem thermischen Widerstand
- Kompaktes Design
- PressFIT Verbindungstechnik
- Robuste Montage durch integrierte Befestigungsklammern
- Thermisches Interface Material bereits aufgetragen

### Typical Applications

- Auxiliary inverters
- Air conditioning
- Motor drives

### Electrical Features

- Low switching losses
- Low  $V_{CEsat}$
- Trench IGBT 4
- $V_{CEsat}$  with positive temperature coefficient

### Mechanical Features

- $Al_2O_3$  substrate with low thermal resistance
- Compact design
- PressFIT contact technology
- Rugged mounting due to integrated mounting clamps
- Pre-applied Thermal Interface Material

## Module Label Code

Barcode Code 128



DMX - Code



Content of the Code

| Content of the Code        | Digit   |
|----------------------------|---------|
| Module Serial Number       | 1 - 5   |
| Module Material Number     | 6 - 11  |
| Production Order Number    | 12 - 19 |
| Datecode (Production Year) | 20 - 21 |
| Datecode (Production Week) | 22 - 23 |

## IGBT, Wechselrichter / IGBT, Inverter Höchstzulässige Werte / Maximum Rated Values

|  |  |                   |       |   |
|--|--|-------------------|-------|---|
| Kollektor-Emitter-Sperrspannung<br>Collector-emitter voltage             | $T_{vj} = 25^{\circ}\text{C}$                                | $V_{CES}$         | 1200  | V |
| Kollektor-Dauergleichstrom<br>Continuous DC collector current            | $T_H = 90^{\circ}\text{C}, T_{vj\max} = 175^{\circ}\text{C}$ | $I_{C\text{nom}}$ | 25    | A |
| Periodischer Kollektor-Spitzenstrom<br>Repetitive peak collector current | $t_P = 1\text{ ms}$  | $I_{CRM}$         | 50    | A |
| Gate-Emitter-Spitzenspannung<br>Gate-emitter peak voltage                |  | $V_{GES}$         | +/-20 | V |

## Charakteristische Werte / Characteristic Values

|  |   |   | min.               | typ.                    | max. |             |   |
|--|---|---|--------------------|-------------------------|------|-------------|---|
| Kollektor-Emitter-Sättigungsspannung<br>Collector-emitter saturation voltage     | $I_C = 25\text{ A}, V_{GE} = 15\text{ V}$<br>$I_C = 25\text{ A}, V_{GE} = 15\text{ V}$<br>$I_C = 25\text{ A}, V_{GE} = 15\text{ V}$   | $T_{vj} = 25^{\circ}\text{C}$<br>$T_{vj} = 125^{\circ}\text{C}$<br>$T_{vj} = 150^{\circ}\text{C}$ | $V_{CE\text{sat}}$ | 1,85<br>2,15<br>2,25    | 2,25 | V<br>V<br>V |   |
| Gate-Schwellenspannung<br>Gate threshold voltage                                 | $I_C = 0,80\text{ mA}, V_{CE} = V_{GE}, T_{vj} = 25^{\circ}\text{C}$  |   | $V_{GEth}$         | 5,20                    | 5,80 | 6,40        | V   |
| Gateladung<br>Gate charge  | $V_{GE} = -15\text{ V} \dots +15\text{ V}$  |   | $Q_G$              | 0,20                    |      |             | $\mu\text{C}$                                   |
| Interner Gatewiderstand<br>Internal gate resistor                                | $T_{vj} = 25^{\circ}\text{C}$   |   | $R_{Gint}$         | 0,0                     |      |             | $\Omega$  |
| Eingangskapazität<br>Input capacitance   | $f = 1\text{ MHz}, T_{vj} = 25^{\circ}\text{C}, V_{CE} = 25\text{ V}, V_{GE} = 0\text{ V}$  |   | $C_{ies}$          | 1,45                    |      |             | nF  |
| Rückwirkungskapazität<br>Reverse transfer capacitance                            | $f = 1\text{ MHz}, T_{vj} = 25^{\circ}\text{C}, V_{CE} = 25\text{ V}, V_{GE} = 0\text{ V}$  |   | $C_{res}$          | 0,05                    |      |             | nF  |
| Kollektor-Emitter-Reststrom<br>Collector-emitter cut-off current                 | $V_{CE} = 1200\text{ V}, V_{GE} = 0\text{ V}, T_{vj} = 25^{\circ}\text{C}$  |   | $I_{CES}$          |                         |      | 1,0         | mA  |
| Gate-Emitter-Reststrom<br>Gate-emitter leakage current                           | $V_{CE} = 0\text{ V}, V_{GE} = 20\text{ V}, T_{vj} = 25^{\circ}\text{C}$  |   | $I_{GES}$          |                         |      | 100         | nA  |
| Einschaltverzögerungszeit, induktive Last<br>Turn-on delay time, inductive load  | $I_C = 25\text{ A}, V_{CE} = 600\text{ V}$<br>$V_{GE} = \pm 15\text{ V}$<br>$R_{Gon} = 20\ \Omega$  | $T_{vj} = 25^{\circ}\text{C}$<br>$T_{vj} = 125^{\circ}\text{C}$<br>$T_{vj} = 150^{\circ}\text{C}$ | $t_{don}$          | 0,026<br>0,026<br>0,026 |      |             | $\mu\text{s}$<br>$\mu\text{s}$<br>$\mu\text{s}$ |
| Anstiegszeit, induktive Last<br>Rise time, inductive load                        | $I_C = 25\text{ A}, V_{CE} = 600\text{ V}$<br>$V_{GE} = \pm 15\text{ V}$<br>$R_{Gon} = 20\ \Omega$  | $T_{vj} = 25^{\circ}\text{C}$<br>$T_{vj} = 125^{\circ}\text{C}$<br>$T_{vj} = 150^{\circ}\text{C}$ | $t_r$              | 0,016<br>0,02<br>0,021  |      |             | $\mu\text{s}$<br>$\mu\text{s}$<br>$\mu\text{s}$ |
| Abschaltverzögerungszeit, induktive Last<br>Turn-off delay time, inductive load  | $I_C = 25\text{ A}, V_{CE} = 600\text{ V}$<br>$V_{GE} = \pm 15\text{ V}$<br>$R_{Goff} = 20\ \Omega$   | $T_{vj} = 25^{\circ}\text{C}$<br>$T_{vj} = 125^{\circ}\text{C}$<br>$T_{vj} = 150^{\circ}\text{C}$ | $t_{doff}$         | 0,19<br>0,28<br>0,30    |      |             | $\mu\text{s}$<br>$\mu\text{s}$<br>$\mu\text{s}$ |
| Fallzeit, induktive Last<br>Fall time, inductive load                            | $I_C = 25\text{ A}, V_{CE} = 600\text{ V}$<br>$V_{GE} = \pm 15\text{ V}$<br>$R_{Goff} = 20\ \Omega$   | $T_{vj} = 25^{\circ}\text{C}$<br>$T_{vj} = 125^{\circ}\text{C}$<br>$T_{vj} = 150^{\circ}\text{C}$ | $t_f$              | 0,18<br>0,21<br>0,22    |      |             | $\mu\text{s}$<br>$\mu\text{s}$<br>$\mu\text{s}$ |
| Einschaltverlustenergie pro Puls<br>Turn-on energy loss per pulse                | $I_C = 25\text{ A}, V_{CE} = 600\text{ V}, L_S = 35\text{ nH}$<br>$V_{GE} = \pm 15\text{ V}, di/dt = 1700\text{ A}/\mu\text{s} (T_{vj} = 150^{\circ}\text{C})$<br>$R_{Gon} = 20\ \Omega$  | $T_{vj} = 25^{\circ}\text{C}$<br>$T_{vj} = 125^{\circ}\text{C}$<br>$T_{vj} = 150^{\circ}\text{C}$ | $E_{on}$           | 1,60<br>2,40<br>2,60    |      |             | mJ<br>mJ<br>mJ                                  |
| Abschaltverlustenergie pro Puls<br>Turn-off energy loss per pulse                | $I_C = 25\text{ A}, V_{CE} = 600\text{ V}, L_S = 35\text{ nH}$<br>$V_{GE} = \pm 15\text{ V}, du/dt = 3600\text{ V}/\mu\text{s} (T_{vj} = 150^{\circ}\text{C})$<br>$R_{Goff} = 20\ \Omega$ | $T_{vj} = 25^{\circ}\text{C}$<br>$T_{vj} = 125^{\circ}\text{C}$<br>$T_{vj} = 150^{\circ}\text{C}$ | $E_{off}$          | 1,45<br>2,15<br>2,35    |      |             | mJ<br>mJ<br>mJ                                  |
| Kurzschlußverhalten<br>SC data   | $V_{GE} \leq 15\text{ V}, V_{CC} = 800\text{ V}$<br>$V_{CEmax} = V_{CES} - L_{SCE} \cdot di/dt$ $t_P \leq 10\ \mu\text{s}, T_{vj} = 150^{\circ}\text{C}$                                  |   | $I_{SC}$           | 90                      |      |             | A   |
| Wärmewiderstand, Chip bis Kühlkörper<br>Thermal resistance, junction to heatsink | pro IGBT / per IGBT<br>valid with IFX pre-applied thermal interface material  |   | $R_{thJH}$         |                         |      | 1,19        | K/W   |
| Temperatur im Schaltbetrieb<br>Temperature under switching conditions            |   |   | $T_{vj\text{op}}$  | -40                     |      | 150         | $^{\circ}\text{C}$                              |

## Diode, Wechselrichter / Diode, Inverter

### Höchstzulässige Werte / Maximum Rated Values

|   |  |           |              |  |
|---|--|-----------|--------------|--|
| Periodische Spitzensperrspannung<br>Repetitive peak reverse voltage | $T_{vj} = 25^{\circ}\text{C}$  | $V_{RRM}$ | 1200         | V  |
| Dauergleichstrom<br>Continuous DC forward current                   |  | $I_F$     | 25           | A  |
| Periodischer Spitzenstrom<br>Repetitive peak forward current        | $t_p = 1 \text{ ms}$   | $I_{FRM}$ | 50           | A  |
| Grenzlastintegral<br>$I^2t$ - value                                 | $V_R = 0 \text{ V}, t_p = 10 \text{ ms}, T_{vj} = 125^{\circ}\text{C}$<br>$V_R = 0 \text{ V}, t_p = 10 \text{ ms}, T_{vj} = 150^{\circ}\text{C}$ | $I^2t$    | 90,0<br>75,0 | $\text{A}^2\text{s}$<br>$\text{A}^2\text{s}$ |

### Charakteristische Werte / Characteristic Values

|  |   |   | min.        | typ.                 | max. |   |
|--|---|---|-------------|----------------------|------|---|
| Durchlassspannung<br>Forward voltage   | $I_F = 25 \text{ A}, V_{GE} = 0 \text{ V}$<br>$I_F = 25 \text{ A}, V_{GE} = 0 \text{ V}$<br>$I_F = 25 \text{ A}, V_{GE} = 0 \text{ V}$        | $T_{vj} = 25^{\circ}\text{C}$<br>$T_{vj} = 125^{\circ}\text{C}$<br>$T_{vj} = 150^{\circ}\text{C}$ | $V_F$       | 1,75<br>1,75<br>1,75 | 2,25 | V<br>V<br>V                                     |
| Rückstromspitze<br>Peak reverse recovery current                                 | $I_F = 25 \text{ A}, -di_F/dt = 1700 \text{ A}/\mu\text{s} (T_{vj}=150^{\circ}\text{C})$<br>$V_R = 600 \text{ V}$<br>$V_{GE} = -15 \text{ V}$ | $T_{vj} = 25^{\circ}\text{C}$<br>$T_{vj} = 125^{\circ}\text{C}$<br>$T_{vj} = 150^{\circ}\text{C}$ | $I_{RM}$    | 48,0<br>50,0<br>52,0 |      | A<br>A<br>A                                     |
| Sperrverzögerungsladung<br>Recovered charge                                      | $I_F = 25 \text{ A}, -di_F/dt = 1700 \text{ A}/\mu\text{s} (T_{vj}=150^{\circ}\text{C})$<br>$V_R = 600 \text{ V}$<br>$V_{GE} = -15 \text{ V}$ | $T_{vj} = 25^{\circ}\text{C}$<br>$T_{vj} = 125^{\circ}\text{C}$<br>$T_{vj} = 150^{\circ}\text{C}$ | $Q_r$       | 2,50<br>4,40<br>4,90 |      | $\mu\text{C}$<br>$\mu\text{C}$<br>$\mu\text{C}$ |
| Abschaltenergie pro Puls<br>Reverse recovery energy                              | $I_F = 25 \text{ A}, -di_F/dt = 1700 \text{ A}/\mu\text{s} (T_{vj}=150^{\circ}\text{C})$<br>$V_R = 600 \text{ V}$<br>$V_{GE} = -15 \text{ V}$ | $T_{vj} = 25^{\circ}\text{C}$<br>$T_{vj} = 125^{\circ}\text{C}$<br>$T_{vj} = 150^{\circ}\text{C}$ | $E_{rec}$   | 0,95<br>1,75<br>2,05 |      | mJ<br>mJ<br>mJ                                  |
| Wärmewiderstand, Chip bis Kühlkörper<br>Thermal resistance, junction to heatsink | pro Diode / per diode<br>valid with IFX pre-applied thermal interface material  |   | $R_{thJH}$  |                      | 1,58 | K/W   |
| Temperatur im Schaltbetrieb<br>Temperature under switching conditions            |   |   | $T_{vj op}$ | -40                  | 150  | $^{\circ}\text{C}$                              |

## Diode, Gleichrichter / Diode, Rectifier

### Höchstzulässige Werte / Maximum Rated Values

|   |   |             |             |  |
|---|---|-------------|-------------|--|
| Periodische Spitzensperrspannung<br>Repetitive peak reverse voltage                 | $T_{vj} = 25^{\circ}\text{C}$   | $V_{RRM}$   | 1600        | V  |
| Durchlassstrom Grenzeffektivwert pro Chip<br>Maximum RMS forward current per chip   | $T_H = 80^{\circ}\text{C}$  | $I_{FRMSM}$ | 50          | A  |
| Gleichrichter Ausgang Grenzeffektivstrom<br>Maximum RMS current at rectifier output | $T_H = 80^{\circ}\text{C}$  | $I_{RMSM}$  | 50          | A  |
| Stoßstrom Grenzwert<br>Surge forward current  | $t_p = 10 \text{ ms}, T_{vj} = 25^{\circ}\text{C}$<br>$t_p = 10 \text{ ms}, T_{vj} = 150^{\circ}\text{C}$ | $I_{FSM}$   | 450<br>370  | A<br>A                                       |
| Grenzlastintegral<br>$I^2t$ - value   | $t_p = 10 \text{ ms}, T_{vj} = 25^{\circ}\text{C}$<br>$t_p = 10 \text{ ms}, T_{vj} = 150^{\circ}\text{C}$ | $I^2t$      | 1000<br>685 | $\text{A}^2\text{s}$<br>$\text{A}^2\text{s}$ |

### Charakteristische Werte / Characteristic Values

|  |  |       | min.        | typ. | max. |                    |
|--|--|-------|-------------|------|------|--------------------|
| Durchlassspannung<br>Forward voltage   | $T_{vj} = 150^{\circ}\text{C}, I_F = 25 \text{ A}$                             | $V_F$ |             | 0,90 |      | V                  |
| Sperrstrom<br>Reverse current  | $T_{vj} = 150^{\circ}\text{C}, V_R = 1600 \text{ V}$                           | $I_R$ |             | 1,00 |      | mA                 |
| Wärmewiderstand, Chip bis Kühlkörper<br>Thermal resistance, junction to heatsink | pro Diode / per diode<br>valid with IFX pre-applied thermal interface material |       | $R_{thJH}$  |      | 1,42 | K/W                |
| Temperatur im Schaltbetrieb<br>Temperature under switching conditions            |  |       | $T_{vj op}$ | -40  | 150  | $^{\circ}\text{C}$ |

## IGBT, Brems-Chopper / IGBT, Brake-Chopper Höchstzulässige Werte / Maximum Rated Values

|  |   |                    |       |   |
|--|---|--------------------|-------|---|
| Kollektor-Emitter-Sperrspannung<br>Collector-emitter voltage             | $T_{vj} = 25^{\circ}\text{C}$                                       | $V_{CES}$          | 1200  | V |
| Kollektor-Dauergleichstrom<br>Continuous DC collector current            | $T_H = 90^{\circ}\text{C}, T_{vj\text{ max}} = 175^{\circ}\text{C}$ | $I_{C\text{ nom}}$ | 25    | A |
| Periodischer Kollektor-Spitzenstrom<br>Repetitive peak collector current | $t_P = 1\text{ ms}$   | $I_{CRM}$          | 50    | A |
| Gate-Emitter-Spitzenspannung<br>Gate-emitter peak voltage                |   | $V_{GES}$          | +/-20 | V |

## Charakteristische Werte / Characteristic Values

|  |   |   | min.                | typ.                    | max. |             |   |
|--|---|---|---------------------|-------------------------|------|-------------|---|
| Kollektor-Emitter-Sättigungsspannung<br>Collector-emitter saturation voltage     | $I_C = 25\text{ A}, V_{GE} = 15\text{ V}$<br>$I_C = 25\text{ A}, V_{GE} = 15\text{ V}$<br>$I_C = 25\text{ A}, V_{GE} = 15\text{ V}$   | $T_{vj} = 25^{\circ}\text{C}$<br>$T_{vj} = 125^{\circ}\text{C}$<br>$T_{vj} = 150^{\circ}\text{C}$ | $V_{CE\text{ sat}}$ | 1,85<br>2,15<br>2,25    | 2,25 | V<br>V<br>V |   |
| Gate-Schwellenspannung<br>Gate threshold voltage                                 | $I_C = 0,80\text{ mA}, V_{CE} = V_{GE}, T_{vj} = 25^{\circ}\text{C}$  |   | $V_{GEth}$          | 5,20                    | 5,80 | 6,40        | V   |
| Gateladung<br>Gate charge  | $V_{GE} = -15\text{ V} \dots +15\text{ V}$  |   | $Q_G$               | 0,20                    |      |             | $\mu\text{C}$                                   |
| Interner Gatewiderstand<br>Internal gate resistor                                | $T_{vj} = 25^{\circ}\text{C}$   |   | $R_{Gint}$          | 0,0                     |      |             | $\Omega$  |
| Eingangskapazität<br>Input capacitance   | $f = 1\text{ MHz}, T_{vj} = 25^{\circ}\text{C}, V_{CE} = 25\text{ V}, V_{GE} = 0\text{ V}$  |   | $C_{ies}$           | 1,45                    |      |             | nF  |
| Rückwirkungskapazität<br>Reverse transfer capacitance                            | $f = 1\text{ MHz}, T_{vj} = 25^{\circ}\text{C}, V_{CE} = 25\text{ V}, V_{GE} = 0\text{ V}$  |   | $C_{res}$           | 0,05                    |      |             | nF  |
| Kollektor-Emitter-Reststrom<br>Collector-emitter cut-off current                 | $V_{CE} = 1200\text{ V}, V_{GE} = 0\text{ V}, T_{vj} = 25^{\circ}\text{C}$  |   | $I_{CES}$           |                         |      | 1,0         | mA  |
| Gate-Emitter-Reststrom<br>Gate-emitter leakage current                           | $V_{CE} = 0\text{ V}, V_{GE} = 20\text{ V}, T_{vj} = 25^{\circ}\text{C}$  |   | $I_{GES}$           |                         |      | 100         | nA  |
| Einschaltverzögerungszeit, induktive Last<br>Turn-on delay time, inductive load  | $I_C = 25\text{ A}, V_{CE} = 600\text{ V}$<br>$V_{GE} = \pm 15\text{ V}$<br>$R_{Gon} = 68\ \Omega$  | $T_{vj} = 25^{\circ}\text{C}$<br>$T_{vj} = 125^{\circ}\text{C}$<br>$T_{vj} = 150^{\circ}\text{C}$ | $t_{don}$           | 0,08<br>0,08<br>0,08    |      |             | $\mu\text{s}$<br>$\mu\text{s}$<br>$\mu\text{s}$ |
| Anstiegszeit, induktive Last<br>Rise time, inductive load                        | $I_C = 25\text{ A}, V_{CE} = 600\text{ V}$<br>$V_{GE} = \pm 15\text{ V}$<br>$R_{Gon} = 68\ \Omega$  | $T_{vj} = 25^{\circ}\text{C}$<br>$T_{vj} = 125^{\circ}\text{C}$<br>$T_{vj} = 150^{\circ}\text{C}$ | $t_r$               | 0,042<br>0,051<br>0,053 |      |             | $\mu\text{s}$<br>$\mu\text{s}$<br>$\mu\text{s}$ |
| Abschaltverzögerungszeit, induktive Last<br>Turn-off delay time, inductive load  | $I_C = 25\text{ A}, V_{CE} = 600\text{ V}$<br>$V_{GE} = \pm 15\text{ V}$<br>$R_{Goff} = 68\ \Omega$   | $T_{vj} = 25^{\circ}\text{C}$<br>$T_{vj} = 125^{\circ}\text{C}$<br>$T_{vj} = 150^{\circ}\text{C}$ | $t_{doff}$          | 0,34<br>0,44<br>0,46    |      |             | $\mu\text{s}$<br>$\mu\text{s}$<br>$\mu\text{s}$ |
| Fallzeit, induktive Last<br>Fall time, inductive load                            | $I_C = 25\text{ A}, V_{CE} = 600\text{ V}$<br>$V_{GE} = \pm 15\text{ V}$<br>$R_{Goff} = 68\ \Omega$   | $T_{vj} = 25^{\circ}\text{C}$<br>$T_{vj} = 125^{\circ}\text{C}$<br>$T_{vj} = 150^{\circ}\text{C}$ | $t_f$               | 0,18<br>0,215<br>0,225  |      |             | $\mu\text{s}$<br>$\mu\text{s}$<br>$\mu\text{s}$ |
| Einschaltverlustenergie pro Puls<br>Turn-on energy loss per pulse                | $I_C = 25\text{ A}, V_{CE} = 600\text{ V}, L_S = 35\text{ nH}$<br>$V_{GE} = \pm 15\text{ V}, di/dt = 500\text{ A}/\mu\text{s} (T_{vj} = 150^{\circ}\text{C})$<br>$R_{Gon} = 68\ \Omega$   | $T_{vj} = 25^{\circ}\text{C}$<br>$T_{vj} = 125^{\circ}\text{C}$<br>$T_{vj} = 150^{\circ}\text{C}$ | $E_{on}$            | 3,90<br>5,00<br>5,40    |      |             | mJ<br>mJ<br>mJ                                  |
| Abschaltverlustenergie pro Puls<br>Turn-off energy loss per pulse                | $I_C = 25\text{ A}, V_{CE} = 600\text{ V}, L_S = 35\text{ nH}$<br>$V_{GE} = \pm 15\text{ V}, du/dt = 3200\text{ V}/\mu\text{s} (T_{vj} = 150^{\circ}\text{C})$<br>$R_{Goff} = 68\ \Omega$ | $T_{vj} = 25^{\circ}\text{C}$<br>$T_{vj} = 125^{\circ}\text{C}$<br>$T_{vj} = 150^{\circ}\text{C}$ | $E_{off}$           | 1,50<br>2,20<br>2,40    |      |             | mJ<br>mJ<br>mJ                                  |
| Kurzschlußverhalten<br>SC data   | $V_{GE} \leq 15\text{ V}, V_{CC} = 800\text{ V}$<br>$V_{CEmax} = V_{CES} - L_{SCE} \cdot di/dt$ $t_P \leq 10\ \mu\text{s}, T_{vj} = 150^{\circ}\text{C}$                                  |   | $I_{SC}$            | 90                      |      |             | A   |
| Wärmewiderstand, Chip bis Kühlkörper<br>Thermal resistance, junction to heatsink | pro IGBT / per IGBT<br>valid with IFX pre-applied thermal interface material  |   | $R_{thJH}$          |                         |      | 1,19        | K/W   |
| Temperatur im Schaltbetrieb<br>Temperature under switching conditions            |   |   | $T_{vj\text{ op}}$  | -40                     |      | 150         | $^{\circ}\text{C}$                              |

## Diode, Brems-Chopper / Diode, Brake-Chopper Höchstzulässige Werte / Maximum Rated Values

|  |  |           |              |  |
|--|--|-----------|--------------|--|
| Periodische Spitzenspernung<br>Repetitive peak reverse voltage | $T_{vj} = 25^{\circ}\text{C}$  | $V_{RRM}$ | 1200         | V  |
| Dauergleichstrom<br>Continuous DC forward current              |  | $I_F$     | 10           | A  |
| Periodischer Spitzenstrom<br>Repetitive peak forward current   | $t_p = 1\text{ ms}$  | $I_{FRM}$ | 20           | A  |
| Grenzlastintegral<br>$I^2t$ - value                            | $V_R = 0\text{ V}, t_p = 10\text{ ms}, T_{vj} = 125^{\circ}\text{C}$<br>$V_R = 0\text{ V}, t_p = 10\text{ ms}, T_{vj} = 150^{\circ}\text{C}$ | $I^2t$    | 16,0<br>14,0 | $\text{A}^2\text{s}$<br>$\text{A}^2\text{s}$ |

## Charakteristische Werte / Characteristic Values

|  |   |                                | min.      | typ. | max. |                    |
|--|---|--------------------------------|-----------|------|------|--------------------|
| Durchlassspannung<br>Forward voltage   | $I_F = 10\text{ A}, V_{GE} = 0\text{ V}$  | $T_{vj} = 25^{\circ}\text{C}$  |           | 1,75 | 2,25 | V                  |
|  | $I_F = 10\text{ A}, V_{GE} = 0\text{ V}$  | $T_{vj} = 125^{\circ}\text{C}$ | $V_F$     | 1,75 |      | V                  |
|  | $I_F = 10\text{ A}, V_{GE} = 0\text{ V}$  | $T_{vj} = 150^{\circ}\text{C}$ |           | 1,75 |      | V                  |
| Rückstromspitze<br>Peak reverse recovery current                                 | $I_F = 10\text{ A}, -di_F/dt = 500\text{ A}/\mu\text{s} (T_{vj}=150^{\circ}\text{C})$<br>$V_R = 600\text{ V}$ | $T_{vj} = 25^{\circ}\text{C}$  |           | 12,0 |      | A                  |
|  |   | $T_{vj} = 125^{\circ}\text{C}$ | $I_{RM}$  | 10,0 |      | A                  |
|  |   | $T_{vj} = 150^{\circ}\text{C}$ |           | 8,00 |      | A                  |
| Sperrverzögerungsladung<br>Recovered charge                                      | $I_F = 10\text{ A}, -di_F/dt = 500\text{ A}/\mu\text{s} (T_{vj}=150^{\circ}\text{C})$<br>$V_R = 600\text{ V}$ | $T_{vj} = 25^{\circ}\text{C}$  |           | 0,90 |      | $\mu\text{C}$      |
|  |   | $T_{vj} = 125^{\circ}\text{C}$ | $Q_r$     | 1,70 |      | $\mu\text{C}$      |
|  |   | $T_{vj} = 150^{\circ}\text{C}$ |           | 1,90 |      | $\mu\text{C}$      |
| Abschaltenergie pro Puls<br>Reverse recovery energy                              | $I_F = 10\text{ A}, -di_F/dt = 500\text{ A}/\mu\text{s} (T_{vj}=150^{\circ}\text{C})$<br>$V_R = 600\text{ V}$ | $T_{vj} = 25^{\circ}\text{C}$  |           | 0,24 |      | mJ                 |
|  |   | $T_{vj} = 125^{\circ}\text{C}$ | $E_{rec}$ | 0,52 |      | mJ                 |
|  |   | $T_{vj} = 150^{\circ}\text{C}$ |           | 0,59 |      | mJ                 |
| Wärmewiderstand, Chip bis Kühlkörper<br>Thermal resistance, junction to heatsink | pro Diode / per diode<br>valid with IFX pre-applied thermal interface material                                | $R_{thJH}$                     |           |      | 2,69 | K/W                |
| Temperatur im Schaltbetrieb<br>Temperature under switching conditions            |   | $T_{vj\text{ op}}$             | -40       |      | 150  | $^{\circ}\text{C}$ |

## NTC-Widerstand / NTC-Thermistor

### Charakteristische Werte / Characteristic Values

|  |   |              | min. | typ. | max. |            |
|--|---|--------------|------|------|------|------------|
| Nennwiderstand<br>Rated resistance       | $T_{NTC} = 25^{\circ}\text{C}$                                | $R_{25}$     |      | 5,00 |      | k $\Omega$ |
| Abweichung von R100<br>Deviation of R100 | $T_{NTC} = 100^{\circ}\text{C}, R_{100} = 493\ \Omega$        | $\Delta R/R$ | -5   |      | 5    | %          |
| Verlustleistung<br>Power dissipation     | $T_{NTC} = 25^{\circ}\text{C}$                                | $P_{25}$     |      |      | 20,0 | mW         |
| B-Wert<br>B-value                        | $R_2 = R_{25} \exp [B_{25/50}(1/T_2 - 1/(298,15\text{ K}))]$  | $B_{25/50}$  |      | 3375 |      | K          |
| B-Wert<br>B-value                        | $R_2 = R_{25} \exp [B_{25/80}(1/T_2 - 1/(298,15\text{ K}))]$  | $B_{25/80}$  |      | 3411 |      | K          |
| B-Wert<br>B-value                        | $R_2 = R_{25} \exp [B_{25/100}(1/T_2 - 1/(298,15\text{ K}))]$ | $B_{25/100}$ |      | 3433 |      | K          |

Angaben gemäß gültiger Application Note.  
Specification according to the valid application note.

## Modul / Module

|  |   |  |                                |              |      |    |
|--|---|--|--------------------------------|--------------|------|----|
| Isolations-Prüfspannung<br>Isolation test voltage  | RMS, f = 50 Hz, t = 1 min.  | V <sub>ISOL</sub>                            | 2,5                            |              |      | kV |
| Innere Isolation<br>Internal isolation   | Basisisolierung (Schutzklasse 1, EN61140)<br>basic insulation (class 1, IEC 61140)      |  | Al <sub>2</sub> O <sub>3</sub> |              |      |    |
| Kriechstrecke<br>Creepage distance   | Kontakt - Kühlkörper / terminal to heatsink<br>Kontakt - Kontakt / terminal to terminal |  | 11,5<br>6,3                    |              |      | mm |
| Luftstrecke<br>Clearance   | Kontakt - Kühlkörper / terminal to heatsink<br>Kontakt - Kontakt / terminal to terminal |  | 10,0<br>5,0                    |              |      | mm |
| Vergleichszahl der Kriechwegbildung<br>Comperative tracking index                            |   | CTI  | > 200                          |              |      |    |
|  |   |  | min.                           | typ.         | max. |    |
| Modulstreuintduktivität<br>Stray inductance module   |   | L <sub>sCE</sub>                             |                                | 30           |      | nH |
| Modulleitungswiderstand, Anschlüsse -<br>Chip<br>Module lead resistance, terminals - chip    | T <sub>H</sub> = 25°C, pro Schalter / per switch  | R <sub>CC'+EE'</sub><br>R <sub>AA'+CC'</sub> |                                | 5,00<br>6,00 |      | mΩ |
| Lagertemperatur<br>Storage temperature   |   | T <sub>stg</sub>                             | -40                            |              | 125  | °C |
| Höchstzulässige<br>Bodenplattenbetriebstemperatur<br>Maximum baseplate operation temperature |   | T <sub>BPmax</sub>                           |                                |              | 125  | °C |
| Anpresskraft für mech. Bef. pro Feder<br>mounting force per clamp                            |   | F  | 40                             | -            | 80   | N  |
| Gewicht<br>Weight  |   | G  |                                | 39           |      | g  |

Der Strom im Dauerbetrieb ist auf 25A effektiv pro Anschlusspin begrenzt.  
The current under continuous operation is limited to 25A rms per connector pin.  
Lagerung und Transport von Modulen mit TIM => siehe AN2012-07  
Storage and shipment of modules with TIM => see AN2012-07

**Ausgangskennlinie IGBT, Wechselrichter (typisch)**  
**output characteristic IGBT, Inverter (typical)**

$I_C = f(V_{CE})$   
 $V_{GE} = 15\text{ V}$

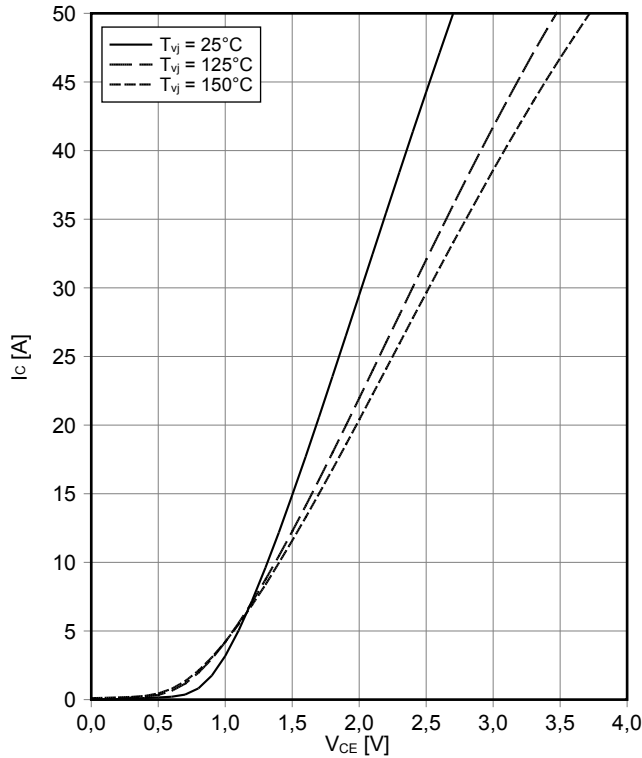

**Ausgangskennlinienfeld IGBT, Wechselrichter (typisch)**  
**output characteristic IGBT, Inverter (typical)**

$I_C = f(V_{CE})$   
 $T_{vj} = 150^\circ\text{C}$

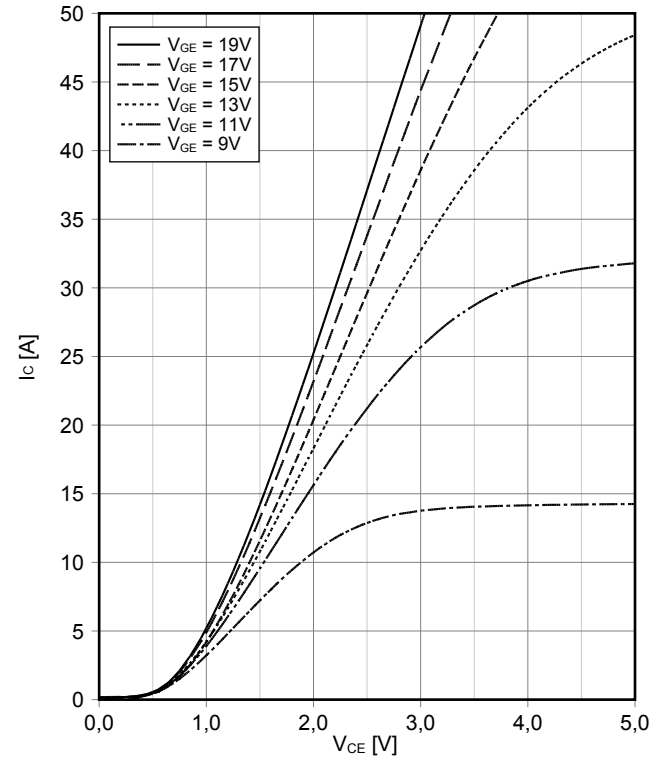

**Übertragungscharakteristik IGBT, Wechselrichter (typisch)**  
**transfer characteristic IGBT, Inverter (typical)**

$I_C = f(V_{GE})$   
 $V_{CE} = 20\text{ V}$

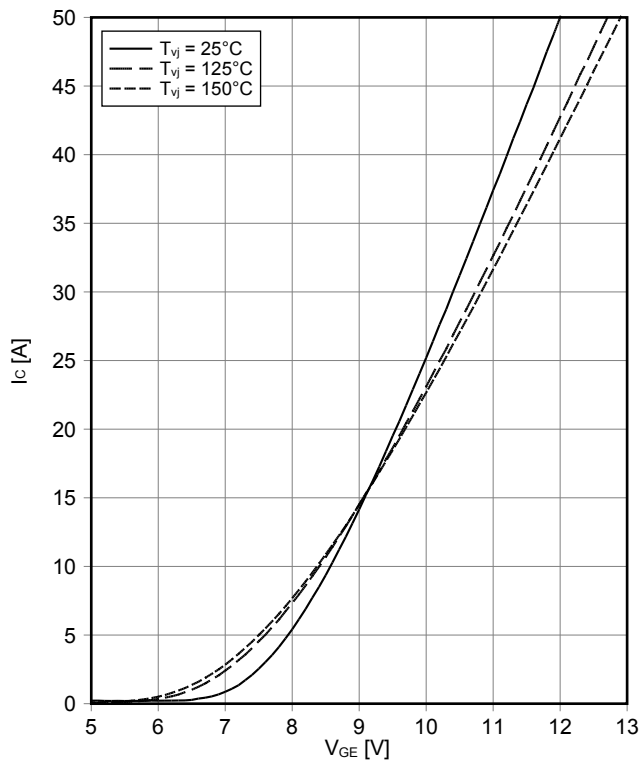

**Schaltverluste IGBT, Wechselrichter (typisch)**  
**switching losses IGBT, Inverter (typical)**

$E_{on} = f(I_C)$ ,  $E_{off} = f(I_C)$   
 $V_{GE} = \pm 15\text{ V}$ ,  $R_{Gon} = 20\ \Omega$ ,  $R_{Goff} = 20\ \Omega$ ,  $V_{CE} = 600\text{ V}$

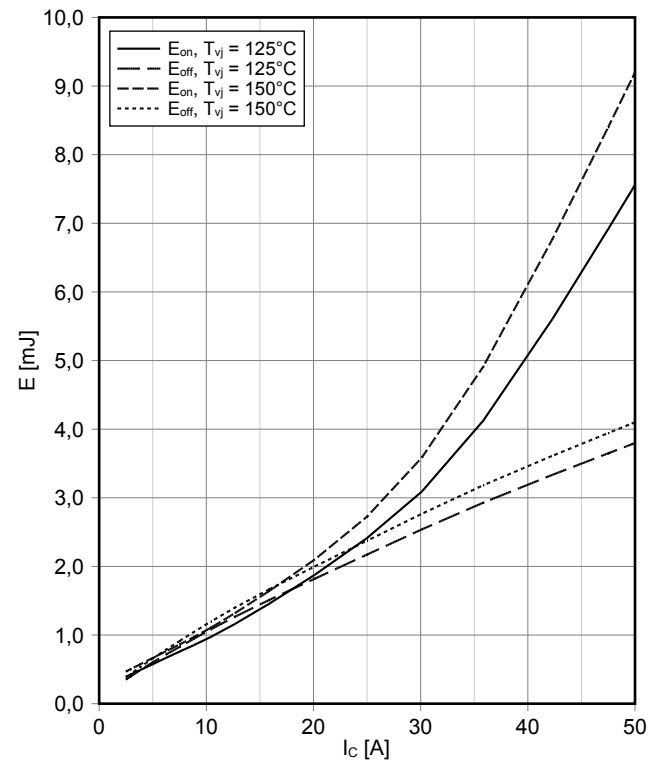

### Schaltverluste IGBT, Wechselrichter (typisch) switching losses IGBT, Inverter (typical)

$E_{on} = f(R_G)$ ,  $E_{off} = f(R_G)$   
 $V_{GE} = \pm 15\text{ V}$ ,  $I_C = 25\text{ A}$ ,  $V_{CE} = 600\text{ V}$

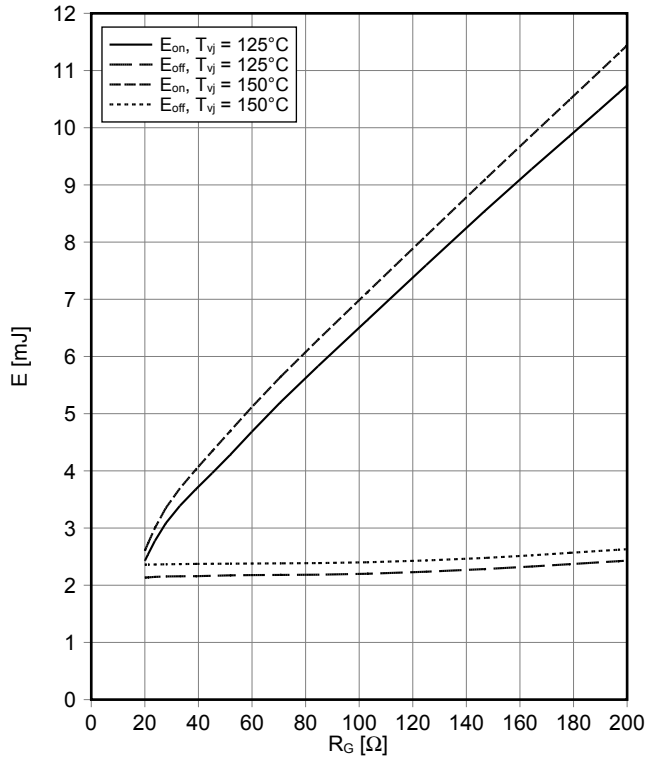

### Transienter Wärmewiderstand IGBT, Wechselrichter transient thermal impedance IGBT, Inverter

$Z_{thJH} = f(t)$

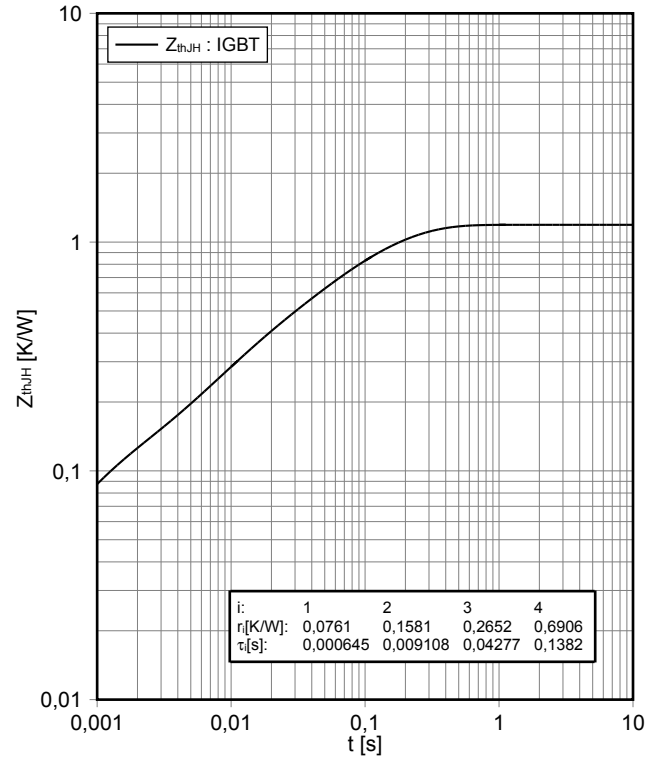

### Sicherer Rückwärts-Arbeitsbereich IGBT, Wechselrichter (RBSOA) reverse bias safe operating area IGBT, Inverter (RBSOA)

$I_C = f(V_{CE})$   
 $V_{GE} = \pm 15\text{ V}$ ,  $R_{Goff} = 20\ \Omega$ ,  $T_{vj} = 150^\circ\text{C}$

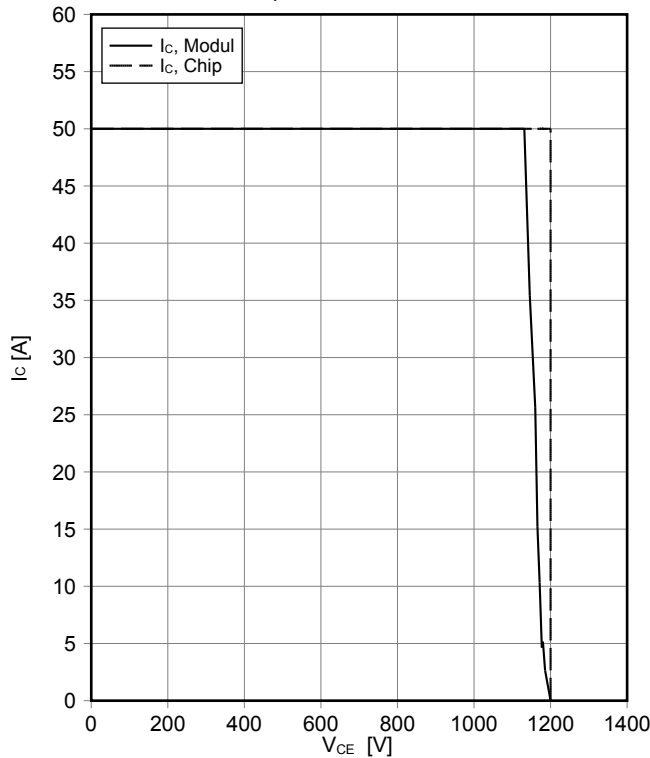

### Durchlasskennlinie der Diode, Wechselrichter (typisch) forward characteristic of Diode, Inverter (typical)

$I_F = f(V_F)$

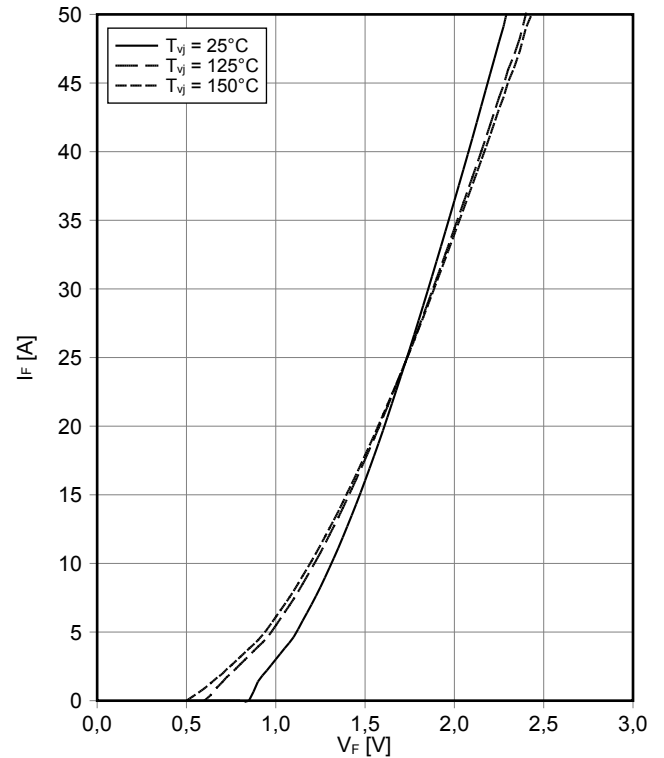



**Schaltverluste Diode, Wechselrichter (typisch)**  
**switching losses Diode, Inverter (typical)**

$E_{rec} = f(I_F)$   
 $R_{Gon} = 20 \Omega, V_{CE} = 600 V$

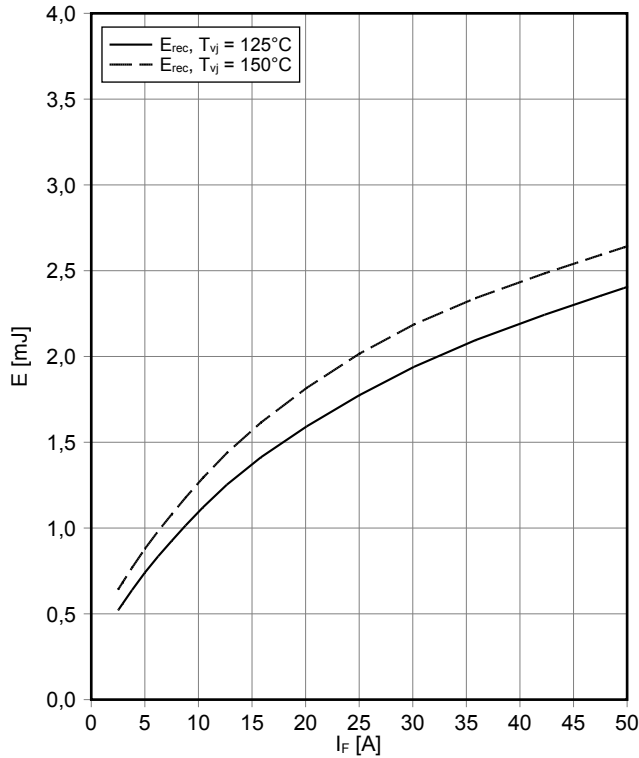

**Schaltverluste Diode, Wechselrichter (typisch)**  
**switching losses Diode, Inverter (typical)**

$E_{rec} = f(R_G)$   
 $I_F = 25 A, V_{CE} = 600 V$

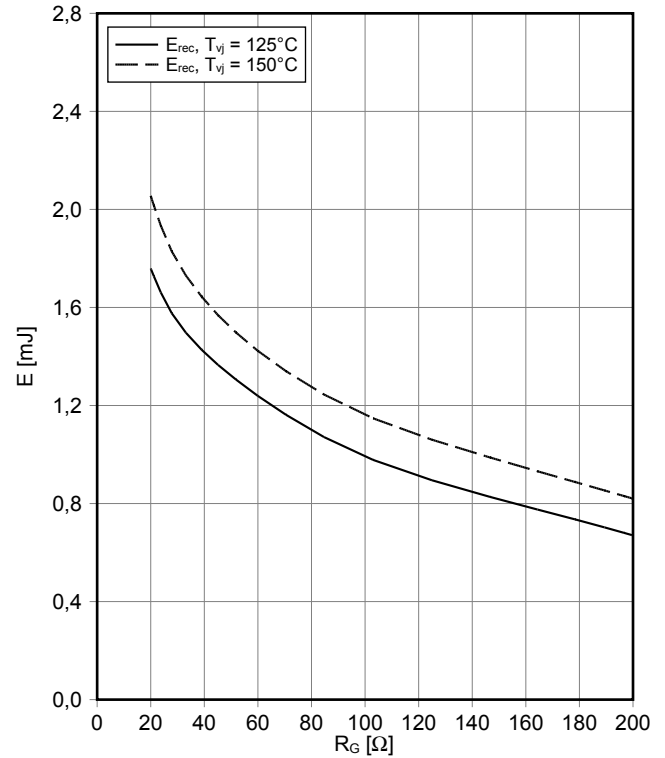

**Transienter Wärmewiderstand Diode, Wechselrichter**  
**transient thermal impedance Diode, Inverter**

$Z_{thJH} = f(t)$

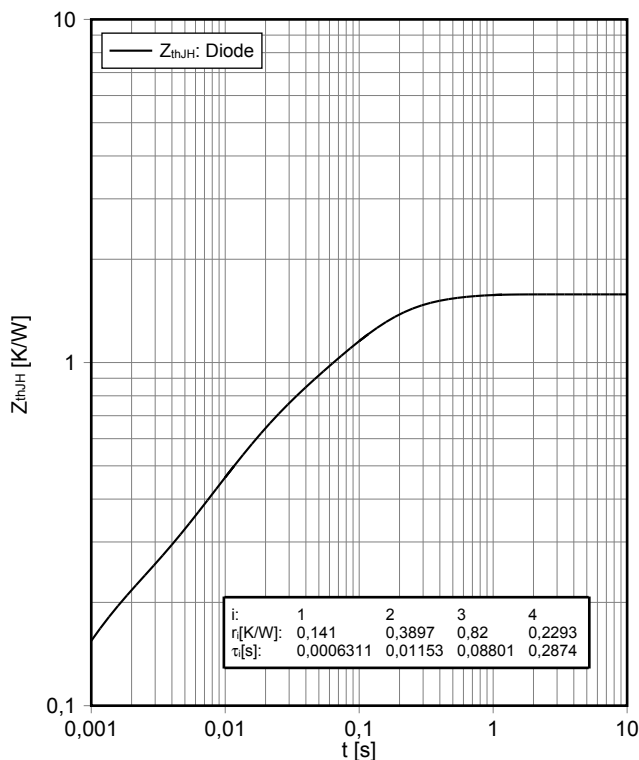

**Durchlasskennlinie der Diode, Gleichrichter (typisch)**  
**forward characteristic of Diode, Rectifier (typical)**

$I_F = f(V_F)$

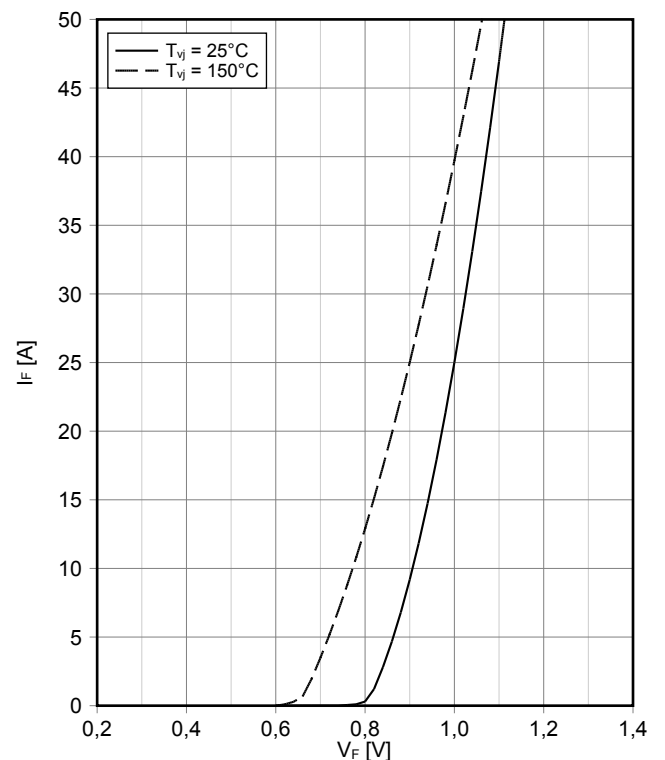

**Ausgangskennlinie IGBT, Brems-Chopper (typisch)**  
**output characteristic IGBT, Brake-Chopper (typical)**

$I_C = f(V_{CE})$   
 $V_{GE} = 15\text{ V}$

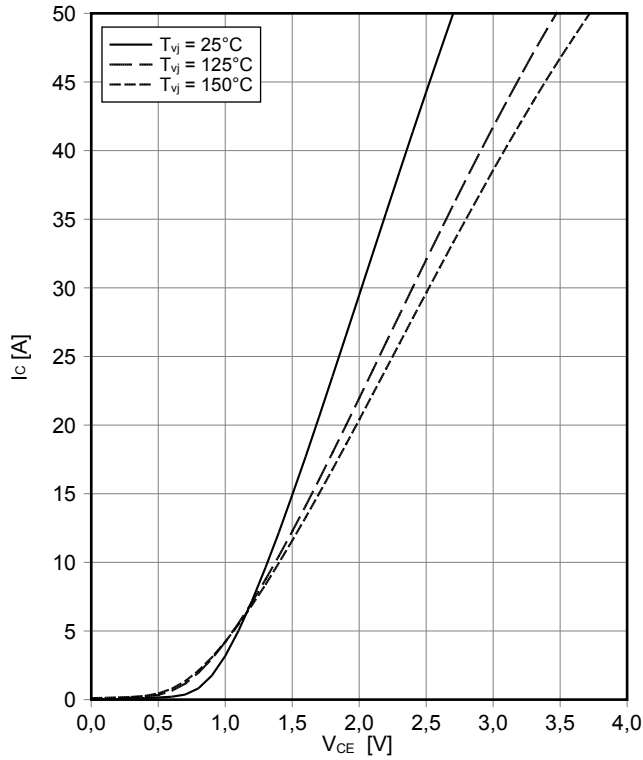

**Durchlasskennlinie der Diode, Brems-Chopper (typisch)**  
**forward characteristic of Diode, Brake-Chopper (typical)**

$I_F = f(V_F)$

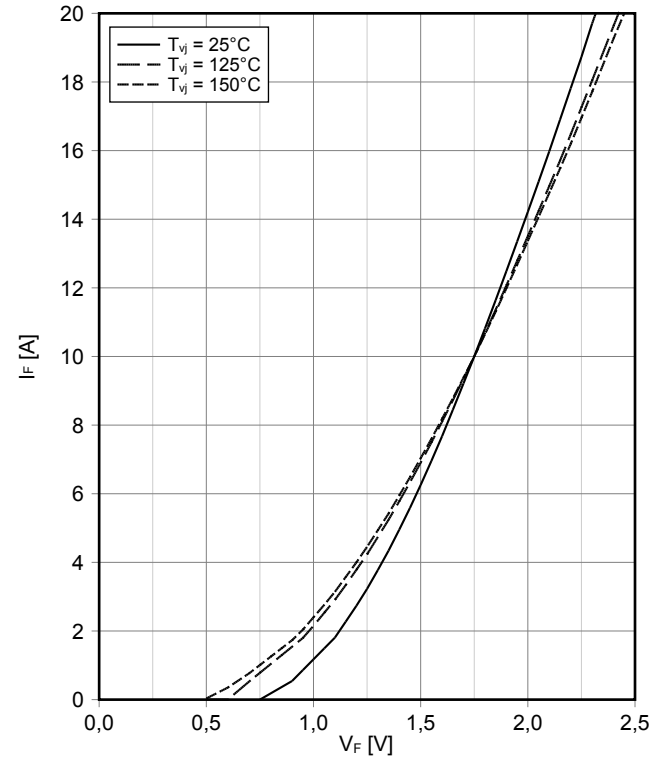

**NTC-Widerstand-Temperaturkennlinie (typisch)**  
**NTC-Thermistor-temperature characteristic (typical)**

$R = f(T)$

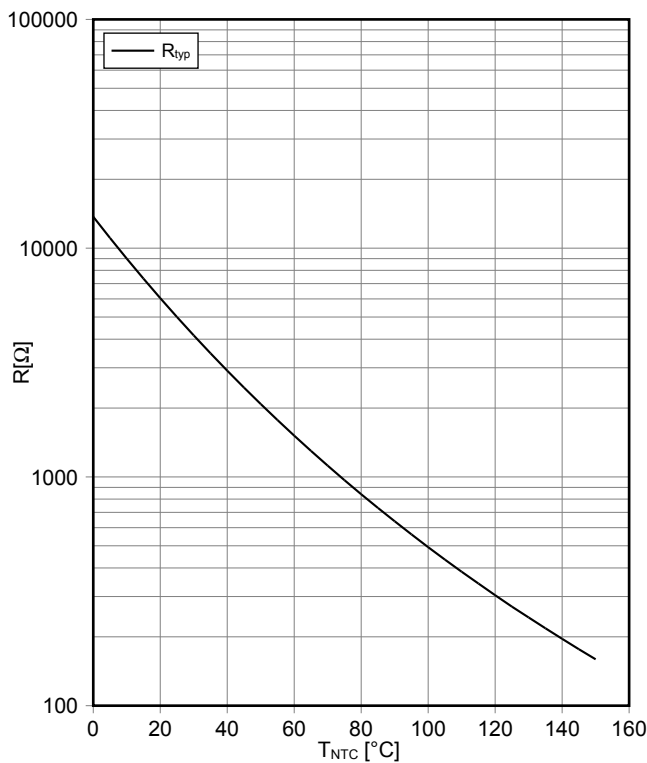

## Schaltplan / Circuit diagram

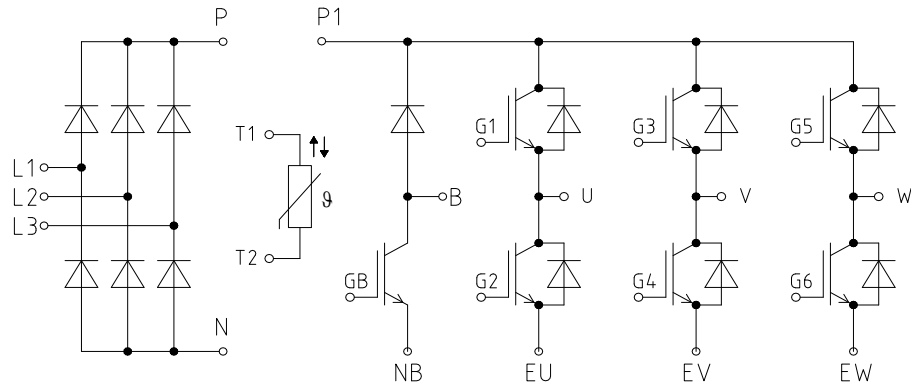

## Gehäuseabmessungen / Package outlines

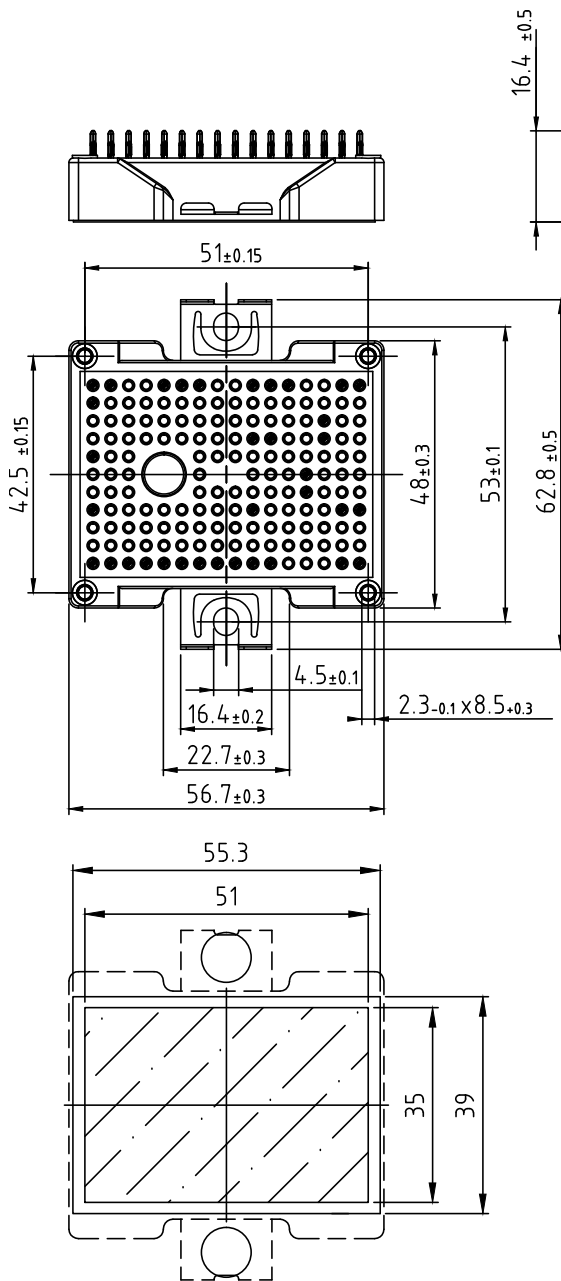

restricted area for Thermal Interface Material

- Pin-Grid 3.2mm
  - Tolerance of PCB hole pattern  $\varnothing 0.1$
  - Hole specification for contacts see AN 2009-01:
- Diameters of drill  $\varnothing$  1.15mm  
and copper thickness in hole 25-50 $\mu$ m

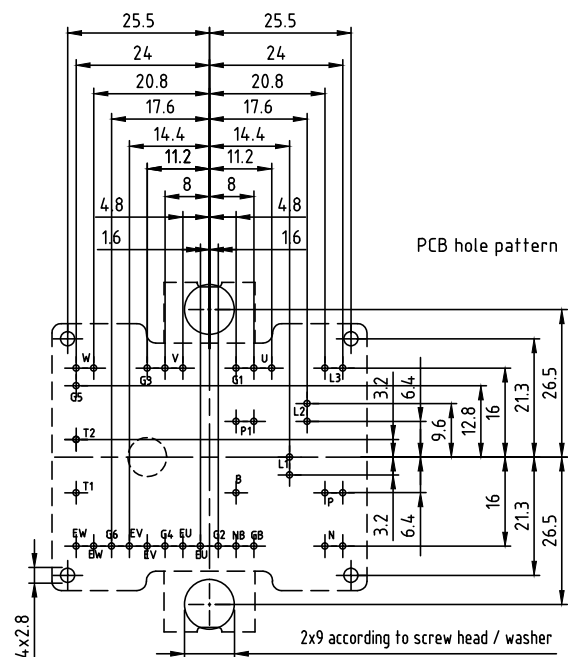

## Trademarks of Infineon Technologies AG

$\mu$ HVIC™,  $\mu$ IPM™,  $\mu$ PFC™, AU-ConvertIR™, AURIX™, C166™, CanPAK™, CIPOS™, CIPURSE™, CoolIDP™, CoolGaN™, COOLiR™, CoolMOS™, CoolSET™, CoolSiC™, DAVE™, DI-POL™, DirectFET™, DrBlade™, EasyPIM™, EconoBRIDGE™, EconoDUAL™, EconoPACK™, EconoPIM™, EiceDRIVER™, eupec™, FCOS™, GaNpowIR™, HEXFET™, HITFET™, HybridPACK™, iMOTION™, IRAM™, ISOFACE™, IsoPACK™, LEDrivIR™, LITIX™, MIPAQ™, ModSTACK™, my-d™, NovalithIC™, OPTIGA™, OptiMOS™, ORIGA™, PowIRaudio™, PowIRstage™, PrimePACK™, PrimeSTACK™, PROFET™, PRO-SIL™, RASIC™, REAL3™, SmartLEWIS™, SOLID FLASH™, SPOC™, StrongIRFET™, SuplIRBuck™, TEMPFET™, TRENCHSTOP™, TriCore™, UHVIC™, XHP™, XMC™

Trademarks updated November 2015

## Other Trademarks

All referenced product or service names and trademarks are the property of their respective owners.

Edition 2017-05-04

Published by  
Infineon Technologies AG  
81726 München, Germany

© 2017 Infineon Technologies AG.  
All Rights Reserved.

Do you have a question about this document?  
Email: [erratum@infineon.com](mailto:erratum@infineon.com)

## WICHTIGER HINWEIS

Die in diesem Dokument enthaltenen Angaben stellen keinesfalls Garantien für die Beschaffenheit oder Eigenschaften des Produktes ("Beschaffenhheitsgarantie") dar. Für Beispiele, Hinweise oder typische Werte, die in diesem Dokument enthalten sind, und/oder Angaben, die sich auf die Anwendung des Produktes beziehen, ist jegliche Gewährleistung und Haftung von Infineon Technologies ausgeschlossen, einschließlich, ohne hierauf beschränkt zu sein, die Gewähr dafür, dass kein geistiges Eigentum Dritter verletzt ist.

Des Weiteren stehen sämtliche, in diesem Dokument enthaltenen Informationen, unter dem Vorbehalt der Einhaltung der in diesem Dokument festgelegten Verpflichtungen des Kunden sowie aller im Hinblick auf das Produkt des Kunden sowie die Nutzung des Infineon Produktes in den Anwendungen des Kunden anwendbaren gesetzlichen Anforderungen, Normen und Standards durch den Kunden.

Die in diesem Dokument enthaltenen Daten sind ausschließlich für technisch geschultes Fachpersonal bestimmt. Die Beurteilung der Eignung dieses Produktes für die beabsichtigte Anwendung sowie die Beurteilung der Vollständigkeit der in diesem Dokument enthaltenen Produktdaten für diese Anwendung obliegt den technischen Fachabteilungen des Kunden.

Sollten Sie von uns weitere Informationen im Zusammenhang mit dem Produkt, der Technologie, Lieferbedingungen bzw. Preisen benötigen, wenden Sie sich bitte an das nächste Vertriebsbüro von Infineon Technologies ([www.infineon.com](http://www.infineon.com)).

## WARNHINWEIS

Aufgrund der technischen Anforderungen können Produkte gesundheitsgefährdende Substanzen enthalten. Bei Fragen zu den in diesem Produkt enthaltenen Substanzen, setzen Sie sich bitte mit dem nächsten Vertriebsbüro von Infineon Technologies in Verbindung.

Sofern Infineon Technologies nicht ausdrücklich in einem schriftlichen, von vertretungsberechtigten Infineon Mitarbeitern unterzeichneten Dokument zugestimmt hat, dürfen Produkte von Infineon Technologies nicht in Anwendungen eingesetzt werden, in welchen vernünftigerweise erwartet werden kann, dass ein Fehler des Produktes oder die Folgen der Nutzung des Produktes zu Personenverletzungen führen.

## IMPORTANT NOTICE

The information given in this document shall in no event be regarded as a guarantee of conditions or characteristics ("Beschaffenhheitsgarantie"). With respect to any examples, hints or any typical values stated herein and/or any information regarding the application of the product, Infineon Technologies hereby disclaims any and all warranties and liabilities of any kind, including without limitation warranties of non-infringement of intellectual property rights of any third party.

In addition, any information given in this document is subject to customer's compliance with its obligations stated in this document and any applicable legal requirements, norms and standards concerning customer's products and any use of the product of Infineon Technologies in customer's applications.

The data contained in this document is exclusively intended for technically trained staff. It is the responsibility of customer's technical departments to evaluate the suitability of the product for the intended application and the completeness of the product information given in this document with respect to such application.

For further information on the product, technology, delivery terms and conditions and prices please contact your nearest Infineon Technologies office ([www.infineon.com](http://www.infineon.com)).

## WARNINGS

Due to technical requirements products may contain dangerous substances. For information on the types in question please contact your nearest Infineon Technologies office.

Except as otherwise explicitly approved by Infineon Technologies in a written document signed by authorized representatives of Infineon Technologies, Infineon Technologies' products may not be used in any applications where a failure of the product or any consequences of the use thereof can reasonably be expected to result in personal injury.



Компания «ЭлектроПласт» предлагает заключение долгосрочных отношений при поставках импортных электронных компонентов на взаимовыгодных условиях!

Наши преимущества:

- Оперативные поставки широкого спектра электронных компонентов отечественного и импортного производства напрямую от производителей и с крупнейших мировых складов;
- Поставка более 17-ти миллионов наименований электронных компонентов;
- Поставка сложных, дефицитных, либо снятых с производства позиций;
- Оперативные сроки поставки под заказ (от 5 рабочих дней);
- Экспресс доставка в любую точку России;
- Техническая поддержка проекта, помощь в подборе аналогов, поставка прототипов;
- Система менеджмента качества сертифицирована по Международному стандарту ISO 9001;
- Лицензия ФСБ на осуществление работ с использованием сведений, составляющих государственную тайну;
- Поставка специализированных компонентов (Xilinx, Altera, Analog Devices, Intersil, Interpoint, Microsemi, Aeroflex, Peregrine, Syfer, Eurofarad, Texas Instrument, Miteq, Cobham, E2V, MA-COM, Hittite, Mini-Circuits, General Dynamics и др.);

Помимо этого, одним из направлений компании «ЭлектроПласт» является направление «Источники питания». Мы предлагаем Вам помощь Конструкторского отдела:

- Подбор оптимального решения, техническое обоснование при выборе компонента;
- Подбор аналогов;
- Консультации по применению компонента;
- Поставка образцов и прототипов;
- Техническая поддержка проекта;
- Защита от снятия компонента с производства.



#### Как с нами связаться

**Телефон:** 8 (812) 309 58 32 (многоканальный)

**Факс:** 8 (812) 320-02-42

**Электронная почта:** [org@eplast1.ru](mailto:org@eplast1.ru)

**Адрес:** 198099, г. Санкт-Петербург, ул. Калинина, дом 2, корпус 4, литера А.