

FLUKE®

741B/743B

Documenting Process Calibrator

Users Manual

PN 644788

June 1997 Rev.1, 3/98

© 1997, 1998 Fluke Corporation. All rights reserved. Printed in U.S.A.

All product names are trademarks of their respective companies.

LIMITED WARRANTY & LIMITATION OF LIABILITY

Each Fluke product is warranted to be free from defects in material and workmanship under normal use and service. The warranty period is three years and begins on the date of shipment. Parts, product repairs and services are warranted for 90 days. This warranty extends only to the original buyer or end-user customer of a Fluke authorized reseller, and does not apply to fuses, disposable batteries or to any product which, in Fluke's opinion, has been misused, altered, neglected or damaged by accident or abnormal conditions of operation or handling. Fluke warrants that software will operate substantially in accordance with its functional specifications for 90 days and that it has been properly recorded on non-defective media. Fluke does not warrant that software will be error free or operate without interruption.

Fluke authorized resellers shall extend this warranty on new and unused products to end-user customers only but have no authority to extend a greater or different warranty on behalf of Fluke. Warranty support is available if product is purchased through a Fluke authorized sales outlet or Buyer has paid the applicable international price. Fluke reserves the right to invoice Buyer for importation costs of repair/replacement parts when product purchased in one country is submitted for repair in another country.

Fluke's warranty obligation is limited, at Fluke's option, to refund of the purchase price, free of charge repair, or replacement of a defective product which is returned to a Fluke authorized service center within the warranty period.

To obtain warranty service, contact your nearest Fluke authorized service center or send the product, with a description of the difficulty, postage and insurance prepaid (FOB Destination), to the nearest Fluke authorized service center. Fluke assumes no risk for damage in transit. Following warranty repair, the product will be returned to Buyer, transportation prepaid (FOB Destination). If Fluke determines that the failure was caused by misuse, alteration, accident or abnormal condition of operation or handling, Fluke will provide an estimate of repair costs and obtain authorization before commencing the work. Following repair, the product will be returned to the Buyer transportation prepaid and the Buyer will be billed for the repair and return transportation charges (FOB Shipping Point).

THIS WARRANTY IS BUYER'S SOLE AND EXCLUSIVE REMEDY AND IS IN LIEU OF ALL OTHER WARRANTIES, EXPRESS OR IMPLIED, INCLUDING BUT NOT LIMITED TO ANY IMPLIED WARRANTY OF MERCHANTABILITY OR FITNESS FOR A PARTICULAR PURPOSE. FLUKE SHALL NOT BE LIABLE FOR ANY SPECIAL, INDIRECT, INCIDENTAL OR CONSEQUENTIAL DAMAGES OR LOSSES, INCLUDING LOSS OF DATA, WHETHER ARISING FROM BREACH OF WARRANTY OR BASED ON CONTRACT, TORT, RELIANCE OR ANY OTHER THEORY.

Since some countries or states do not allow limitation of the term of an implied warranty, or exclusion or limitation of incidental or consequential damages, the limitations and exclusions of this warranty may not apply to every buyer. If any provision of this Warranty is held invalid or unenforceable by a court of competent jurisdiction, such holding will not affect the validity or enforceability of any other provision.

Fluke Corporation
P.O. Box 9090
Everett WA 98206-9090
U.S.A

Fluke Europe B.V.
P.O. Box 1186
5602 B.D.
Eindhoven, The Netherlands

Table of Contents

Title	Page
Introduction.....	1
Standard Equipment.....	4
Safety Information	7
Getting Started Exercise	10
Operating Features	12
Input and Output Jacks.....	12
Keys	14
Display.....	17
Setting Up the Calibrator.....	19
Using the Strap and Bail.....	19
Charging the Battery.....	20
Battery Life	22
Preserving Battery Life	23
Using the Optional Battery Eliminator.....	23
Selecting the Display Language	24
Adjusting the Display Contrast.....	24

Displaying the Date and Time	24
Using the Backlight	26
Personalizing the Calibrator	26
Using Measure Mode	28
Measurement Ranges	28
Measuring Electrical Parameters	28
Testing Continuity	30
Measuring Pressure	30
Measuring Temperature	34
Using Thermocouples	34
Using Resistance-Temperature Detectors (RTDs)	37
Measurements in Percent of Scale	41
Linear-Output Transmitters	41
Square-Law Process Variables	41
Customizing mV Input Units	42
Damping Your Measurements	43
Using Source Mode	44
Sourcing Electrical Parameters	44
Simulating a 4 to 20 mA Transmitter	46
Supplying Loop Power	48
Sourcing Pressure	50
Simulating Thermocouples	53
Simulating RTDs	54
Sourcing in Percent of Scale	57
Linear-Responding Transmitters	57
Square-Law Process Variables	57
Stepping and Ramping the Output Value	58
Using Manual Step	58

Using Auto Step.....	59
Ramping the Output.....	60
Simultaneous Measure/Source	63
Calibrating a Process Instrument	66
Generating “As Found” Test Data.....	66
Adjusting the Transmitter.....	71
“As Left” Test Run	72
Test Comments	73
Calibrating a Delta-Pressure Flow Instrument.....	73
Calibrating a Limit Switch	74
Transmitter Mode	77
Memory Operations.....	79
Saving Results.....	79
Reviewing Memory	81
Data Logging (Model 743B Only)	81
Recording Min and Max Measurements	84
Running a Preloaded Task (743B only).....	84
Clearing Memory	84
Using the Built-in Calculator	85
Saving to and Recalling from the Registers.....	85
Using the Calculator to Set the Source Value	86
Quick Guide to Applications	86
Communicating with a PC (Model 743 Only).....	96
Maintenance.....	96
Replacing the Battery Pack	96
Internal Lithium Backup Battery.....	97
Cleaning the Calibrator.....	97
Calibration Data.....	97

In Case of Difficulty	97
Service Center Calibration or Repair	98
Replacement Parts.....	99
Accessories.....	100
Specifications.....	102
DC Voltage Measurement.....	103
AC Voltage Measurement	104
DC Current Measurement	105
Resistance Measurement.....	105
Continuity Testing	106
Frequency Measurement	106
DC Voltage Output.....	107
DC Current Output	108
Resistance Sourcing	109
Frequency Sourcing.....	110
Temperature, Thermocouples.....	111
Temperature, Resistance Temperature Detectors	114
Loop Power Supply.....	116
Top and Bottom Limits of Ranges with Auto Range On.....	117
General Specifications	119
Index	121

List of Tables

Table	Title	Page
1.	Summary of Source and Measure Functions	2
2.	Input/Output Jacks and Connectors	12
3.	Key Functions	15
4.	Battery Life	22
5.	Thermocouple Types Accepted.....	35
6.	RTD Types Accepted	37
7.	Simultaneous MEASURE/SOURCE Functions with Loop Power Disabled	64
8.	Simultaneous MEASURE/SOURCE Functions with Loop Power Enabled	65
9.	Replacement Parts.....	99

List of Figures

Figure	Title	Page
1.	Standard Equipment	5
2.	Definition of Symbols	8
3.	Jumper Connections for Demonstration.....	11
4.	Measure/Source Example	11
5.	Input/Output Jacks and Connectors	13
6.	Keys	14
7.	Elements of a Typical Display	18
8.	Using the Bail and Installing the Strap	19
9.	Removing the Battery and Using the Charger.....	21
10.	Electrical Measurement Connections	29
11.	Gage and Differential Pressure Modules	31
12.	Connections for Measuring Pressure	33
13.	Measuring Temperature with a Thermocouple.....	36
14.	Using a Jumper Correctly.....	39
15.	Measuring Temperature with an RTD	40
16.	Electrical Sourcing Connections	45
17.	Connections for Simulating a 4 to 20 mA Transmitter.....	47

18.	Connections for Supplying Loop Power.....	49
19.	Connections for Sourcing Pressure	52
20.	Connections for Simulating a Thermocouple.....	55
21.	Connections for Simulating an RTD	56
22.	Checking a Relay Output Trip Alarm	62
23.	Calibrating a Thermocouple Temperature Transmitter	68
24.	Limit Switch Terminology.....	74
25.	Calibrating a Chart Recorder.....	87
26.	Measuring Voltage Drop.....	87
27.	Monitoring AC Line Voltage and Frequency.....	88
28.	Calibrating a Current-to-Pressure (I/P) Transmitter	89
29.	Measuring the Output Current of a Transmitter.....	90
30.	Measuring a Precision Resistor	91
31.	Sourcing Resistance.....	91
32.	Checking a Switch	92
33.	Checking a Tachometer.....	92
34.	Calibrating a Pressure-to-Current (P/I) Transmitter	93
35.	Calibrating a mV to Current Transmitter	94
36.	Checking a Vortex Sheeding Flowmeter	95
37.	LCD Operating Environment Specification	120

Documenting Process Calibrator











Introduction

Fluke 741B and 743B Documenting Process Calibrators (hereafter referred to as the calibrator) are battery-powered, hand-held instruments that measure and source electrical and physical parameters. See Table 1. The calibrator lets you troubleshoot, calibrate, verify, and document your work on process instruments. Calibrator Specifications are near the back of the manual.

A summary of the measuring and sourcing functions provided by the 741B and 743B calibrators is shown in Table 1. In addition to these functions, the calibrator has the following features:

- General features:
 - An analog display to make it easy to read measurements when the input is unstable.
 - A setup option that lets you set the display to English, French, German, Italian, or Spanish.
 - A thermocouple (TC) input/output jack and internal isothermal block with automatic reference-junction temperature compensation. Or, you can manually enter an external temperature reference.
 - The ability to store results for later review.

Table 1. Summary of Source and Measure Functions

Function	Measure	Source
 dc V	0V to +/-300V	0V to 15V (10 mA max)
 ac V	0V to 300V rms, 20 Hz to 5 kHz	No sourcing
 Frequency	1 Hz to 1 kHz (100 mV to 300V rms) 1 kHz to 30 kHz (0.5V to 30V rms) 30 kHz to 50 kHz (1V to 30V rms)	0.1V to 10V pk zero-symmetric sine or square wave, 0 Hz to 50 kHz
 Resistance	0Ω to 11 kΩ	0Ω to 11 kΩ
 dc Current	0 mA to 110 mA	0 to 22 mA (28V max), sourcing or sinking
 Continuity	Beep and the word Short indicates continuity	No sourcing
 Thermocouple	Types E, N, J, K, T, B, R, S, C, L, or U	
 RTD	100Ω Platinum (3926) 100Ω Platinum (385) 120Ω Nickel (672) 200Ω Platinum (385) 500Ω Platinum (385) 1000Ω Platinum (385) 10Ω Copper (427) 100Ω Platinum (3916)	
Measure 2,3, or 4 wire.		
Source 2 wire.		
 Pressure	27 modules ranging from 0 to 10 in. H ₂ O (2.5 kPa) to 0 to 10,000 psi (69,000 kPa)	Note
 Loop Power	24 or 28V (22 mA max)	
Note: Use an external hand pump or other pressure source as a pressure stimulus for the source pressure function.		

The ability to automatically log up to 8,000 data points (Model 743B only).

A serial computer interface for uploading/downloading tasks, lists, and results (Model 743B only).

Automatic calibration procedures for transmitters and limit switches using split screen MEASURE/SOURCE mode.

Transmitter mode in which the calibrator can be configured to emulate the functions of a process instrument.

Built-in calculator with square-root function, and accessible registers containing measure and source values.

An optional bar code wand for entering alphanumeric characters (Model 743B only).

- Measuring features:

Damping (smoothing of the last several readings), with display indicator of damped status.

Display of measurements in engineering units, percent of scale, square-law inputs, or custom units.

The ability to capture and display minimum and maximum measured levels.

- Sourcing features:

The ability to set source values to engineering units, percent of scale, or square-law outputs.

Manual and automatic stepping, and an output ramp feature for testing limit switches. Trip detect is either a 1V change or a continuity status change (Open or Short) from one ramp increment to the next.

Unless stated otherwise, everything in this manual applies to both the Fluke 741B and 743B Documenting Process Calibrators.

For performance testing and calibration instructions order the *74X Series Calibration Manual* (PN 602505).

The phone number in the USA and Canada for replacement parts is: 1-800-526-4731.

For service help in the USA and Canada call a Fluke Service Center. For application or operation assistance on Fluke products call:

USA and Canada: 1-800-44-FLUKE
(1-800-443-5853)

Europe: +31 402-678-200

Japan: +81-3-3434-0181

Singapore: +65-*****-276-6196

Anywhere in the world: +1-425-356-5500

Or, visit Fluke's Web site at www.fluke.com.

Standard Equipment

The items listed below and shown in Figure 1 are included with your calibrator. If the calibrator is damaged or something is missing, contact the place of purchase immediately. To order replacement parts or spares, see the user-replaceable parts list at the end of this manual.

- TL24 industrial test leads (two sets)
- AC20 test clips (two sets)

- TP20 test probes (one set)
- BP7217 rechargeable nickel-cadmium battery pack
- BC7210 battery charger with Instruction Sheet
- Adjustable quick-release strap (PN 946769)
- Jumper for three-wire RTD measurement connections (two included, PN 944632)
- *741B/743B Users Manual*
 - English (PN 644788)
 - French (PN 649688)
 - German (PN 649696)
 - Italian (PN 649704)
 - Spanish (PN 649670)
- DPC/TRACK™ Software utility version with interface cable (9-pin male-female straight-through, PN 943738).

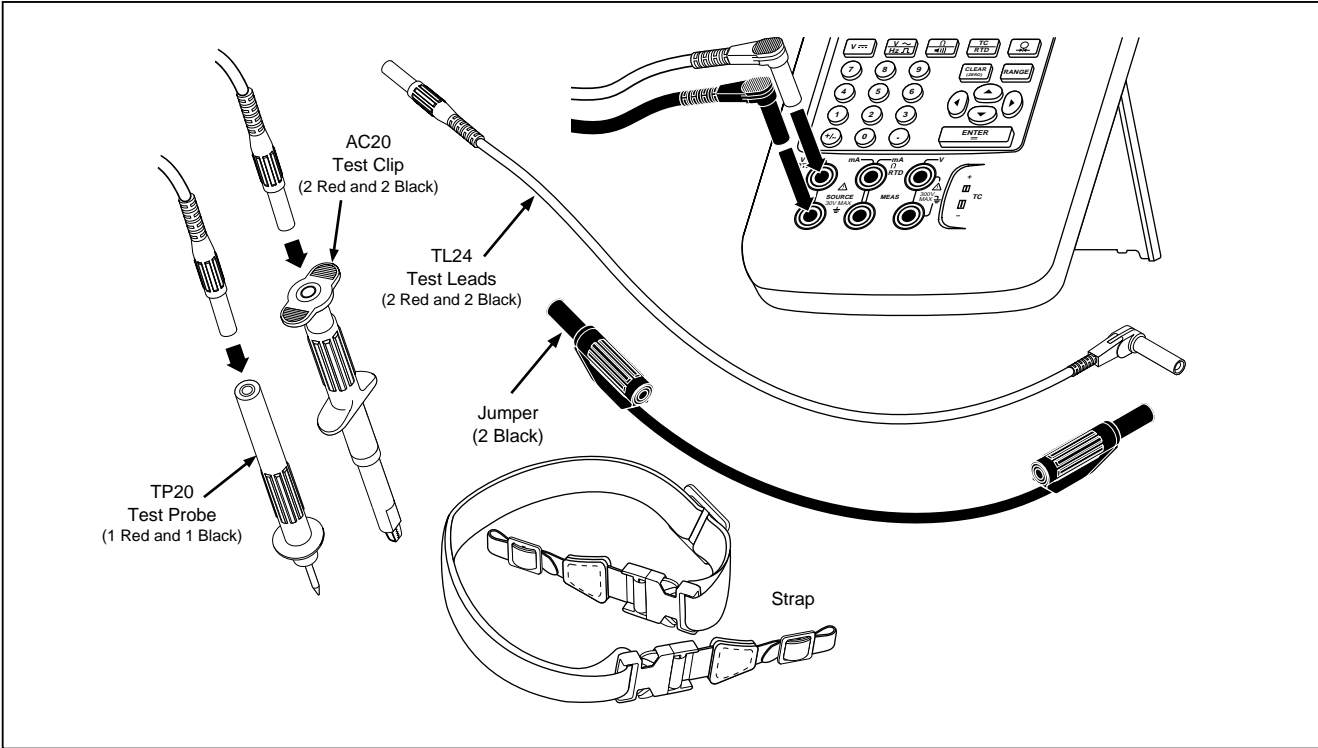

gj1f.eps

Figure 1. Standard Equipment

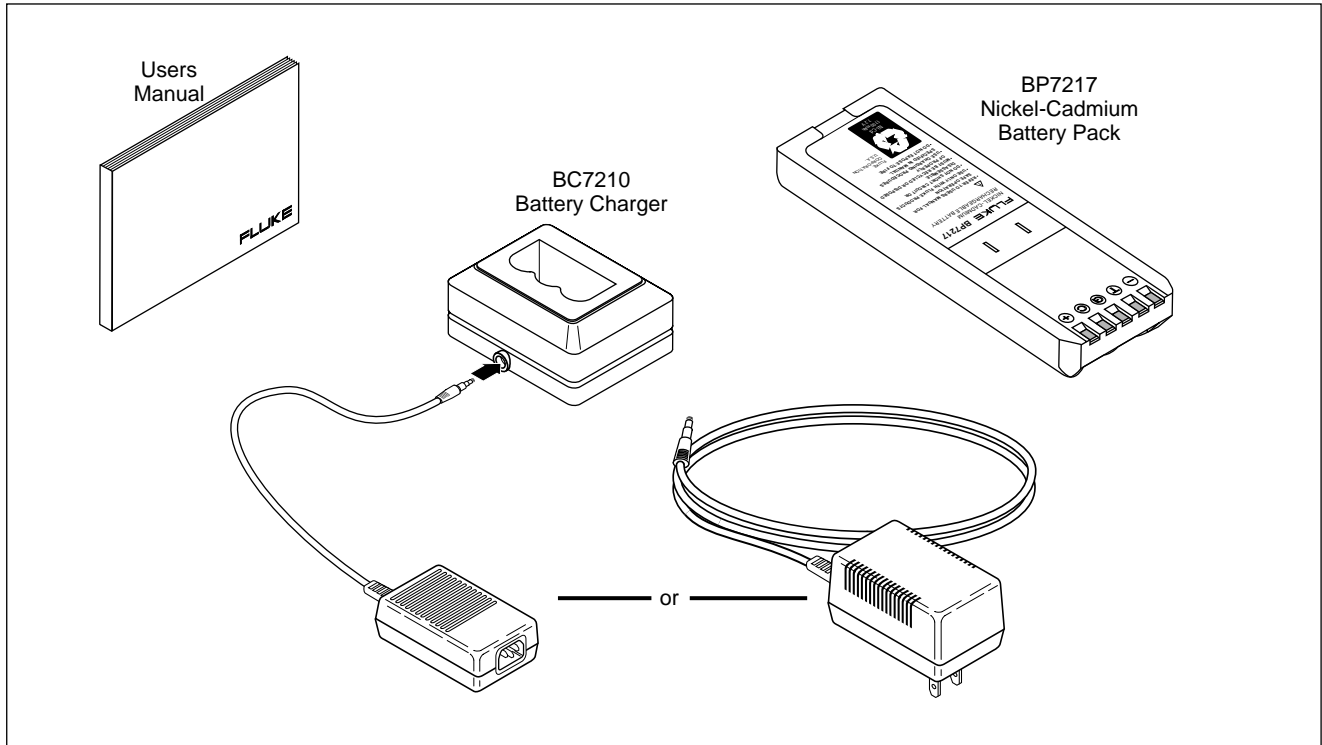

gj2f.eps











Figure 1. Standard Equipment (cont.)

Safety Information

This calibrator is designed and tested in accordance with CAN/CSA C22.2 No. 1010.1-92, ANSI/ISA S82.01-1994, UL3111 and EN610-10:1993. Use the calibrator only as specified in this manual, otherwise the protection provided by the calibrator may be impaired.

A Warning identifies conditions and actions that pose hazards to the user; a Caution identifies conditions and actions that may damage the calibrator or the equipment under test.

Symbols used on the calibrator and in this manual are explained in Figure 2.

	AC-Alternating Current		CAUTION see explanation in manual
	DC-Direct Current		Common (LO) Input equipotentiality
	Fuse		Equipment protected throughout by DOUBLE INSULATION or REINFORCED INSULATION
	Pressure		Conforms to relevant European Union directives.
	ON/OFF		Conforms to relevant Canadian Standards Association directives.
 Ni-Cd	Recycling	CAT II	Overvoltage (Installation) Category II per IEC 1010-1 refers to the level of Impulse Withstand Voltage protection provided. Typical locations include; Mains Wall outlets, local appliances and PORTABLE EQUIPMENT.

gj56f.eps

Figure 2. Definition of Symbols

To protect yourself, follow these safety guidelines:

- Do not use the calibrator if it is damaged. Before you use the calibrator, inspect the insulating cover. Look for cracks or missing plastic. Pay particular attention to the insulation surrounding the connectors.
- Disconnect the power and discharge all high-voltage capacitors in the equipment under test before testing resistance or continuity.
- Inspect the test leads for damaged insulation or exposed metal. Check test lead continuity. Replace damaged test leads before using the calibrator.

- Do not use the calibrator if it operates abnormally. Protection may be impaired. When in doubt, have the calibrator serviced.
- Select the proper function and range for your measurement.
- Use caution when working above 30V ac rms, 42V ac pk, or 60V dc. Such voltages pose a shock hazard.
- When using the probes, keep your fingers away from the probe contacts. Keep your fingers behind the finger guards on the probes.
- Connect the common test lead before you connect the live test lead. When you disconnect test leads, disconnect the live test lead first.
- Do not operate the calibrator around explosive gas, vapor, or dust.
- When using a pressure module, make sure the process pressure line is shut off and depressurized before you connect it to or disconnect it from the pressure module.
- Disconnect test leads before changing to another measure or source function.
- When servicing the calibrator, use only specified replacement parts.

Getting Started Exercise

The following is a brief getting started exercise that will make it easier to understand the instructions in the rest of the manual.

1. When you first unpack the calibrator, you will need to charge the battery. See Figure 9 and charge the battery for 2 hours.
2. Reinstall the battery in the calibrator.
3. Connect the calibrator's voltage output to its voltage input as follows: connect leftmost pair of jacks (V Ω RTD SOURCE) to the right most pair of jacks (V MEAS). (See Figure 3.)
4. Press **I** to turn on the calibrator. Press **↻** and **▼** to adjust the display contrast for the best looking display. The calibrator powers up in the dc voltage measurement function, and is taking readings on the V MEAS pair of input jacks.
5. Press **MEAS SOURCE** to switch to the SOURCE screen. The calibrator is still measuring dc voltage, and you can see the active measurements at the top of the display.
6. Press **V---** to select dc voltage sourcing. Press 5 on the keypad and **ENTER** to begin sourcing 5.0000V dc.
7. Now press **MEAS SOURCE** to go to the split-screen, simultaneous MEASURE/SOURCE mode. The calibrator is simultaneously sourcing dc volts and measuring dc volts. You can see the measurement readings in the top window, and the active source value in the bottom window as shown in Figure 4.

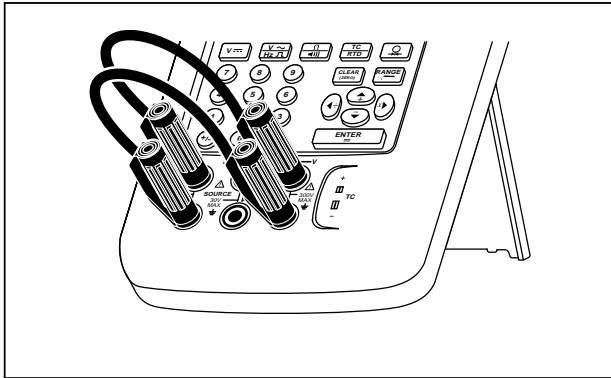

gj3f.eps

Figure 3. Jumper Connections for Demonstration

MEASURE			
4.9999 V=			
SOURCE			
5.0000 V=			
As Found	Step	Save	More Choices

gj4s.eps

Figure 4. Measure/Source Example

Operating Features

Input and Output Jacks

Figure 5 shows the calibrator input and output jacks. Table 2 explains their use.

Table 2. Input/Output Jacks and Connectors

No.	Name	Description
1	Battery Eliminator jack	Jack for the Model BE9005 Battery Eliminator. Use the battery eliminator for bench-top applications where ac line power is available. This input does not charge the battery.
2	⚠ SERIAL PORT (743B Only)	Connects the calibrator to an RS-232 serial port on a personal computer.
3	Pressure module connector	Connects the calibrator to a pressure module.
4	TC input/output	Jack for measuring or simulating thermocouples. This jack accepts a miniature polarized thermocouple plug with flat, in-line blades spaced 7.9 mm (0.312 in) center to center.
5, 6	⚠ MEAS V jacks	Input jacks for measuring voltage, frequency, or three- or four-wire RTDs (Resistance Temperature Detectors).
7, 8	⚠ SOURCE mA, MEAS mA Ω RTD jacks	Jacks for sourcing or measuring current, measuring resistance and RTDs, and supplying loop power.
9,10	⚠ SOURCE V Ω RTD jacks	Output jacks for sourcing voltage, resistance, frequency, and for simulating RTDs.

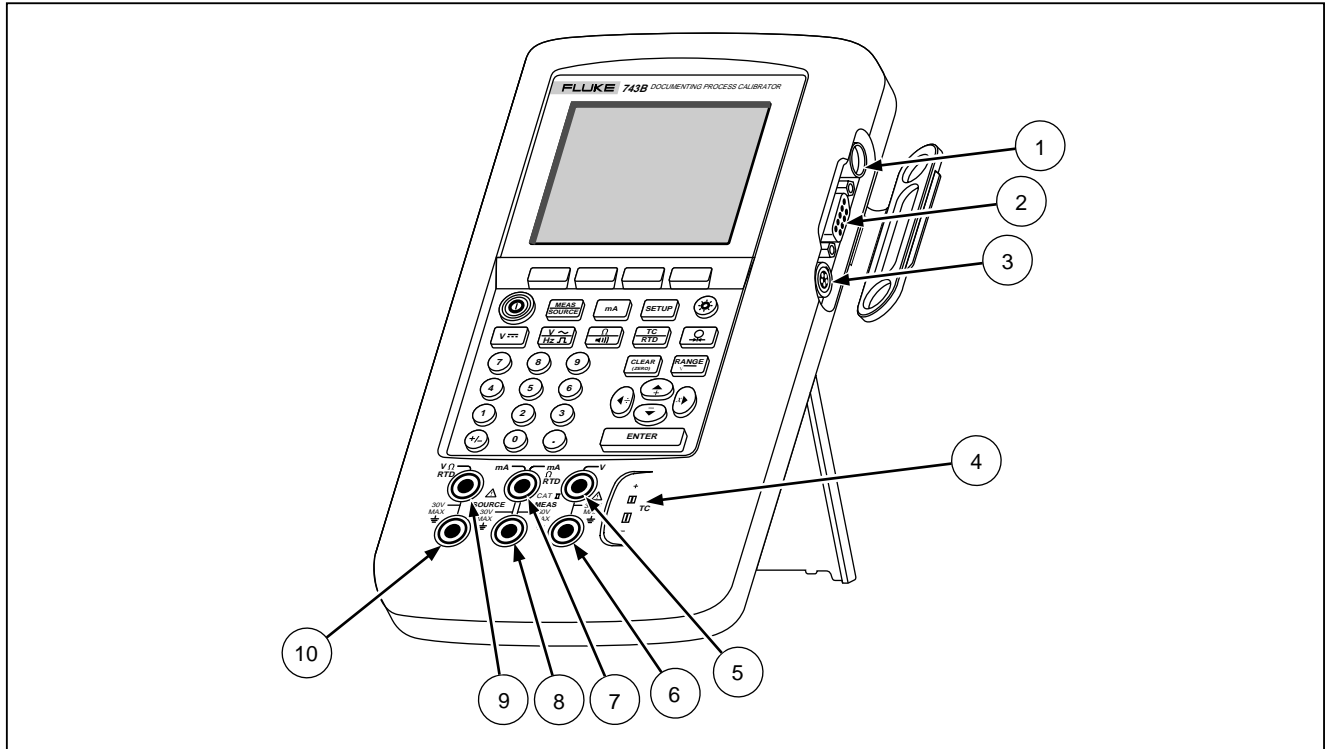

ki05f.eps

Figure 5. Input/Output Jacks and Connectors

Keys

Figure 6 shows the calibrator keys and Table 3 explains their functions. The softkeys are the four unmarked blue keys just below the display. Softkey functions are defined by the labels that appear above the softkey during operation. Softkey labels and other display text are shown in this manual in bold type, for example, **Choices**.

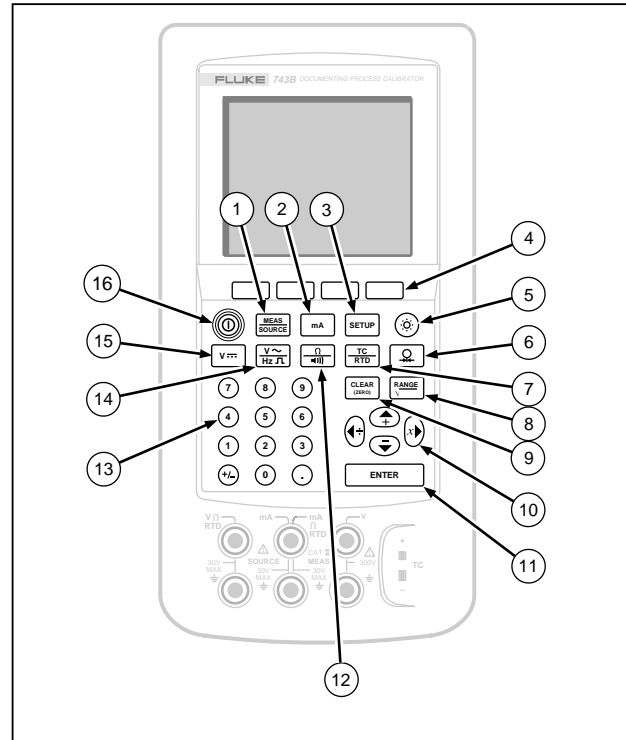

ki06f.eps

Figure 6. Keys

Table 3. Key Functions



















No.	Name	Description
1	 key	Cycles the calibrator through MEASURE, SOURCE, and MEASURE/SOURCE modes.
2	 key	Selects mA (current) measure or source function. For loop power on/off, go to the Setup mode.
3	 key	Enters and exits Setup mode to modify operating parameters.
4	Softkeys	Perform the function defined by the label above each key on the display.
5	 key	Turns the backlight on and off.
6	 key	Selects the pressure measurement or sourcing function.
7	 key	Selects TC (thermocouple) or RTD (resistance temperature detector) measurement or sourcing functions.
8	 key	Toggles between autorange and locked range, and increments range. Each time you press  , the calibrator locks on the next range. Press this key again for 2 seconds to resume autorange. In calculator mode, provides the square root function.
9	 key	Clears a partial data entry, or zeros the output when in the SOURCE mode. When using a pressure module, zeros the pressure module reading.

Table 3. Key Functions (cont.)

No.	Name	Description
10	 ,  ,  , and  keys	<ul style="list-style-type: none"> Adjust the display contrast. Make choices from lists on the display. Increase or decrease the source level when using the step feature. In calculator mode, provide arithmetic functions (+ - ÷ ×).
11	 key	Terminates a numeric entry when setting a source value, or confirms your choice in a list. In calculator mode, provides the equals arithmetic operator (=).
12	 key	Toggles between resistance and continuity functions in MEASURE mode, or selects the resistance function in SOURCE mode.
13	Numeric keypad	Used whenever a numeric entry is required.
14	 key	Toggles between ac voltage and frequency functions in MEASURE mode, or selects frequency output in SOURCE mode.
15	 key	Selects the dc voltage function in MEASURE mode, or selects dc voltage in SOURCE mode.
16	 key	Turns the power on and off.

Display

Figure 7 shows the features of a typical display. The display shown is MEASURE mode. Near the top of the display is “Source Off.” This is the area of the display that shows what is happening in the other mode (SOURCE or MEASURE). The other parts of the display are as follows:

- **Status Bar:** shows the time and date (if set in Setup mode), and shows the status of Loop Power, Battery Save, and Backlight Timeout; all of which are set in Setup mode. The low battery and backlight on annunciators also appear here.
- **Mode Indicator:** Shows whether the calibrator is in MEASURE or SOURCE mode. In split screen MEASURE/SOURCE mode, there is a Mode Indicator for each window.
- **Measured Value:** Shows the measured value in your choice of engineering units or percent of scale.
- **Range Status:** Shows whether Auto Range is on, and what range is currently being used.
- **Custom Units Indicator:** Shows that the displayed units are custom. The original engineering units of the measure or source function are not displayed. The value may also be scaled.
- **Secondary Value:** Shows the measure or source value in original engineering units whenever scaling or custom units are active.

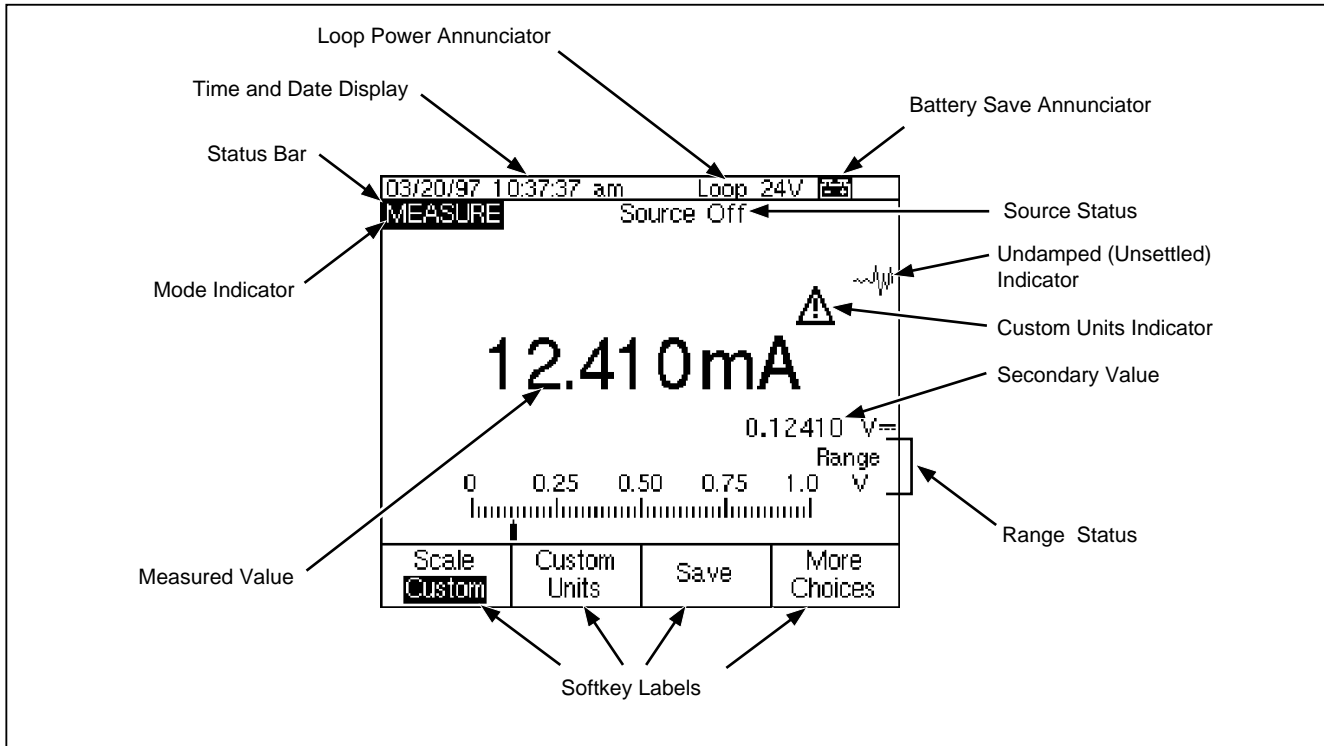

gj7c.eps

Figure 7. Elements of a Typical Display

Setting Up the Calibrator

Using the Strap and Bail

After you unpack the calibrator, attach its carrying strap as shown in Figure 8. You can adjust the strap as necessary to hang the calibrator on any sturdy

support. Figure 8 also shows you how to open the bail to stand the calibrator at a comfortable viewing angle for benchtop use.

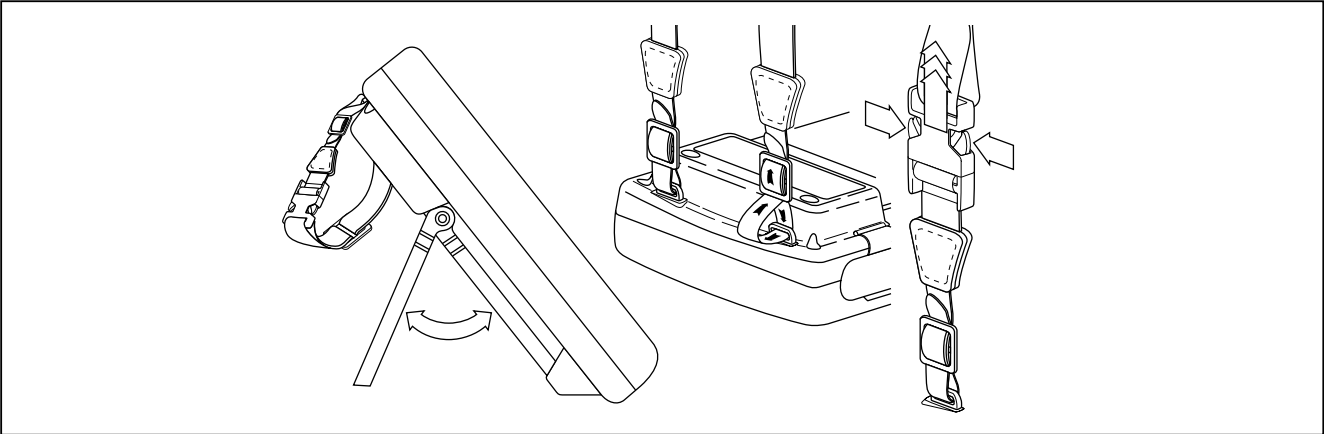

gj8f.eps

Figure 8. Using the Bail and Installing the Strap

Charging the Battery

⚠ Before you use the calibrator for the first time, charge its battery pack for 2 hours in the external battery charger.

Figure 9 shows how to remove the battery. Remove the battery door and tap the calibrator with your hand to get the battery out. Place the battery in the charger and connect the charger to line power. The charger automatically senses line voltage and adjusts itself accordingly.

A discharged battery is fully charged in 2 hours or less in fast-charge mode (steady indicator light on the charger). Full charge is maintained after that

time in trickle-charge mode (blinking indicator light on the charger). Switching between charging modes is automatic. You can leave the battery pack on trickle charge indefinitely without damage.

Note

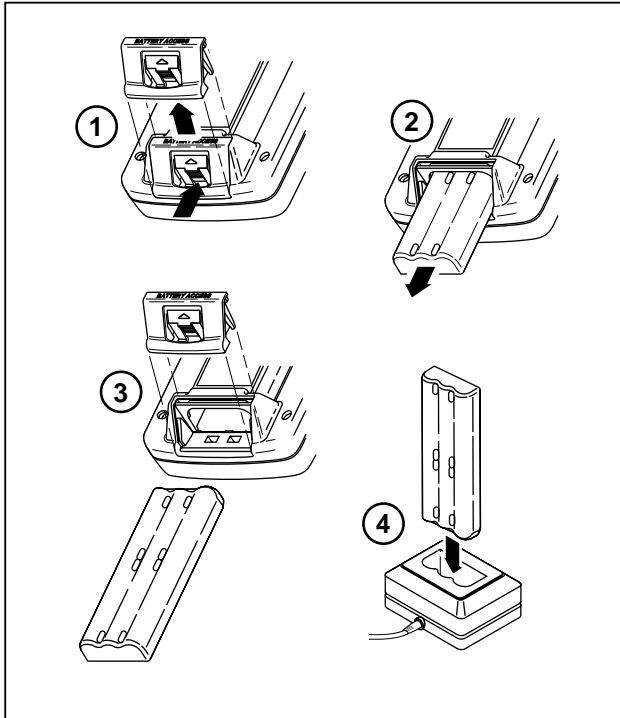

When you remove a charged battery from the charger, wait for the blinking indicator to go off before you insert a discharged battery. It takes about 2 seconds for the battery charger to reset.



gj9f.eps

Figure 9. Removing the Battery and Using the Charger

Battery Life

Table 4 shows the operating time for a new, fully charged battery pack. Calibrator performance is guaranteed to meet specifications until the low battery annunciator  located at the top right side of the display appears and the beeper beeps every 4 seconds. When the  annunciator appears, stop using the calibrator and charge the battery. If you have a fully charged spare battery, exchange it with the low battery.

⚠ Warning

To avoid false readings, which could lead to possible electric shock or personal injury, replace the battery as soon as the battery indicator () appears.











The battery normally lasts for up to 1000 charge / discharge cycles. To replace the battery, refer to “Replacing the Battery” later in this manual for instructions. For longest battery life and best performance, wait for  to appear before you charge the battery.

Table 4. Battery Life

Operating Modes	Backlight Off	Backlight On
Measure, continuous	6.5 Hours	6 Hours
Measure and source, with loop power on, continuous	3.5 Hours	3 Hours
Typical intermittent operation	>8 Hours	>8 Hours

Preserving Battery Life

An optional **Auto Battery Save** feature turns the calibrator off after a selected idle time. The default setting for **Auto Battery Save** is **Off**. When **Auto Battery Save** is **On**, the  symbol shows in the upper right corner of the display. The setting is preserved after you turn off the power. Auto Battery Save works the same when using the battery eliminator. Turn on the **Auto Battery Save** feature as follows:

1. Press .
2. Press  to highlight **Off** following **Auto Battery Save**.
3. Press  or the **Choices** softkey.
4. Press  to highlight **On**, then press .
5. To accept the timeout period shown on the display, you can finish here. Press **Done** to exit Setup mode and do not go on to step 6.
6. To change the timeout period, press  to highlight the timeout period following **Battery Save Timeout**.
7. Press  or the **Choices** softkey.
8. Enter your choice of timeout period in minutes (accepted range: 1 to 120 minutes).
9. Press the **Done** softkey.
10. Press the **Done** softkey or  to exit Setup mode.

Using the Optional Battery Eliminator

Caution

To avoid damage to the calibrator, use only Fluke Model BE9005 Series Battery Eliminator, available from your Fluke representative.

Where ac power is available, you can use the optional Fluke Model BE9005 Battery Eliminator to conserve battery power. When the battery eliminator is used, the battery is internally disconnected, and can be removed from the calibrator. The battery eliminator does not charge the battery.

The battery eliminator is handy for troubleshooting process instruments on the workbench, and for long-term data logging. When you calibrate an instrument, you will get best results using battery power.

Selecting the Display Language

The calibrator displays information in five languages. English is the default. To change the display language, proceed as follows:

1. Press **SETUP**.
2. Press the third softkey from the left twice.
3. Press **▼** three times.
4. Press **ENTER**.
5. Press **▲** or **▼** to highlight your choice of language.
6. Press **ENTER** to confirm your choice. The language you choose is the power-up default.
7. Press **SETUP** to exit Setup mode.

Adjusting the Display Contrast

Press **▲** or **▶** to increase contrast. Press **◀** or **▼** to decrease contrast. When the **▲** and **▼** keys are being used to select an item from a list, for example in Setup mode, use the **◀** and **▶** keys. In calculator mode, all four direction keys are used for arithmetic functions.

Displaying the Date and Time

The date and time can be shown at the top of the display during normal operation. In Setup mode you can turn this date and time display on or off. You can also control the format used to display the date and time. You should set the calendar and clock whether or not you use the date and time display, since a timestamp is applied to all saved results.

Proceed as follows to set up the time and date displays:

1. Press **SETUP**.
2. Press the **Next Page** softkey. The display appears as follows:

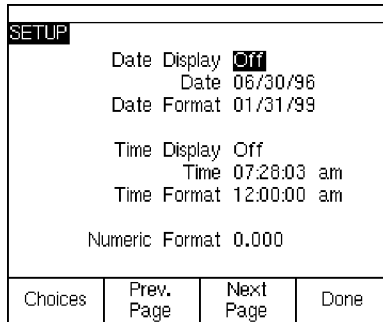

gj38s.eps

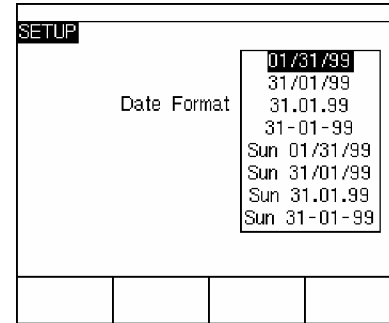

3. Use the **▲** and **▼** keys to move the cursor to the parameter you want to change, then press **ENTER** or the **Choices** softkey to choose a setting for that parameter. For example, the following display appears after you select **Date Format**:











gj39s.eps

4. Press **▲** or **▼** to move the cursor to the desired date format.
5. Press **ENTER** to go back to the **SETUP** display.
6. Make another selection or press the **Done** softkey or **SETUP** to save your settings and exit Setup mode.

Using the Backlight



Press  to toggle the display backlight on and off. When the backlight is on, the  symbol shows at the top of the display. You can minimize battery usage by setting the calibrator to turn the display backlight off automatically. When the backlight is on and Auto Backlight Off is activated, the  symbol shows at the top of the display. To automatically turn off the backlight after a set time, proceed as follows:

1. Press .
2. Press  to highlight **Off** following **Auto Backlight Off**.
3. Press  or the **Choices** softkey.
4. Press  to highlight **On**, then press .
5. To accept the timeout period shown on the display, press **Done** to exit, and do not go on to step 6.
6. To change the timeout period, press  to highlight the timeout period following **Backlight Timeout**.

7. Press  or the **Choices** softkey.
8. Enter your choice of timeout period in minutes (accepted range: 1 to 120 minutes).
9. Press the **Done** softkey.
10. Press the **Done** softkey or  to exit Setup mode.

Personalizing the Calibrator

You can load your name or some other alphanumeric identifier into the calibrator to be displayed at power-up and in saved results. Proceed as follows to load an identifier:

1. Press .
2. Press **Next Page** twice.
3. Press  to move the cursor to the same line as **ID**.

4. Press or the **Choices** softkey. The display appears as follows:

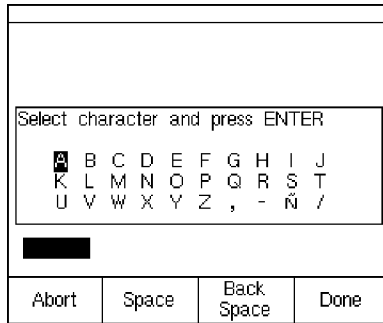

gj40s.eps

5. The **ID** string is shown at the bottom of the boxed area. To erase a character, press the **Back Space** softkey. To erase the whole string, press .
6. Press , , , or , to select a character, then press . Use the numeric keypad if you want to enter a number.
7. Repeat step 6 until you are satisfied with the **ID** string appearing in the window.
8. Press the **Done** softkey.
9. Press the **Done** softkey or to exit Setup mode.

Using Measure Mode

Note

To achieve best noise rejection and highest accuracy performance, do not use the battery eliminator, and tie all three common jacks together.

The operating mode (i.e., MEASURE, SOURCE) is shown in a reverse-video bar on the display. If the calibrator is not in MEASURE mode, press  until MEASURE is shown. You must be in MEASURE mode to change any of the MEASURE parameters.

Measurement Ranges





The calibrator normally changes to the appropriate measurement range automatically. The lower right side of the display shows either “Range” or “Auto Range” depending on the range status. Auto Range switch points are shown in the specifications at the

end of this manual. When you press the  key, the range is locked. Press it again to cycle to and lock on the next higher range. Press it and hold it for two seconds to revert to Auto Range.

If the range is locked, overrange inputs produce a display of - - - - -. In Auto Range, out of range inputs produce a display of ! ! ! ! ! !.

Measuring Electrical Parameters

When you turn on the calibrator, it powers up in the dc voltage measurement function. Figure 10 shows electrical measurement connections. To select an electrical measurement function from either SOURCE or MEASURE/SOURCE mode, first press  for MEASURE mode, then proceed as follows:

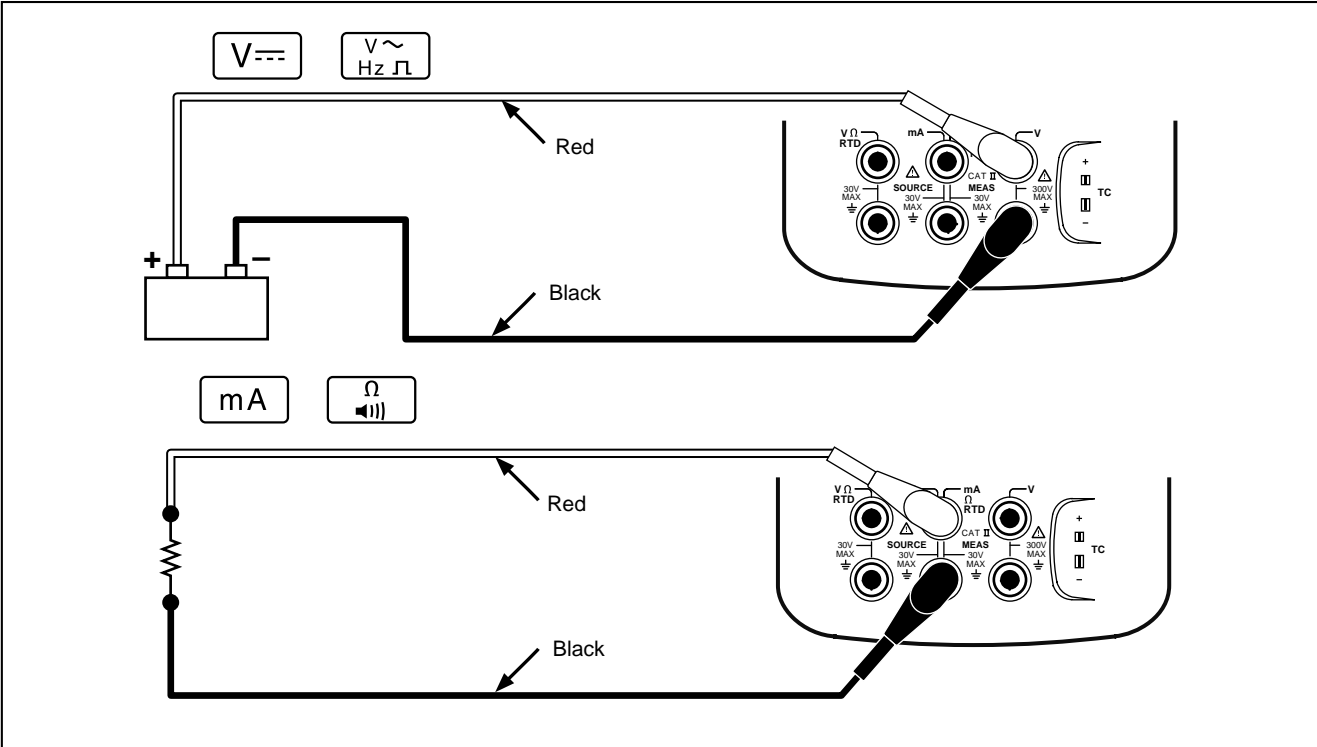

1. Press  for current,  for dc voltage,  once for ac voltage or twice for frequency, or  for resistance.



gj10f.eps

Figure 10. Electrical Measurement Connections



Note

When measuring frequency, you are prompted to select a frequency range. If you expect the frequency you are measuring to be below 20 Hz, press  to select the lower frequency range, then press .

2. Connect the test leads as shown in Figure 10, depending on the measurement function.

Testing Continuity

When testing continuity, the beeper sounds and the word **Short** appears on the display when the resistance between the Ω MEAS jack and its common jack is less than 25 Ω . The word **Open** appears when the resistance is greater than 400 Ω . Proceed as follows to test continuity:

1. Remove power from the circuit to be tested.
2. If necessary, press  for MEASURE mode.
3. Press  twice so that **Open** appears.
4. Connect the calibrator to the circuit to be tested as Figure 10 shows.

Measuring Pressure

Many ranges and types of pressure modules are available from Fluke. See “Accessories” near the back of this manual. Before you use a pressure module, read its Instruction Sheet. The modules vary in how you use them, how you zero them, what types of process pressure media are allowed, and accuracy specification.

Figure 11 shows gage and differential modules. Differential modules also work in gage mode by leaving the low fitting open to atmosphere.

To measure pressure, attach the appropriate pressure module for the process pressure to be tested as described in the module’s Instruction Sheet.

Proceed as follows to measure pressure:

Warning

To avoid a violent release of pressure in a pressurized system, shut off the valve and slowly bleed off the pressure before you attach the pressure module to the pressure line.

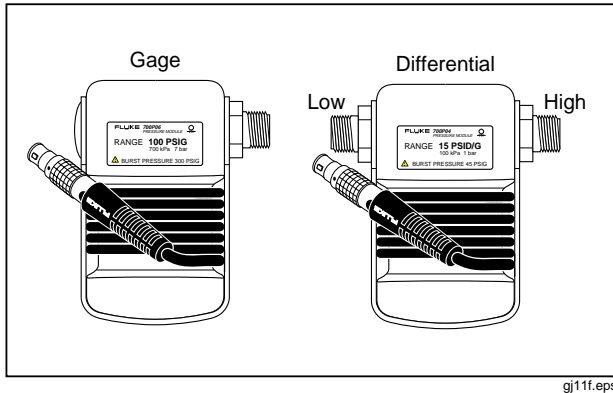









Figure 11. Gage and Differential Pressure Modules

Caution

To avoid mechanically damaging the pressure module, never apply more than 10 ft.-lb. of torque between the pressure module fittings, or between the fittings and the body of the module. Always apply appropriate torque between the pressure module fitting and connecting fittings or adapters.

To avoid damaging the pressure module from overpressure, never apply pressure above the rated maximum printed on the pressure module.

To avoid damaging the pressure module from corrosion, use it only with specified materials. Refer to the printing on the pressure module or the pressure module instruction sheet for the acceptable material compatibility.

1. Connect a pressure module to the calibrator as shown in Figure 12. The threads on the pressure modules accept standard ¼ NPT pipe fittings. Use the supplied ¼ NPT to ¼ ISO adapter if necessary.
2. Press  for MEASURE mode.
3. Press . The calibrator automatically senses which pressure module is attached and sets its range accordingly.
4. Zero the pressure module as described in the module's Instruction Sheet. Modules vary in zeroing procedures depending on module type. You **MUST** perform this step before you execute a task that sources or measures pressure.
5. If desired, you can change pressure display units to psi, mHg, inHg, mH₂O, inH₂O@, inH₂O@60°F, ftH₂O, bar, g/cm², or Pa. Metric units (kPa, mmHg, etc.) are shown in Setup mode in their base units (Pa, mHg, etc.). Change the pressure display units as follows:
 - a. Press .
 - b. Press **Next Page** twice.
 - c. Press  or the **Choices** softkey with the cursor on **Pressure Units**.
 - d. Select the pressure units with  or .
 - e. Press .
 - f. Press **Done**.

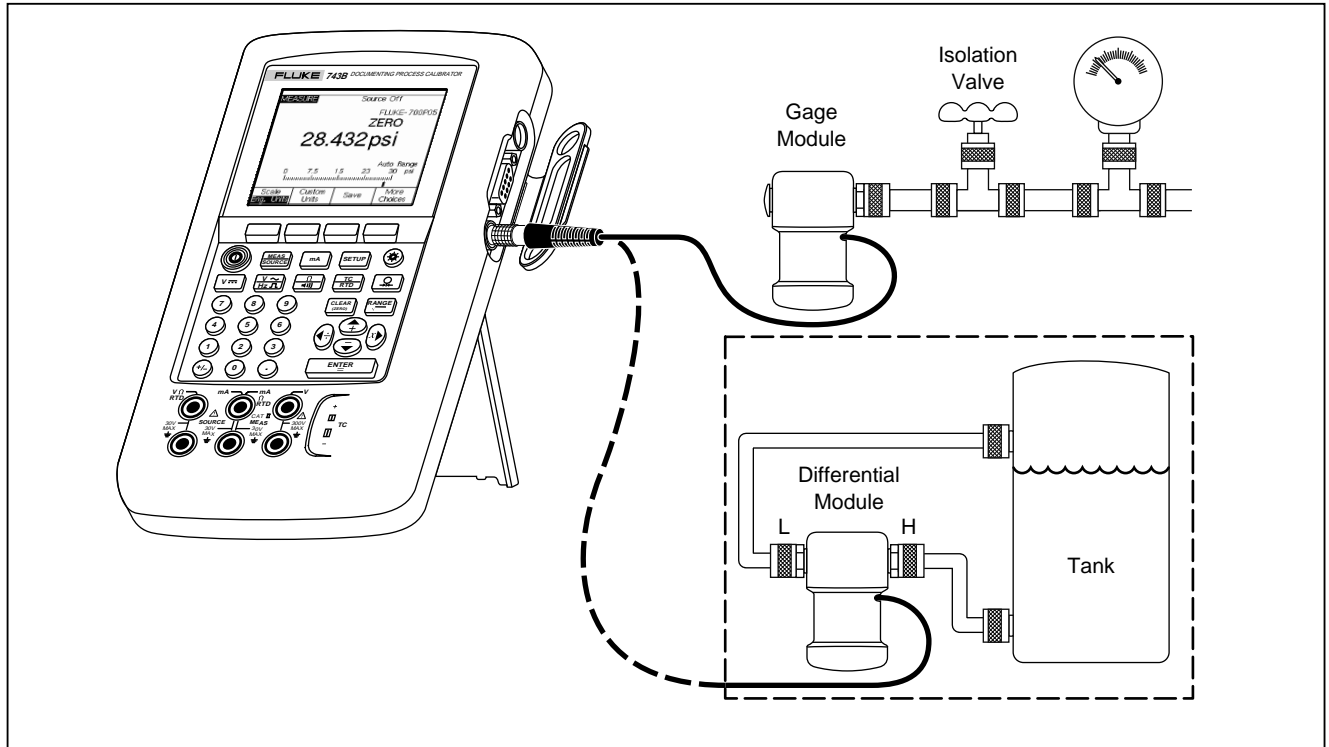

ki12c.eps

Figure 12. Connections for Measuring Pressure

Measuring Temperature

Using Thermocouples

The calibrator supports eleven standard thermocouples, each identified with an alpha character: E, N, J, K, T, B, R, S, C, L, or U. Table 5 summarizes the ranges and characteristics of the supported thermocouples.

To measure temperature using a thermocouple, proceed as follows:

1. Attach the thermocouple leads to the appropriate TC miniplug, then to the TC input/output as shown in Figure 13. *One pin is wider than the other. Do not try to force a miniplug in the wrong polarization.*

Note

If the calibrator and the thermocouple plug are at different temperatures, wait one minute or more for the connector temperature to stabilize after you plug the miniplug into the TC input/output.

1. If necessary, press  for MEASURE mode.













2. Press . The display prompts you to select the thermocouple type.
3. Select the desired thermocouple type using the  or  followed by .
4. If necessary, you can change between °C or °F **Temperature Units** as follows:
 - a. Press .
 - b. Press the **Next Page** softkey twice.
 - c. Use the  and  keys to move the cursor to the desired parameter. Then press either  or the **Choices** softkey to choose a setting for that parameter.
 - d. Press  or  to move the cursor to the desired setting.
 - e. Press  to go back to the  display.
 - f. Press the Done softkey or  to exit Setup mode.
5. If necessary, you can change between **ITS-90** or **IPTS-68 Temperature Scale** in Setup mode. The procedure is the same as steps a-f above.

Table 5. Thermocouple Types Accepted

Type	Positive Lead Material	Positive Lead (H) Color		Negative Lead Material	Specified Range (°C)
		ANSI*	IEC**		
E	Chromel	Purple	Violet	Constantan	-250 to 1000
N	Ni-Cr-Si	Orange	Pink	Ni-Si-Mg	-200 to 1300
J	Iron	White	Black	Constantan	-210 to 1200
K	Chromel	Yellow	Green	Alumel	-270 to 1372
T	Copper	Blue	Brown	Constantan	-250 to 400
B	Platinum (30% Rhodium)	Gray		Platinum (6% Rhodium)	600 to 1820
R	Platinum (13% Rhodium)	Black	Orange	Platinum	-20 to 1767
S	Platinum (10% Rhodium)	Black	Orange	Platinum	-20 to 1767
C ***	Tungsten (5% Rhenium)	White		Tungsten (26% Rhenium)	0 to 2316
L (DIN J)	Iron			Constantan	-200 to 900
U (DIN T)	Copper			Constantan	-200 to 600

*American National Standards Institute (ANSI) device negative lead (L) is always red.
 **International Electrotechnical Commission (IEC) device negative lead (L) is always white.
 *** Not an ANSI designation but a Hoskins Engineering Company designation.

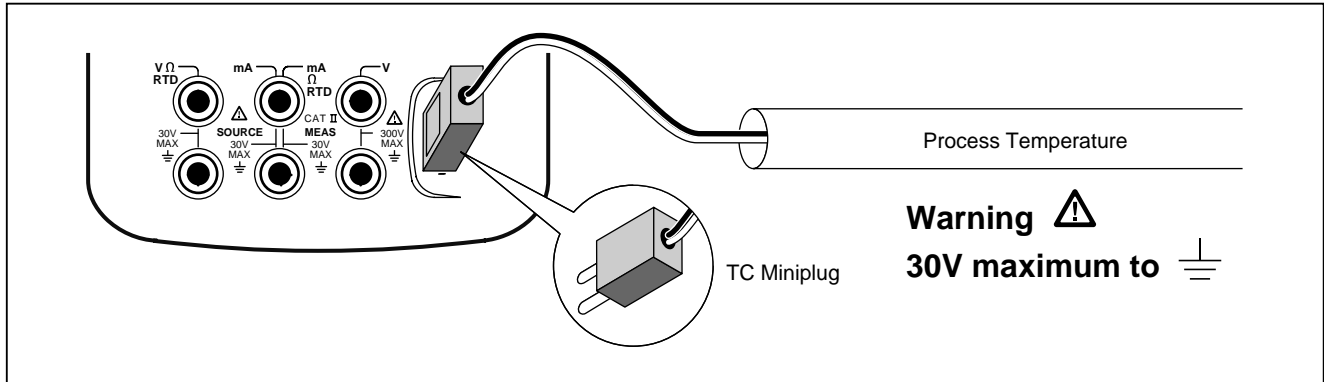

Figure 13. Measuring Temperature with a Thermocouple

gj12f.eps

Using Resistance-Temperature Detectors (RTDs)

The calibrator accepts RTD types shown in Table 6. RTDs are characterized by their resistance at 0°C (32°F), which is called the “ice point” or R_0 . The most common R_0 is 100Ω. Most RTDs come in a three-









terminal configuration. The calibrator accepts RTD measurement inputs in two-, three-, or four-wire connections as shown in Figure 15. A four-wire configuration provides the highest measurement precision, and two-wire provides the lowest measurement precision.

Table 6. RTD Types Accepted

RTD Type	Ice Point (R_0)	Material	α	Range (°C)
Pt100 (3926)	100Ω	Platinum	0.003926Ω/°C	-200 to 630
*Pt100 (385)	100Ω	Platinum	0.00385Ω/°C	-200 to 800
Ni120 (672)	120Ω	Nickel	0.00672Ω/°C	-80 to 260
Pt200 (385)	200Ω	Platinum	0.00385Ω/°C	-200 to 630
Pt500 (385)	500Ω	Platinum	0.00385Ω/°C	-200 to 630
Pt1000 (385)	1000Ω	Platinum	0.00385Ω/°C	-200 to 630
Cu10 (427)	9.035Ω **	Copper	0.00427Ω/°C	-100 to 260
Pt100 (3916)	100Ω	Platinum	0.003916Ω/°C	-200 to 630

*Per IEC 751-Standard **10Ω @ 25°C

To measure temperature using an RTD input, proceed as follows:

1. If necessary, press  for MEASURE mode.
2. Press  twice so that **Select RTD Type** shows.
3. Press  or  to select the desired RTD type.
4. Press .
5. Press  or  to select a 2-, 3-, or 4- wire connection.
6. Attach the RTD to input jacks as the display or Figure 15 shows. Use the supplied jumper between the mA Ω RTD MEAS low jack and the V MEAS low jack as shown if you are using a 3-wire connection.
7. Press .

Caution

Do not force a dual banana plug between any two jacks in the horizontal orientation. Doing so will damage the jacks. Use the supplied jumper wire when needed for RTD measurements. You can use a dual banana plug in the vertical orientation. See Figure 14.

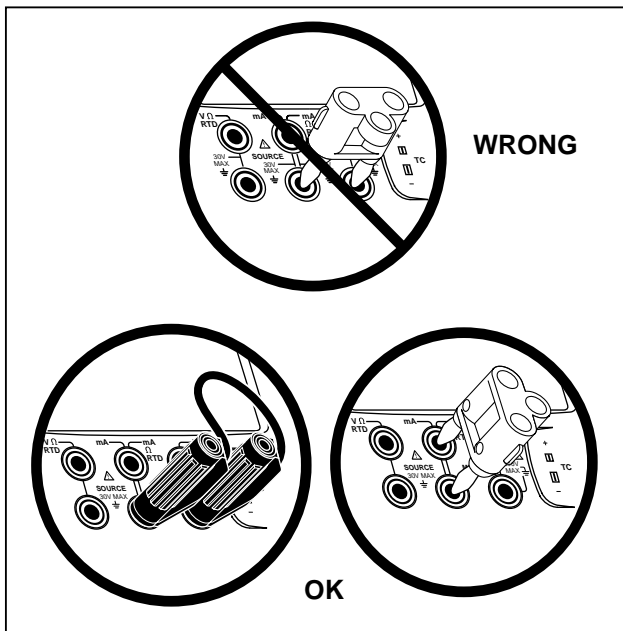

gj14f.eps

Figure 14. Using a Jumper Correctly

8. If necessary, you can change between °C or °F temperature units in Setup mode as follows:
 - a. Press **SETUP**.
 - b. Press the **Next Page** softkey twice.
 - c. Use the **▲** and **▼** keys to move the cursor to the parameter you which to change, then press **ENTER** or the **Choices** softkey to choose a setting for that parameter.
 - d. Press **▲** or **▼** to move the cursor to the desired setting.
 - e. Press **ENTER** to go back to the **SETUP** display.
 - f. Press the **Done** softkey or **SETUP** to exit Setup mode.
9. If necessary, you can change between **ITS-90** or **IPTS-68 Temperature Scale** in Setup mode. The procedure is the same as steps a through f above.

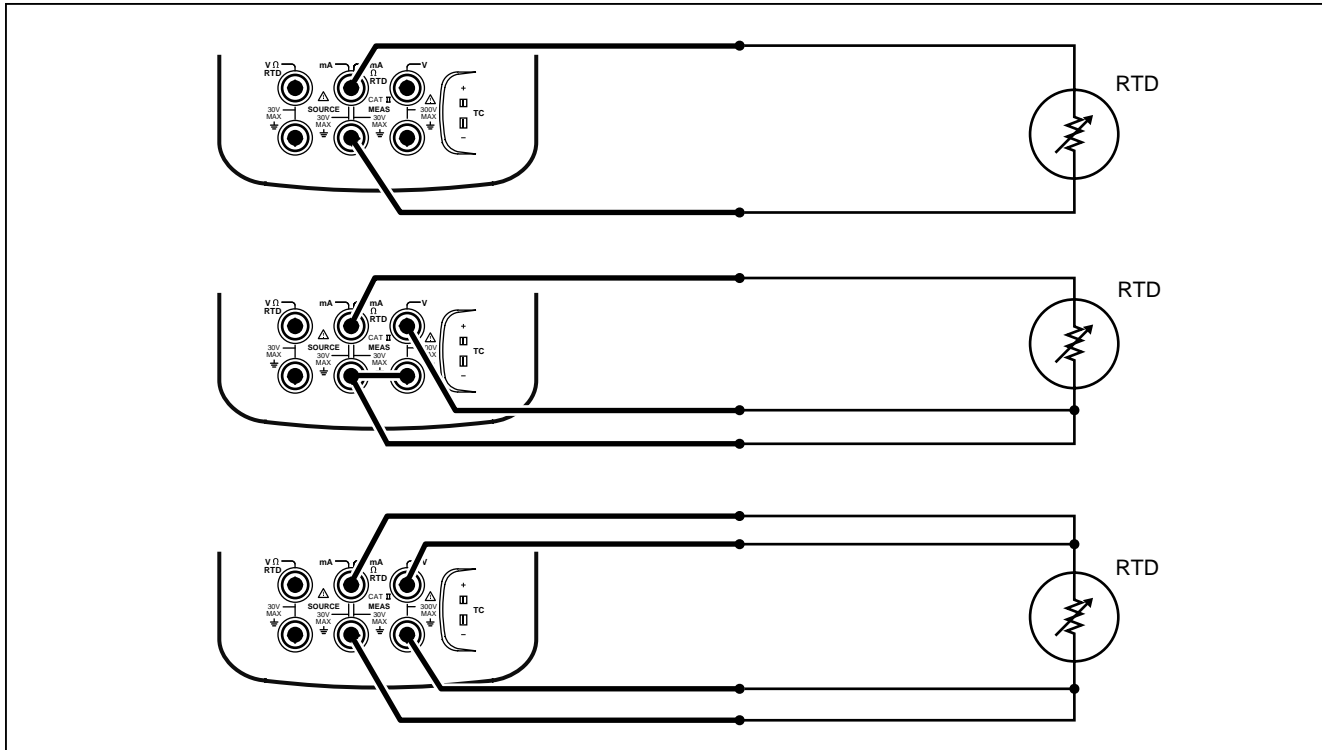









gj15f.eps

Figure 15. Measuring Temperature with an RTD

Measurements in Percent of Scale

This feature lets you scale the measurements in accordance with a particular process instrument's response. Percent of scale works for linear-output transmitters or square-law transmitters such as differential pressure transmitters that report flow rate.

Linear-Output Transmitters







1. If necessary, press  for MEASURE mode.
2. Select a measurement function (, , , , or ) as previously described.
3. Press the **Scale** softkey.
4. Use the numeric keypad to enter the 0% of scale value (**0% Value**).
5. Press .
6. Use the numeric keypad to enter the 100% of scale value (**100% Value**).
7. Press .
8. Leave **Mode** set to %.





9. Press the **Done** softkey.

Percent of scale remains in effect until you press the **Scale** softkey again or change to another measurement function.

Square-Law Process Variables

When you select $\sqrt{\quad}$ within scaling, the calibrator takes the square root of its input and displays the measurement in percent. For example, when connected to the output of a delta-pressure transmitter, the calibrator reading is proportional to flow rate.

1. If necessary, press  for MEASURE mode.
2. Select a measurement function (, , , , or ) as previously described.
3. Press the **Scale** softkey.
4. Use the numeric keypad to enter the 0% of scale value (**0% Value**).

5. Press .
 6. Use the numeric keypad to enter the 100% of scale value (**100% Value**).
 7. Press .
 8. Set **Mode** to $\sqrt{\quad}$.
 9. Press .
 10. Press the **Done** softkey.
1. When measuring the millivolt output of the accessory, press the **Custom Units** softkey.
 2. Enter the name of the custom units (up to four characters), for example **PH** (for pH), using the alphanumeric entry window, then press .
 3. Press the **+10** or **×10** softkey as many times as you need to select the proper scaling, then press .

Percent of scale remains in effect until you press the **Scale** softkey again or change to another measurement function. Set scaling **Mode** to **Eng. Units** to return to normal operation.

Customizing mV Input Units

The calibrator works with any measurement accessory that converts an input parameter to a linear millivolt output. Use the **Custom Units** feature for this purpose. After you name and scale a custom measurement unit, the display shows both the new scaled custom unit and the actual measured parameter.

Proceed as follows to set up a custom unit:

While **Custom Units** are active, the  symbol shows on the display to the right of the custom unit. Once you have programmed the custom measurement unit, the custom unit is available for calibration procedures in split-screen MEASURE/SOURCE mode. To cancel **Custom Units**, press the **Custom Units** softkey again.

Warning

To avoid possible electric shock, when using Custom Units, always refer to the Secondary Value displayed below and to the right of the main display for the actual value of the measurement in native engineering units.

Damping Your Measurements

The calibrator normally applies a software filter to dampen measurements in all functions except continuity. The specifications assume that damping is turned on. The damping method is a running average of the last several measurements. Fluke recommends that you leave damping on. Turning damping off may be useful when measurement response is more important than accuracy or noise reduction. If you want to turn off damping, press the **More Choices** softkey twice, then press the **Dampen** softkey so that **Off** appears. Press **Dampen** again to turn damping back on. The default state is **On**.

Note











If a measurement falls outside a random noise window, a new average is started. If damping is turned off, or until measurements are fully damped, the  symbol is displayed.

Using Source Mode

The operating mode (i.e., MEASURE, SOURCE) is shown in a reverse-video bar on the display. If the calibrator is not in SOURCE mode, press  until SOURCE is shown. You must be in SOURCE mode to change any of the SOURCE parameters.

Sourcing Electrical Parameters

To select an electrical sourcing function, proceed as follows:

1. Connect the test leads as shown in Figure 16, depending on the source function.
2. Press  for current,  for dc voltage,  for frequency, or  for resistance.
3. Enter the desired output value, then press . For example, to source 5.0V dc, press     .



Note

If you are sourcing frequency, respond to the display prompt to select a zero-symmetric sine or positive square wave. The amplitude you specify is p-p amplitude.

4. To change the output value enter a new value and press .

Note

If you are sourcing current, wait for the  symbol to go out before you use the output.

5. To set the output value to 0 in the present source function, press .
6. To turn off sourcing completely, press  twice.

Note

*Use the source current function to drive a current loop. This is different than the loop power function in which the calibrator is powering a process instrument. To source loop power, use the **Loop Power** function accessible from Setup mode.*

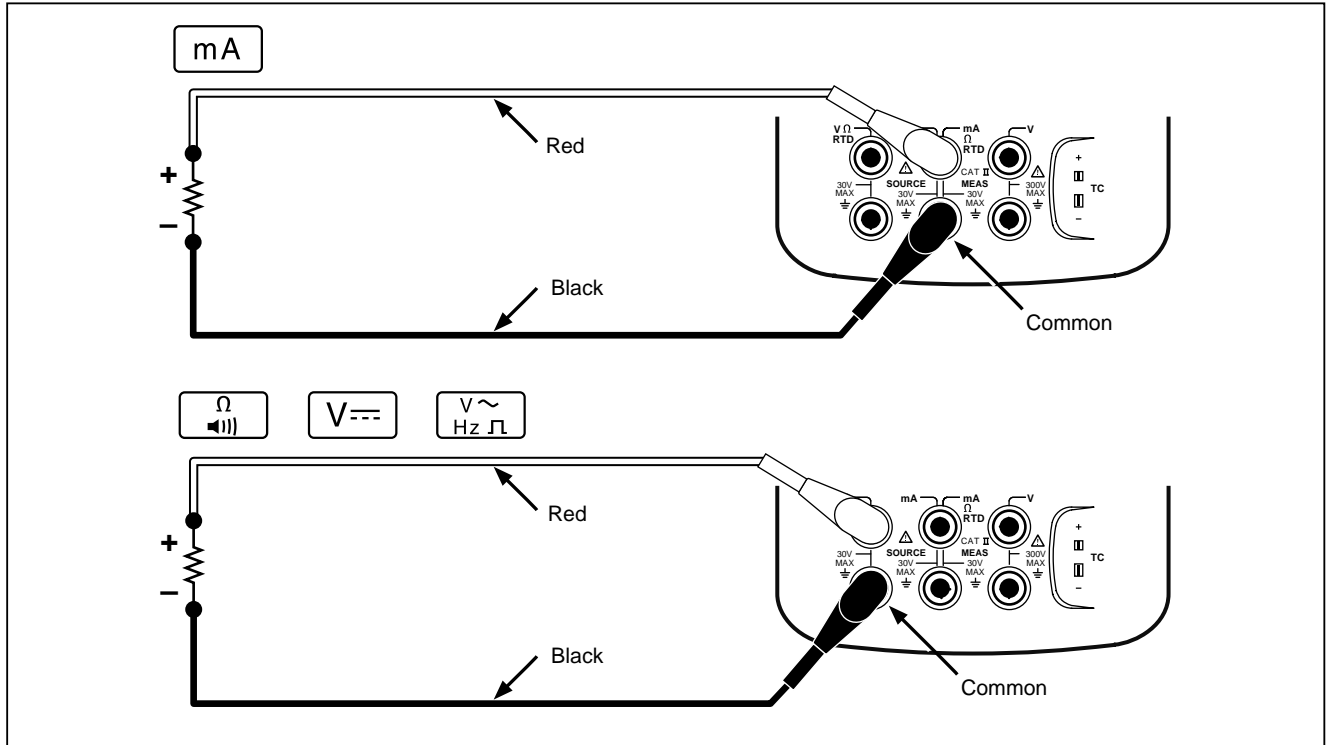

gj16f.eps

Figure 16. Electrical Sourcing Connections

Simulating a 4 to 20 mA Transmitter

You can configure the calibrator as a load on a current loop through the SOURCE mA function. When you press the  key in SOURCE mode, the display prompts you to select **Source mA** or **Simulate Transmitter**. When you **Source mA** the calibrator is sourcing current, and when you **Simulate Transmitter** the calibrator is sourcing a variable resistance to regulate current to the specified value. Connect an external loop supply to the positive (top) mA jack as shown in Figure 17.

Note

Also see “Transmitter Mode,” in which the calibrator can be set up to temporarily take the place of a two-wire process transmitter.

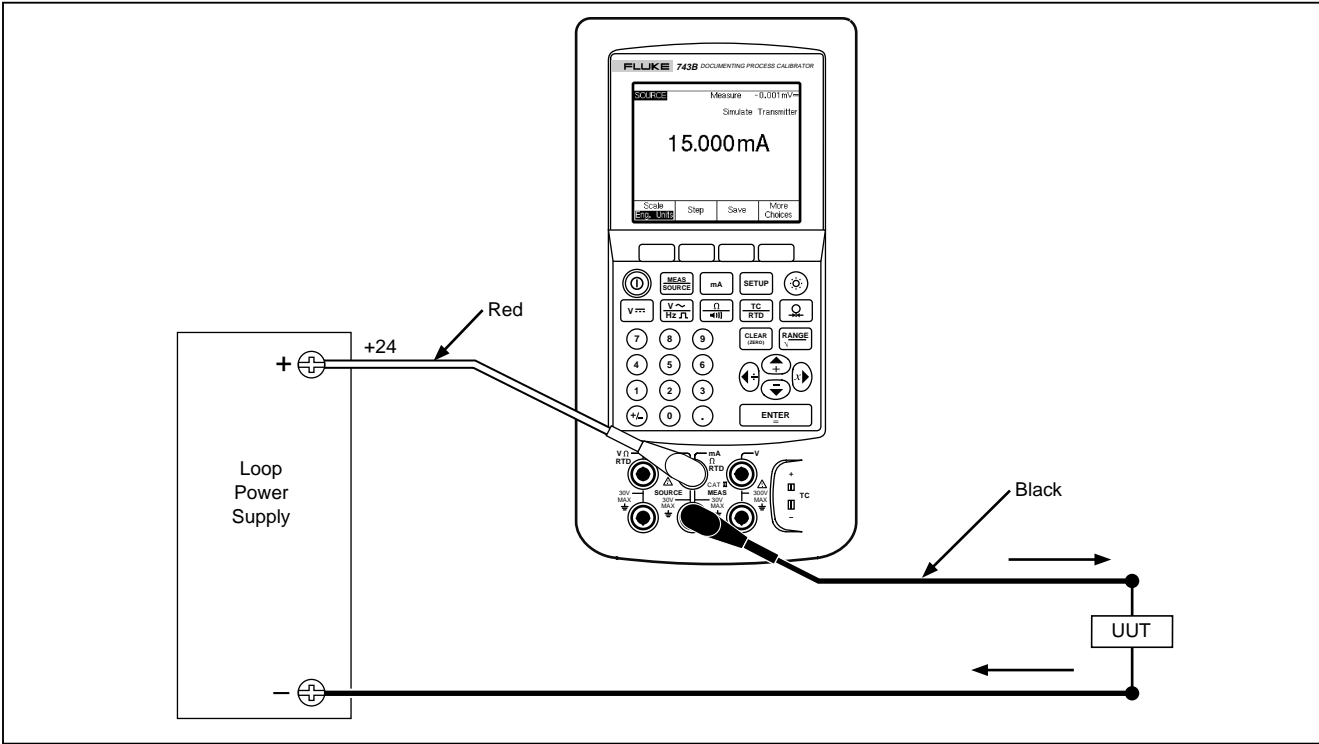

ki17c.eps



Figure 17. Connections for Simulating a 4 to 20 mA Transmitter

Supplying Loop Power

The calibrator supplies loop power at 28V or 24V dc. The 28V setting supplies enough current for two or three 4-20 mA devices on the loop in addition to the two-wire transmitter but uses more battery power. Use the 24V setting if there are two or fewer devices on the loop in addition to the two-wire transmitter. (Each device on a typical 4- to 20-mA loop has a resistance of 250 Ω , thus dropping 5V at 20 mA. A typical transmitter must have 11V minimum in order to operate correctly at its top end.)

When loop power is enabled, the mA (middle column) jacks are dedicated to sourcing and measuring the current loop. This means that the SOURCE mA, measure RTD, and measure Ω functions are not available (see Table 8, later in this manual.)

Connect the calibrator in series with the instrument current loop as Figure 18 shows. Proceed as follows to source loop power:

1. Press for Setup mode.
2. Note that following **Loop Power, Disabled** is highlighted. Press .
3. Use the  or  arrow keys to select **Enabled 24V** or **Enabled 28V**.
4. Press .
5. Press the **Done** softkey.

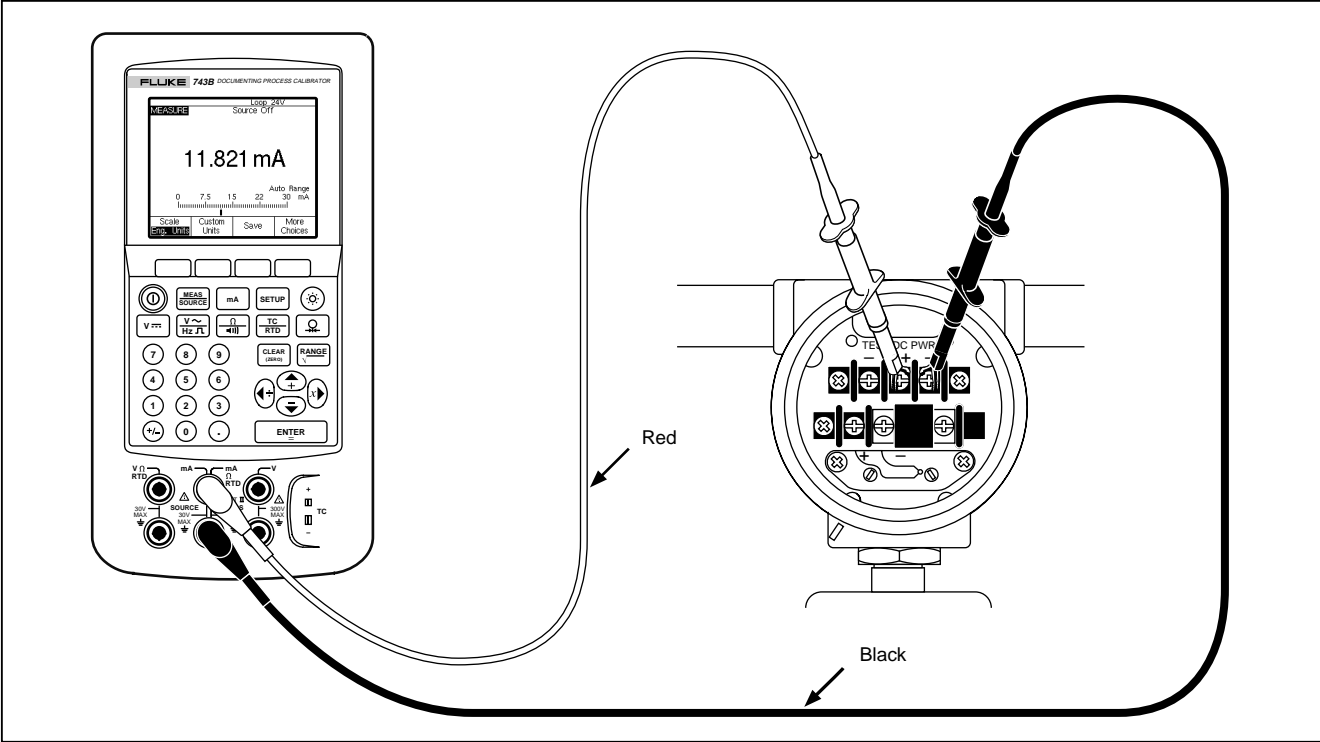

ki18c.eps

Figure 18. Connections for Supplying Loop Power

Sourcing Pressure

The calibrator provides a source pressure display function that requires the use of an external pressure hand pump. Use this function to calibrate instruments that require a pressure source or differential pressure measurement. See Figures 19 and 34 for information about that application.

Many ranges and types of pressure modules are available from Fluke. See “Accessories” near the back of this manual. Before you use a pressure module, read its Instruction Sheet. The modules vary in how you use them, how you zero them, what types of process pressure media are allowed, and accuracy specification.

To use the source pressure display, see Figure 19 and proceed as follows:

Warning







To avoid a violent release of pressure in a pressurized system, shut off the valve and slowly bleed off the pressure before you attach the pressure module to the pressure line.

Caution

To avoid mechanically damaging the pressure module, never apply more than 10 ft.-lb. of torque between the pressure module fittings or between the fittings and the body of the module. Always apply appropriate torque between the pressure module fitting and connecting fittings or adapters.

To avoid damaging the pressure module from overpressure, never apply pressure above the rated maximum printed on the pressure module.

To avoid damaging the pressure module from corrosion, use it only with specified materials. Refer to the printing on the pressure module or the pressure module instruction sheet for the acceptable material compatibility.

1. Connect a pressure module and pressure source to the calibrator as Figure 19 shows. The threads on the pressure modules accept ¼ NPT fittings. Use the supplied ¼ NPT to ¼ ISO adapter if necessary.
2. If necessary, press  for SOURCE mode.
3. Press . The calibrator automatically senses which pressure module is attached and sets its range accordingly.
4. Zero the pressure module as described in the module's Instruction Sheet. Modules vary in zeroing procedures depending on module type. You **MUST** perform this step before you execute a task that sources or measures pressure.
5. Pressurize the pressure line with the pressure source to the desired level as shown on the display.
6. If desired, you can change pressure display units to psi, mHg, inHg, mH₂O, inH₂O, inH₂O@60°F, ftH₂O, bar, g/cm², or Pa. Metric units (kPa, mmHg, etc.) are shown in Setup mode in their base units (Pa, mHg, etc.). Change the pressure display units as follows:
 - a. Press .
 - b. Press **Next Page** twice.
 - c. Press  with the cursor on **Pressure Units**.
 - d. Select the pressure units with the  or  keys.
 - e. Press .
 - f. Press the **Done** softkey.

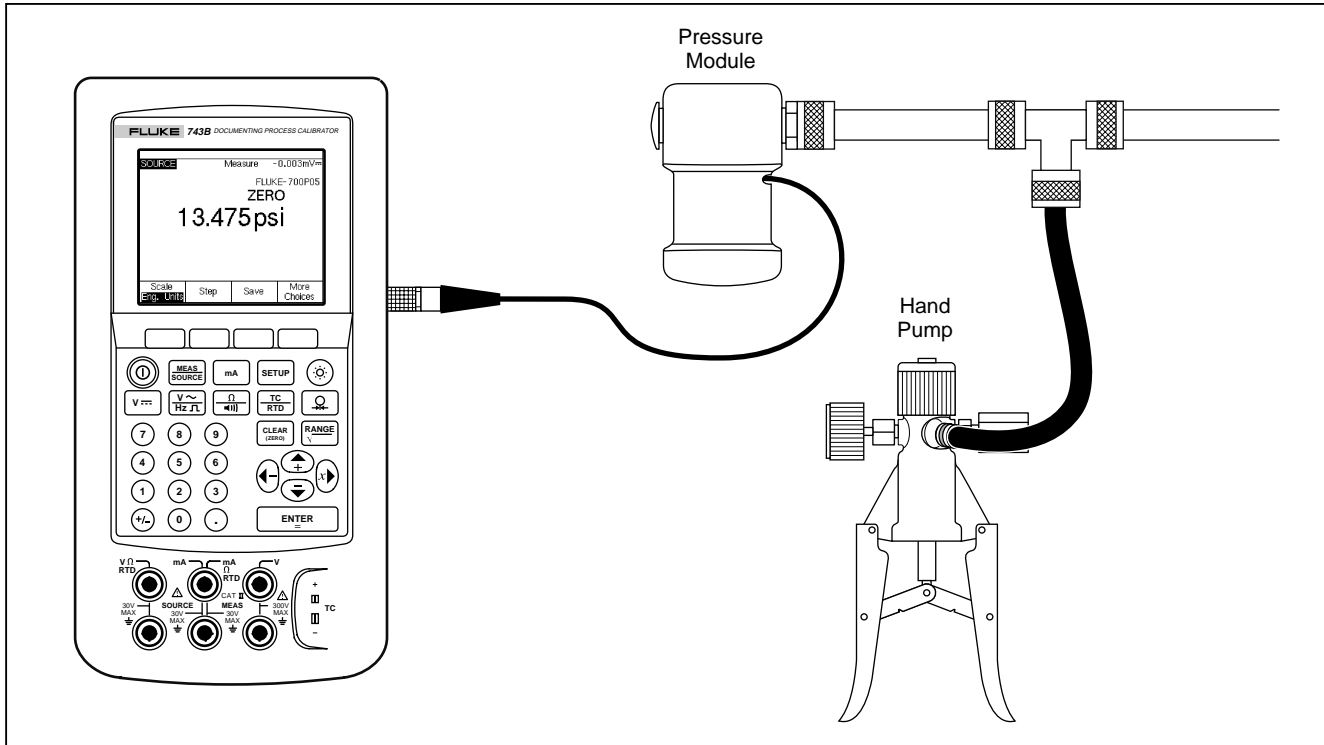

ki19c.eps

Figure 19. Connections for Sourcing Pressure

Simulating Thermocouples

Note

Refer to “Measuring Temperature” earlier in the manual for a table of data relating to thermocouple types supported by the calibrator.

Connect the calibrator TC input/output to the instrument under test with thermocouple wire and the appropriate thermocouple mini-connector (polarized thermocouple plug with flat, in-line blades spaced 7.9 mm [0.312 in] center to center). *One pin is wider than the other. Do not try to force a miniplug in the wrong polarization.* Figure 20 shows this connection. Proceed as follows to simulate a thermocouple:

1. Attach the thermocouple leads to the appropriate TC miniplug, then to the TC input/output as Figure 13 shows.
2. If necessary, press for SOURCE mode.
3. Press for the display that prompts you to enter thermocouple type.
4. Press the or key followed by to select the desired thermocouple type.

5. Press the or key followed by to select **Linear T** (default), or **Linear mV**, (for calibrating a temperature transmitter that responds linearly to millivolt inputs).
6. Enter the temperature you want to simulate as prompted by the display and press .

Note







*If you use copper wire instead of thermocouple wire, the reference junction is no longer inside the calibrator. The reference junction is moved to the instrument (transmitter, indicator, controller, etc.) input terminals. You must measure this external reference temperature accurately and enter it into the calibrator. Do this by pressing and setting **Ref. Junc. Compensat** and **Ref. Junc. Temp**. After you enter the external reference temperature, the calibrator corrects all voltages to compensate for this new reference junction temperature.*

Simulating RTDs

Note

Refer to Table 6 for information about RTD (Resistance-Temperature Detector) types supported by the calibrator.

Connect the calibrator to the instrument under test as shown in Figure 21. Proceed as follows to simulate an RTD (Resistance-Temperature Detector):

1. If necessary, press  for SOURCE mode.
2. Press  until the select RTD type display is showing.
3. Press the  or  keys followed by  to select the desired RTD type.
4. Enter the temperature you want to simulate as prompted by the display, then press .

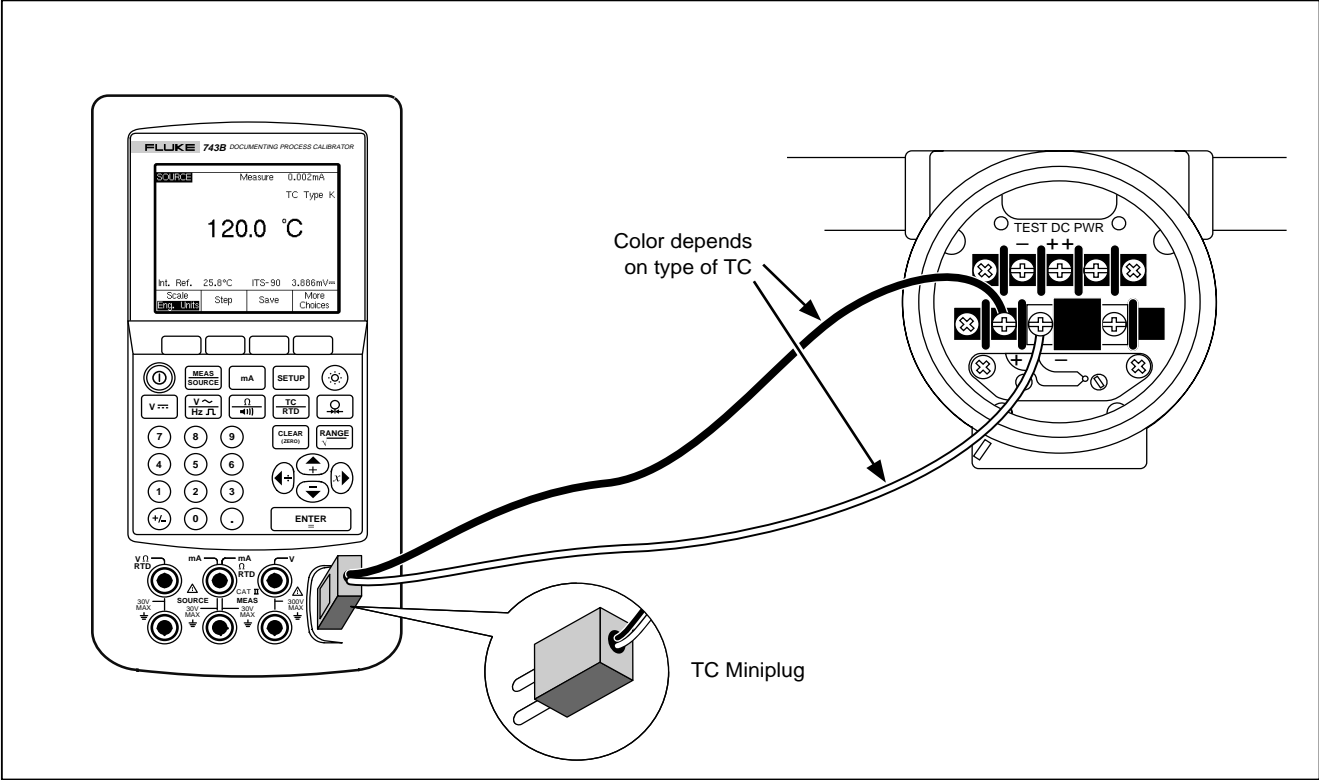
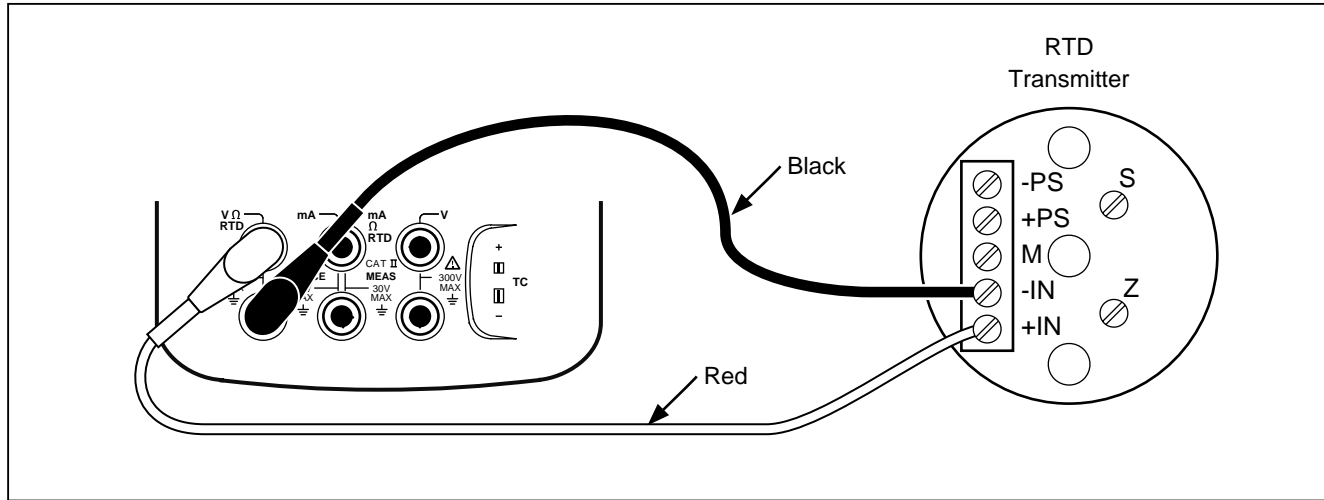

Figure 20. Connections for Simulating a Thermocouple

ki20c.eps









gj21f.eps

Figure 21. Connections for Simulating an RTD

Sourcing in Percent of Scale

This feature lets you scale the output in accordance with the input requirements of a particular process instrument's response. Percent of scale works for linear-responding transmitters, or square-root responding transmitters.









Linear-Responding Transmitters

1. If necessary, press  for SOURCE mode.
2. Select a source function (, , , , or ) as previously described and enter a value.
3. Press the **Scale** softkey.
4. Use the numeric keypad to enter the 0% of scale value (**0% Value**).
5. Press .
6. Use the numeric keypad to enter the 100% of scale value(**100% Value**).
7. Leave **Mode** set to %.
8. Press the **Done** softkey.

Percent of scale remains in effect until you press the **Scale** softkey again or you change the source function.

Square-Law Process Variables

When you select $\sqrt{\quad}$ within scaling, the calibrator output value is the percent value entered, squared, and converted to engineering units.



1. If necessary, press  for SOURCE mode.
2. Select a source function (, , , , or ) as previously described.
3. Press the **Scale** softkey.
4. Use the numeric keypad to enter the 0% of scale value (**0% Value**).
5. Press .
6. Use the numeric keypad to enter the 100% of scale value(**100% Value**).
7. Set **Mode** to $\sqrt{\quad}$.
8. Press .

9. Press the **Done** softkey.

Percent of scale remains in effect until you press the **Scale** softkey again.



Stepping and Ramping the Output Value

Two features are available for adjusting the value of source functions, except pressure, which requires that you use an external pressure source:

- Stepping the output manually with the  and  keys, or in automatic mode.
- Ramping the output with optional continuity or V trip detect.

Using Manual Step

The manual **Step** feature allows you to select a step size in engineering units (mV, V, mA, °C, etc.) or % of scale. Stepping the output in % of scale is useful for quickly jumping between 0% and 100% (set step size = 100%) or 0-50-100% (set step size = 50%). Stepping works in SOURCE and in MEASURE/SOURCE modes. Proceed as follows to select a step size:

1. Refer to the appropriate “Using Source Mode” subheading earlier in this manual (e.g., “Sourcing Electrical Parameters”) and connect the calibrator to the circuit to be tested.
2. If necessary, press  for SOURCE mode.
3. Set the calibrator for the desired source value.
4. If you want to step the source value in % of scale, set the % of scale value as described previously under “Sourcing in Percent of Scale.”
5. Press the **Step** softkey.
6. Use the numeric keypad to enter the step size in the units shown on the display.
7. Press the **Done** softkey.
8. Now you can adjust the output in steps by pressing the  and  keys.

Using Auto Step

To have the calibrator make a sequence of steps automatically, either once through the sequence or repetitively, proceed as follows:

1. Refer to the appropriate “Using Source Mode” subheading earlier in this manual (e.g., “Sourcing Electrical Parameters”) and connect the calibrator to the circuit to be tested.
2. If necessary, press  for SOURCE mode.
3. Set the calibrator for the desired source value.
4. If you want to step the source value in % of scale, set the % of scale value as described previously under “Sourcing in Percent of Scale.”
5. Press the **Step** softkey.
6. Press the **Auto Step** softkey.
7. Select values for the following parameters as you are prompted by the display:
 - Starting point (in units or % of scale)
 - Ending point
 - Number of steps
 - Time per step
 - Single shot or continuous repetition
 - Ramp pattern if continuous
 - Start delay
8. To start automatic stepping, press the **Start Step** softkey. The softkey label changes to **Stop Step**.
9. To stop automatic stepping, press the **Stop Step** softkey.
10. Press the **Done** softkey to resume normal operation.

Ramping the Output

Ramping sweeps the source up or down in value. Use the ramp feature to check a limit switch or alarm, or any time you want a smoothly increasing or decreasing output function. You can set the calibrator to ramp up or down in engineering units (mV, V, mA, °C, etc.) or % of scale.

During ramping, the output is adjusted 4 times per second. The size of the steps is determined by your choices of endpoints and ramp time. For example, if you set the calibrator to ramp from 1 mV to 1V over 10 seconds, the output is adjusted in approximately 25 mV steps.

Ramping continues until the selected limit is reached, or until an optional trip condition is encountered. The optional trip detect works as follows: during ramping, the calibrator checks for either a 1V change in dc voltage or a change in continuity status (**Open** or **Short**) from one ¼ second interval to the next.

Proceed as follows to ramp (i.e., sweep the source):

1. Refer to the appropriate heading earlier in this manual (e.g., “Sourcing Electrical Parameters”) and connect the calibrator to the circuit to be tested. Figure 22 shows an example.
2. To automatically stop ramping if a trip condition is detected, connect a voltage trip circuit to the V MEAS jacks or a continuity trip circuit to the mA Ω RTD MEAS jacks. (Continuity detection is not available when sourcing current.)
3. If necessary, press  for SOURCE mode.
4. Set the calibrator for the desired source value as previously described.
5. If you want to ramp the output in % of scale, set % of scale as described previously under “Sourcing in Percent of Scale.”
6. Press the **More Choices** softkey.

7. Press the **Ramp** softkey. The display changes to the following:

SOURCE RAMP			
Enter Start Value			
Start Value	????????	mA	
End Value	????????	mA	
Ramp Time	?????	seconds	
Trip Detect	Disabled		
Trip Function	V DC		
Abort			Done

gj41s.eps

8. Fill in the parameters as prompted. Enter the **Start Value**, **End Value**, and **Ramp Time**.
9. To automatically stop ramping if a trip condition is detected, set the **Trip Detect** to **Enabled**, and select **Voltage** or **Continuity** as the trip function.
10. Press the **Done** softkey. Note the **RAMP** annunciator next to **SOURCE** at the top of the display.
11. Select a low-to-high ramp or a high-to-low ramp with the **Ramp Up/Down** softkey.
12. To start ramping, press the **Start Ramp** softkey.
13. Ramping continues until a trip is detected (if enabled), the ramp time expires, or you press the **Stop Ramp** softkey.

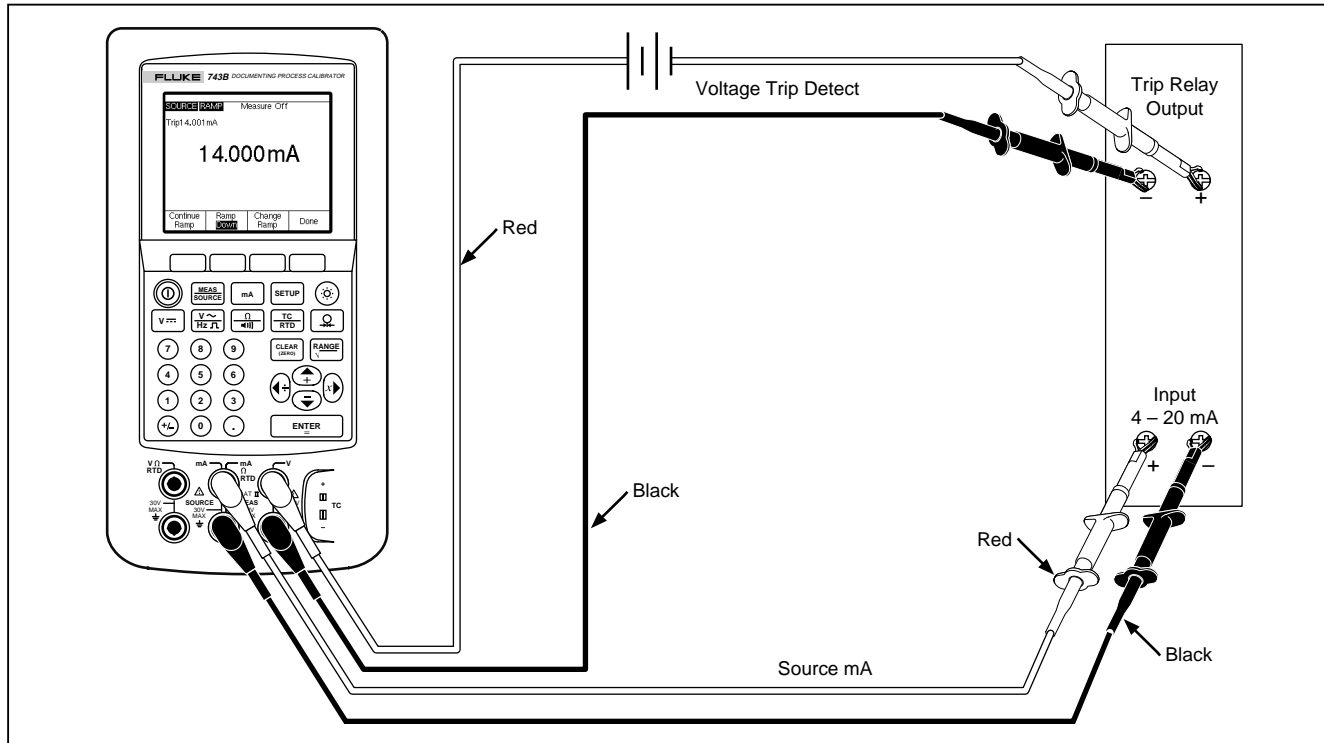

ki22c.eps

Figure 22. Checking a Relay Output Trip Alarm

Simultaneous Measure/Source

Use the MEASURE/SOURCE mode to calibrate or emulate a process instrument. Press  so that a split screen display appears as shown below.

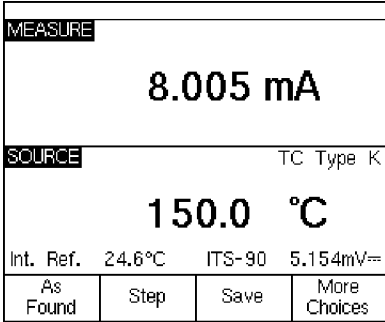

MEASURE			
8.005 mA			
SOURCE		TC Type K	
150.0 °C			
Int. Ref.	24.6°C	ITS-90	5.154mV=
As Found	Step	Save	More Choices

gj42s.eps

Table 7 shows the functions you can use simultaneously when Loop Power is disabled. Table 8 shows the functions you can use simultaneously when Loop Power is enabled.

You can use the **Step** or **Auto Step** features to adjust the output in MEASURE/SOURCE mode, or you can use the calibration routine provided when you press the **As Found** softkey.

The following two softkeys displayed in MEASURE/SOURCE mode are for use in calibrating a process instrument.

- **As Found**, which lets you set up a calibration routine to obtain and record as found data.
- **Auto Step**, which lets you set up the calibrator for auto-stepping, as previously described.

Instructions for calibrating a process instrument follow.

Table 7. Simultaneous MEASURE/SOURCE Functions with Loop Power Disabled

Measure Function	Source Function						
	dc V	mA	Freq	Ω	TC	RTD	Pressure
dc V	•	•	•	•	•	•	•
mA	•		•	•	•	•	•
ac V	•	•	•	•	•	•	•
Frequency (≥ 20 Hz)	•	•	•	•	•	•	•
Low Frequency (< 20 Hz)							
Ω	•		•	•	•	•	•
Continuity	•		•	•	•	•	•
TC	•	•	•	•		•	•
RTD	•		•	•	•	•	•
3W RTD	•		•	•	•	•	•
4W RTD	•		•	•	•	•	•
Pressure	•	•	•	•	•	•	

Table 8. Simultaneous MEASURE/SOURCE Functions with Loop Power Enabled

Measure Function	Source Function						
	dc V	mA	Freq	Ω	TC	RTD	Pressure
dc V	•		•	•	•	•	•
mA	•		•	•	•	•	•
ac V	•		•	•	•	•	•
Frequency (≥ 20 Hz)	•		•	•	•	•	•
TC	•		•	•		•	•
Pressure	•		•	•	•	•	

Calibrating a Process Instrument

When the calibrator is in simultaneous MEASURE/SOURCE mode, a built-in calibration routine is activated when you press the **As Found** softkey. (As Found data are the test results showing the condition of a transmitter before it is calibrated.) Additionally, the Model 743 runs tasks (procedures) that are developed using a host computer and compatible application software.









Caution

Calibration of pulsed or multiplexed RTD instruments with settling times of less than 100 ms may result in errors, and is not recommended.

Generating “As Found” Test Data

The following example shows how to generate *as found* data for a thermocouple temperature transmitter. The way you set up the template for the procedure is similar for Delta-P and 1 Pt. and 2 Pt. Switch tests.

In this case the calibrator is simulating the output of a thermocouple and measuring the resulting current from the transmitter. Other transmitters use this same method. Just go back to MEASUREMENT or SOURCE mode and change the operating parameters before you press **As Found**.

1. Connect the test leads to the instrument under test as shown in Figure 23. The connections simulate a thermocouple and measure the corresponding output current.
2. If necessary, press  for MEASURE mode.
3. Press .
4. Press  for SOURCE mode.
5. Press .
6. Use the  and  keys to select the thermocouple type, then press .
7. Enter a source value, for example 100 degrees, then .

8. Press **MEAS** for MEASURE/SOURCE mode. The display changes to:

MEASURE			
8.005 mA			
SOURCE		TC Type K	
150.0 °C			
Int. Ref.	24.6°C	ITS-90	5.154mV=
As Found	Step	Save	More Choices

gj42s.eps

9. Press the **As Found** softkey, followed by the **Instrument** softkey. The display changes to:

MEASURE			
0% Value		???????? mA	
100% Value		???????? mA	
Tolerance		???????? %	
Delay		?????? S	
SOURCE		TC Type K	
0% Value		???????? °C	
100% Value		???????? °C	
Test Strategy		3 ↑	
Abort	User Value	Custom Units	Done

gj44s.eps

10. Enter values for **0%** and **100%** of 4.0 mA and 20.0 mA, respectively. Set **Tolerance** to 0.5% of span. (Use other values if necessary for your application.)

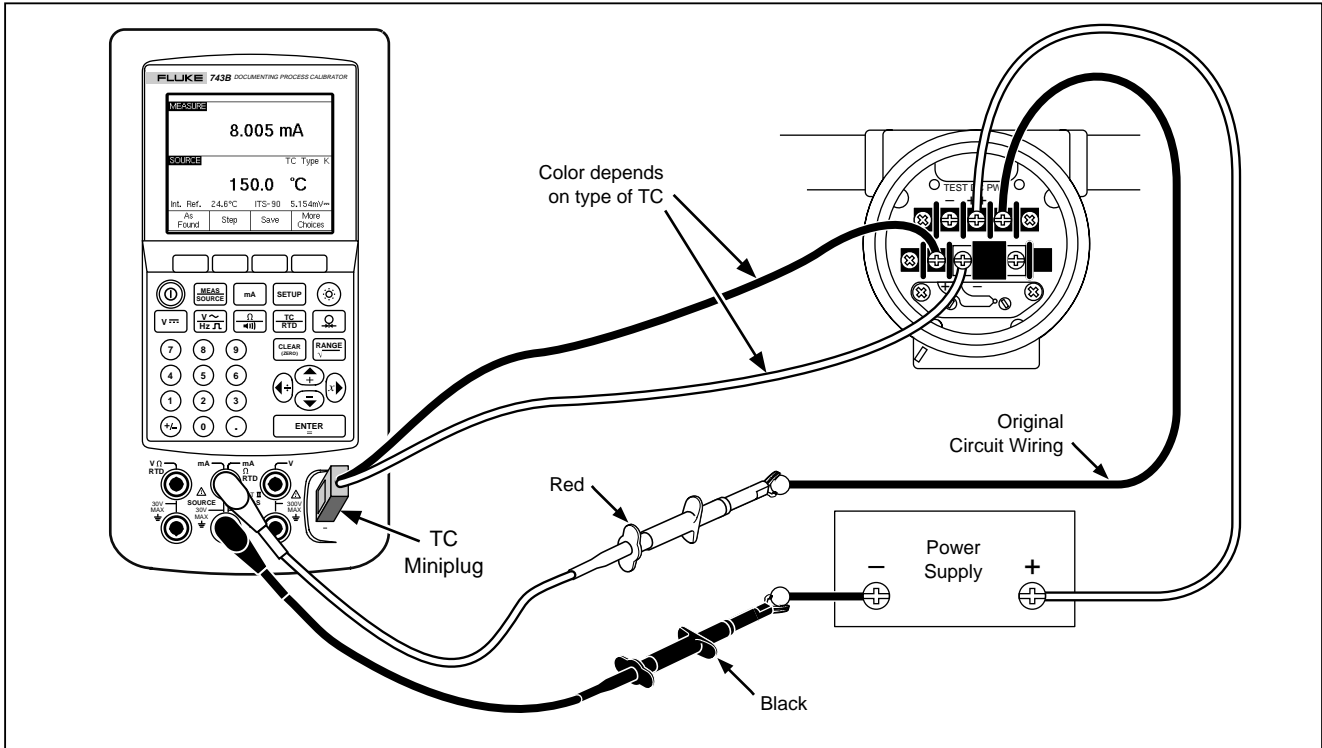

ki23c.eps

Figure 23. Calibrating a Thermocouple Temperature Transmitter

11. If the process instrument needs more time to settle than the calibrator's normal settling time (about 2 seconds) at each new stimulus level, enter that time in seconds for **Delay**.
12. Use the arrow keys to move the cursor down to enter **0%** and **100%** values for **SOURCE** temperature. Our example uses 100°C and 300°C.
13. If the instrument calibration procedure requires you to enter either the measurement value or source value by hand at each step, press the **User Value** softkey, for "user entered values."

Custom Units lets you define your own units such as "PH." See "Creating Custom Measurement Units," earlier in this manual for an example.

When you use custom units, the  symbol appears next to the value on the display and in results.

Press the **Done** softkey after you have programmed your custom unit.

14. The **Strategy** is the number of test points and which test points are performed rising and falling

in percent of scale. Our example uses five points (0%, 25%, 50%, 75%, and 100%), rising only. Rising is indicated by the up arrow on the display. Change to another test strategy by pressing  on this line. A list of strategies appears from which to choose. Select one, then press **Done**.

15. When you finish selecting the calibration parameters, the display appears as follows:

MEASURE			
0% Value	4.000 mA		
100% Value	20.000 mA		
Tolerance	0.50 %		
Delay	0 S		
SOURCE			
	TC Type	K	
0% Value	100.0 °C		
100% Value	300.0 °C		
Test Strategy	5 ↑		
Abort	User Value	Custom Units	Done

gj45s.eps

16. Press the **Done** softkey to accept the calibration parameters. The display changes to:

MEASURE			
4.011 mA			
SOURCE		TC Type K	
100.0 °C			
Int. Ref.	29.4°C	ITS-90	2.916mV
Abort	Auto Test	Manual Test	

gj46s.eps

17. You now have the choice of starting an automatic test or stepping through the test points manually. Press the **Auto Test** softkey to have the calibrator run through the tests automatically. (**Abort** gets you out of the calibration procedure.) The tests begin at the zero point, sourcing the correct temperature (a voltage) and measuring the corresponding current from the transmitter.

As soon as a measurement has settled and been captured, the calibrator moves to the next step. Because the calibrator waits for the

measurement to stop changing, the Auto Test works correctly for instruments with built-in damping. The error of the expected measured value is shown in the top left of the measure window.

18. The calibrator moves to the remaining set of points. For temperature and electrical parameter calibration, the points are done automatically. If you are sourcing pressure, the calibrator pauses at each step for you to adjust the pressure source. When the tests are complete, an error summary table such as the following is displayed.

SOURCE	MEASURE	ERROR %
100.0°C	3.904mA	-0.60
150.0°C	7.965mA	-0.22
200.0°C	12.053mA	0.33
250.0°C	16.094mA	0.59
300.0°C	20.175mA	1.09

Abort	Prev. Page	Next Page	Done
-------	------------	-----------	------

gj47s.eps

19. In the results summary test, failures are highlighted. An adjustment is required in this example because three tests show failures. The failures were outside the $\pm 0.5\%$ tolerance that we selected.
20. Either press the **Done** softkey to save the data, or the **Abort** softkey to delete the data and start over.

You can see the saved data entry and recall the table for later viewing through the **Review Memory** softkey during normal operation. With Model 743 you can upload this data to a host computer running compatible application software.

Adjusting the Transmitter

Proceed as follows to make the calibration adjustments to the transmitter. (Always refer to the transmitter manufacturer's instructions to locate the adjustment controls and connection points for your transmitter.)

1. Press the **Done** softkey while viewing the results summary.
2. Press the **Adjust** softkey. The calibrator sources 0% of span (100°C in this example) and displays the following softkeys:
 - **Go to 100%/Go to 0%**
 - **Go to 50%**
 - **As Left**
 - **Exit Cal**
3. Adjust the transmitter output for 4 mA then press the Go to 100% softkey.

4. Adjust the transmitter output for 20 mA.
5. If the span was adjusted in step 4, you must go back and repeat steps 3 and 4 until no more adjustment is required.
6. Now check the transmitter at 50%. If it is within specification, your adjustment is complete. If not, adjust the linearity and begin this procedure again at step 3.

“As Left” Test Run

Proceed as follows to generate and record *as left* data for the thermocouple temperature transmitter you have just adjusted.

1. Press the **As Left** softkey to record *as left* data.
2. Press the **Auto Test** softkey to begin an automatic sequence through all the test points, or you can step through the tests manually.
3. When the tests are complete, observe the error summary table, such as the following.

SOURCE	MEASURE	ERROR %
100.0°C	3.966 mA	-0.21
150.0°C	7.991 mA	-0.05
200.0°C	12.029 mA	0.18
250.0°C	*16.023 mA	0.14
300.0°C	19.963 mA	-0.10

Abort	Prev. Page	Next Page	Done
-------	------------	-----------	------

gj48s.eps

An asterisk (*) next to a measure or source value indicates an unsettled value ( annunciator) when the measurement was taken.

4. If all the results are within specification, as they are this time, press the **Done** softkey. An entry in memory is made for *as left* data.

Test Comments

Model 743B runs tasks (custom procedures) that are developed using a host computer and compatible application software. A task may display a list of proposed comments during execution. When the comment list is displayed, select a comment to be saved with the test results by pressing the \uparrow and \downarrow keys followed by .

Calibrating a Delta-Pressure Flow Instrument

The procedure to calibrate a $\sqrt{\quad}$ instrument is the same as for other instruments, as just described, with the following differences:

- Source square-root is automatically enabled after the **As Found** calibration template is complete.

- Measure/Source displays are in engineering units.
- The measurement percentage is automatically corrected for the transmitter's square-root response, and is used to compute instrument errors.

You select the $\sqrt{\quad}$ instrument procedure in a menu after you press the **As Found** softkey.

Calibrating a Limit Switch

The procedure to calibrate a limit switch also uses the As Found and As Left calibration templates. Select either the **1 Pt. Switch** or **2 Pt. Switch** procedure in a menu after you press the **As Found** softkey. Figure 24 defines the terminology used in calibrating limit switches.

The template to set up the limit switch procedure lets you select the following parameters:



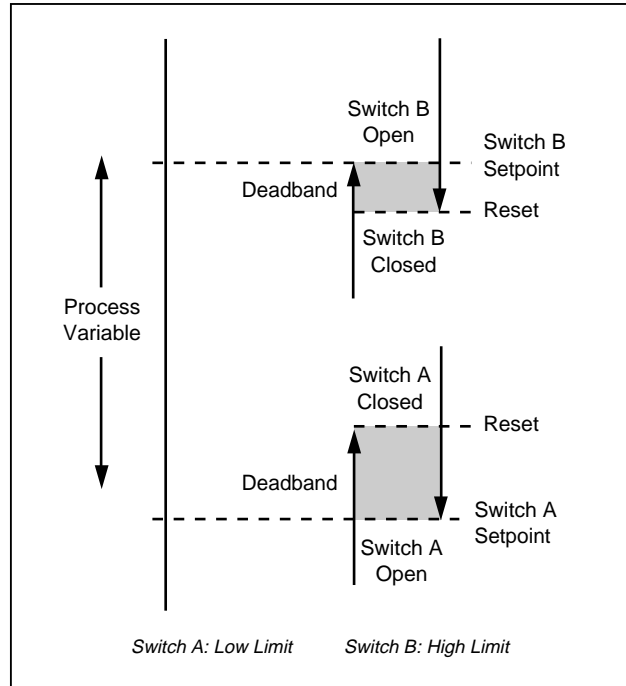





- Switch sense (normally open or closed).
- For each setpoint:
 - Setpoint value.
 - Setpoint tolerance.
 - High limit or low limit.
 - Minimum deadband.
 - Maximum deadband.



gj24f.eps

Figure 24. Limit Switch Terminology

The procedure for testing a pressure limit switch follows. The switch in this example sets at a high limit of 10 psi. The set state is a closed switch contact. For pressure switches, you use the **Manual Test** choice. For testing switches that do not require sourcing pressure, you can use the **Auto Test** choice.

1. Connect the test leads between the pressure switch contact output and the mA Ω RTD (middle) jacks on the calibrator.
2. Connect the pressure module to the calibrator, and connect a pressure line to the limit switch. Leave the pressure line vented to atmosphere.
3. If necessary, press  for MEASURE mode.
4. Press   for the continuity measure function.
5. Press  for SOURCE mode.
6. Press  for the pressure source function.
7. Press  to zero the pressure module.
8. Press .
9. Press the **As Found** softkey.
10. Highlight **1 Pt. Switch Test** from the menu and press .
11. Press  to modify the parameters for Setpoint 1.
12. Make the following selections:
Setpoint 1 = 10.000 psi
Setpoint Type = High
Set State = Short
13. Press the **Done** softkey.
14. Set the **Tolerance** to 0.5 psi.
15. The next parameters, **Deadband Min** and **Deadband Max**, are optional. Do not set them in this example.

16. Set **Trip Function** to **Trip Cont** by cycling through the choices with the  key.
17. Press the **Done** softkey.
18. Press the **Manual Test** softkey.
19. Close the pressure line vent and slowly bring the pressure up to the trip point.
20. When the switch sets, slowly bring the pressure back down until the switch resets. You can repeat this cycle as many times as you want.
21. Press the **Done** softkey and view the results.
22. Press the **Done** softkey and if desired, enter **Tag**, **S/N**, and/or **ID**.
23. Press the **Done** softkey.
24. Now press the **Adjust** softkey if you want to adjust the limit switch and test it again.
25. Use the softkeys to control the calibrator, and adjust the limit switch as necessary.

26. Press the **Done** softkey.
27. Press the **As Left** softkey to run the test again with the same parameters. Results from the As Found and As Left tests are saved in the calibrator memory for later viewing, or in the case of the 743B, uploading.

The procedure for limit switches that respond to other parameters work similarly. When you do a 2 Pt. Limit Switch Test, you simply follow the prompts on the display for testing the first switch, changing test leads, and testing the second limit switch.

Transmitter Mode

You can set up the calibrator so that a varying input (MEASURE) controls the output (SOURCE), like a transmitter. This is called “Transmitter mode.” In Transmitter mode, the calibrator can be temporarily used as a substitute for a defective or suspect transmitter.

Warning





Do not use Transmitter mode in any environment that requires intrinsic safe equipment and practices.

Caution

Transmitter mode is for diagnostic purposes only. Use a fresh battery. Do not use the calibrator in place of a transmitter for extended periods.

To set up the calibrator to emulate a transmitter, proceed as follows:

1. Disconnect the control bus wires from the transmitter output (loop current or dc V control signal).
2. Connect test leads from the appropriate calibrator SOURCE jacks to the control wires in place of the transmitter.
3. Disconnect the process input (e.g., thermocouple) from the transmitter.
4. Connect the process input to the appropriate calibrator MEASURE jacks or input connector.
5. If necessary, press  for MEASURE mode.
6. Press the appropriate function key for the process input.

7. Press  for SOURCE mode.
8. Press the appropriate function key for the control output (e.g.,  or ). If the transmitter is connected to a current loop that has a power supply, select **Simulate Transmitter** for the current output choice.
9. Select a source value, e.g., 4 mA.
10. Press  for MEASURE/SOURCE mode.
11. Press **More Choices** until the **Transmitter Mode** softkey appears.
12. Press the **Transmitter Mode** softkey.
13. Set the 0% and 100% values for MEASURE and SOURCE on the display. You can select **Linear** or $\sqrt{\quad}$ for the transfer function.
14. Press **Done**.
15. The calibrator is now in Transmitter mode. It is measuring the process input and sourcing the control signal output proportional to the input.
16. To change any of the Transmitter mode parameters, press **Change Setup**, and repeat the process in step 13.
17. To exit Transmitter mode, press the **Abort** softkey.

Memory Operations

Saving Results

As Found/As Left test results are automatically saved at the end of each test routine. Any other time during MEASURE, SOURCE, or MEASURE / SOURCE you can press the **Save** softkey to save the data on the display for later review.

After you press **Save**, the calibrator saves the information on the display and shows a saved result index number, the date and time, and the percentage of memory available, as in the following display:

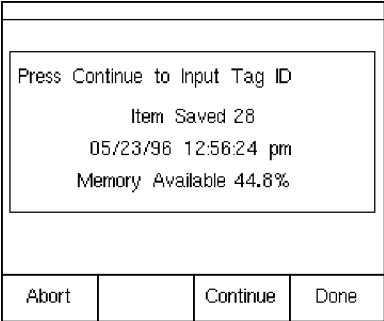

gj49s.eps

If you want to add information to the saved data, the calibrator has a way for you to do so. If you press the **Continue** softkey, the display prompts you to enter the instrument tag identifier (**Tag**), instrument serial number (**S/N**), and operator name (**ID**), as shown in the following display:

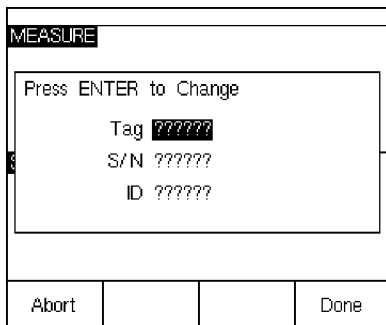

gj50s.eps

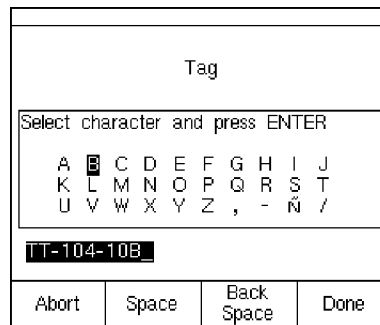

gj51s.eps

Enter alphanumeric characters into the highlighted field with the optional bar code wand (743 only) or the calibrator keys.

To enter alphanumeric characters using the calibrator keys, press with the cursor on the field you would like to change (for example, Tag, above). The display presents you with an alphanumeric entry window as follows:

1. Enter numbers using the numeric keypad, and letters by highlighting the desired character with the , , , and keys followed by . Enter a space character by pressing the **Space** softkey, followed by .
2. When the entry showing at the bottom of the window is what you want, press the **Done** softkey.

Reviewing Memory

Press the **More Choices** softkey until **Review Memory** appears, then press the **Review Memory** softkey to recall and view saved results.

When you press the **Review Memory** softkey, the display changes to:

Results From 05/23/96 1 of 20			
Measure	04:36:47 pm		
Source	04:36:59 pm		
TT-101-14A	04:39:26 pm		
Measure Source	04:39:53 pm		
Measure	04:40:20 pm		
PT-121-5	04:41:37 pm		
Logged Data	04:44:10 pm		
Min Max	04:44:25 pm		
Min Max	04:44:30 pm		
Measure	04:44:54 pm		
Go To Result	Prev. Page	Next Page	Done

gj52s.eps

Press **↑** or **↓** and **ENTER** or the **Go to Result** softkey to view a saved result.







Data Logging (Model 743B Only)

With Model 743B only, you can record a series of measurements for later uploading to a host computer running compatible application software. You can log up to 8000 readings, depending on the reading rate, duration, and how much memory is being used for other things such as tasks or saved results. You enter the reading rate and duration in minutes as shown next.

MEASURE LOG			
Press ENTER to Change			
Reading Rate	20 /min		
Duration	10 minutes		
Number of Points	200		
Memory Available	28.5%		
Abort			Done

gj53s.eps

Proceed as follows to log data:

1. If necessary, press  for MEASURE mode.
2. Press the **More Choices** softkey.
3. Press the **Log** softkey.
4. A list appears from which you select a reading rate (1, 2, 5, 10, 20, 30, or 60 readings per minute). Use the  or  key to select the reading rate.
5. Press .
6. Press  to move the cursor to **Duration**.
7. Use the numeric keypad to enter the duration in minutes, followed by . The maximum duration will depend on the reading rate and how much memory is available to log data. The table below gives an estimate of the limits for duration, assuming that no memory is being used for other purposes.

Readings/Minute	Maximum Readings	Approximate Duration
1	8000	133 hours
2	8000	66 hours
5	8000	26 hours
10	8000	13 hours
20	8000	6 hours
30	7980	4 hours
60	7980	2 hours

Caution

A long logging duration can exceed the life of a battery charge. Use a fresh battery and the appropriate duration, or use the optional battery eliminator to avoid losing power during a logging session. If  appears during a log session, the session is terminated and data collected to that point is saved.

8. After you enter your choice of duration, you can see how much memory that duration would consume. See the **Memory Used** and **Memory Remaining** percentage figures on the display. **Memory Used** indicates the percentage of available memory that will be used by the specified log. **Memory Remaining** indicates the percentage of memory that will remain unused after logging is complete.
9. Press the **Done** softkey. The display changes to:
10. Note the **LOG** annunciator next to **MEASURE**. Press the **Start Logging** softkey to start taking data.
11. The calibrator will continue storing data points until the duration has elapsed, or until you press the **Done** softkey. Either way of terminating logging causes the calibrator to save the data as a memory item that can be uploaded to a host computer running compatible application software.

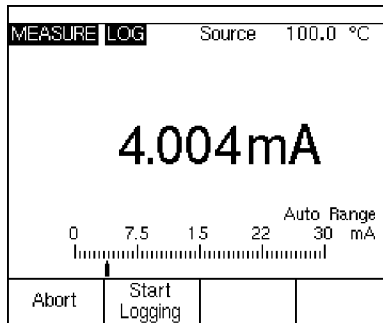

gj54s.eps

Recording Min and Max Measurements

You can set the display to record and show the maximum and minimum readings. Min and Max readings are always undamped, even if Dampen is On. Press the **More Choices** softkey twice, then press the **Min Max** softkey to turn on this feature. Press the  key to reset the Min Max registers. Press the **Min Max** softkey again to revert to the normal display. The following figure shows the display with Min Max on:

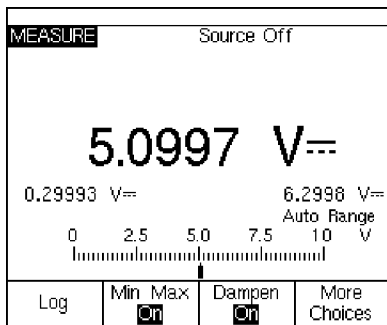

gj55s.eps

Running a Preloaded Task (743B only)

Press the **More Choices** softkey until the **Tasks** softkey appear, then press **Tasks** to view the list of tasks (procedures) downloaded from a host computer. Tasks are 743B calibrator configurations, saved with a procedure name, for example the type and manufacturer of a specific transmitter. A task configures the calibrator for transmitter calibration with all the calibration parameters (source and measure functions, 0% and 100% levels, test strategy) predefined.

While the task is controlling the calibrator, the **Continue** softkey becomes **Continue Task**.

Clearing Memory

In Setup mode, highlight the **Clear Memory** choice and press  to clear all the memory:





- Saved results
- Min Max data
- Log data sets (Model 743 only)

A confirmation message appears so that you do not inadvertently erase the memory.

Using the Built-in Calculator

For solving mathematical equations that involve the calibrator's source or measured value, you can use the calibrator's built-in calculator. The present measure and source values, including units, are always available to be inserted into an equation at a single keystroke. The calibrator keeps measuring and sourcing during calculator operation.

Start the calculator from the **SOURCE**, **MEASURE**, or **MEASURE/SOURCE** mode by pressing the **Calc** softkey. You may have to press **More Choices** to get the **Calc** softkey.

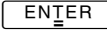
After you press **Calc**, the display, number keys, and keys with calculator functions (, , , , , and ) become an algebraic-entry calculator.

Press **Done** when you want to resume normal calibrator operation.

Saving to and Recalling from the Registers

When the calibrator is in calculator mode, the top half of the display shows three register names and their contents:

- **MEASURE** (the present measured value)
- **SOURCE** (the present sourced value)
- **REGISTER** (temporary storage for your use)

Insert the contents of any register into a calculation by pressing the **Recall** softkey followed by the softkey for the desired register.

Press **Store** to copy the number from the calculator display (lower half) into **REGISTER** to temporarily save the number for later use, or into **SOURCE**.

Using the Calculator to Set the Source Value

When you store to **SOURCE**, the calibrator presents you with a choice of unit multipliers when appropriate (e.g., mV or V), then starts sourcing that value. The calibrator ignores attempts to store out-of-range values to **SOURCE**.

Quick Guide to Applications

The following figures show test lead connections and which calibrator function to use for many different applications.

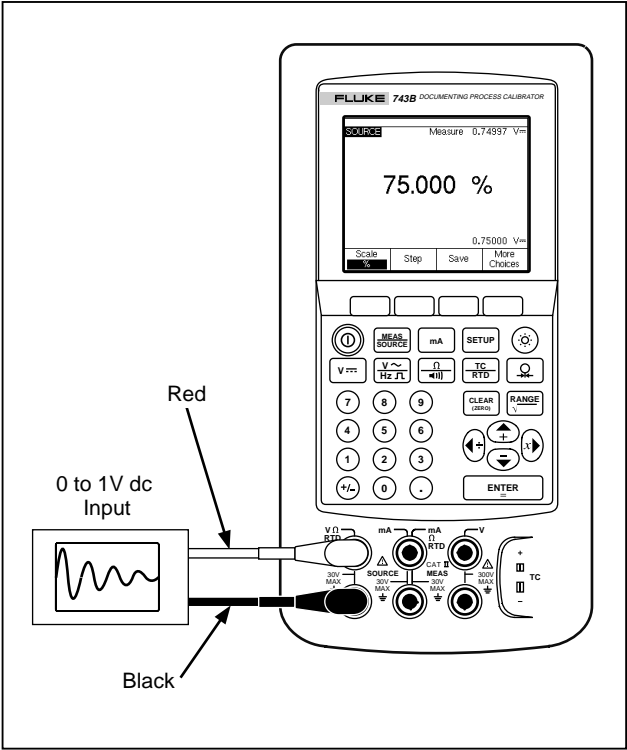

Figure 25. Calibrating a Chart Recorder

ki25c.eps

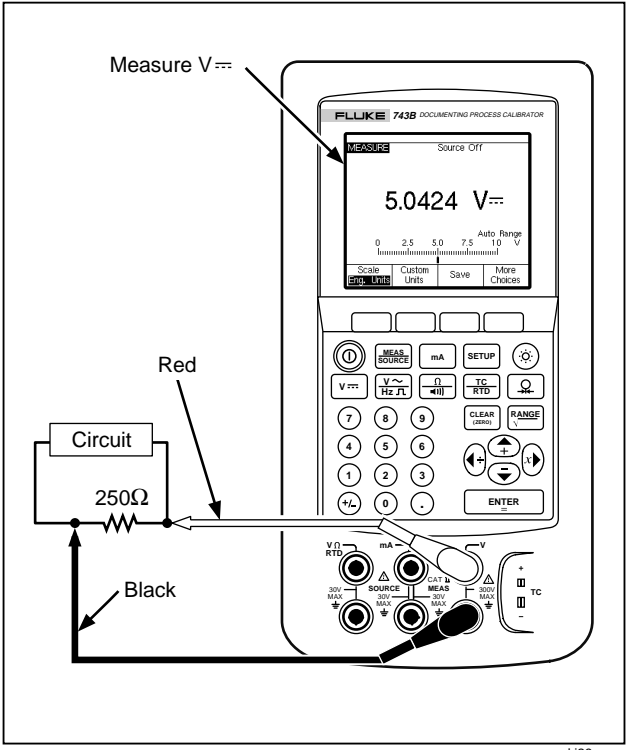
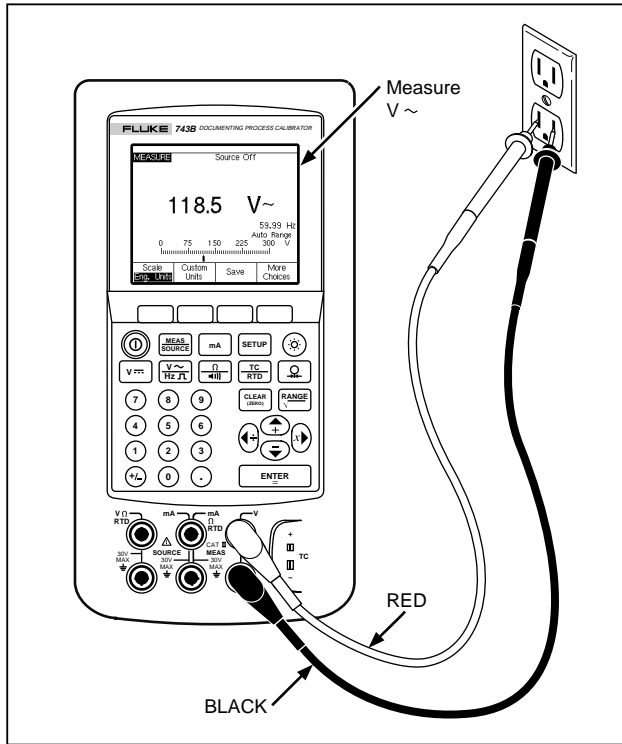

Figure 26. Measuring Voltage Drop

ki26c.eps



ki27c.eps

Figure 27. Monitoring AC Line Voltage and Frequency

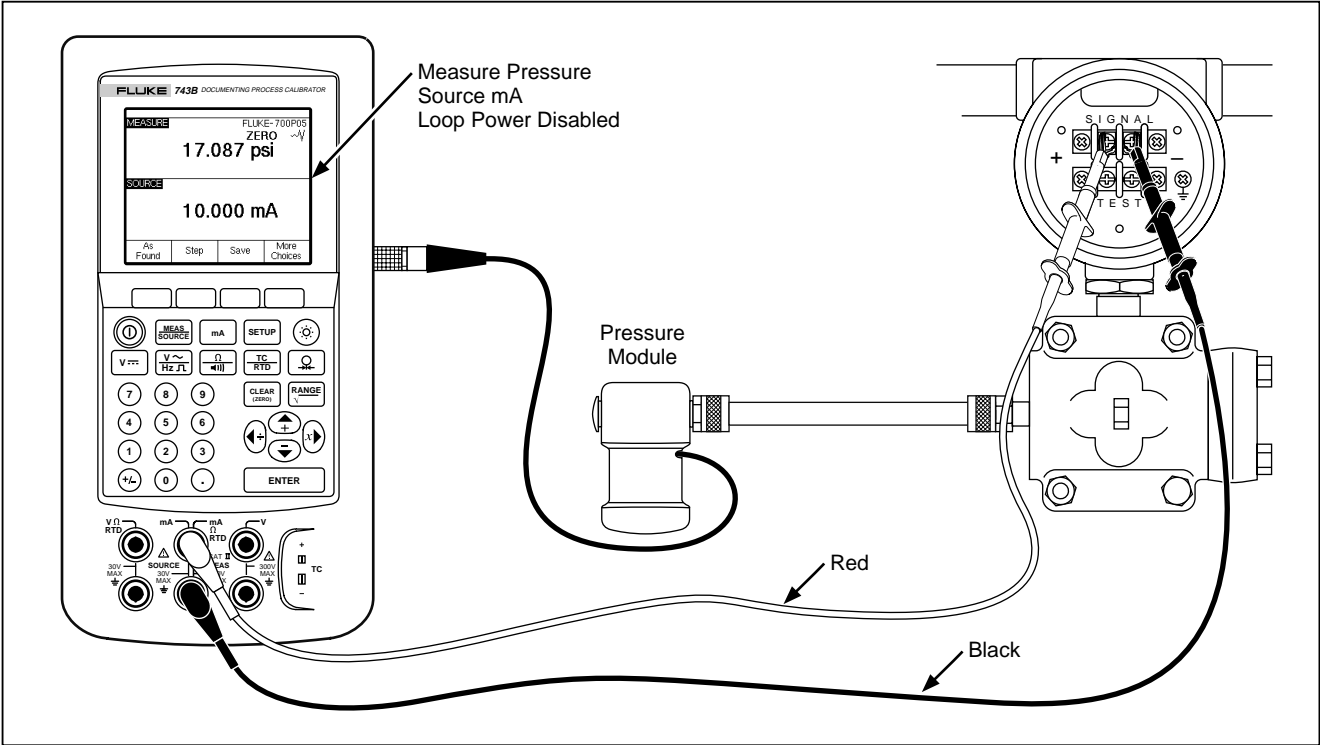

ki28c.eps

Figure 28. Calibrating a Current-to-Pressure (I/P) Transmitter

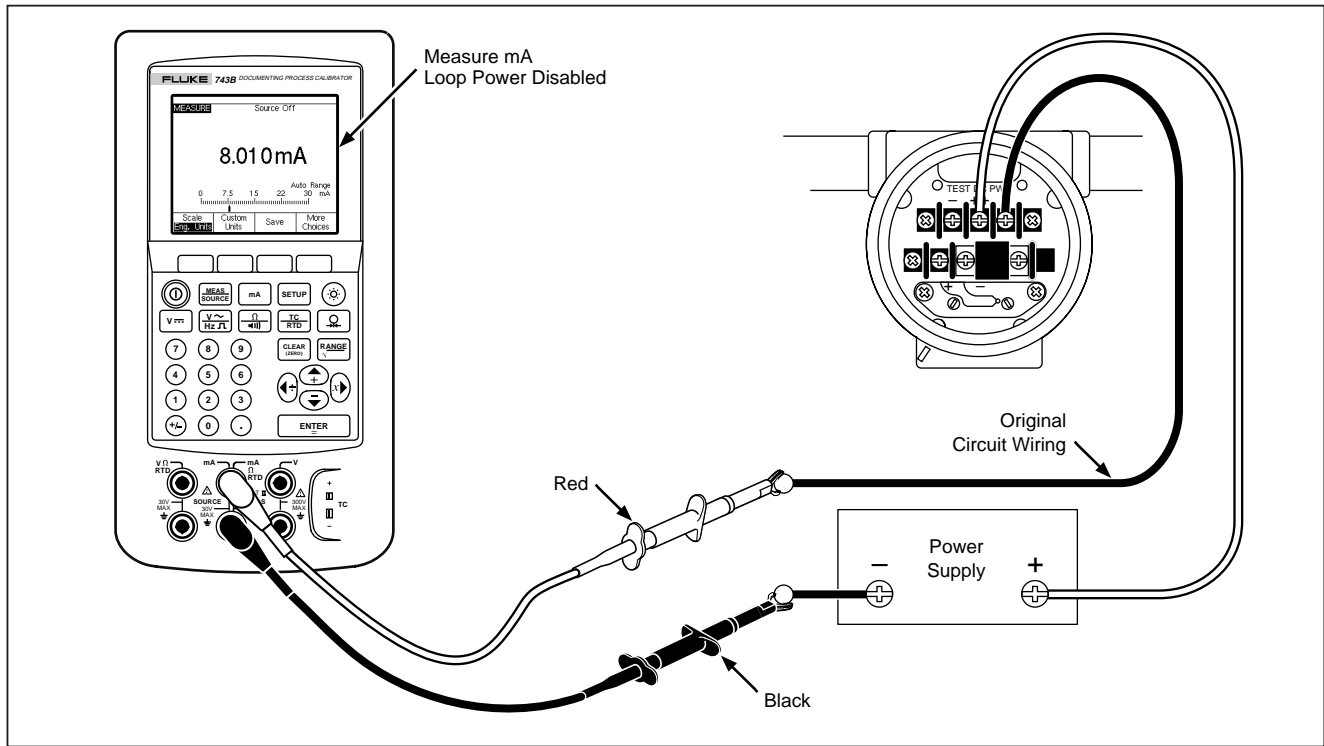

ki29c.eps

Figure 29. Measuring the Output Current of a Transmitter

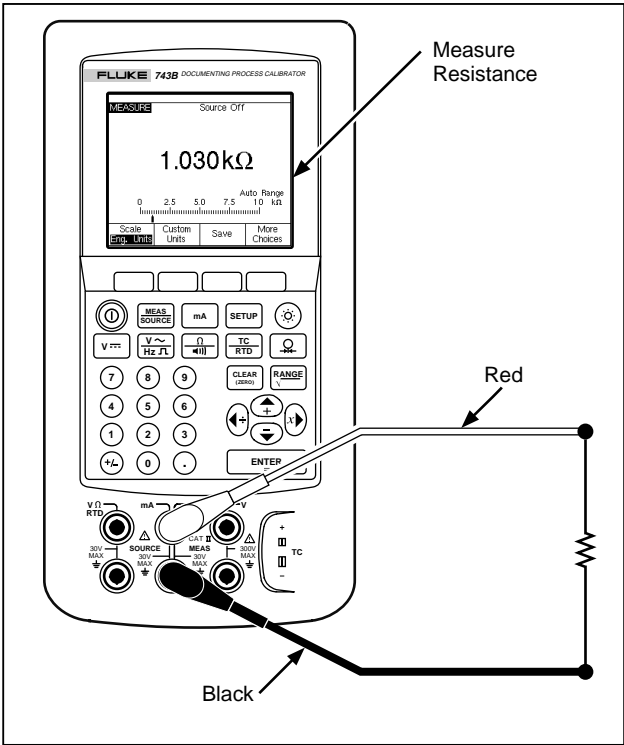

ki30c.eps

Figure 30. Measuring a Precision Resistor

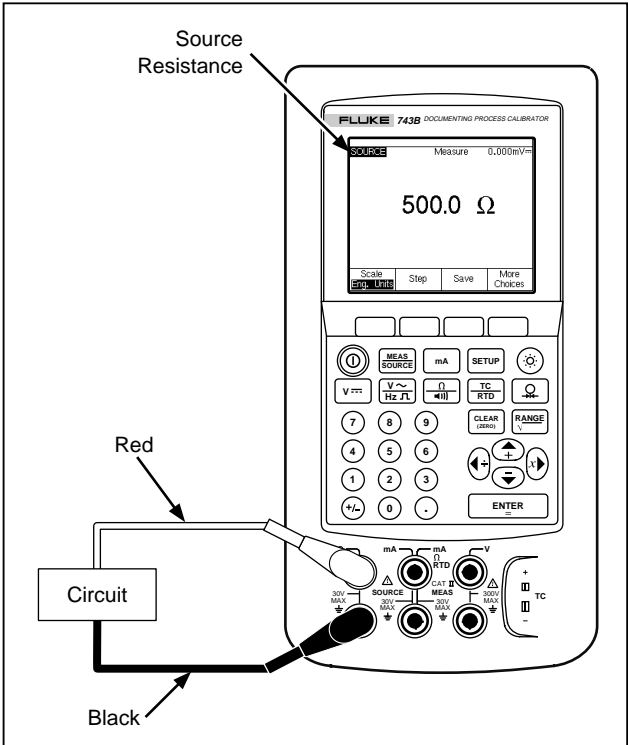

ki31c.eps

Figure 31. Sourcing Resistance

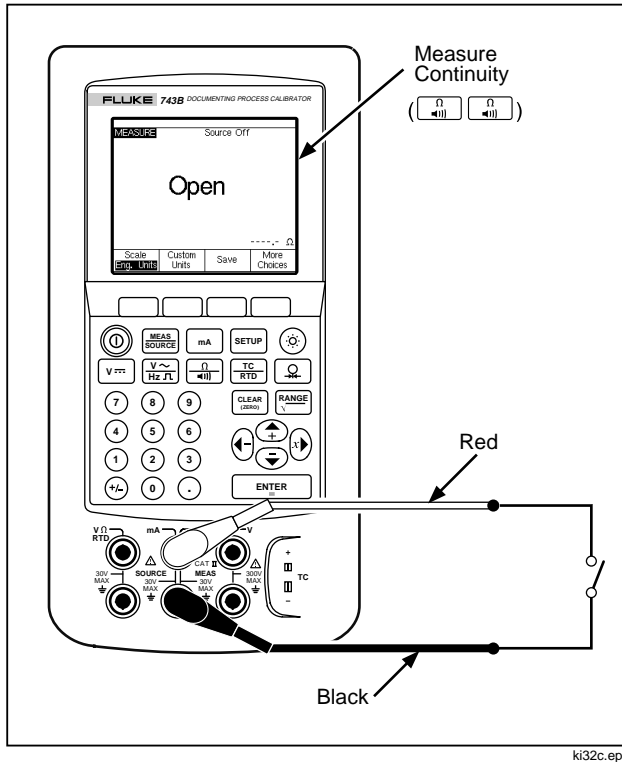

Figure 32. Checking a Switch

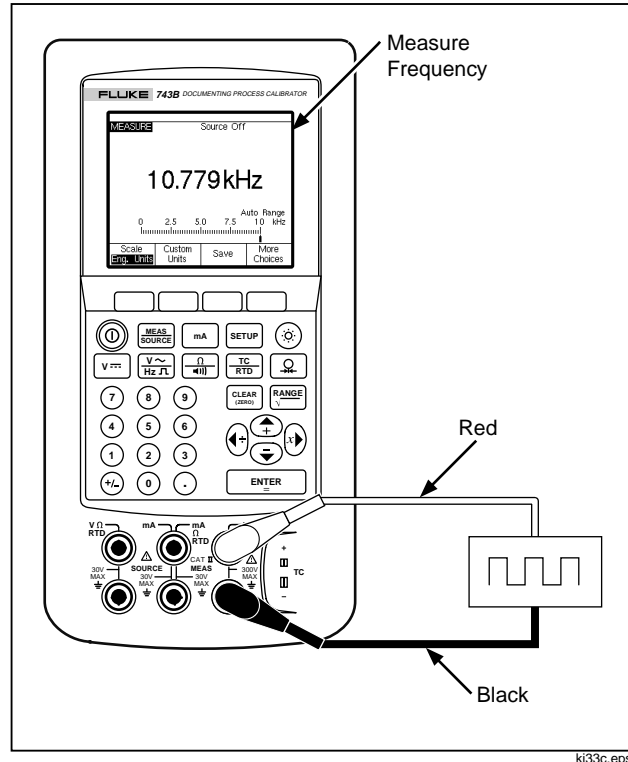
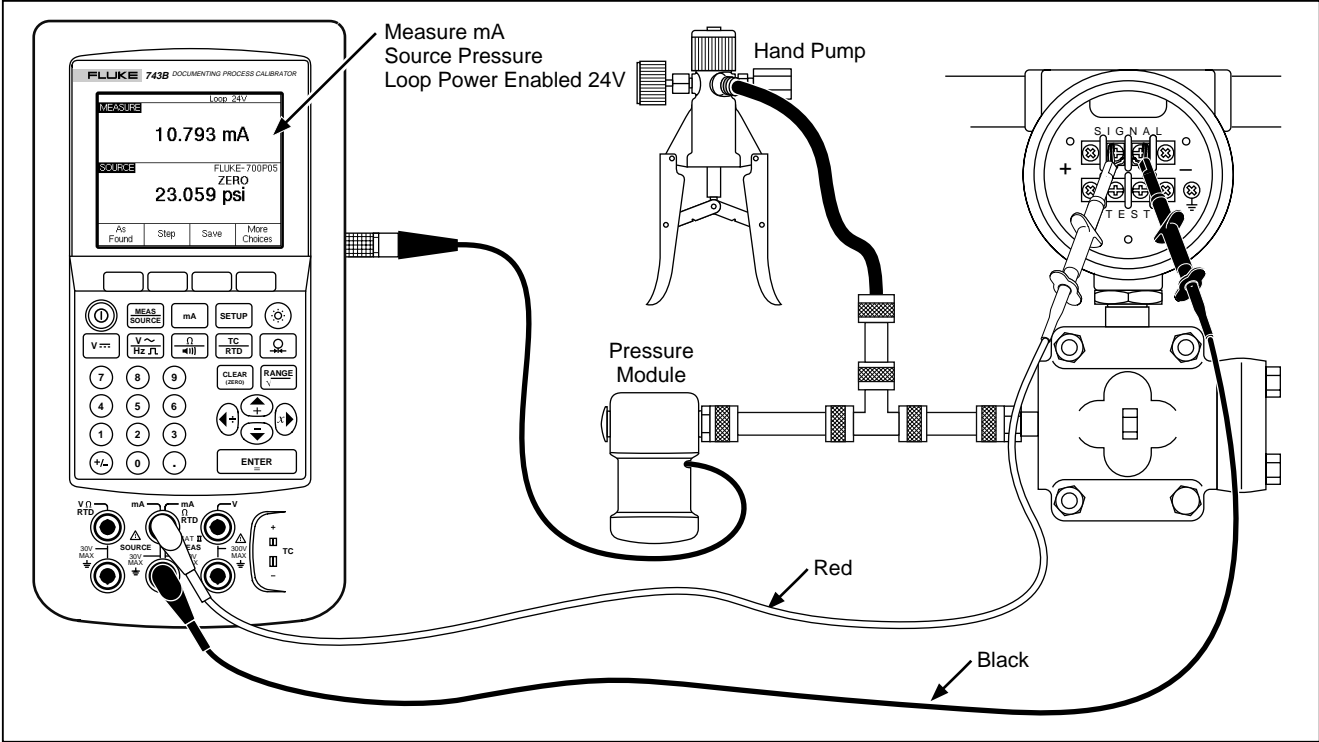
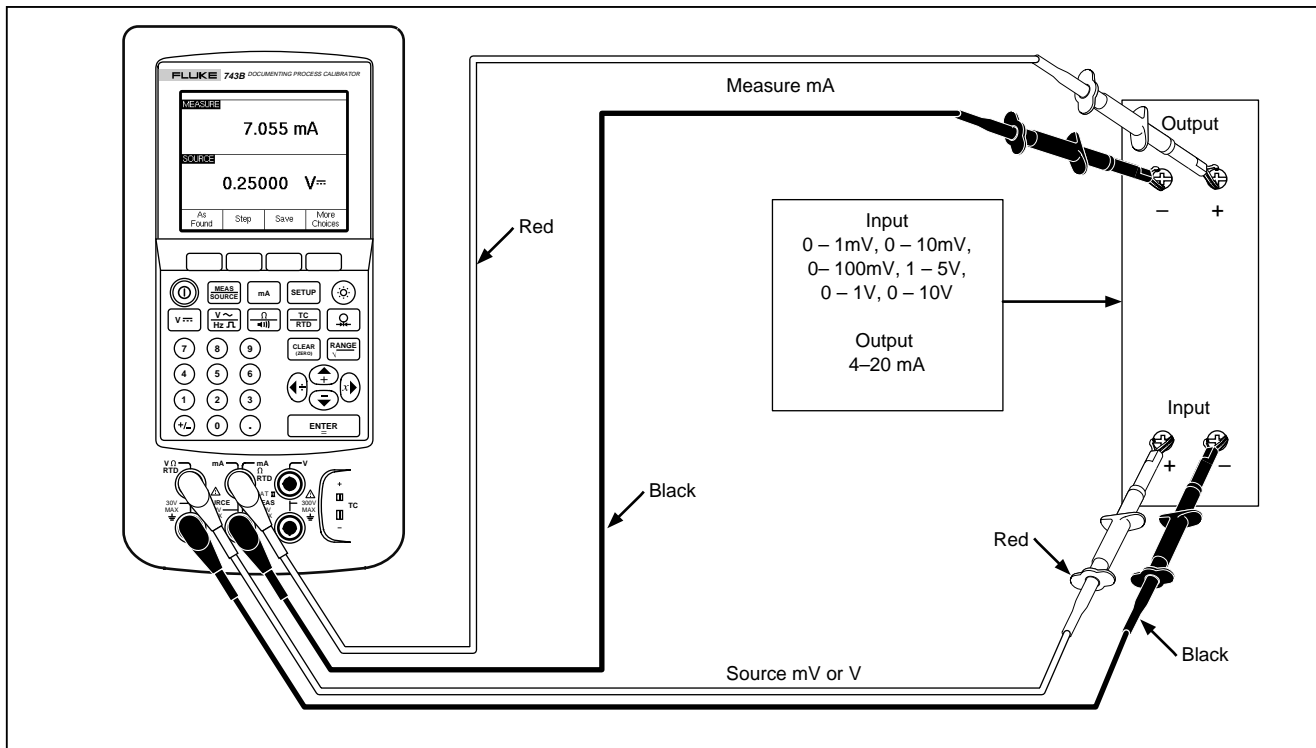

Figure 33. Checking a Tachometer



ki34c.eps

Figure 34. Calibrating a Pressure-to-Current (P/I) Transmitter



ki35c.eps

Figure 35. Calibrating a mV to Current Transmitter

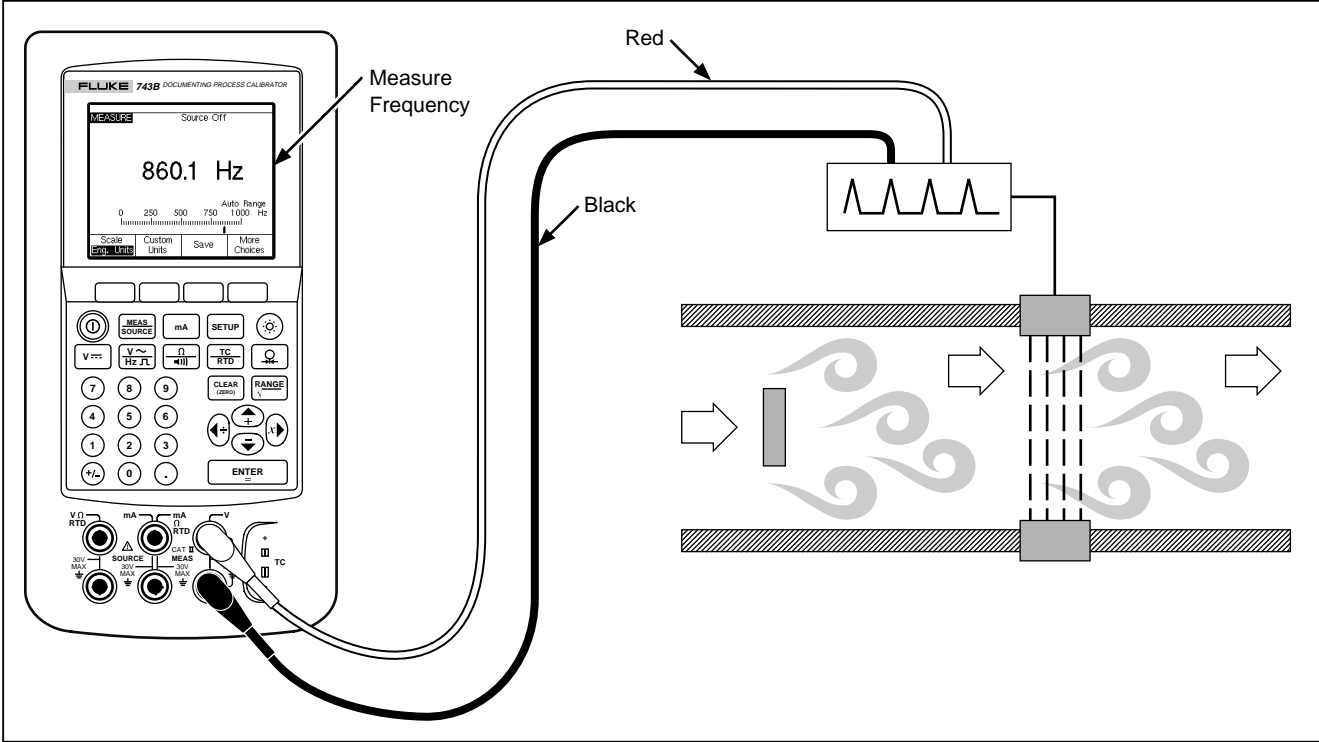

ki36c.eps

Figure 36. Checking a Vortex Shedding Flowmeter

Communicating with a PC (Model 743 Only)

You can upload and download procedures and saved results to a PC. An IBM PC™-compatible personal computer, Microsoft Windows, and Fluke *DPC/TRACK*™ software, or a qualified Fluke partner's software are required. A custom serial interface cable for the 743B is included with *DPC/TRACK*. Refer to the *DPC/TRACK Users Manual* for further instructions.

Maintenance

Note

Additional maintenance instructions, including a calibration procedure and a list of replaceable parts is available in the 74X Series Calibration Manual (PN 602505).

Replacing the Battery Pack

Replace the battery pack when it no longer holds a charge for the rated interval. The battery normally lasts for up to 1000 charge/discharge cycles. To order a replacement battery, order Model BP7217 Nickel-Cadmium Battery Pack. In the USA and Canada call Fluke Service Parts at 1-800-526-4731. Outside the USA and Canada call +1 425-356-5500.

Note



Do not mix spent Nickel-Cadmium batteries with the solid waste stream. Spent batteries should be disposed of by a qualified recycler or hazardous materials handler. Contact your authorized Fluke Service Center for recycling information.

Internal Lithium Backup Battery

A lithium battery maintains the memory contents and Setup settings. The normal service life for the lithium battery is 3 to 5 years.

You cannot access the lithium battery. Return the calibrator to an authorized Fluke service center if you need to replace the lithium battery. When the lithium battery is 3 years old, replace it at the next calibration interval as a preventive maintenance procedure.

Cleaning the Calibrator

Clean the calibrator and pressure modules with a soft cloth dampened with water or water and mild soap.

Caution



To avoid damaging the plastic lens and case, do not use solvents or abrasive cleansers.

Calibration Data

The date the calibrator was last calibrated shows on the calibration sticker and on the last screen in Setup mode. The CAL. STATUS number on the sticker should always match the Calibration Status number in the calibration SETUP screen. Calibration of the 741B and 743B is to be done by qualified personnel. Refer to the *74X Series Calibration Manual* (PN 602505).

In Case of Difficulty

If the calibrator operates abnormally, do not use it. Protection may be impaired. When in doubt, have the calibrator serviced.

If the display is blank or unreadable, but the beeper works when you turn the calibrator on, make sure the contrast is not maladjusted. Press the  and  keys to adjust the contrast.

If the calibrator will not turn on, check for a dead battery or unplugged battery eliminator. If the calibrator is receiving power, the display flashes when you turn it on. To see if the calibrator is receiving power, cup your hands around the display to shield it from ambient light, and watch the display as you press the **ⓘ** button. If there is a flash, but the calibrator does not power up normally, have the calibrator serviced.

Service Center Calibration or Repair

Calibration, repairs, or servicing not covered in this manual should be performed only by qualified service personnel. If the calibrator fails, check the nickel-cadmium battery pack first, and replace it if needed.

Verify that the calibrator is being operated in accordance with the instructions in this manual. If the calibrator is faulty, send a description of the failure with the calibrator. Pressure modules do not need to accompany the calibrator unless the module is faulty also. Be sure to pack the calibrator securely, using the original shipping container if it is available. Send the equipment postage paid and insured, to the

nearest Service Center. Fluke assumes no responsibility for damage in transit.

A Fluke 741B or 743B calibrator covered by the warranty will be promptly repaired or replaced (at Fluke's option) and returned to you at no charge. See the back of the title page for warranty terms. If the warranty period has expired, the calibrator will be repaired and returned for a fixed fee. If the calibrator or pressure module is not covered under the warranty terms, contact an authorized service center for a price quote for repair.

To locate an authorized service center, call Fluke using any of the phone numbers listed below, or visit us on the World Wide Web: www.fluke.com

USA and Canada: 1-800-44-FLUKE
(1-800-443-5853)

Europe: +31 402-678-200

Japan: +81-3-3434-0181

Singapore: +65-★-276-6196

Anywhere in the world: +1-425-356-5500

Replacement Parts

Table 9 lists the Fluke part number of each user-replaceable part for Models 741B and 743B. See

“Standard Equipment,” near the front of this manual, and “Accessories,” later in this manual for model or part numbers of standard and optional equipment.

Table 9. Replacement Parts

Item	Fluke Part Number
Adjustable Quick-Release Strap	946769
Rubber Side Plug	938274
Battery Door	938357
Bail	938340
Bail Screw	943431
Case Screw	942797
Lens for Model 741B	949487
Lens for Model 743B	949490
Input/Output Jack Decal	946756
BC7210 Battery Charger Instruction Sheet (multilingual)	944020
<i>Note: Refer to “Standard Equipment” and “Accessories” for model or part numbers for most replaceable equipment.</i>	

Accessories

The Fluke accessories listed below are compatible with the 741B and 743B calibrators. For more information about these accessories and their prices, contact your Fluke representative.

- Fluke-700SW DPC/TRACK application software for Microsoft Windows. DPC/TRACK provides everything you need to interface the 743B with a PC-compatible computer. With DPC/TRACK, you can compose and load tasks (procedures), unload results, generate reports, and create an instrument calibration database.
- Fluke-700BCW Bar Code Wand
- Fluke-700-IV Current Shunt, for simultaneous dc current sourcing and measuring.
- Pressure Modules, Fluke model numbers listed below. (Differential models also operate in gage mode.) Contact your Fluke representative about new pressure modules not listed here.
 - Fluke-700P01: 0 to 10" H₂O (differential, dry)
 - Fluke-700P02: 0 to 1 psi (differential, dry)
 - Fluke-700P22: 0 to 1 psi (differential, wet)
 - Fluke-700P03: 0 to 5 psi (differential, dry)
 - Fluke-700P23: 0 to 5 psi (differential, wet)
 - Fluke-700P04: 0 to 15 psi (differential, dry)
 - Fluke-700P24: 0 to 15 psi (differential, wet)
 - Fluke-700P05: 0 to 30 psi (gage, wet)
 - Fluke-700P06: 0 to 100 psi (gage, wet)
 - Fluke-700P07: 0 to 500 psi (gage, wet)
 - Fluke-700P08: 0 to 1,000 psi (gage, wet)
 - Fluke-700P09: 0 to 1,500 psi (gage, wet)
 - Fluke-700P29: 0 to 3,000 psi (gage, wet)
 - Fluke-700P30: 0 to 5,000 psi (gage, wet)
 - Fluke-700P31: 0 to 10,000 psi (gage, wet)

Fluke-700PA3: 0 to 5 psi (absolute, wet)
Fluke-700PA4: 0 to 15 psi (absolute, wet)
Fluke-700PA5: 0 to 30 psi (absolute, wet)
Fluke-700PA6: 0 to 100 psi (absolute, wet)

Fluke-700PV3: 0 to -5 psi (vacuum, dry)
Fluke-700PV4: 0 to -15 psi (vacuum, dry)

Fluke-700PD2: ± 1 psi (dual range, dry)
Fluke-700PD3: ± 5 psi (dual range, dry)
Fluke-700PD4: ± 15 psi (dual range, dry)
Fluke-700PD5: $-15/+30$ psi (dual range, wet)
Fluke-700PD6: $-15/+100$ psi (dual range, wet)
Fluke-700PD7: $-15/+200$ psi (dual range, wet)

- Fluke-700PCK Pressure Module Calibration Kit (requires pressure calibration equipment and a PC compatible computer)
- Fluke-700TC1 TC miniplug kit
- Fluke-700TC2 TC miniplug kit

- C781 Soft Carrying Case
- C789 Soft Carrying Case
- C700 Hard Carrying Case
- BE9005 Series Battery Eliminator for bench-top use
- BP7217 Ni-Cd Battery Pack
- *74X Series Calibration Manual* (PN 602505)
- TL series test leads
- AC series test lead clips
- TP series test lead probes
- 80C series mini thermocouple connectors
- 80T-IR Infrared Temperature Probe, -18°C to 260°C
- PV350 Pressure/Vacuum Module

- 80T-150U Temperature Probe
- 80PK series thermocouples
- 80i-410 Clamp-on DC/AC Current Probe
- 80i-1010 Clamp-on DC/AC Current Probe
- 80i-500s Clamp-on AC Current Probe (requires the Y9108 adapter)
- 80i-1000s Clamp-on AC Current Probe (requires the Y9108 adapter)
- 80i-kW Current and Power Probe

Specifications

All specifications apply from +18°C to +28°C unless stated otherwise.

All specifications assume a 5 minute warmup period.

Measurement specifications are valid only when Damping is turned on. When damping is turned off, or when the  annunciator is displayed, floor specifications are multiplied by 3. Floor specifications are the second part of the specifications, usually expressed as "% of full scale." The measure pressure, temperature, and frequency functions are specified only with damping on.

The standard specification intervals for the 741B and 743B are 1 and 2 years. Typical 90-day source and measurement accuracy can be estimated by dividing the 1 year "% of Reading" or "% of Output" specifications by 2. Floor specifications, expressed as "% of f.s.", remain constant.

To achieve the best noise rejection, use battery power and tie all three common jacks together.

DC Voltage Measurement

Range	Resolution	Models 741B and 743B % of Reading +% of Full Scale	
		1 Year	2 Year
110 mV	1 μ V	0.025% + 0.015%	0.05% + 0.015%
1.1V	10 μ V	0.025% + 0.005%	0.05% + 0.005%
11V	100 μ V	0.025% + 0.005%	0.05% + 0.005%
110V	1 mV	0.05% + 0.005%	0.1% + 0.005%
300V	10 mV	0.05% + 0.005%	0.1% + 0.005%
<p>Temperature Coefficient: (0.001% of rdg. + 0.0015% f.s.)/°C in the ranges -10 to 18°C and 28 to 50°C</p> <p>Input Impedance: 5 MΩ</p> <p>Common Mode Error: 0.008% f.s./(Common Mode Volt)</p> <p>Maximum Input Voltage: 300V rms</p>			

AC Voltage Measurement

Frequency Range	Models 741B and 743B % of Reading + Number of Counts	
	1 Year	2 Year
20 Hz to 40 Hz	2% + 10	2% + 10
40 Hz to 500 Hz	0.5% + 5	0.5% + 5
500 Hz to 1 kHz	2% + 10	2% + 10
1 kHz to 5 kHz	10% + 20	10% + 20
<p>Ranges : 1.1000V, 11.000V, 110.00V, 300.0V rms Resolution: 11.000 counts in all ranges except 300V; 3,000 counts on 300V range. Input Impedance: 5 MΩ and <100 pF Temperature Coefficient: 10% of specification/$^{\circ}$C in the ranges -10 to 18$^{\circ}$C and 28 to 50$^{\circ}$C Input Coupling: ac Maximum Input Voltage: 300 V rms Minimum Input Voltage: 0.5V above 1 kHz</p>		
<p><i>Specifications apply for 10% to 100% of voltage range.</i></p>		

DC Current Measurement

Range	Resolution	Models 741B and 743B % of Reading +% of Full Scale	
		1 Year	2 Year
30 mA	1 μ A	0.01% + 0.015%	0.02% + 0.015%
110 mA	10 μ A	0.01% + 0.015%	0.02% + 0.015%
Temperature Coefficient: (0.001% of rdg. + 0.002% f.s.)/ $^{\circ}$ C in the ranges -10 to 18 $^{\circ}$ C and 28 to 50 $^{\circ}$ C Common Mode Error: 0.01% f.s./(Common Mode Volt) Maximum Input Voltage: 30V dc			

Resistance Measurement

Range	Resolution	Models 741B and 743B % of Reading + ohms	
		1 Year	2 Year
11 Ω	0.001 Ω	0.05% + 0.05	0.075% + 0.05
110 Ω	0.01 Ω	0.05% + 0.05	0.075% + 0.05
1.1 k Ω	0.1 Ω	0.05% + 0.5	0.075% + 0.5
11 k Ω	1 Ω	0.1% + 10	0.1% + 10
Temperature Coefficient: (0.01% f.s. + 2 m Ω)/ $^{\circ}$ C in the ranges -10 to 18 $^{\circ}$ C and 28 to 50 $^{\circ}$ C Common Mode Error: 0.005% f.s./(Common Mode Volt) Maximum Input Voltage: 30V dc			

Continuity Testing

Tone	Resistance
Continuous tone	<25 Ω
May or may not get tone	25 to 400 Ω
No tone	>400 Ω

Frequency Measurement

Ranges	Accuracy	
	1 Year	2 Year
1.00 Hz to 109.99 Hz	0.05 Hz	0.05 Hz
110.0 Hz to 1099.9 Hz	0.5 Hz	0.5 Hz
1.100 kHz to 10.999 kHz	0.005 kHz	0.005 kHz
11.00 kHz to 50.00 kHz	0.05 kHz	0.05 kHz

Minimum Amplitude for Frequency Measurement (square wave):

<1 kHz: 300 mV p-p

1 kHz to 30 kHz: 1.4 V p-p

>30 kHz: 2.8V p-p

Maximum input:

<1 kHz: 300V rms

>1 kHz: 30V rms

Input Impedance: 5 M Ω

For frequency measurement less than 109.99 Hz, specifications apply for signals with a slew rate greater than 5 volt/millisecond.

DC Voltage Output

Range	Resolution	Models 741B and 743B % of Output + % of Full Scale	
		1 Year	2 Year
110 mV	1 μ V	0.01% + 0.005%	0.015% + 0.005%
1.1 V	10 μ V	0.01% + 0.005%	0.015% + 0.005%
15 V	100 μ V	0.01% + 0.005%	0.015% + 0.005%

Temperature Coefficient: (0.001% of output + 0.001% of f.s.)/°C in the ranges -10 to 18°C and 28 to 50°C
Maximum Output Current: 10 mA
Loading: (0.001% f.s. + 1 μ V)/ mA
Common Mode Error: 0.008% f.s./(Common Mode Volt)
Maximum Input Voltage: 30V dc

DC Current Output

Range/Mode	Resolution	Models 741B and 743B % of Output + % of Full Scale	
		1 Year	2 Year
22 mA/ Source mA	1 μ A	0.01% + 0.015%	0.02% + 0.015%
22 mA/ Simulate Transmitter (Current Sink)	1 μ A	0.02% + 0.03%	0.02% + 0.03%
<p>Maximum Burden Voltage: 24V</p> <p>Temperature Coefficient: (0.003% of output + 0.003% of f.s.)/°C in the ranges -10 to 18°C and 28 to 50°C</p> <p>Common Mode Error: 0.008% f.s./(Common Mode Volt)</p> <p>Maximum Input Voltage: 30V dc</p>			
<p><i>Specification applies for currents between 2 mA and 22 mA. For current below 2 mA, typical accuracy is 0.15% of full scale.</i></p>			

Resistance Sourcing

Range	Resolution	Models 741B and 743B % of Output + ohms	
		1 Year	2 Year
11.000Ω	1 mΩ	0.01% + 0.02	0.02% + 0.02
110.00Ω	10 mΩ	0.01% + 0.04	0.02% + 0.04
1.1000 kΩ	100 mΩ	0.02% + 0.5	0.03% + 0.5
11.000 kΩ	1Ω	0.03% + 5	0.04% + 5

Temperature Coefficient: (0.01% of f.s.)/°C in the ranges -10 to 18°C and 28 to 50°C

Maximum and Minimum Current through Source Resistance:

- 11Ω Range:** 3 mA dc max, 0.1 mA dc min
- 110Ω Range:** 3 mA dc max, 0.1 mA dc min
- 1.1 kΩ Range:** 3 mA dc max, 0.01 mA dc min
- 11 kΩ Range:** 1 mA dc max, 0.01 mA dc min

Common Mode Error: 0.008% f.s./(Common Mode Volt)

Maximum Input Voltage: 30V dc

Frequency Sourcing

Range	Accuracy
	1 and 2 Year
0.00 Hz to 10.99 Hz	0.01 Hz
11.00 Hz to 109.99 Hz	0.1 Hz
110.0 Hz to 1099.9 Hz	0.1 Hz
1.100 kHz to 21.999 kHz	0.002 kHz
22.000 kHz to 50.000 kHz	0.005 kHz

Waveform Choices: Zero-symmetric sine or positive square wave, 50% duty cycle.
Amplitude: 0.1 to 10V pk
Amplitude Accuracy:
 0 Hz to 1099 Hz: 3% of output + 0.5% f.s
 1.1 kHz to 10.9 kHz: 10% of output + 0.5% f.s
 11 kHz to 50 kHz: 30% of output + 0.5% f.s
Maximum Input Voltage: 30V dc

Temperature, Thermocouples

Temperature, TCs, Models 741B and 743B					
Type	Range °C	Measure °C		Source °C	
		1 Year	2 Year	1 Year	2 Year
E	-250 to -200	1.3	2.0	0.6	0.9
	-200 to -100	0.5	0.8	0.3	0.4
	-200 to -100	0.5	0.8	0.3	0.4
	600 to 1000	0.4	0.6	0.2	0.3
N	-200 to -100	1.0	1.5	0.6	0.9
	-100 to 900	0.5	0.8	0.5	0.8
	900 to 1300	0.6	0.9	0.3	0.4
J	-210 to -100	0.6	0.9	0.3	0.4
	-100 to 800	0.3	0.4	0.2	0.3
	800 to 1200	0.5	0.8	0.2	0.3
K	-200 to -100	0.7	1.0	0.4	0.6
	-100 to 400	0.3	0.4	0.3	0.4
	400 to 1200	0.5	0.8	0.3	0.4
	1200 to 1372	0.7	1.0	0.3	0.4
T	-250 to -200	1.7	2.5	0.9	1.4
	-200 to 0	0.6	0.9	0.4	0.6
	0 to 400	0.3	0.4	0.3	0.4

Temperature, Thermocouples (cont.)

Type	Range °C	Measure °C		Source °C	
		1 Year	2 Year	1 Year	2 Year
B	600 to 800	1.3	2.0	1.0	1.5
	800 to 1000	1.0	1.5	0.8	1.2
	1000 to 1820	0.9	1.3	0.8	1.2
R	-20 to 0	2.3	2.8	1.2	1.8
	0 to 100	1.5	2.2	1.1	1.7
	100 to 1767	1.0	1.5	0.9	1.4
S	-20 to 0	2.3	2.8	1.2	1.8
	0 to 200	1.5	2.1	1.1	1.7
	200 to 1400	0.9	1.4	0.9	1.4
	1400 to 1767	1.1	1.7	1.0	1.5
C	0 to 800	0.6	0.9	0.6	0.9
	800 to 1200	0.8	1.2	0.7	1.0
	1200 to 1800	1.1	1.6	0.9	1.4
	1800 to 2316	2.0	3.0	1.3	2.0
L	-200 to -100	0.6	0.9	0.3	0.4
	-100 to 800	0.3	0.4	0.2	0.3
	800 to 900	0.5	0.8	0.2	0.3

Temperature, Thermocouples (cont.)

Type	Range °C	Measure °C		Source °C	
		1 Year	2 Year	1 Year	2 Year
U	-200 to 0	0.6	0.9	0.4	0.6
	0 to 600	0.3	0.4	0.3	0.4

Sensor inaccuracies not included.

Accuracy with external cold junction; for internal junction add 0.2°C

Resolution: 0.1°C

Temperature Scale: ITS-90 or IPTS-68, selectable

Compensation: ITS-90 per NIST Monograph 175 for B,R,S,E,J,K,N,T; IPTS-68 per IEC 584-1 for B,R,S,E,J,K,T;
IPTS-68 per DIN 43710 for L,U.

Temperature Coefficient: 0.05°C/°C in the range -10 to 18°C and 28 to 50°C

Common Mode Error: 0.01°C/(Common Mode Volt)

Maximum Input Voltage: 30V

Temperature, Resistance Temperature Detectors

Temperature, RTDs, Model 741B and 743B					
Type (α)	Range °C	Measure °C		Source °C	
		1 Year	2 Year	1 Year	2 Year
100 Ω Pt(3926)	-200 to 0	0.3	0.4	0.1	0.2
	0 to 630	0.5	0.8	0.2	0.4
100 Ω Pt(385)	-200 to 0	0.3	0.5	0.1	0.2
	0 to 400	0.5	0.8	0.2	0.4
	400 to 800	0.8	1.0	0.4	0.5
120 Ω Ni(672)	-200 to 260	0.3	0.4	0.1	0.2
200 Ω Pt(385)	-200 to 0	0.3	0.5	0.1	0.2
	0 to 400	0.5	0.8	0.2	0.4
	400 to 630	0.8	1.0	0.4	0.5
500 Ω Pt(385)	-200 to 0	0.3	0.5	0.1	0.2
	0 to 400	0.5	0.8	0.2	0.4
	400 to 630	0.8	1.0	0.4	0.5

Temperature, Resistance Temperature Detectors (cont.)

Type (α)	Range °C	Measure °C		Source °C	
		1 Year	2 Year	1 Year	2 Year
1000 Ω Pt(385)	-200 to 0	0.3	0.5	0.1	0.2
	0 to 400	0.5	0.8	0.2	0.4
	400 to 630	0.8	1.0	0.4	0.5
10 Ω Cu(427)	-100 to 0	2	2	1	1
	0 to 260	2	2	1	1
100 Ω Pt(3916)	-200 to -190	0.3	0.4	0.3	0.4
	-190 to 0	0.3	0.4	0.1	0.2
	0 to 360	0.5	0.8	0.2	0.4
<p>Sensor inaccuracies not included Resolution: 0.1°C Temperature Coefficient: 0.02°C/°C in the ranges -10 to 18°C and 28 to 50°C Maximum Input Voltage: 30V Maximum Input Current for RTD Source: 10Ω RTDs: 8 mA dc; 100Ω – 120Ω RTDs: 3 mA dc; 200Ω – 1000Ω RTDs: 1 mA dc</p>					
<p><i>For two and three-wire RTD measurements, add 0.4°C to the specifications.</i></p>					

Loop Power Supply

Setting	Models 741B and 743B	
	1 Year	2 Year
24 Volt	5%	5%
28 Volt	5%	5%
Short circuit protected Maximum Current: 22 mA Maximum Input Voltage: 30V dc		

Top and Bottom Limits of Ranges with Auto Range On

Range, dc V Measure	Top of Range	Bottom of Range
110 mV	±110.000 mV	0.000 mV
1.1V	±1.10000V	±0.10000V
11V	±11.0000V	±1.0000V
110V	±110.000V	±10.000V
300V	±300.00V	±100.00V
Range, dc V Source		
110 mV	+110.000 mV	-10.000 mV
1.1V	+1.10000V	+0.10000V
11V	+11.000V	+1.1000V
Range, ohms Measure and Source		
11Ω	11.000Ω	0.000Ω
110Ω	110.00Ω	10.00Ω
1.1 kΩ	1100.0Ω	100.0Ω
11 kΩ	11.000 kΩ	1.000 kΩ

Top and Bottom Limits of Ranges with Auto Range On (cont.)

Range, Current Measure		
22 mA	+22.000 mA	0.000 mA
110 mA	+110.00 mA	+30.00 mA
Range, Current Source		
22 mA	+30.000 mA	0.000 mA
Range, Frequency Measure		
100 Hz	109.99 Hz	1.00 Hz
1 kHz	1099.9 Hz	100.00 Hz
10 kHz	10.999 kHz	1.000 kHz
50 kHz	50.00 kHz	10.00 kHz

General Specifications

Display:	240 by 200 pixel graphic LCD, 70 x 58 mm.
Power:	Internal battery pack: NiCd, 7.2V, 1700 mAh.
Memory Backup:	Lithium battery, 5 years typical lifetime.
Dimensions:	130 x 236 x 61 mm (5.1 x 9.3 x 2.4 in.).
Weight:	1.4 kg (3 lb. 1 oz.).
Altitude:	Up to 2800 meters (9186 ft) above mean sea level.
Operating Temperature:	-10 to 50°C (typically to -20°C, except for frequency measure and ac voltage measure)
Storage Temperature:	-20 to 60°C
Humidity:	Avoid prolonged use outside the safe operating boundaries shown in the graph on the next page.
Water/Dust Protection:	Designed to meet IEC529 IP52 (normal operating vacuum used for dust test.)
Safety:	Designed in accordance with ANSI/ISA-S82 .01-1994, UL3111, CAN/CSA C22.2 No. 1010.1-92, and EN610-10:1993. See "Safety Information" near the front of this manual.
Warranty:	See the WARRANTY, inside front cover.

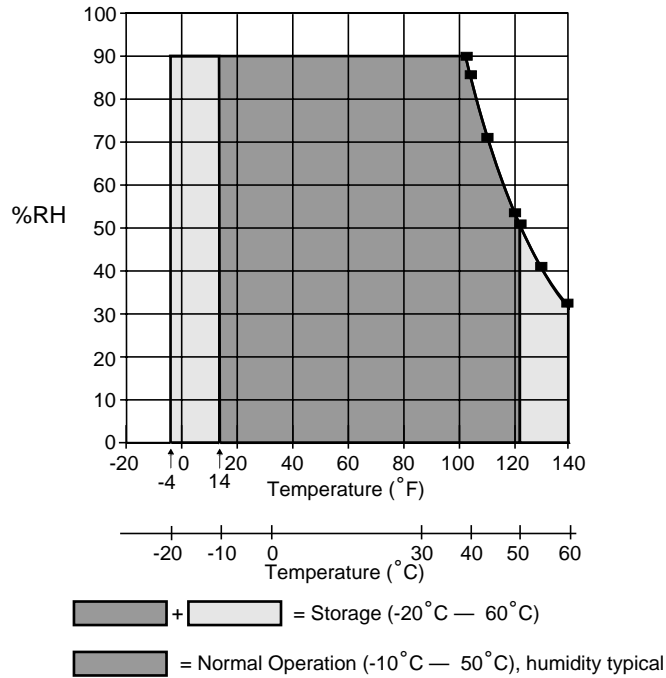

gj37f.eps

Figure 37. LCD Operating Environment Specification

Index

 7, 12, 20, 36, 42

4 to 20 ma transmitter
simulating, 46

—A—

Accessories, 100
As found test data, 66
As left test data, 72
Auto
 backlight timeout, 26
 battery save timeout, 23
Auto step, 59

—B—

Backlight, 26
 auto timeout, 26
Bail, 19
Bar code wand, 3, 80
Battery
 auto save timeout, 23
 charge life, 22
 eliminator, 23
 lithium backup, 97
 replacement, 96
Battery, charging, 20
Battery, removing, 20

—C—

- Calculator, 85
- Calibration, 98
 - data, 97
- Cleaning
 - the calibrator, 97
- Communicating with a PC (743 only), 96
- Connections
 - for electrical measurement, 28
- Continuity
 - testing, 30
 - trip detect during ramping, 60
- Contrast
 - adjusting display, 24
- Current
 - measuring, 28
 - sourcing, 44
- Current shunt, 100
- Customizing mV input units, 42

—D—

- Damping measurements, 43
- Date
 - display, activating, 24
 - format, 24
- Display, 17

- Display language
 - selecting, 24

—F—

- Frequency
 - measuring, 28
 - sourcing, 44

—J—

- Jacks, 12

—K—

- Key functions, 14
- Keys, 14

—L—

- Language
 - selecting, 24
- Limit switch calibration, 74
- Log softkey (743 only), 81
- Logging data (743 only), 81
- Loop power
 - providing, 48
 - simulating, 46

—M—

Measure

mode, 28

Measure/source mode, 63

Measurement

damping, 43

Measuring

continuity, 30

current, 28

electrical parameters, 28

frequency, 28

pressure, 30

resistance, 28

temperature with thermocouples, 34

voltage, 28

Memory, 79

reviewing, 81

Min and Max measurement display, 84

—N—

Name field in setup, 26

—P—

Parts list, 99

Pressure

measuring, 30

sourcing, 50

Pressure modules available, 100

—R—

Ramping the output, 60

Repair, 98

Replacement parts, 99

Resistance

measuring, 28

sourcing, 44

Results

saving, 79

RTD

simulating, 54

types, 34

RTD (Resistance-temperature Detectors), 37

—S—

Saving results, 79

Scale

softkey for measure, 41

temperature, 34, 39

Scale softkey, 41

Servicing, 98

- Simulating, 53
 - loop power, 46
 - thermocouples, 53
- Simultaneous measure/source, 63
- Source
 - mode, 44
- Source mode, 44
- Sourcing
 - current, 44
 - electrical parameters, 44
 - frequency, 44
 - loop power, 48
 - pressure, 50
 - resistance, 44
 - thermocouples, 53
 - voltage, 44
- Square root, delta-flow calibration, 41
- Square-law transmitters, 57
- Standard equipment, 4
- Step size softkey, 58
- Stepping the output, 58
- Strap, 19

—T—

- Task list (743 only), 84
- Telephone number
 - parts, service, or assistance, 4
- Temperature

- Measuring with Thermocouple, 34
 - scale, 34, 39
- Thermocouple
 - measuring, 34
 - measuring temperature with, 34
 - sourcing, 53
 - types, 34
- Time
 - display, activating, 24
 - format, 24
- Transmitter
 - 4 to 20 mA, simulating, 46
- Transmitter mode, 77
- Trip detect during ramping, 60
- Troubleshooting, 97

—U—

- Units
 - custom, 42
 - temperature, 34
- Uploading to a PC (743 only), 96
- User value, 69

—V—

- Voltage
 - measuring, 28
 - sourcing, 44
 - trip detect during ramping, 60



Компания «ЭлектроПласт» предлагает заключение долгосрочных отношений при поставках импортных электронных компонентов на взаимовыгодных условиях!

Наши преимущества:

- Оперативные поставки широкого спектра электронных компонентов отечественного и импортного производства напрямую от производителей и с крупнейших мировых складов;
- Поставка более 17-ти миллионов наименований электронных компонентов;
- Поставка сложных, дефицитных, либо снятых с производства позиций;
- Оперативные сроки поставки под заказ (от 5 рабочих дней);
- Экспресс доставка в любую точку России;
- Техническая поддержка проекта, помощь в подборе аналогов, поставка прототипов;
- Система менеджмента качества сертифицирована по Международному стандарту ISO 9001;
- Лицензия ФСБ на осуществление работ с использованием сведений, составляющих государственную тайну;
- Поставка специализированных компонентов (Xilinx, Altera, Analog Devices, Intersil, Interpoint, Microsemi, Aeroflex, Peregrine, Syfer, Eurofarad, Texas Instrument, Miteq, Cobham, E2V, MA-COM, Hittite, Mini-Circuits, General Dynamics и др.);

Помимо этого, одним из направлений компании «ЭлектроПласт» является направление «Источники питания». Мы предлагаем Вам помощь Конструкторского отдела:

- Подбор оптимального решения, техническое обоснование при выборе компонента;
- Подбор аналогов;
- Консультации по применению компонента;
- Поставка образцов и прототипов;
- Техническая поддержка проекта;
- Защита от снятия компонента с производства.



Как с нами связаться

Телефон: 8 (812) 309 58 32 (многоканальный)

Факс: 8 (812) 320-02-42

Электронная почта: org@eplast1.ru

Адрес: 198099, г. Санкт-Петербург, ул. Калинина, дом 2, корпус 4, литера А.