

High-frequency Relay G6Z

Miniature 2.6-GHz-Band, SPDT, High-frequency Relay

- Superior high-frequency characteristics include an isolation of 30 dB min., insertion loss of 0.5 dB max., and V.S.W.R. of 1.5 max. at 2.6 GHz.
- Triplate micro stripline technology assures superior high-frequency characteristics.
- Miniature dimensions of 20 x 8.6 x 8.9 mm (L x W x H).
- E-shape or Y-shape terminal options with reverse contact arrangements available, allows greater freedom with PCB design.
- Choose between 75-Ω or 50-Ω impedance models
- RoHS Compliant.

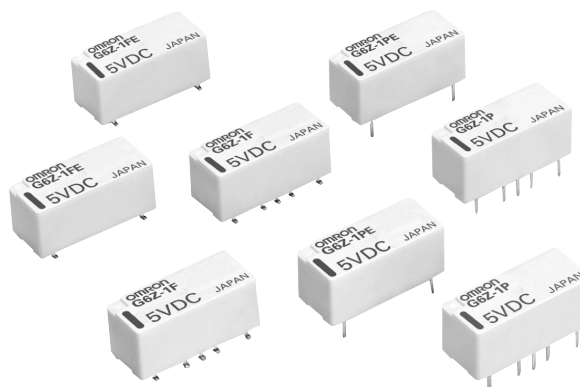

Ordering Information

Classification	Structure	Contact form	Terminal arrangement	Characteristic impedance	Rated coil voltage	Model	
						Through-hole	Surface Mount
Non-latching	Fully sealed	SPDT	E-shape	75 Ω	3, 4.5, 5, 9, 12, and 24 VDC	G6Z-1PE	G6Z-1FE
				50 Ω		G6Z-1PE-A	G6Z-1FE-A
			Y-shape	75 Ω		G6Z-1P	G6Z-1F
				50 Ω		G6Z-1P-A	G6Z-1F-A
Single coil latching			E-shape	75 Ω		G6ZU-1PE	G6ZU-1FE
				50 Ω		G6ZU-1PE-A	G6ZU-1FE-A
			Y-shape	75 Ω		G6ZU-1P	G6ZU-1F
				50 Ω		G6ZU-1P-A	G6ZU-1F-A
Dual coil latching			E-shape	75 Ω	G6ZK-1PE	G6ZK-1FE	
				50 Ω	G6ZK-1PE-A	G6ZK-1FE-A	
			Y-shape	75 Ω	G6ZK-1P	G6ZK-1F	
				50 Ω	G6ZK-1P-A	G6ZK-1F-A	

Notes: 1. When ordering, add the rated coil voltage to the model number.

Example: G6Z-1PE-A-DC12
└─── Rated coil voltage

2. When ordering tape packing (surface mount models), add "-TR" to the model number.

Example: G6ZU-1FE-TR-DC12
└─── Tape packing

"-TR" is not part of the relay model number. Therefore, it is not marked on the relay case.

Model Number Legend:

G6Z - - - DC

1 2 3 4 5 6 7

1. Relay Function

- None: Non-latching
- U: Single coil latching
- K: Dual coil latching

4. Terminal Structure

- None: Y-shape terminal
- E: E-shape terminal

6. Contact arrangement

- None: Standard contact arrangement
- R: Reverse contact arrangement

2. Contact Form

- 1: SPDT

5. Characteristic Impedance

- None: 75 Ω
- A: 50 Ω

7. Rated Coil Voltage

- 3, 4.5, 5, 9, 12, 24

3. Terminal Shape

- F: Surface mount terminals
- P: PCB through-hole terminals

Application Examples

These Relays can be used for switching signals in media equipment.

- **Wire communications:**
Cable TV (STB and broadcasting infrastructure), cable modems, and VRS (video response systems)
- **Wireless communications:**
Transceivers, ham radios, ETC, ITS, high-level TV, satellite broadcasting, text multiplex broadcasting, mobile phone stations, TV broadcasting facilities, community antenna systems and car navigation systems
- **Entertainment equipment:**
TVs, video games, satellite radio units,
- **Industrial equipment:**
Measuring equipment, test equipment, and multiplex transmission devices

Specifications

■ Contact Ratings

Load type	Resistive load
Contact Material	Au clad Cu alloy
Rated load	10 mA at 30 VAC; 10 mA at 30 VDC; 10 W at 900 MHz (See note)
Rated carry current	0.5 A
Max. switching voltage	30 VAC, 30 VDC
Max. switching current	0.5 A

Note: This value is for an impedance of 50 Ω or 75 Ω with a V.S.W.R. of 1.2 max.

■ High-frequency Characteristics

Frequency		900 MHz				2.6 GHz			
		Through hole		Surface mount		Through hole		Surface mount	
Terminal type		Through hole		Surface mount		Through hole		Surface mount	
Terminal structure		E-shape	Y-shape	E-shape	Y-shape	E-shape	Y-shape	E-shape	Y-shape
Isolation	75 Ω	65 dB min.		60 dB min.		35 dB min.	45 dB min.	30 dB min.	40 dB min.
	50 Ω	60 dB min.							
Insertion loss (not including substrate loss)	75 Ω	0.2 dB max.				0.5 dB max.			
	50 Ω	0.1 dB max.				0.3 dB max.			
V.S.W.R.	75 Ω	1.2 max.				1.5 max.			
	50 Ω	1.1 max.				1.3 max.			
Return loss	75 Ω	20.8 dB max.				14.0 dB max.			
	50 Ω	26.4 dB max.				17.7 dB max.			
Maximum carry power		10 W (See note 2)							
Maximum switching power		10 W (See note 2)							

- Note: 1. The above values are initial values.
 2. These values are for an impedance of 50 Ω or 75 Ω with a V.S.W.R. of 1.2 max.

■ Coil Ratings

Non-latching, Standard and Reverse-contact Models G6Z-1P(E), G6Z-1F(E)

Rated voltage (VDC)	Rated current (mA)	Coil resistance (Ω)	Must operate voltage (VDC)	Must dropout voltage (VDC)	Maximum voltage (VDC)	Power consumption (mW)
3	66.7	45	75% max. of rated voltage	10% min. of rated voltage	150% of rated voltage	Approx. 200
4.5	44.4	101				
5	40.0	125				
9	22.2	405				
12	16.7	720				
24	8.3	2,880				

Single Coil Latching Models G6ZU-1P(E), G6ZU-1F(E)

Rated voltage (VDC)	Rated current (mA)	Coil resistance (Ω)	Must set voltage (VDC)	Must reset voltage (VDC)	Maximum voltage (VDC)	Power consumption (mW)
3	66.7	45	75% max. of rated voltage	75% max. of rated voltage	150% of rated voltage	Approx. 200
4.5	44.4	101				
5	40.0	125				
9	22.2	405				
12	16.7	720				
24	8.3	2,880				

Dual Coil Latching Models G6ZK-1P(E), G6ZK-1F(E)

Rated voltage (VDC)	Rated current (mA)	Coil resistance (Ω)	Must set voltage (VDC)	Must reset voltage (VDC)	Maximum voltage (VDC)	Power consumption (mW)
3	120	25	75% max. of rated voltage	75% max. of rated voltage	150% of rated voltage	Approx. 360
4.5	80	56				
5	72	69				
9	40	225				
12	30	400				
24	15	1,600				

- Note:**
1. The rated current and coil resistance are measured at a coil temperature of 23°C with a tolerance of ±10%.
 2. The operating characteristics are measured at a coil temperature of 23°C.
 3. The maximum voltage is the highest voltage that can be imposed on the relay coil instantaneously.
 4. The voltage measurements for operate/release and set/reset are the values obtained for instantaneous changes in the voltage (rectangular wave).

Characteristics

Item	Non-latching models		Single coil latching models	Dual coil latching models
	G6Z-1P(E), G6Z-1F(E)		G6ZU-1P(E), G6ZU-1F(E)	G6ZK-1P(E), G6ZK-1F(E)
Contact resistance (See note 2)	100 mΩ max.			
Operating (set) time (See note 3)	10 ms max. (approx. 3.5 ms)		10 ms max. (approx. 2.5 ms)	
Release (reset) time (See note 3)	10 ms max. (approx. 2.5 ms)			
Set/reset time	---		12 ms	
Insulation resistance (See note 4)	100 MΩ min. (at 500 VDC)			
Dielectric strength	Coil and contacts	1,000 VAC, 50/60 Hz for 1 min.		
	Coil and ground, contacts and ground	500 VAC, 50/60 Hz for 1 min.		
	Contacts of same polarity	500 VAC, 50/60 Hz for 1 min.		
Vibration resistance	Mechanical durability	10 to 55 to 10 Hz, 0.75-mm single amplitude (1.5-mm double amplitude)		
	Malfunction durability	10 to 55 to 10 Hz, 0.75-mm single amplitude (1.5-mm double amplitude)		
Shock resistance	Mechanical durability	1,000 m/s ²		
	Malfunction durability	500 m/s ²		
Service life	Mechanical	1,000,000 operations min. (at 36,000 operations/hour)		
	Electrical	300,000 operations min. (30 VAC, 10 mA/30 VDC, 10 mA), 100,000 operations min. (900 MHz, 10 W) at a switching frequency of 1,800 operations/hour		
Ambient temperature	Operating: -40°C to 70°C (with no icing or condensation)			
Ambient humidity	Operating: 5% to 85% RH			
Weight	Approx. 2.8 g			

- Note:**
- The above values are initial values.
 - The contact resistance was measured with 10 mA at 1 VDC with a voltage drop method.
 - Values in parentheses are typical values.
 - The insulation resistance was measured with a 500-VDC megohmmeter applied to the same parts as those used for checking the dielectric strength.

Engineering Data

Ambient Temperature vs. Maximum Voltage

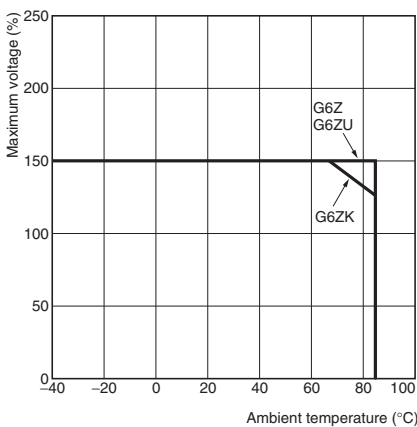

Ambient Temperature vs. Must Operate or Must Release Voltage

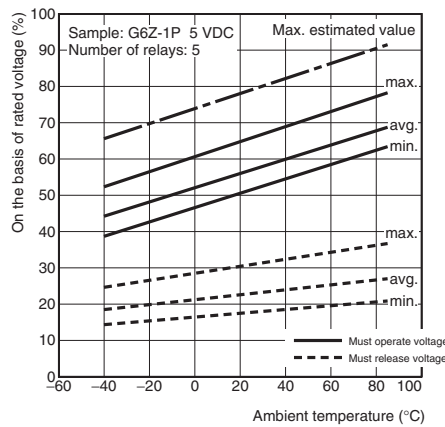

Shock Malfunction

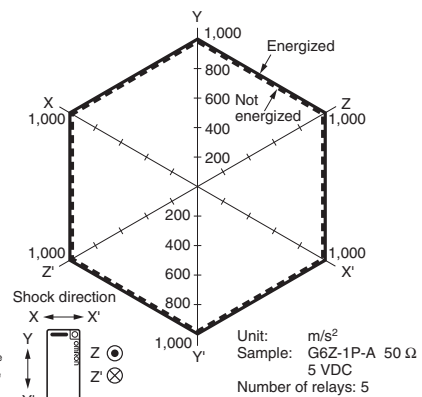

Conditions: Shock is applied in ±X, ±Y, and ±Z directions three times each with and without energizing the Relays to check for contact malfunctions.

Electrical Endurance (with Must Operate and Must Release Voltage)

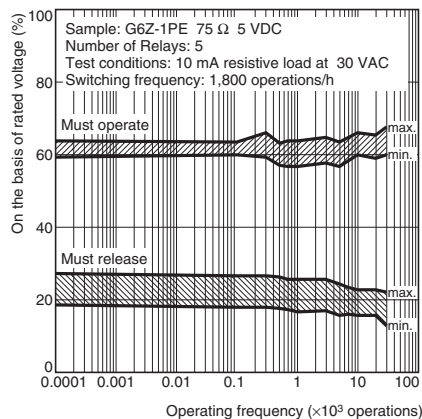

Electrical Endurance (with Must Operate and Must Release Voltage)

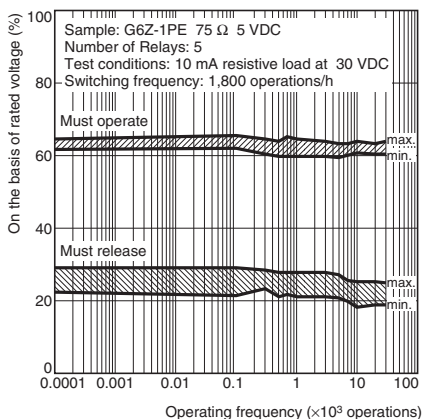

Electrical Endurance (Contact Resistance)

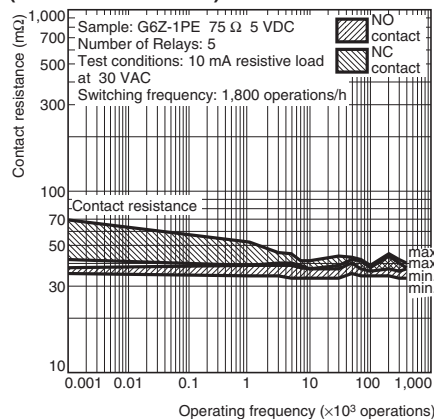

Electrical Endurance (Contact Resistance)

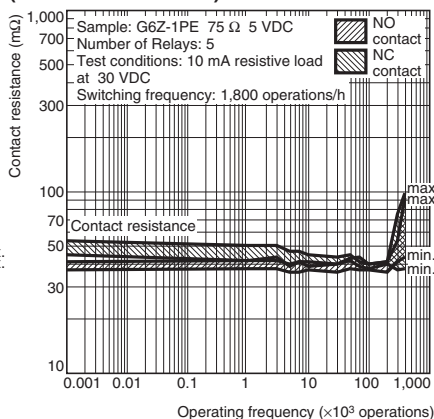

External Magnetic Interference (Average value)

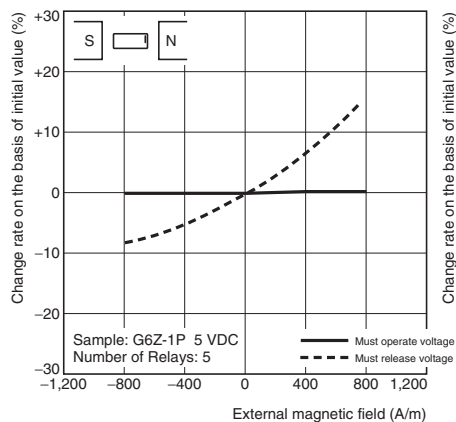

(Average value)

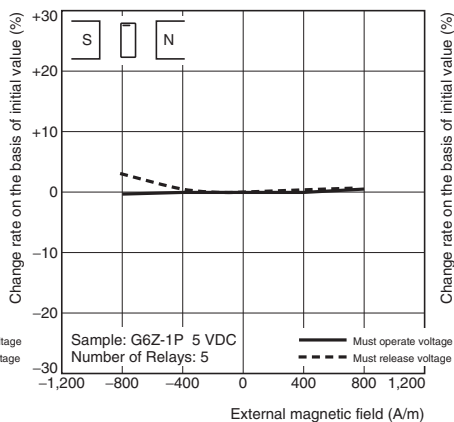

(Average value)

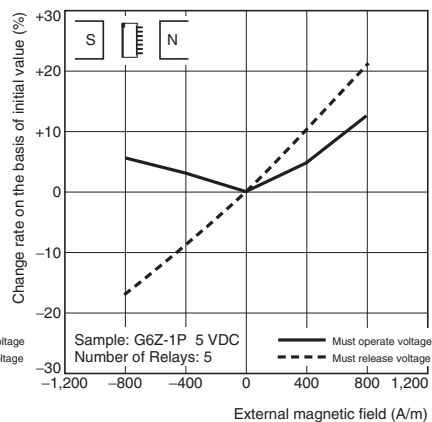

Note: 1. The tests were conducted at an ambient temperature of 23°C.

2. The contact resistance data are periodically measured reference values and are not values from monitoring each operation. Contact resistance values will vary according to the switching frequency and operating environment, so be sure to check operation under the actual operating conditions before use.

High-frequency Characteristics at 75 Ω (Isolation)

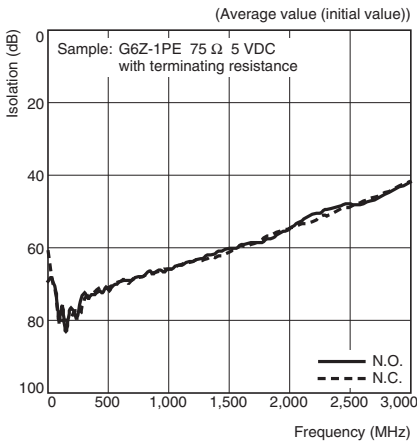

High-frequency Characteristics at 75 Ω (Insertion Loss)

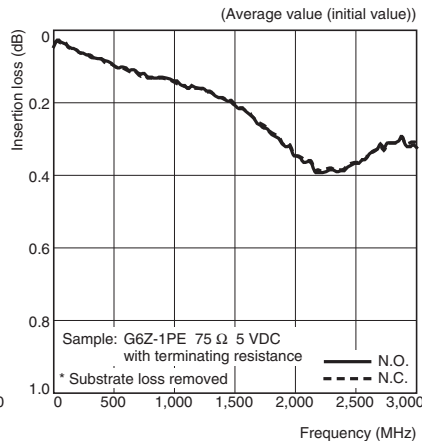

High-frequency Characteristics at 75 Ω (Return Loss, V.S.W.R.)

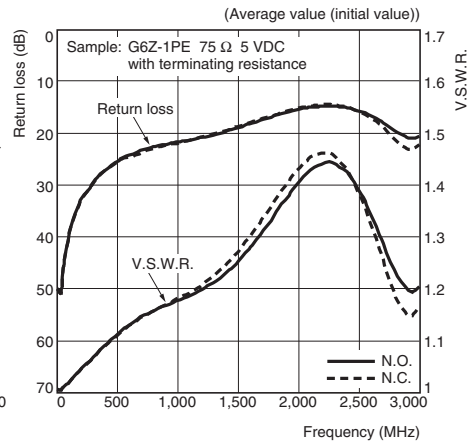

High-frequency Characteristics at 50 Ω (Isolation)

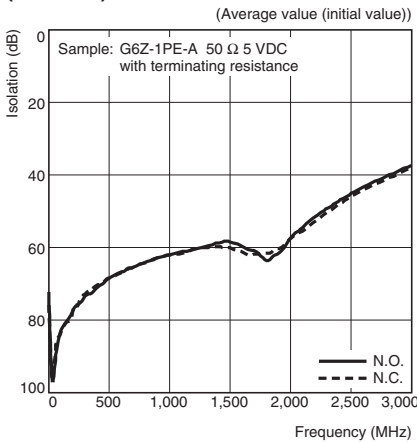

High-frequency Characteristics at 50 Ω (Insertion Loss)

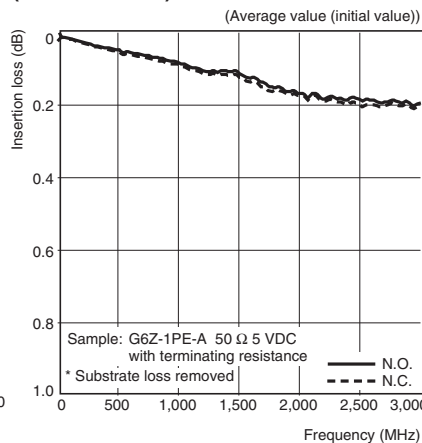

High-frequency Characteristics at 50 Ω (Return Loss, V.S.W.R.)

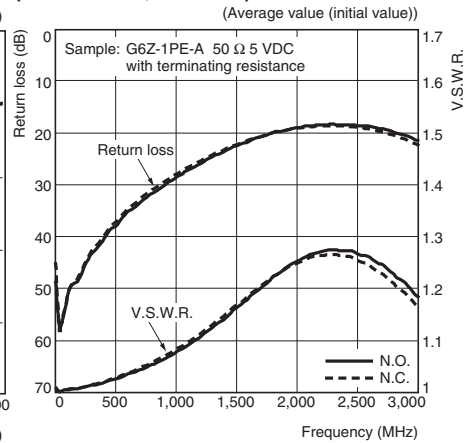

Must Operate and Must Release Time Distribution (See note.)

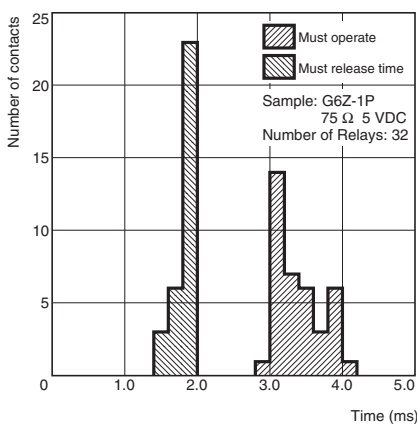

Must Operate and Must Release Bounce Time Distribution (See note.)

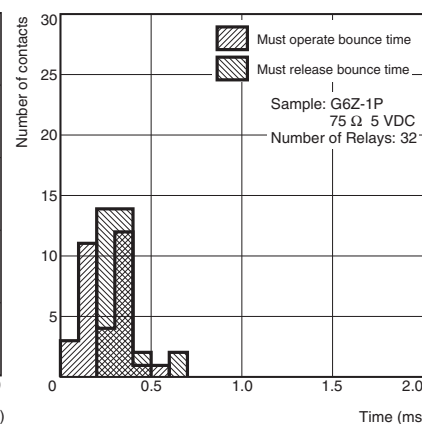

Note: 1. The tests were conducted at an ambient temperature of 23°C.

2. High-frequency characteristics depend upon the PCB to which the relay is mounted. Always check these characteristics, including endurance (service life), in the actual machine before use.

Dimensions

Note: All units are in millimeters unless otherwise indicated.

PCB Through-hole Terminal Types

G6Z-1PE
G6Z-1PE-R
G6ZU-1PE

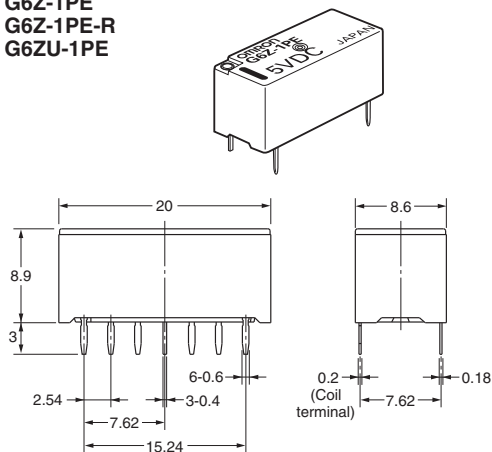

Mounting Dimensions (Bottom View)
Tolerance: ± 0.1 mm

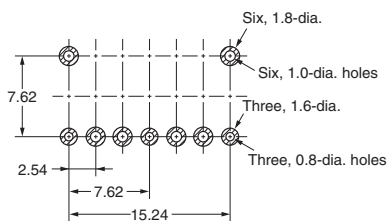

Terminal Arrangement/Internal Connections (Bottom View)

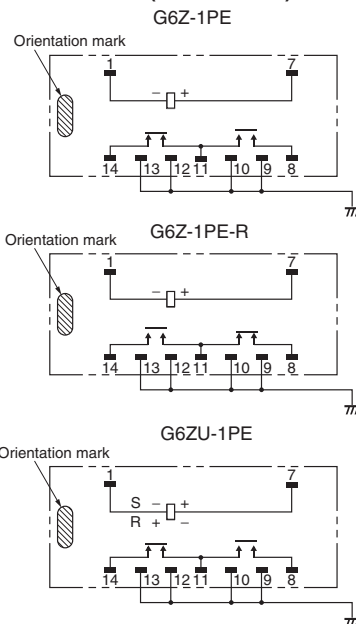

Note: Each value has a tolerance of ± 0.3 mm.

G6Z-1PE-A
G6ZU-1PE-A

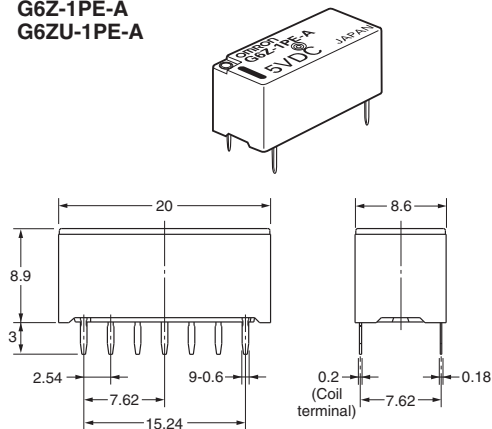

Mounting Dimensions (Bottom View)
Tolerance: ± 0.1 mm

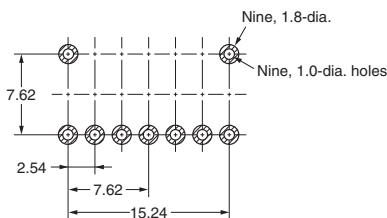

Terminal Arrangement/Internal Connections (Bottom View)

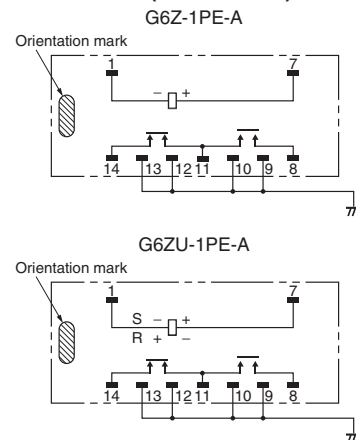

Note: Each value has a tolerance of ± 0.3 mm.

**G6Z-1P
G6ZU-1P**

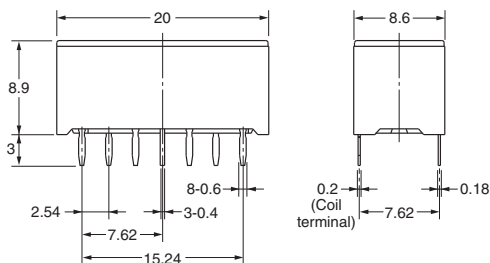
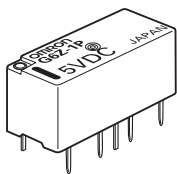

Note: Each value has a tolerance of ± 0.3 mm.

Mounting Dimensions (Bottom View)
Tolerance: ± 0.1 mm

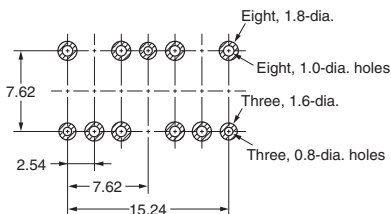

Terminal Arrangement/Internal Connections (Bottom View)

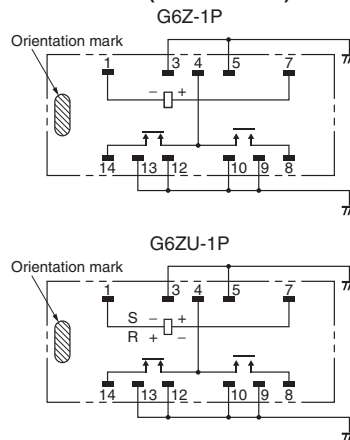

**G6Z-1P-A
G6ZU-1P-A**

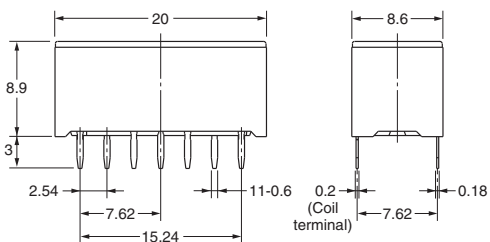
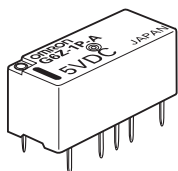

Note: Each value has a tolerance of ± 0.3 mm.

Mounting Dimensions (Bottom View)
Tolerance: ± 0.1 mm

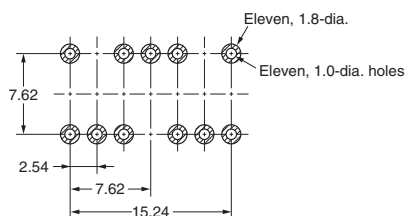

Terminal Arrangement/Internal Connections (Bottom View)

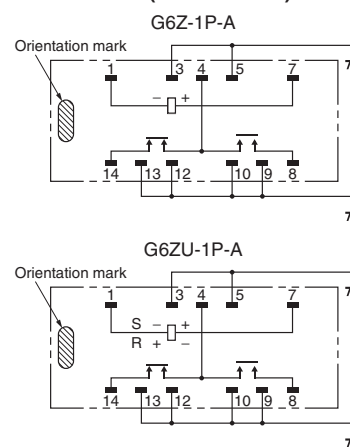

G6ZK-1PE

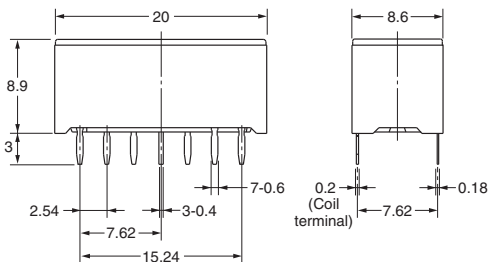
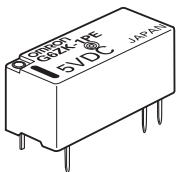

Note: Each value has a tolerance of ± 0.3 mm.

Mounting Dimensions (Bottom View)
Tolerance: ± 0.1 mm

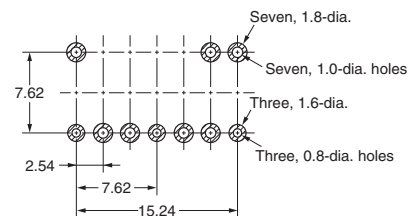

Terminal Arrangement/Internal Connections (Bottom View)

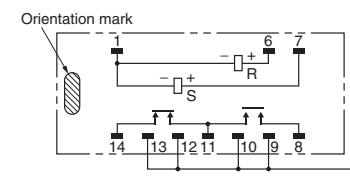

G6ZK-1PE-A

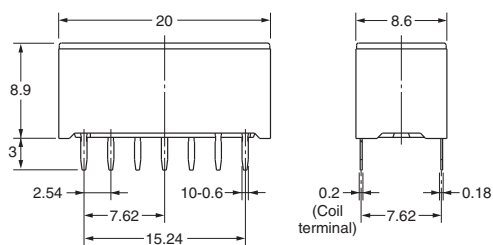
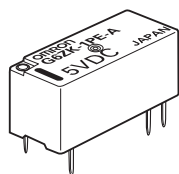

Note: Each value has a tolerance of ± 0.3 mm.

Mounting Dimensions (Bottom View)
Tolerance: ± 0.1 mm

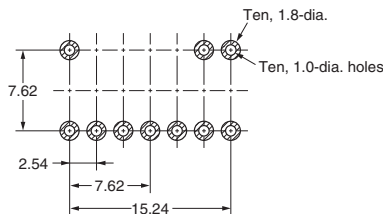

Terminal Arrangement/Internal Connections (Bottom View)

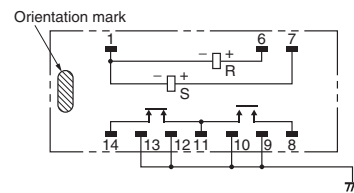

G6ZK-1P

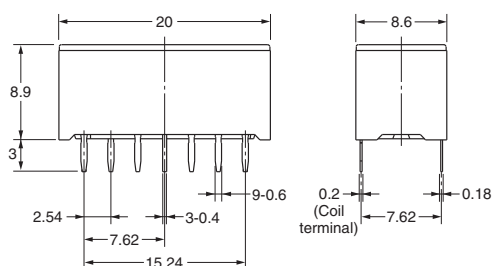
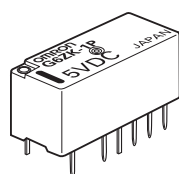

Note: Each value has a tolerance of ± 0.3 mm.

Mounting Dimensions (Bottom View)
Tolerance: ± 0.1 mm

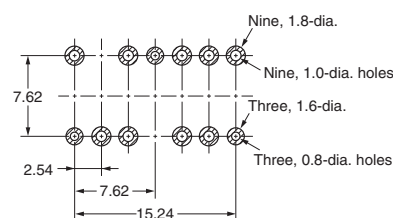

Terminal Arrangement/Internal Connections (Bottom View)

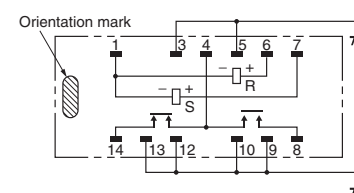

G6ZK-1P-A

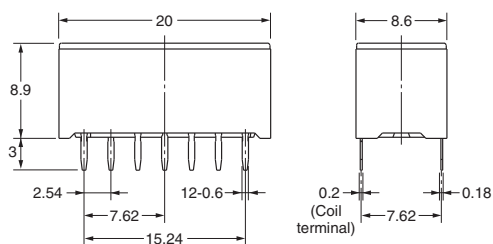
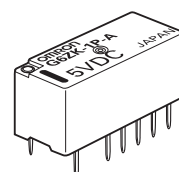

Note: Each value has a tolerance of ± 0.3 mm.

Mounting Dimensions (Bottom View)
Tolerance: ± 0.1 mm

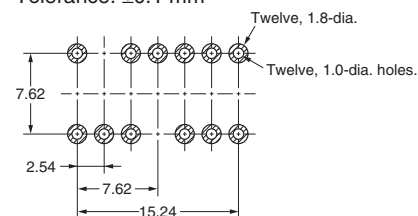

Terminal Arrangement/Internal Connections (Bottom View)

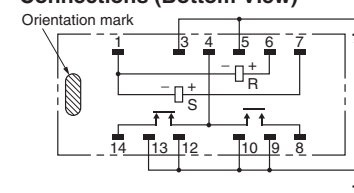

■ Surface Mount Terminal Types

G6Z-1FE
G6ZU-1FE

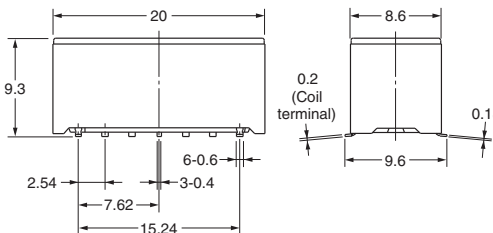
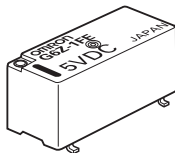

Mounting Dimensions (Top View)
Tolerance: ± 0.1 mm

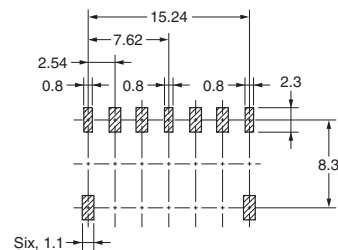

Terminal Arrangement/Internal Connections (Top View)

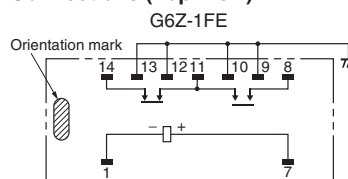

Note 1: Each value has a tolerance of ± 0.3 mm.
2: The coplanarity of the terminals is 0.1 mm max.

G6Z-1FE-A
G6ZU-1FE-A

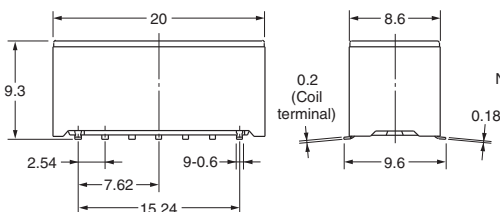
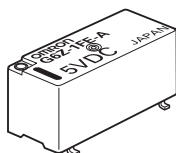

Mounting Dimensions (Top View)
Tolerance: ± 0.1 mm

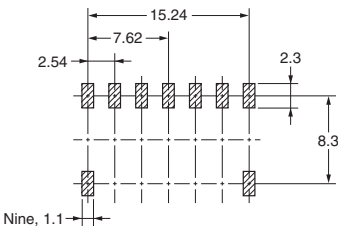

Terminal Arrangement/Internal Connections (Top View)

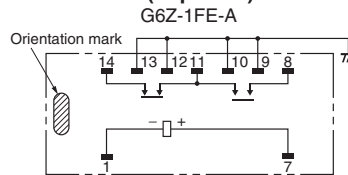

Note 1: Each value has a tolerance of ± 0.3 mm.
2: The coplanarity of the terminals is 0.1 mm max.

G6Z-1F
G6ZU-1F

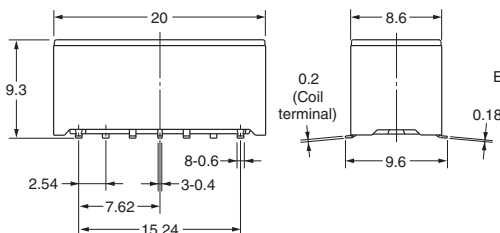
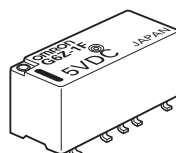

Mounting Dimensions (Top View)
Tolerance: ± 0.1 mm

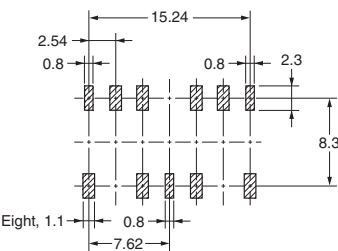

Terminal Arrangement/Internal Connections (Top View)

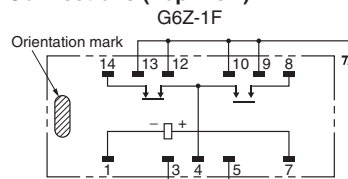

Note 1: Each value has a tolerance of ± 0.3 mm.
2: The coplanarity of the terminals is 0.1 mm max.

**G6Z-1F-A
G6ZU-1F-A**

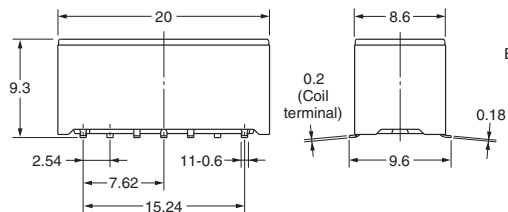
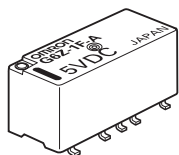

Note 1: Each value has a tolerance of ± 0.3 mm.
Note 2: The coplanarity of the terminals is 0.1 mm max.

Mounting Dimensions (Top View)

Tolerance: ± 0.1 mm

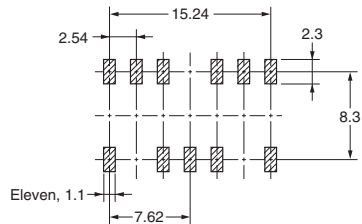

Terminal Arrangement/Internal Connections (Top View)

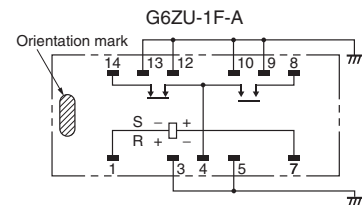
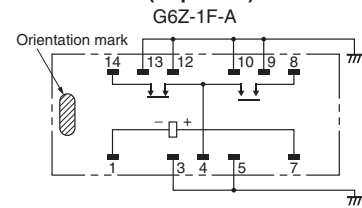

G6ZK-1FE

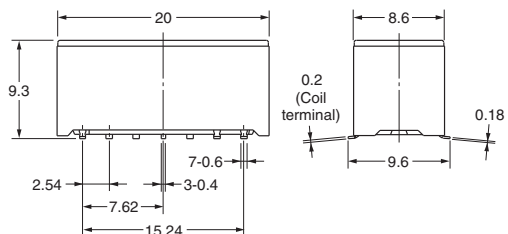
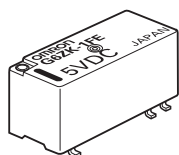

Note 1: Each value has a tolerance of ± 0.3 mm.
Note 2: The coplanarity of the terminals is 0.1 mm max.

Mounting Dimensions (Top View)

Tolerance: ± 0.1 mm

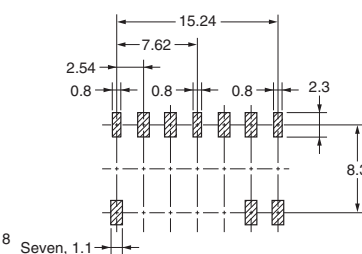

Terminal Arrangement/Internal Connections (Top View)

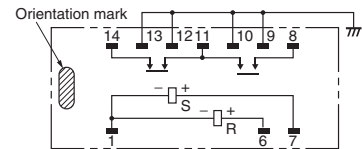

G6ZK-1FE-A

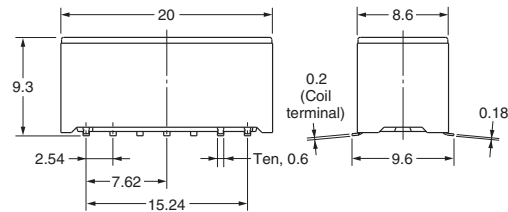
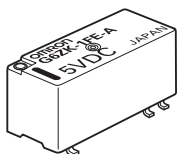

Note 1: Each value has a tolerance of ± 0.3 mm.
Note 2: The coplanarity of the terminals is 0.1 mm max.

Mounting Dimensions (Top View)

Tolerance: ± 0.1 mm

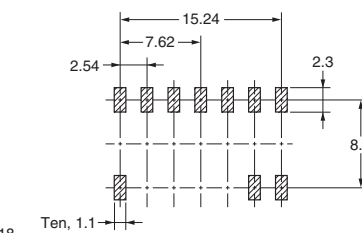

Terminal Arrangement/Internal Connections (Top View)

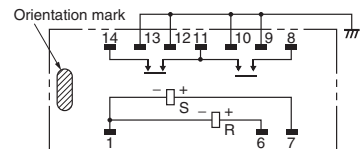

G6ZK-1F

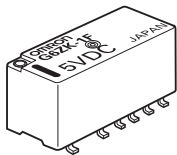

Mounting Dimensions (Top View)

Tolerance: ± 0.1 mm

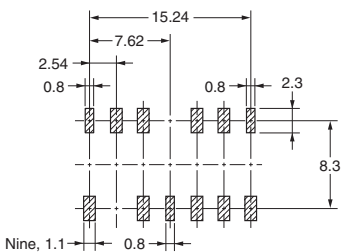
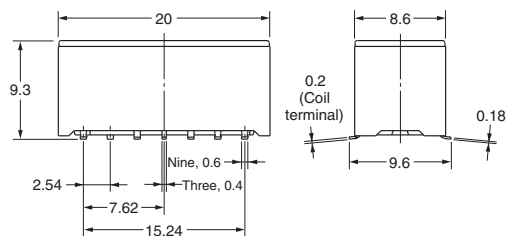

Terminal Arrangement/Internal Connections (Top View)

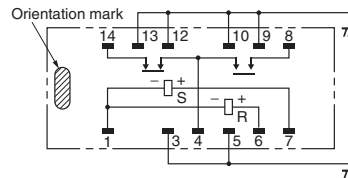

- Note 1:** Each value has a tolerance of ± 0.3 mm.
Note 2: The coplanarity of the terminals is 0.1 mm max.

G6ZK-1F-A

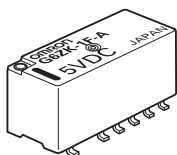

Mounting Dimensions (Top View)

Tolerance: ± 0.1 mm

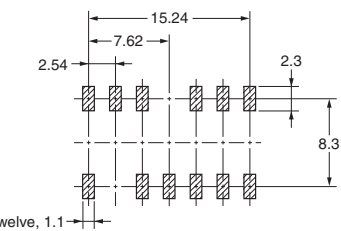
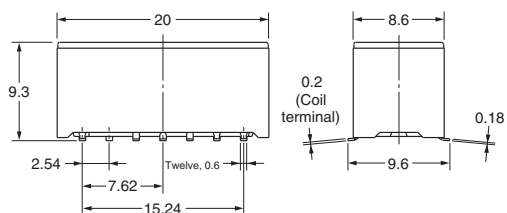

Terminal Arrangement/Internal Connections (Top View)

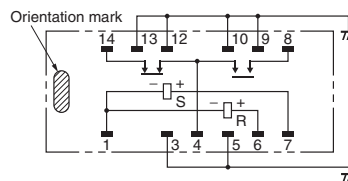

- Note 1:** Each value has a tolerance of ± 0.3 mm.
Note 2: The coplanarity of the terminals is 0.1 mm max.

Packaging

1. Tube Packaging

Relays in tube packaging are arranged so that the orientation mark of each Relay is on the left side.

Be sure not to make mistakes in Relay orientation when mounting the Relay to the PCB.

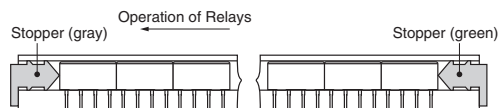

Tube length: 530 mm (stopper not included)
No. of Relays per tube: 25

2. Tape and Reel Packaging (Surface mount Terminal Models)

When ordering Relays in tape packing, add the prefix “-TR” to the model number, otherwise the Relays in stick packing will be provided.

Relays per Reel: 300

Direction of Relay Insertion

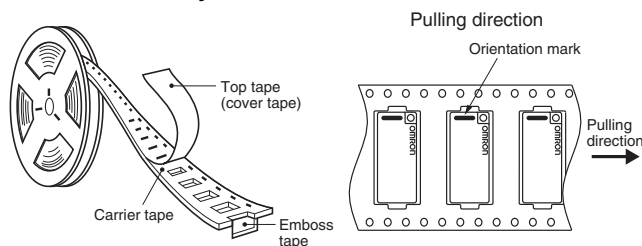

Reel Dimensions

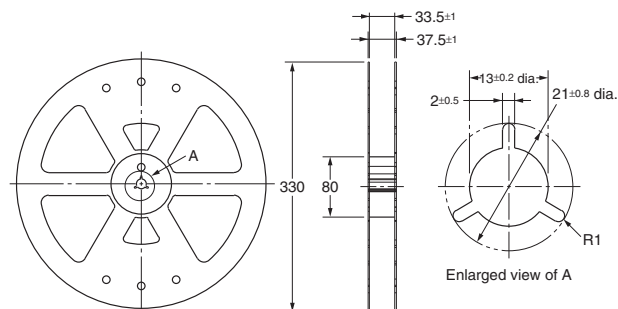

Carrier Tape Dimensions

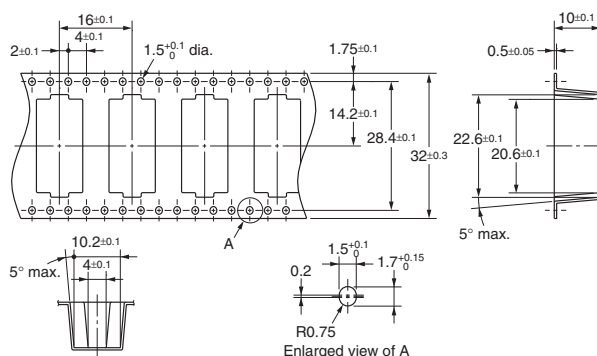

Note: The radius of the unmarked corner is 0.3 mm.

Recommended Soldering Method

Temperature Conditions for IRS Method

When using reflow soldering, ensure that the Relay terminals and the top of the case stay below the following curve. Check that these conditions are actually satisfied before soldering the terminals.

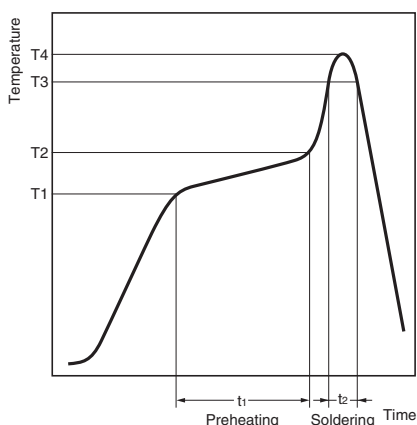

Do not quench the terminals after mounting. Clean the Relay using alcohol or water no hotter than 40°C max.

The thickness of cream solder to be applied should be between 150 and 200 μm on OMRON's recommended PCB pattern.

Correct Soldering

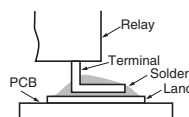

Incorrect Soldering

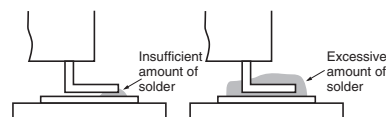

Check the soldering in the actual mounting conditions before use.

Measured part	Preheating (T1 → T2, t1)	Soldering (T3, t2)	Maximum peak (T4)
Terminals	150 → 180°C, 120 s max.	230°C min, 30 s max.	250°C max.
Top of case	---	---	255°C max.

Safety Precautions

■ Precautions for Correct Use

Please observe the following precautions to prevent failure to operate, malfunction, or undesirable effect on product performance.

High-frequency Characteristics Measurement Method and Measurement Substrate

High-frequency characteristics for the G6Z are measured in the way shown below. Consult your OMRON representative for details on 50-Ω models.

Measurement Method for 75-Ω Models

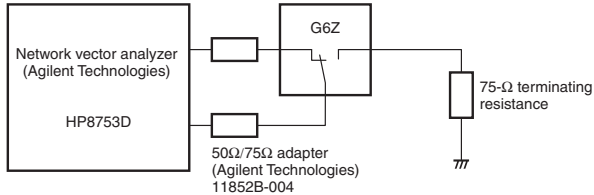

Through-hole Substrate (75-Ω Models, E-shape or Y-shape)

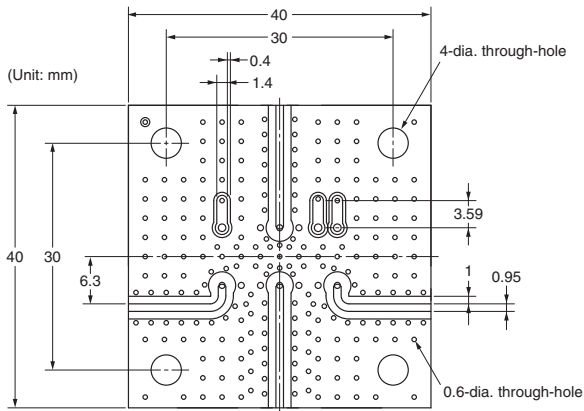

SMD-type Substrate (75-Ω Models, E-shape or Y-shape)

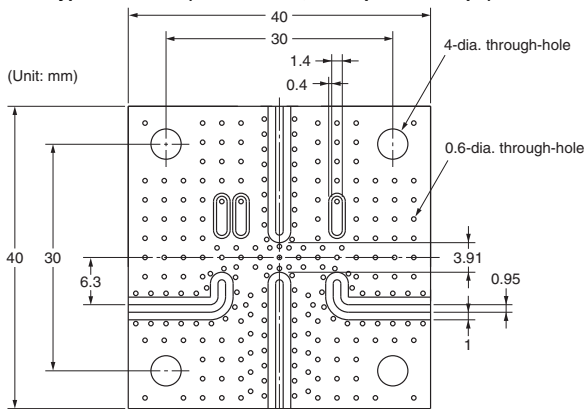

Substrate for High-frequency Characteristic Compensation (75-Ω Models, E-shape or Y-shape)

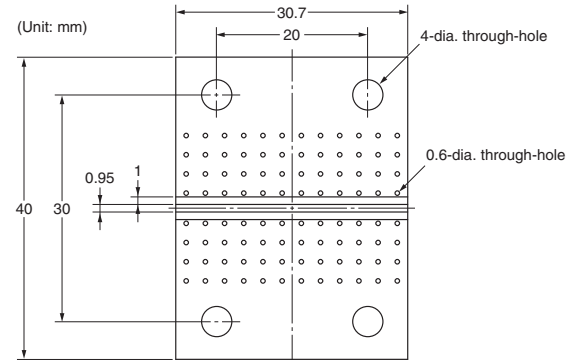

Substrate Types

Material: FR-4 glass epoxy (glass cloth impregnated with epoxy resin and copper laminated to its outer surface)

Thickness: 1.6 mm

Thickness of copper plating: 18 μm

Note: 1. The compensation substrate is used when measuring the Relay's insertion loss. The insertion loss is obtained by subtracting the measured value for the compensation substrate from the measured value with the Relay mounted to the high-frequency measurement substrate.

Note: 2. For convenience, the diagrams of the high-frequency measurement substrates given here apply both to models with an E-shape terminal structure and to models with a Y-shape terminal structure.

Note: 3. Be sure to mount a standoff tightly to the through-hole substrate.

Note: 4. Use measuring devices, connectors, and substrates that are appropriate for 50 Ω and 75 Ω respectively.

Note: 5. Ensure that there is no pattern under the Relay. Otherwise, the impedance may be adversely affected and the Relay may not be able to attain its full characteristics.

Handling

Do not use the Relay if it has been dropped. Dropping the Relay may adversely affect its functionality.

Protect the Relay from direct sunlight and keep the Relay under normal temperature, humidity, and pressure.

Flow Soldering

Solder: JIS Z3282, H63A

Soldering temperature: Approx. 250°C (260°C if the DWS method is used)

Soldering time: Approx. 5 s max. (approx. 2 s for the first time and approx. 3 s for the second time if the DWS method is used)

Be sure to make a molten solder level adjustment so that the solder will not overflow on the PCB.

Claw Securing Force During Automatic Mounting

During automatic insertion of Relays, be sure to set the securing force of each claw to the following so that the Relay's characteristics will be maintained.

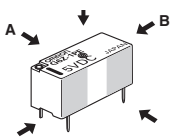

Direction A: 4.90 N max.
Direction B: 4.90 N max.
Direction C: 4.90 N max.

Secure the claws to the shaded area.
Do not attach them to the center area
or to only part of the Relay.

Latching Relay Mounting

Make sure that the vibration or shock that is generated from other devices, such as Relays, on the same panel or substrate and imposed on the Latching Relay does not exceed the rated value, otherwise the set/reset status of the Latching Relay may be changed. The Latching Relay is reset before shipping. If excessive vibration or shock is imposed, however, the Latching Relay may be set accidentally. Be sure to apply a reset signal before use.

Coating

Do not use silicone coating to coat the Relay when it is mounted to the PCB. Do not wash the PCB after the Relay is mounted using detergent containing silicone. Otherwise, the detergent may remain on the surface of the Relay.

All sales are subject to Omron Electronic Components LLC standard terms and conditions of sale, which can be found at http://www.components.omron.com/components/web/webfiles.nsf/sales_terms.html

ALL DIMENSIONS SHOWN ARE IN MILLIMETERS.

To convert millimeters into inches, multiply by 0.03937. To convert grams into ounces, multiply by 0.03527.

OMRON[®]

**OMRON ELECTRONIC
COMPONENTS LLC**

55 E. Commerce Drive, Suite B
Schaumburg, IL 60173

847-882-2288

OMRON ON-LINE

Global - <http://www.omron.com>

USA - <http://www.components.omron.com>

Cat. No. X301-E-1b

09/11

Specifications subject to change without notice

Printed in USA



Компания «ЭлектроПласт» предлагает заключение долгосрочных отношений при поставках импортных электронных компонентов на взаимовыгодных условиях!

Наши преимущества:

- Оперативные поставки широкого спектра электронных компонентов отечественного и импортного производства напрямую от производителей и с крупнейших мировых складов;
- Поставка более 17-ти миллионов наименований электронных компонентов;
- Поставка сложных, дефицитных, либо снятых с производства позиций;
- Оперативные сроки поставки под заказ (от 5 рабочих дней);
- Экспресс доставка в любую точку России;
- Техническая поддержка проекта, помощь в подборе аналогов, поставка прототипов;
- Система менеджмента качества сертифицирована по Международному стандарту ISO 9001;
- Лицензия ФСБ на осуществление работ с использованием сведений, составляющих государственную тайну;
- Поставка специализированных компонентов (Xilinx, Altera, Analog Devices, Intersil, Interpoint, Microsemi, Aeroflex, Peregrine, Syfer, Eurofarad, Texas Instrument, Miteq, Cobham, E2V, MA-COM, Hittite, Mini-Circuits, General Dynamics и др.);

Помимо этого, одним из направлений компании «ЭлектроПласт» является направление «Источники питания». Мы предлагаем Вам помощь Конструкторского отдела:

- Подбор оптимального решения, техническое обоснование при выборе компонента;
- Подбор аналогов;
- Консультации по применению компонента;
- Поставка образцов и прототипов;
- Техническая поддержка проекта;
- Защита от снятия компонента с производства.



Как с нами связаться

Телефон: 8 (812) 309 58 32 (многоканальный)

Факс: 8 (812) 320-02-42

Электронная почта: org@eplast1.ru

Адрес: 198099, г. Санкт-Петербург, ул. Калинина, дом 2, корпус 4, литера А.