



Micro Commercial Components



Micro Commercial Components
20736 Marilla Street Chatsworth
CA91311
Phone: (818) 701-4933
Fax: (818) 701-4939

ESD5V0D3 Thru ESD12VD3

Features

- Halogen free available upon request by adding suffix "-HF"
- For sensitive ESD protection
- Excellent clamping capability
- Low leakage
- ESD rating of class 3(>16KV)per Human Body Mode
- For space saving application
- Fast response ,response time less than 1ns.
- Epoxy meets UL 94 V-0 flammability rating
- Moisture Sensitivity Level 1

Maximum Ratings

- Operating Junction & Storage Temperature: -55°C to +150°C
- Maximum Thermal Resistance: 625°C/W Junction To Ambient

Parameter	Symbol	Limits	unit
IEC61000-4-2(ESD) Air Contact		±15 ±8	KV
ESD Voltage per human body mode		30	KV
Power Dissipation	Pd	200	mw

5V~12Volts ESD Protection Devices

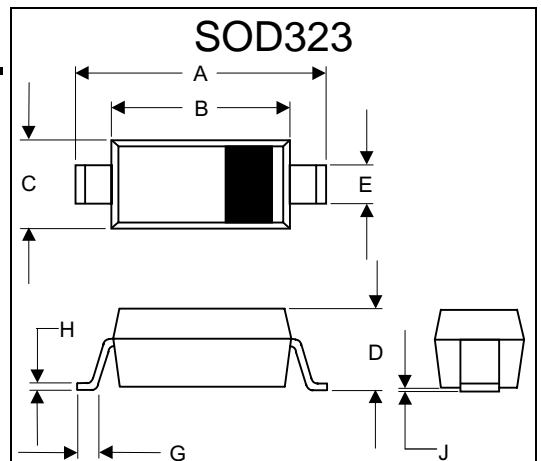

DIM	INCHES		MM		NOTE
	MIN	MAX	MIN	MAX	
A	.090	.107	2.30	2.70	
B	.063	.071	1.60	1.80	
C	.045	.053	1.15	1.35	
D	.031	.045	0.80	1.15	
E	.010	.016	0.25	0.40	
G	.004	.018	0.10	0.45	
H	.004	.010	0.10	0.25	
J	-----	.006	-----	0.15	

SUGGESTED SOLDER PAD LAYOUT

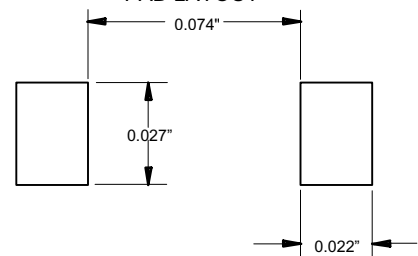

ELECTRICAL CHARACTERISTICS ($T_A = 25^\circ\text{C}$ unless otherwise noted)

Symbol	Parameter
I_{PP}	Maximum Reverse Peak Pulse Current
V_C	Clamping Voltage @ I_{PP}
V_{RWM}	Working Peak Reverse Voltage
I_R	Maximum Reverse Leakage Current @ V_{RWM}
V_{BR}	Breakdown Voltage @ I_T
I_T	Test Current
I_F	Forward Current
V_F	Forward Voltage @ I_F
P_{pk}	Peak Power Dissipation
C	Max. Capacitance @ $V_R=0$ and $f=1\text{MHz}$

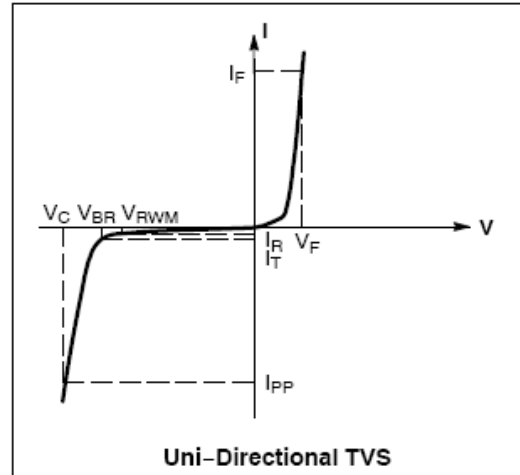

ELECTRICAL CHARACTERISTICS ($T_A = 25^\circ\text{C}$ unless otherwise noted, $V_F = 0.9\text{ V Max.}$ @ $I_F = 10\text{mA}$ for all types)

Device	Device Marking	V_{RWM}	$I_R (\mu\text{A})$	$V_{BR} (\text{V})$		I_T	V_C	$I_{PP}(\text{A})^+$	$V_C (\text{V})$	P_{pk}^+	C
		(V)	@ V_{RWM}	@ $I_T(\text{Note 2})$	Min		Max		@ $I_{PP} = 5\text{ A}$		
		Max	Max			mA	V	Max	Max	Max	Typ
ESD5V0D3	ZA	5.0	1.0	6.2	7.3	1.0	9.8	15	15.5	350	350
ESD12VD3	ZC	12	1.0	13.3	15.75	1.0	22	12	33	350	150

+Surge current waveform per Figure 6.

2. V_{BR} is measured with a pulse test current I_T at an ambient temperature of 25°C .

TYPICAL CHARACTERISTICS

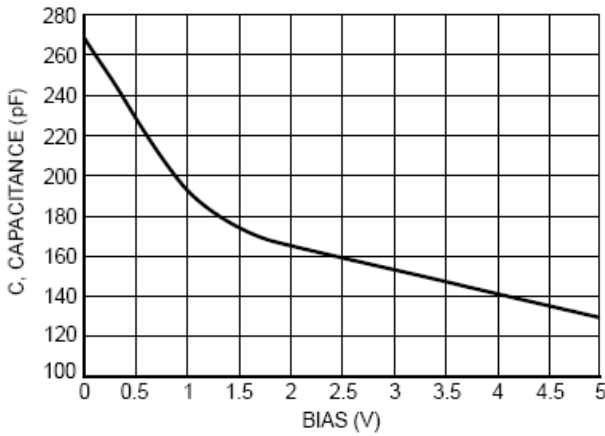

Figure 1. SD05 Typical Capacitance versus Bias Voltage

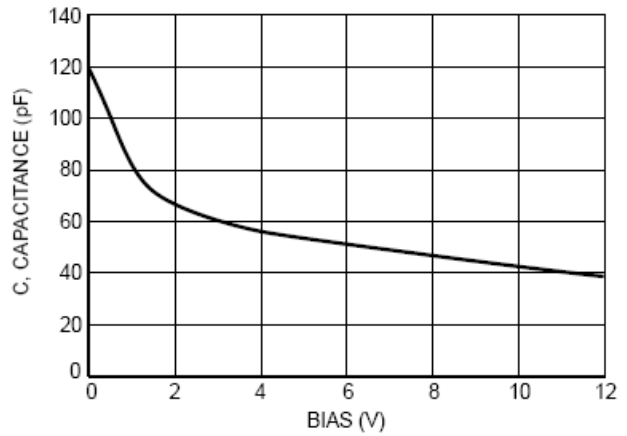

Figure 2. SD12 Typical Capacitance versus Bias Voltage

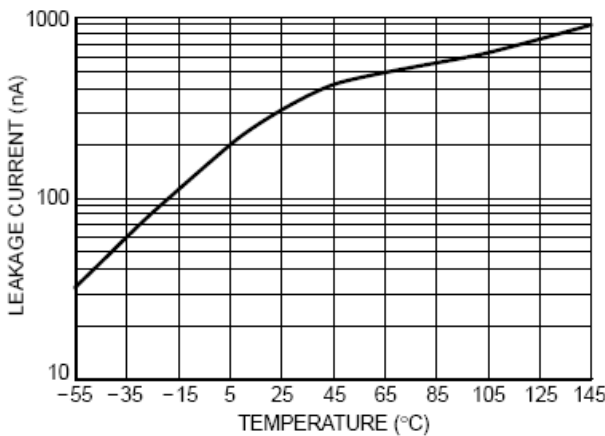

Figure 3. SD05 Typical Leakage Current versus Temperature

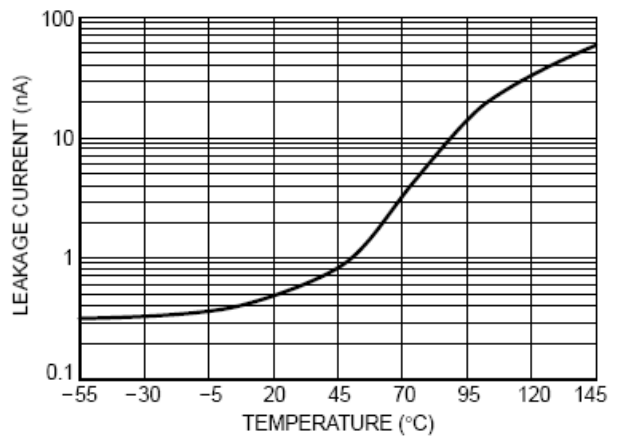

Figure 4. SD12 Typical Leakage Current versus Temperature

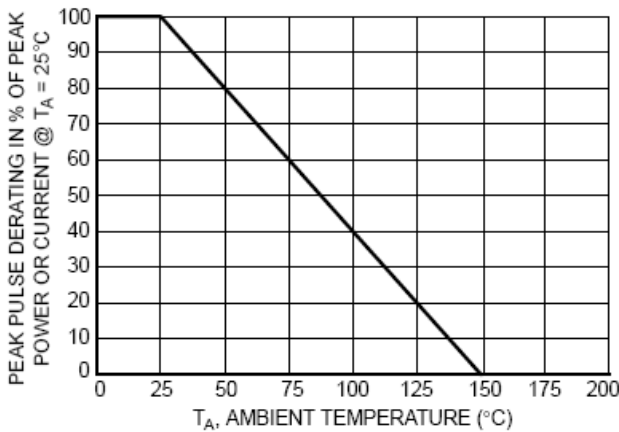

Figure 5. Pulse Derating Curve

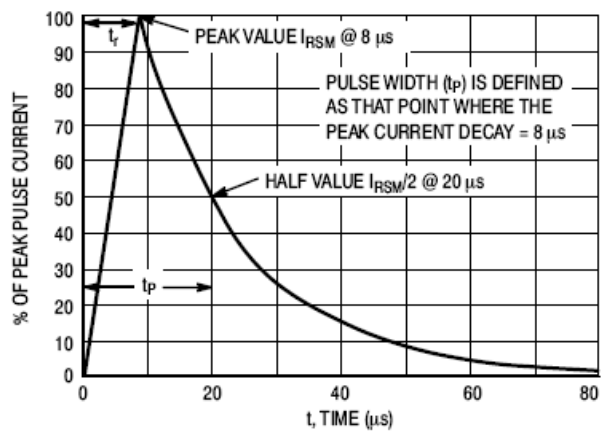

Figure 6. $8 \times 20 \mu\text{s}$ Pulse Waveform



Micro Commercial Components

Ordering Information :

Device	Packing
Part Number-TP	Tape&Reel: 3Kpcs/Reel

Note : Adding "-HF" suffix for halogen free, eg. Part Number-TP-HF

IMPORTANT NOTICE

Micro Commercial Components Corp. reserves the right to make changes without further notice to any product herein to make corrections, modifications , enhancements , improvements , or other changes . **Micro Commercial Components Corp .** does not assume any liability arising out of the application or use of any product described herein; neither does it convey any license under its patent rights ,nor the rights of others . The user of products in such applications shall assume all risks of such use and will agree to hold **Micro Commercial Components Corp .** and all the companies whose products are represented on our website, harmless against all damages.

LIFE SUPPORT

MCC's products are not authorized for use as critical components in life support devices or systems without the express written approval of Micro Commercial Components Corporation.

CUSTOMER AWARENESS

Counterfeiting of semiconductor parts is a growing problem in the industry. Micro Commercial Components (MCC) is taking strong measures to protect ourselves and our customers from the proliferation of counterfeit parts. MCC strongly encourages customers to purchase MCC parts either directly from MCC or from Authorized MCC Distributors who are listed by country on our web page cited below. Products customers buy either from MCC directly or from Authorized MCC Distributors are genuine parts, have full traceability, meet MCC's quality standards for handling and storage. **MCC will not provide any warranty coverage or other assistance for parts bought from Unauthorized Sources.** MCC is committed to combat this global problem and encourage our customers to do their part in stopping this practice by buying direct or from authorized distributors.



Компания «ЭлектроПласт» предлагает заключение долгосрочных отношений при поставках импортных электронных компонентов на взаимовыгодных условиях!

Наши преимущества:

- Оперативные поставки широкого спектра электронных компонентов отечественного и импортного производства напрямую от производителей и с крупнейших мировых складов;
- Поставка более 17-ти миллионов наименований электронных компонентов;
- Поставка сложных, дефицитных, либо снятых с производства позиций;
- Оперативные сроки поставки под заказ (от 5 рабочих дней);
- Экспресс доставка в любую точку России;
- Техническая поддержка проекта, помощь в подборе аналогов, поставка прототипов;
- Система менеджмента качества сертифицирована по Международному стандарту ISO 9001;
- Лицензия ФСБ на осуществление работ с использованием сведений, составляющих государственную тайну;
- Поставка специализированных компонентов (Xilinx, Altera, Analog Devices, Intersil, Interpoint, Microsemi, Aeroflex, Peregrine, Syfer, Eurofarad, Texas Instrument, Miteq, Cobham, E2V, MA-COM, Hittite, Mini-Circuits, General Dynamics и др.);

Помимо этого, одним из направлений компании «ЭлектроПласт» является направление «Источники питания». Мы предлагаем Вам помощь Конструкторского отдела:

- Подбор оптимального решения, техническое обоснование при выборе компонента;
- Подбор аналогов;
- Консультации по применению компонента;
- Поставка образцов и прототипов;
- Техническая поддержка проекта;
- Защита от снятия компонента с производства.



Как с нами связаться

Телефон: 8 (812) 309 58 32 (многоканальный)

Факс: 8 (812) 320-02-42

Электронная почта: org@eplast1.ru

Адрес: 198099, г. Санкт-Петербург, ул. Калинина, дом 2, корпус 4, литера А.