

[click here to see hardware and mounting options](#)

Type 500C 95 °C Long Life, Screw Terminal, Aluminum

Long Life, High Capacitance Screw Terminal Type



Type 500C capacitors are designed for mainframe computers and other long life UPS and power supply filter applications. They deliver nearly as much capacitance as the Type DCMC capacitors, but with two times the life expectancy. They are an excellent choice for high ripple applications. The extended cathode foil of the 500C assures cool operation with heat flow from the capacitor element to the can.

Highlights

- Long-life, High-Capacitance
- Better for Power-supply and UPS systems
- Thermal-Pak™ extended cathode construction

Specifications

| Temperature Range | -40 °C to +95 °C | | | | | | | | | | | | | | | | | | | | | | | | | | | | | | | | | | | | | | | | | | | | | | | | | | | | | | | | | | | | | | | | | | | | | | | | | | | | | | | | | | | | | | | | | | | | | | | | | | | | | | | | | | | | | | | | | | |
|--------------------------------------|--|--------------|---------------|---------------|--------------|--------------|------------------------|------|------|------|------|-----------|--------------|--------------|---------------|---------------|--------------|--------------|------------------------|--------------------------------------|--|--|--|--|--|--|--|---------------------|------|------|------|------|------|------|------|---------------------|------|------|------|------|------|------|------|---------------------|------|------|------|------|------|------|------|----------------------------------|--|--|--|--|--|--|--|---------------------|------|------|------|------|------|------|------|---------------------|------|------|------|------|------|------|------|---------------------|------|------|------|------|------|------|------|----------------------------------|--|--|--|--|--|--|--|---------------------|------|------|------|------|------|------|------|---------------------|------|------|------|------|------|------|------|---------------------|------|------|------|------|------|------|------|
| Rated Voltage Range | 6.3 Vdc to 550 Vdc | | | | | | | | | | | | | | | | | | | | | | | | | | | | | | | | | | | | | | | | | | | | | | | | | | | | | | | | | | | | | | | | | | | | | | | | | | | | | | | | | | | | | | | | | | | | | | | | | | | | | | | | | | | | | | | | | | |
| Capacitance Range | 100 µF to 2.6 F | | | | | | | | | | | | | | | | | | | | | | | | | | | | | | | | | | | | | | | | | | | | | | | | | | | | | | | | | | | | | | | | | | | | | | | | | | | | | | | | | | | | | | | | | | | | | | | | | | | | | | | | | | | | | | | | | | |
| Capacitance Tolerance | -10% +75% ≤ 100 Vdc -10% +50% ≥ 160 Vdc | | | | | | | | | | | | | | | | | | | | | | | | | | | | | | | | | | | | | | | | | | | | | | | | | | | | | | | | | | | | | | | | | | | | | | | | | | | | | | | | | | | | | | | | | | | | | | | | | | | | | | | | | | | | | | | | | | |
| Leakage Current | ≤ 3 √CV µA, 4 mA max, 5 minutes | | | | | | | | | | | | | | | | | | | | | | | | | | | | | | | | | | | | | | | | | | | | | | | | | | | | | | | | | | | | | | | | | | | | | | | | | | | | | | | | | | | | | | | | | | | | | | | | | | | | | | | | | | | | | | | | | | |
| Ripple Current Multipliers | <p>Ambient Temperature</p> <table border="1"> <tr> <td>45 °C</td> <td>55 °C</td> <td>65 °C</td> <td>75 °C</td> <td>85 °C</td> </tr> <tr> <td>2.00</td> <td>1.82</td> <td>1.59</td> <td>1.33</td> <td>1.00</td> </tr> </table> <table border="1"> <thead> <tr> <th>Frequency</th> <th>50 Hz</th> <th>60 Hz</th> <th>120 Hz</th> <th>360 Hz</th> <th>1 kHz</th> <th>5 kHz</th> <th>10 kHz & up</th> </tr> </thead> <tbody> <tr> <td>1 3/8" & 1 3/4" Diameters</td> <td></td> <td></td> <td></td> <td></td> <td></td> <td></td> <td></td> </tr> <tr> <td>6.3 to 160 V</td> <td>0.91</td> <td>0.93</td> <td>1.00</td> <td>1.06</td> <td>1.08</td> <td>1.10</td> <td>1.10</td> </tr> <tr> <td>200 to 350 V</td> <td>0.76</td> <td>0.81</td> <td>1.00</td> <td>1.24</td> <td>1.36</td> <td>1.43</td> <td>1.44</td> </tr> <tr> <td>400 to 500 V</td> <td>0.76</td> <td>0.81</td> <td>1.00</td> <td>1.24</td> <td>1.37</td> <td>1.44</td> <td>1.45</td> </tr> <tr> <td>2" & 2 1/2" Diameters</td> <td></td> <td></td> <td></td> <td></td> <td></td> <td></td> <td></td> </tr> <tr> <td>6.3 to 160 V</td> <td>0.93</td> <td>0.95</td> <td>1.00</td> <td>1.04</td> <td>1.06</td> <td>1.06</td> <td>1.07</td> </tr> <tr> <td>200 to 350 V</td> <td>0.78</td> <td>0.83</td> <td>1.00</td> <td>1.20</td> <td>1.29</td> <td>1.34</td> <td>1.35</td> </tr> <tr> <td>400 to 550 V</td> <td>0.77</td> <td>0.82</td> <td>1.00</td> <td>1.22</td> <td>1.33</td> <td>1.39</td> <td>1.40</td> </tr> <tr> <td>3" & 3 1/2" Diameters</td> <td></td> <td></td> <td></td> <td></td> <td></td> <td></td> <td></td> </tr> <tr> <td>6.3 to 160 V</td> <td>0.95</td> <td>0.97</td> <td>1.00</td> <td>1.03</td> <td>1.04</td> <td>1.04</td> <td>1.04</td> </tr> <tr> <td>200 to 350 V</td> <td>0.84</td> <td>0.88</td> <td>1.00</td> <td>1.12</td> <td>1.17</td> <td>1.20</td> <td>1.20</td> </tr> <tr> <td>400 to 550 V</td> <td>0.79</td> <td>0.84</td> <td>1.00</td> <td>1.18</td> <td>1.26</td> <td>1.31</td> <td>1.32</td> </tr> </tbody> </table> | 45 °C | 55 °C | 65 °C | 75 °C | 85 °C | 2.00 | 1.82 | 1.59 | 1.33 | 1.00 | Frequency | 50 Hz | 60 Hz | 120 Hz | 360 Hz | 1 kHz | 5 kHz | 10 kHz & up | 1 3/8" & 1 3/4" Diameters | | | | | | | | 6.3 to 160 V | 0.91 | 0.93 | 1.00 | 1.06 | 1.08 | 1.10 | 1.10 | 200 to 350 V | 0.76 | 0.81 | 1.00 | 1.24 | 1.36 | 1.43 | 1.44 | 400 to 500 V | 0.76 | 0.81 | 1.00 | 1.24 | 1.37 | 1.44 | 1.45 | 2" & 2 1/2" Diameters | | | | | | | | 6.3 to 160 V | 0.93 | 0.95 | 1.00 | 1.04 | 1.06 | 1.06 | 1.07 | 200 to 350 V | 0.78 | 0.83 | 1.00 | 1.20 | 1.29 | 1.34 | 1.35 | 400 to 550 V | 0.77 | 0.82 | 1.00 | 1.22 | 1.33 | 1.39 | 1.40 | 3" & 3 1/2" Diameters | | | | | | | | 6.3 to 160 V | 0.95 | 0.97 | 1.00 | 1.03 | 1.04 | 1.04 | 1.04 | 200 to 350 V | 0.84 | 0.88 | 1.00 | 1.12 | 1.17 | 1.20 | 1.20 | 400 to 550 V | 0.79 | 0.84 | 1.00 | 1.18 | 1.26 | 1.31 | 1.32 |
| 45 °C | 55 °C | 65 °C | 75 °C | 85 °C | | | | | | | | | | | | | | | | | | | | | | | | | | | | | | | | | | | | | | | | | | | | | | | | | | | | | | | | | | | | | | | | | | | | | | | | | | | | | | | | | | | | | | | | | | | | | | | | | | | | | | | | | | | | | | | |
| 2.00 | 1.82 | 1.59 | 1.33 | 1.00 | | | | | | | | | | | | | | | | | | | | | | | | | | | | | | | | | | | | | | | | | | | | | | | | | | | | | | | | | | | | | | | | | | | | | | | | | | | | | | | | | | | | | | | | | | | | | | | | | | | | | | | | | | | | | | | |
| Frequency | 50 Hz | 60 Hz | 120 Hz | 360 Hz | 1 kHz | 5 kHz | 10 kHz & up | | | | | | | | | | | | | | | | | | | | | | | | | | | | | | | | | | | | | | | | | | | | | | | | | | | | | | | | | | | | | | | | | | | | | | | | | | | | | | | | | | | | | | | | | | | | | | | | | | | | | | | | | | | | |
| 1 3/8" & 1 3/4" Diameters | | | | | | | | | | | | | | | | | | | | | | | | | | | | | | | | | | | | | | | | | | | | | | | | | | | | | | | | | | | | | | | | | | | | | | | | | | | | | | | | | | | | | | | | | | | | | | | | | | | | | | | | | | | | | | | | | | | |
| 6.3 to 160 V | 0.91 | 0.93 | 1.00 | 1.06 | 1.08 | 1.10 | 1.10 | | | | | | | | | | | | | | | | | | | | | | | | | | | | | | | | | | | | | | | | | | | | | | | | | | | | | | | | | | | | | | | | | | | | | | | | | | | | | | | | | | | | | | | | | | | | | | | | | | | | | | | | | | | | |
| 200 to 350 V | 0.76 | 0.81 | 1.00 | 1.24 | 1.36 | 1.43 | 1.44 | | | | | | | | | | | | | | | | | | | | | | | | | | | | | | | | | | | | | | | | | | | | | | | | | | | | | | | | | | | | | | | | | | | | | | | | | | | | | | | | | | | | | | | | | | | | | | | | | | | | | | | | | | | | |
| 400 to 500 V | 0.76 | 0.81 | 1.00 | 1.24 | 1.37 | 1.44 | 1.45 | | | | | | | | | | | | | | | | | | | | | | | | | | | | | | | | | | | | | | | | | | | | | | | | | | | | | | | | | | | | | | | | | | | | | | | | | | | | | | | | | | | | | | | | | | | | | | | | | | | | | | | | | | | | |
| 2" & 2 1/2" Diameters | | | | | | | | | | | | | | | | | | | | | | | | | | | | | | | | | | | | | | | | | | | | | | | | | | | | | | | | | | | | | | | | | | | | | | | | | | | | | | | | | | | | | | | | | | | | | | | | | | | | | | | | | | | | | | | | | | | |
| 6.3 to 160 V | 0.93 | 0.95 | 1.00 | 1.04 | 1.06 | 1.06 | 1.07 | | | | | | | | | | | | | | | | | | | | | | | | | | | | | | | | | | | | | | | | | | | | | | | | | | | | | | | | | | | | | | | | | | | | | | | | | | | | | | | | | | | | | | | | | | | | | | | | | | | | | | | | | | | | |
| 200 to 350 V | 0.78 | 0.83 | 1.00 | 1.20 | 1.29 | 1.34 | 1.35 | | | | | | | | | | | | | | | | | | | | | | | | | | | | | | | | | | | | | | | | | | | | | | | | | | | | | | | | | | | | | | | | | | | | | | | | | | | | | | | | | | | | | | | | | | | | | | | | | | | | | | | | | | | | |
| 400 to 550 V | 0.77 | 0.82 | 1.00 | 1.22 | 1.33 | 1.39 | 1.40 | | | | | | | | | | | | | | | | | | | | | | | | | | | | | | | | | | | | | | | | | | | | | | | | | | | | | | | | | | | | | | | | | | | | | | | | | | | | | | | | | | | | | | | | | | | | | | | | | | | | | | | | | | | | |
| 3" & 3 1/2" Diameters | | | | | | | | | | | | | | | | | | | | | | | | | | | | | | | | | | | | | | | | | | | | | | | | | | | | | | | | | | | | | | | | | | | | | | | | | | | | | | | | | | | | | | | | | | | | | | | | | | | | | | | | | | | | | | | | | | | |
| 6.3 to 160 V | 0.95 | 0.97 | 1.00 | 1.03 | 1.04 | 1.04 | 1.04 | | | | | | | | | | | | | | | | | | | | | | | | | | | | | | | | | | | | | | | | | | | | | | | | | | | | | | | | | | | | | | | | | | | | | | | | | | | | | | | | | | | | | | | | | | | | | | | | | | | | | | | | | | | | |
| 200 to 350 V | 0.84 | 0.88 | 1.00 | 1.12 | 1.17 | 1.20 | 1.20 | | | | | | | | | | | | | | | | | | | | | | | | | | | | | | | | | | | | | | | | | | | | | | | | | | | | | | | | | | | | | | | | | | | | | | | | | | | | | | | | | | | | | | | | | | | | | | | | | | | | | | | | | | | | |
| 400 to 550 V | 0.79 | 0.84 | 1.00 | 1.18 | 1.26 | 1.31 | 1.32 | | | | | | | | | | | | | | | | | | | | | | | | | | | | | | | | | | | | | | | | | | | | | | | | | | | | | | | | | | | | | | | | | | | | | | | | | | | | | | | | | | | | | | | | | | | | | | | | | | | | | | | | | | | | |
| Low Temperature Characteristics | Impedance ratio: $Z_{-20°C} / Z_{+25°C}$ ≤ 20 (6.3–10 Vdc) ≤ 8 (16–50 Vdc) ≤ 4 (63–100 Vdc) ≤ 3 (150–550 Vdc) | | | | | | | | | | | | | | | | | | | | | | | | | | | | | | | | | | | | | | | | | | | | | | | | | | | | | | | | | | | | | | | | | | | | | | | | | | | | | | | | | | | | | | | | | | | | | | | | | | | | | | | | | | | | | | | | | | |
| Endurance Life Test | 5000 h at full load at 85 °C Δ Capacitance ±20% ESR 200% of limit DCL 100% of limit | | | | | | | | | | | | | | | | | | | | | | | | | | | | | | | | | | | | | | | | | | | | | | | | | | | | | | | | | | | | | | | | | | | | | | | | | | | | | | | | | | | | | | | | | | | | | | | | | | | | | | | | | | | | | | | | | | |
| Shelf Life Test | 500 h at 95 °C Capacitance 100% of limit ESR 100% of limit DCL 100% of limit | | | | | | | | | | | | | | | | | | | | | | | | | | | | | | | | | | | | | | | | | | | | | | | | | | | | | | | | | | | | | | | | | | | | | | | | | | | | | | | | | | | | | | | | | | | | | | | | | | | | | | | | | | | | | | | | | | |
| Vibration | 10 to 55 Hz, 0.06" and 10 g max, 1.5 h each of 2 axes | | | | | | | | | | | | | | | | | | | | | | | | | | | | | | | | | | | | | | | | | | | | | | | | | | | | | | | | | | | | | | | | | | | | | | | | | | | | | | | | | | | | | | | | | | | | | | | | | | | | | | | | | | | | | | | | | | |

RoHS Compliant

Type 500C 95 °C Long Life, Screw Terminal, Aluminum

Long Life, High Capacitance Screw Terminal Type

Part Numbering System

| | | | | | | | |
|-------------|---|--|--|------------------|--------------------------------------|---|--|
| 500C | 492 | T | 200 | CB | 2 | B | S |
| | | | | | | | |
| Type | Capacitance | Tolerance | Voltage | Case Code | Insulation | Terminal | Can Style |
| | 100 = 10 µF 101 = 100 µF 492 = 4900 µF 433 = 43,000 µF | M = ±20% U = -10%+75% T = -10%+50% | 6R3 = 6.3 Vdc 063 = 63 Vdc 200 = 200 Vdc | | 0 = None 1 = Polyester 2 = PVC | A = Low Post B = High Post D = High Current, Low Post E = High Current, High Post F or M = M5 Post G = M6 Low Post H = M6 High Post | Blank = Standard Can S = Stud Bottom P = Stud with Thermal Pad |

Standard insulation is 0.008-in PVC sleeve with 0.01-in polypropylene end disk.
Polyester insulation is not available for 3.5 inch diameter units.

Outline Drawing

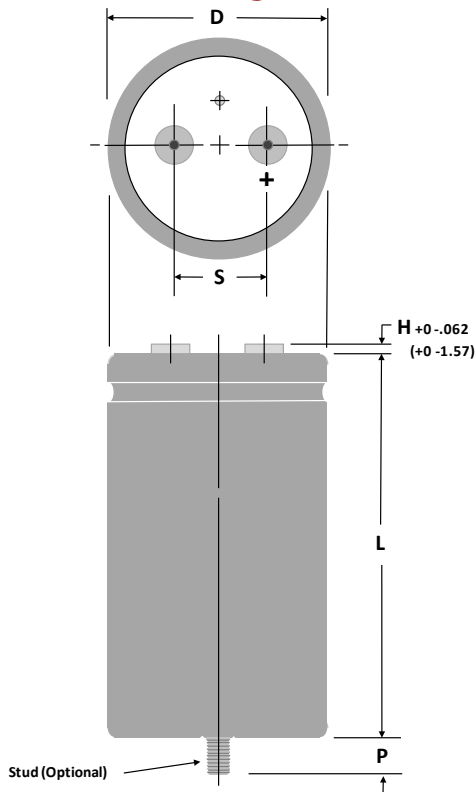

Stud Dimensions

| Case | Stud | P ± 0.039" |
|-------|--------|---------------|
| Diam. | Thread | (±1.0 mm) |
| 1.375 | M8 | 0.470" (12.0) |
| 1.750 | M8 | 0.470" (12.0) |
| 2.000 | M12 | 0.630" (16.0) |
| 2.500 | M12 | 0.630" (16.0) |
| 3.000 | M12 | 0.630" (16.0) |
| 3.500 | M12 | 0.630" (16.0) |

NOTE: With the stud-mount feature, a thermally-conductive disk can be inserted in the bottom flush with the outer insulating sleeve. This reduces the thermal resistance through the can bottom by 0.3 °C/W. Can Style P.

Terminal Dimensions

| Terminal Style | For Case Diameters | Code | Post Diameter | | H max | | Thread | min Full Thread | | Torque | |
|--------------------|--------------------|------|---------------|------|-------|-----|--------|-----------------|------|--------|------|
| | | | in | mm | in | mm | | in | mm | in-lb | N-m |
| Low Post | 1 3/8 to 3 | A | 0.314 | 8.0 | 0.094 | 2.4 | 10-32 | 0.218 | 5.5 | 25 | 2.82 |
| High Post | 1 3/8 to 3 | B | 0.314 | 8.0 | 0.281 | 7.1 | 10-32 | 0.375 | 9.5 | 25 | 2.82 |
| High Current, Low | 2 1/2 to 3 1/2 | D | 0.684 | 17.4 | 0.125 | 3.2 | 1/4-28 | 0.344 | 8.7 | 50 | 5.65 |
| High Current, High | 2 1/2 to 3 1/2 | E | 0.684 | 17.4 | 0.281 | 7.1 | 1/4-28 | 0.469 | 11.9 | 60 | 6.78 |
| M5 Post, Small | 1 3/8 to 2 | M | 0.314 | 8.0 | 0.281 | 7.1 | M5 | 0.375 | 9.5 | 25 | 2.82 |
| M5 Post | 2 1/2 & 3 | F | 0.512 | 13.0 | 0.230 | 5.8 | M5 | 0.344 | 8.7 | 25 | 2.82 |
| M6 Low Post | 2 1/2 to 3 1/2 | G | 0.684 | 17.4 | 0.125 | 3.2 | M6 | 0.344 | 8.7 | 50 | 5.65 |
| M6 High Post | 2 1/2 to 3 1/2 | H | 0.684 | 17.4 | 0.281 | 7.1 | M6 | 0.469 | 11.9 | 60 | 6.78 |

NOTE: Only high post and M5 post terminals are available at 550 Vdc as they meet the required creepage distance.

Type 500C 95 °C Long Life, Screw Terminal, Aluminum

Long Life, High Capacitance Screw Terminal Type

Uninsulated Case Dimensions

For insulated case, add 0.024"(0.610 mm) to "D" and 0.030"(0.762 mm) to length.

| Case Code | Diam. (D) | | Length (L) | | Terminals (S) | | Typical Weight | |
|-----------|--------------|---------|--------------|----------|---------------|---------|----------------|------|
| | ±.031 Inches | ±.78 mm | ±.062 Inches | ±1.57 mm | ±0.015 Inches | ±.38 mm | oz | g |
| AK | 1.375 | 34.93 | 1.625 | 41.28 | 0.50 | 12.70 | 1.9 | 54 |
| AA | 1.375 | 34.93 | 2.125 | 53.98 | 0.50 | 12.70 | 2.0 | 57 |
| AH | 1.375 | 34.93 | 2.625 | 66.68 | 0.50 | 12.70 | 2.7 | 77 |
| AB | 1.375 | 34.93 | 3.125 | 79.38 | 0.50 | 12.70 | 3.3 | 94 |
| AJ | 1.375 | 34.93 | 3.625 | 92.08 | 0.50 | 12.70 | 3.8 | 108 |
| AC | 1.375 | 34.93 | 4.125 | 104.78 | 0.50 | 12.70 | 4.4 | 125 |
| AD | 1.375 | 34.93 | 4.625 | 117.48 | 0.50 | 12.70 | 5.1 | 145 |
| AE | 1.375 | 34.93 | 5.125 | 130.18 | 0.50 | 12.70 | 6.8 | 193 |
| AF | 1.375 | 34.93 | 5.625 | 142.88 | 0.50 | 12.70 | 8.1 | 230 |
| EA | 1.750 | 44.45 | 2.125 | 53.98 | 0.75 | 19.05 | 2.7 | 76 |
| EH | 1.750 | 44.45 | 2.625 | 66.68 | 0.75 | 19.05 | 3.8 | 108 |
| EB | 1.750 | 44.45 | 3.125 | 79.38 | 0.75 | 19.05 | 5.1 | 145 |
| EJ | 1.750 | 44.45 | 3.625 | 92.08 | 0.75 | 19.05 | 6.8 | 193 |
| EC | 1.750 | 44.45 | 4.125 | 104.78 | 0.75 | 19.05 | 8.1 | 230 |
| ED | 1.750 | 44.45 | 4.625 | 117.48 | 0.75 | 19.05 | 9.0 | 255 |
| EE | 1.750 | 44.45 | 5.125 | 130.18 | 0.75 | 19.05 | 9.5 | 269 |
| EF | 1.750 | 44.45 | 5.625 | 142.88 | 0.75 | 19.05 | 10.5 | 298 |
| BA | 2.000 | 50.80 | 2.125 | 53.98 | 0.88 | 22.23 | 5.4 | 153 |
| BH | 2.000 | 50.80 | 2.625 | 66.68 | 0.88 | 22.23 | 6.1 | 173 |
| BB | 2.000 | 50.80 | 3.125 | 79.38 | 0.88 | 22.23 | 6.8 | 193 |
| BJ | 2.000 | 50.80 | 3.625 | 92.08 | 0.88 | 22.23 | 8.2 | 232 |
| BC | 2.000 | 50.80 | 4.125 | 104.78 | 0.88 | 22.23 | 9.5 | 269 |
| BD | 2.000 | 50.80 | 4.625 | 117.48 | 0.88 | 22.23 | 10.3 | 292 |
| BE | 2.000 | 50.80 | 5.125 | 130.18 | 0.88 | 22.23 | 10.7 | 303 |
| BF | 2.000 | 50.80 | 5.625 | 142.88 | 0.88 | 22.23 | 13.0 | 369 |
| CH | 2.500 | 63.50 | 2.625 | 66.68 | 1.13 | 28.58 | 9.2 | 261 |
| CB | 2.500 | 63.50 | 3.125 | 79.38 | 1.13 | 28.58 | 10.4 | 295 |
| CJ | 2.500 | 63.50 | 3.625 | 92.08 | 1.13 | 28.58 | 12.7 | 361 |
| CC | 2.500 | 63.50 | 4.125 | 104.78 | 1.13 | 28.58 | 15.0 | 425 |
| CD | 2.500 | 63.50 | 4.625 | 117.48 | 1.13 | 28.58 | 17.2 | 488 |
| CE | 2.500 | 63.50 | 5.125 | 130.18 | 1.13 | 28.58 | 19.3 | 547 |
| CF | 2.500 | 63.50 | 5.625 | 142.88 | 1.13 | 28.58 | 21.4 | 607 |
| DB | 3.000 | 76.20 | 3.125 | 79.38 | 1.25 | 31.75 | 16.7 | 473 |
| DJ | 3.000 | 76.20 | 3.625 | 92.08 | 1.25 | 31.75 | 20.0 | 567 |
| DC | 3.000 | 76.20 | 4.125 | 104.78 | 1.25 | 31.75 | 22.2 | 629 |
| DD | 3.000 | 76.20 | 4.625 | 117.48 | 1.25 | 31.75 | 25.5 | 723 |
| DE | 3.000 | 76.20 | 5.125 | 130.18 | 1.25 | 31.75 | 30.0 | 850 |
| DF | 3.000 | 76.20 | 5.625 | 142.88 | 1.25 | 31.75 | 31.9 | 904 |
| DP | 3.000 | 76.20 | 5.875 | 149.23 | 1.25 | 31.75 | 32.8 | 931 |
| DN | 3.000 | 76.20 | 7.625 | 193.68 | 1.25 | 31.75 | 39.5 | 1119 |
| DG | 3.000 | 76.20 | 8.625 | 219.08 | 1.25 | 31.75 | 43.3 | 1227 |
| FC | 3.500 | 88.90 | 4.125 | 104.78 | 1.25 | 31.75 | 30.0 | 850 |
| FD | 3.500 | 88.90 | 4.625 | 117.48 | 1.25 | 31.75 | 34.4 | 976 |
| FE | 3.500 | 88.90 | 5.125 | 130.18 | 1.25 | 31.75 | 40.5 | 1148 |
| FF | 3.500 | 88.90 | 5.625 | 142.88 | 1.25 | 31.75 | 43.1 | 1221 |
| FP | 3.500 | 88.90 | 5.875 | 149.23 | 1.25 | 31.75 | 44.3 | 1257 |
| FN | 3.500 | 88.90 | 7.625 | 193.68 | 1.25 | 31.75 | 53.3 | 1512 |
| FG | 3.500 | 88.90 | 8.625 | 219.08 | 1.25 | 31.75 | 58.5 | 1658 |

Type 500C 95 °C Long Life, Screw Terminal, Aluminum

Long Life, High Capacitance Screw Terminal Type Ratings

| Cap. (µF) | Catalog Part Number | ESR Max. @ 25 °C 120 Hz (mΩ) | Ripple Max. @ 85°C 120 Hz (A) | Nominal Size D x L (inches) |
|------------------------------|---------------------|------------------------------|-------------------------------|-----------------------------|
| 6.3 Vdc (8 Vdc Surge) | | | | |
| 27000 | 500C273U6R3AK2B | 46.9 | 4.70 | 1 3/8 x 1 5/8 |
| 55000 | 500C553U6R3AA2B | 26.5 | 6.90 | 1 3/8 x 2 1/8 |
| 66000 | 500C663U6R3AH2B | 18.8 | 8.90 | 1 3/8 x 2 5/8 |
| 87000 | 500C873U6R3AB2B | 14.7 | 10.70 | 1 3/8 x 3 1/8 |
| 96000 | 500C963U6R3EA2B | 18.8 | 9.60 | 1 3/4 x 2 1/8 |
| 110000 | 500C114U6R3AJ2B | 12.8 | 12.10 | 1 3/8 x 3 5/8 |
| 120000 | 500C124U6R3EH2B | 14.3 | 11.80 | 1 3/4 x 2 5/8 |
| 120000 | 500C124U6R3BA2B | 14.2 | 12.00 | 2 x 2 1/8 |
| 130000 | 500C134U6R3AC2B | 11.0 | 13.70 | 1 3/8 x 4 1/8 |
| 140000 | 500C144U6R3BH2B | 9.9 | 15.50 | 2 x 2 5/8 |
| 150000 | 500C154U6R3AD2B | 9.8 | 15.20 | 1 3/8 x 4 5/8 |
| 160000 | 500C164U6R3EB2B | 11.0 | 14.30 | 1 3/4 x 3 1/8 |
| 170000 | 500C174U6R3AE2B | 8.9 | 16.50 | 1 3/8 x 5 1/8 |
| 190000 | 500C194U6R3AF2B | 8.3 | 17.80 | 1 3/8 x 5 5/8 |
| 190000 | 500C194U6R3EJ2B | 9.1 | 16.60 | 1 3/4 x 3 5/8 |
| 200000 | 500C204U6R3BB2B | 7.8 | 18.40 | 2 x 3 1/8 |
| 230000 | 500C234U6R3EC2B | 7.9 | 18.70 | 1 3/4 x 4 1/8 |
| 250000 | 500C254U6R3BJ2B | 6.5 | 21.40 | 2 x 3 5/8 |
| 250000 | 500C254U6R3CH2B | 6.9 | 21.20 | 2 1/2 x 2 5/8 |
| 270000 | 500C274U6R3ED2B | 7.0 | 20.60 | 1 3/4 x 4 5/8 |
| 300000 | 500C304U6R3BC2B | 5.6 | 24.10 | 2 x 4 1/8 |
| 310000 | 500C314U6R3EE2B | 6.4 | 22.40 | 1 3/4 x 5 1/8 |
| 340000 | 500C344U6R3CB2B | 5.3 | 25.80 | 2 1/2 x 3 1/8 |
| 350000 | 500C354U6R3EF2B | 6.0 | 24.00 | 1 3/4 x 5 5/8 |
| 360000 | 500C364U6R3BD2B | 5.0 | 26.60 | 2 x 4 5/8 |
| 410000 | 500C414U6R3BE2B | 4.5 | 28.80 | 2 x 5 1/8 |
| 420000 | 500C424U6R3CJ2B | 4.3 | 29.90 | 2 1/2 x 3 5/8 |
| 450000 | 500C454U6R3BF2D | 4.2 | 30.90 | 2 x 5 5/8 |
| 500000 | 500C504U6R3DB2D | 4.1 | 32.90 | 3 x 3 1/8 |
| 510000 | 500C514U6R3CC2D | 3.8 | 33.40 | 2 1/2 x 4 1/8 |
| 580000 | 500C584U6R3CD2D | 3.4 | 36.80 | 2 1/2 x 4 5/8 |
| 620000 | 500C624U6R3DJ2D | 3.3 | 38.20 | 3 x 3 5/8 |
| 680000 | 500C684U6R3CE2D | 3.1 | 40.00 | 2 1/2 x 5 1/8 |
| 740000 | 500C744U6R3DC2D | 2.9 | 42.50 | 3 x 4 1/8 |
| 760000 | 500C764U6R3CF2D | 2.8 | 42.90 | 2 1/2 x 5 5/8 |
| 880000 | 500C884U6R3DD2D | 2.6 | 46.70 | 3 x 4 5/8 |
| 980000 | 500C984U6R3DE2D | 2.4 | 50.60 | 3 x 5 1/8 |
| 1100000 | 500C115U6R3DF2D | 2.4 | 51.30 | 3 x 5 5/8 |
| 1100000 | 500C115U6R3FC2D | 3.0 | 46.40 | 3 1/2 x 4 1/8 |
| 1100000 | 500C115U6R3FD2D | 2.6 | 51.00 | 3 1/2 x 4 5/8 |
| 1200000 | 500C125U6R3DP2D | 2.4 | 52.00 | 3 x 5 7/8 |
| 1400000 | 500C145U6R3FE2D | 2.4 | 55.40 | 3 1/2 x 5 1/8 |
| 1600000 | 500C165U6R3FF2D | 2.4 | 56.10 | 3 1/2 x 5 5/8 |

| Cap. (µF) | Catalog Part Number | ESR Max. @ 25 °C 120 Hz (mΩ) | Ripple Max. @ 85°C 120 Hz (A) | Nominal Size D x L (inches) |
|------------------------------|---------------------|------------------------------|-------------------------------|-----------------------------|
| 6.3 Vdc (8 Vdc Surge) | | | | |
| 1600000 | 500C165U6R3DN2D | 2.6 | 55.90 | 3 x 7 5/8 |
| 1700000 | 500C175U6R3FP2D | 2.4 | 57.00 | 3 1/2 x 5 7/8 |
| 1800000 | 500C185U6R3DG2D | 2.4 | 58.60 | 3 x 8 5/8 |
| 2300000 | 500C235U6R3FN2D | 2.4 | 61.70 | 3 1/2 x 7 5/8 |
| 2600000 | 500C265U6R3FG2D | 2.4 | 64.40 | 3 1/2 x 8 5/8 |
| 10 Vdc (12 Vdc Surge) | | | | |
| 22000 | 500C223U010AK2B | 46.9 | 4.70 | 1 3/8 x 1 5/8 |
| 39000 | 500C393U010AA2B | 26.5 | 6.90 | 1 3/8 x 2 1/8 |
| 52000 | 500C523U010AH2B | 20.1 | 8.60 | 1 3/8 x 2 5/8 |
| 70000 | 500C703U010AB2B | 15.5 | 10.50 | 1 3/8 x 3 1/8 |
| 71000 | 500C713U010EA2B | 18.8 | 9.60 | 1 3/4 x 2 1/8 |
| 87000 | 500C873U010AJ2B | 12.8 | 12.10 | 1 3/8 x 3 5/8 |
| 95000 | 500C953U010EH2B | 14.3 | 11.80 | 1 3/4 x 2 5/8 |
| 100000 | 500C104U010AC2B | 11.0 | 13.70 | 1 3/8 x 4 1/8 |
| 100000 | 500C104U010BA2B | 17.6 | 10.70 | 2 x 2 1/8 |
| 120000 | 500C124U010AD2B | 9.8 | 15.20 | 1 3/8 x 4 5/8 |
| 130000 | 500C134U010EB2B | 11.0 | 14.30 | 1 3/4 x 3 1/8 |
| 130000 | 500C134U010BH2B | 13.4 | 13.30 | 2 x 2 5/8 |
| 140000 | 500C144U010AE2B | 8.9 | 16.50 | 1 3/8 x 5 1/8 |
| 160000 | 500C164U010AF2B | 8.3 | 17.80 | 1 3/8 x 5 5/8 |
| 160000 | 500C164U010EJ2B | 9.1 | 16.60 | 1 3/4 x 3 5/8 |
| 160000 | 500C164U010BB2B | 10.5 | 16.00 | 2 x 3 1/8 |
| 190000 | 500C194U010EC2B | 7.9 | 18.70 | 1 3/4 x 4 1/8 |
| 200000 | 500C204U010BJ2B | 8.7 | 18.50 | 2 x 3 5/8 |
| 200000 | 500C204U010CH2B | 8.8 | 18.90 | 2 1/2 x 2 5/8 |
| 220000 | 500C224U010ED2B | 7.0 | 20.60 | 1 3/4 x 4 5/8 |
| 240000 | 500C244U010BC2B | 7.5 | 20.80 | 2 x 4 1/8 |
| 250000 | 500C254U010EE2B | 6.4 | 22.40 | 1 3/4 x 5 1/8 |
| 270000 | 500C274U010CB2B | 6.7 | 22.90 | 2 1/2 x 3 1/8 |
| 280000 | 500C284U010EF2B | 6.0 | 24.00 | 1 3/4 x 5 5/8 |
| 280000 | 500C284U010BD2B | 6.7 | 22.90 | 2 x 4 5/8 |
| 320000 | 500C324U010BE2B | 6.1 | 24.80 | 2 x 5 1/8 |
| 340000 | 500C344U010CJ2B | 5.5 | 26.50 | 2 1/2 x 3 5/8 |
| 360000 | 500C364U010BF2B | 5.7 | 26.50 | 2 x 5 5/8 |
| 400000 | 500C404U010DB2D | 4.1 | 32.90 | 3 x 3 1/8 |
| 410000 | 500C414U010CC2B | 4.8 | 29.60 | 2 1/2 x 4 1/8 |
| 480000 | 500C484U010CD2D | 4.3 | 32.60 | 2 1/2 x 4 5/8 |
| 500000 | 500C504U010DJ2D | 3.3 | 38.20 | 3 x 3 5/8 |
| 550000 | 500C554U010CE2D | 3.9 | 35.30 | 2 1/2 x 5 1/8 |
| 600000 | 500C604U010DC2D | 2.9 | 42.50 | 3 x 4 1/8 |
| 610000 | 500C614U010CF2D | 3.6 | 37.90 | 2 1/2 x 5 5/8 |
| 700000 | 500C704U010DD2D | 2.6 | 46.70 | 3 x 4 5/8 |
| 800000 | 500C804U010DE2D | 2.4 | 50.60 | 3 x 5 1/8 |

Type 500C 95 °C Long Life, Screw Terminal, Aluminum

Long Life, High Capacitance Screw Terminal Type

| Cap. (µF) | Catalog Part Number | ESR Max. @ 25 °C 120 Hz (mΩ) | Ripple Max. @ 85 °C 120 Hz (A) | Nominal Size D x L (inches) |
|------------------------------|---------------------|------------------------------|--------------------------------|-----------------------------|
| 830000 | 500C834U010FC2D | 2.9 | 47.30 | 3 1/2 x 4 1/8 |
| 870000 | 500C874U010DF2D | 2.3 | 53.00 | 3 x 5 5/8 |
| 930000 | 500C934U010DP2D | 2.3 | 53.30 | 3 x 5 7/8 |
| 970000 | 500C974U010FD2D | 2.8 | 49.60 | 3 1/2 x 4 5/8 |
| 1100000 | 500C115U010FE2D | 2.5 | 54.50 | 3 1/2 x 5 1/8 |
| 1200000 | 500C125U010FF2D | 2.2 | 59.00 | 3 1/2 x 5 5/8 |
| 1300000 | 500C135U010FP2D | 2.1 | 60.80 | 3 1/2 x 5 7/8 |
| 1300000 | 500C135U010DN2D | 2.1 | 60.10 | 3 x 7 5/8 |
| 1500000 | 500C155U010DG2D | 2.1 | 63.70 | 3 x 8 5/8 |
| 1700000 | 500C175U010FN2D | 1.8 | 73.40 | 3 1/2 x 7 5/8 |
| 2000000 | 500C205U010FG2D | 1.5 | 80.50 | 3 1/2 x 8 5/8 |
| 16 Vdc (20 Vdc Surge) | | | | |
| 15000 | 500C153U016AK2B | 46.9 | 4.7 | 1 3/8 x 1 5/8 |
| 27000 | 500C273U016AA2B | 26.5 | 6.9 | 1 3/8 x 2 1/8 |
| 36000 | 500C363U016AH2B | 20.1 | 8.6 | 1 3/8 x 2 5/8 |
| 48000 | 500C483U016AB2B | 15.5 | 10.5 | 1 3/8 x 3 1/8 |
| 49000 | 500C493U016EA2B | 18.8 | 9.6 | 1 3/4 x 2 1/8 |
| 61000 | 500C613U016AJ2B | 12.8 | 12.1 | 1 3/8 x 3 5/8 |
| 66000 | 500C663U016EH2B | 15.3 | 11.4 | 1 3/4 x 2 5/8 |
| 71000 | 500C713U016BA2B | 17.6 | 10.7 | 2 x 2 1/8 |
| 73000 | 500C733U016AC2B | 11.0 | 13.7 | 1 3/8 x 4 1/8 |
| 85000 | 500C853U016AD2B | 9.8 | 15.20 | 1 3/8 x 4 5/8 |
| 88000 | 500C883U016EB2B | 12.5 | 13.50 | 1 3/4 x 3 1/8 |
| 90000 | 500C903U016BH2B | 13.4 | 13.30 | 2 x 2 5/8 |
| 97000 | 500C973U016AE2B | 8.9 | 16.50 | 1 3/8 x 5 1/8 |
| 110000 | 500C114U016AF2B | 8.3 | 17.80 | 1 3/8 x 5 5/8 |
| 110000 | 500C114U016EJ2B | 10.9 | 15.20 | 1 3/4 x 3 5/8 |
| 110000 | 500C114U016BB2B | 10.5 | 16.00 | 2 x 3 1/8 |
| 130000 | 500C134U016EC2B | 9.7 | 16.90 | 1 3/4 x 4 1/8 |
| 140000 | 500C144U016BJ2B | 8.7 | 18.50 | 2 x 3 5/8 |
| 140000 | 500C144U016CH2B | 8.8 | 18.90 | 2 1/2 x 2 5/8 |
| 150000 | 500C154U016ED2B | 8.8 | 18.50 | 1 3/4 x 4 5/8 |
| 170000 | 500C174U016BC2B | 7.5 | 20.80 | 2 x 4 1/8 |
| 180000 | 500C184U016EE2B | 8.2 | 19.90 | 1 3/4 x 5 1/8 |
| 190000 | 500C194U016CB2B | 6.7 | 22.90 | 2 1/2 x 3 1/8 |
| 200000 | 500C204U016EF2B | 7.8 | 21.10 | 1 3/4 x 5 5/8 |
| 200000 | 500C204U016BD2B | 6.7 | 22.90 | 2 x 4 5/8 |
| 220000 | 500C224U016BE2B | 6.1 | 24.80 | 2 x 5 1/8 |
| 230000 | 500C234U016CJ2B | 5.5 | 26.50 | 2 1/2 x 3 5/8 |
| 250000 | 500C254U016BF2B | 5.7 | 26.50 | 2 x 5 5/8 |
| 280000 | 500C284U016CC2B | 5.0 | 29.20 | 2 1/2 x 4 1/8 |
| 280000 | 500C284U016DB2D | 4.2 | 32.40 | 3 x 3 1/8 |
| 320000 | 500C324U016CD2D | 4.6 | 31.40 | 2 1/2 x 4 5/8 |
| 350000 | 500C354U016DJ2D | 3.6 | 36.80 | 3 x 3 5/8 |

| Cap. (µF) | Catalog Part Number | ESR Max. @ 25 °C 120 Hz (mΩ) | Ripple Max. @ 85 °C 120 Hz (A) | Nominal Size D x L (inches) |
|------------------------------|---------------------|------------------------------|--------------------------------|-----------------------------|
| 370000 | 500C374U016CE2D | 4.4 | 33.40 | 2 1/2 x 5 1/8 |
| 420000 | 500C424U016CF2D | 4.2 | 35.20 | 2 1/2 x 5 5/8 |
| 420000 | 500C424U016DC2D | 3.3 | 40.20 | 3 x 4 1/8 |
| 490000 | 500C494U016DD2D | 3.1 | 42.80 | 3 x 4 5/8 |
| 550000 | 500C554U016DE2D | 2.8 | 46.20 | 3 x 5 1/8 |
| 600000 | 500C604U016FC2D | 2.9 | 47.30 | 3 1/2 x 4 1/8 |
| 610000 | 500C614U016DF2D | 2.8 | 48.10 | 3 x 5 5/8 |
| 640000 | 500C644U016DP2D | 2.8 | 48.80 | 3 x 5 7/8 |
| 700000 | 500C704U016FD2D | 2.8 | 49.70 | 3 1/2 x 4 5/8 |
| 800000 | 500C804U016FE2D | 2.5 | 54.40 | 3 1/2 x 5 1/8 |
| 870000 | 500C874U016FF2D | 2.4 | 56.70 | 3 1/2 x 5 5/8 |
| 870000 | 500C874U016DN2D | 2.6 | 54.10 | 3 x 7 5/8 |
| 920000 | 500C924U016FP2D | 2.4 | 57.30 | 3 1/2 x 5 7/8 |
| 1000000 | 500C105U016DG2D | 2.6 | 57.10 | 3 x 8 5/8 |
| 1300000 | 500C135U016FN2D | 2.3 | 63.10 | 3 1/2 x 7 5/8 |
| 1500000 | 500C155U016FG2D | 2.3 | 66.40 | 3 1/2 x 8 5/8 |
| 25 Vdc (30 Vdc Surge) | | | | |
| 11000 | 500C113U025AK2B | 37.1 | 5.30 | 1 3/8 x 1 5/8 |
| 18000 | 500C183U025AA2B | 23.6 | 7.40 | 1 3/8 x 2 1/8 |
| 26000 | 500C263U025AH2B | 16.9 | 9.40 | 1 3/8 x 2 5/8 |
| 33000 | 500C333U025EA2B | 21.8 | 8.90 | 1 3/4 x 2 1/8 |
| 34000 | 500C343U025AB2B | 17.1 | 10.00 | 1 3/8 x 3 1/8 |
| 39000 | 500C393U025EH2B | 19.4 | 10.20 | 1 3/4 x 2 5/8 |
| 43000 | 500C433U025AJ2B | 17.7 | 10.30 | 1 3/8 x 3 5/8 |
| 47000 | 500C473U025BA2B | 21.8 | 9.70 | 2 x 2 1/8 |
| 51000 | 500C513U025AC2B | 16.3 | 11.30 | 1 3/8 x 4 1/8 |
| 53000 | 500C533U025BH2B | 16.5 | 12.00 | 2 x 2 5/8 |
| 54000 | 500C543U025EB2B | 15.2 | 12.20 | 1 3/4 x 3 1/8 |
| 60000 | 500C603U025AD2B | 15.4 | 12.10 | 1 3/8 x 4 5/8 |
| 69000 | 500C693U025AE2B | 14.4 | 13.00 | 1 3/8 x 5 1/8 |
| 69000 | 500C693U025BB2B | 12.2 | 14.80 | 2 x 3 1/8 |
| 70000 | 500C703U025EJ2B | 12.8 | 14.10 | 1 3/4 x 3 5/8 |
| 77000 | 500C773U025AF2B | 13.4 | 14.00 | 1 3/8 x 5 5/8 |
| 82000 | 500C823U025CH2B | 9.5 | 18.10 | 2 1/2 x 2 5/8 |
| 86000 | 500C863U025EC2B | 11.2 | 15.70 | 1 3/4 x 4 1/8 |
| 89000 | 500C893U025BJ2B | 9.8 | 17.40 | 2 x 3 5/8 |
| 100000 | 500C104U025ED2B | 10.2 | 17.10 | 1 3/4 x 4 5/8 |
| 110000 | 500C114U025BC2B | 8.3 | 19.70 | 2 x 4 1/8 |
| 110000 | 500C114U025CB2B | 7.6 | 21.50 | 2 1/2 x 3 1/8 |
| 120000 | 500C124U025EE2B | 9.6 | 18.40 | 1 3/4 x 5 1/8 |
| 130000 | 500C134U025EF2B | 9.1 | 19.50 | 1 3/4 x 5 5/8 |
| 130000 | 500C134U025BD2B | 7.3 | 21.90 | 2 x 4 5/8 |
| 150000 | 500C154U025BE2B | 6.6 | 23.90 | 2 x 5 1/8 |
| 150000 | 500C154U025CJ2B | 6.4 | 24.60 | 2 1/2 x 3 5/8 |

Type 500C 95 °C Long Life, Screw Terminal, Aluminum

Long Life, High Capacitance Screw Terminal Type

| Cap. (µF) | Catalog Part Number | ESR Max. @ 25 °C 120 Hz (mΩ) | Ripple Max. @ 85 °C 120 Hz (A) | Nominal Size D x L (inches) |
|------------------------------|---------------------|------------------------------|--------------------------------|-----------------------------|
| 170000 | 500C174U025BF2B | 6.1 | 25.70 | 2 x 5 5/8 |
| 170000 | 500C174U025DB2B | 5.0 | 29.70 | 3 x 3 1/8 |
| 180000 | 500C184U025CC2B | 5.8 | 27.00 | 2 1/2 x 4 1/8 |
| 210000 | 500C214U025CD2B | 5.2 | 29.50 | 2 1/2 x 4 5/8 |
| 220000 | 500C224U025DJ2D | 4.3 | 31.10 | 3 x 3 5/8 |
| 250000 | 500C254U025CE2D | 5.0 | 33.60 | 2 1/2 x 5 1/8 |
| 270000 | 500C274U025DC2D | 3.9 | 36.90 | 3 x 4 1/8 |
| 280000 | 500C284U025CF2D | 4.6 | 33.70 | 2 1/2 x 5 5/8 |
| 320000 | 500C324U025DD2D | 3.5 | 40.00 | 3 x 4 5/8 |
| 370000 | 500C374U025DE2D | 3.3 | 42.70 | 3 x 5 1/8 |
| 390000 | 500C394U025FC2D | 3.8 | 40.90 | 3 1/2 x 4 1/8 |
| 420000 | 500C424U025DF2D | 3.2 | 44.90 | 3 x 5 5/8 |
| 440000 | 500C444U025DP2D | 3.1 | 46.50 | 3 x 5 7/8 |
| 460000 | 500C464U025FD2D | 3.5 | 44.40 | 3 1/2 x 4 5/8 |
| 530000 | 500C534U025FE2D | 3.2 | 47.40 | 3 1/2 x 5 1/8 |
| 600000 | 500C604U025FF2D | 3.1 | 50.20 | 3 1/2 x 5 5/8 |
| 610000 | 500C614U025DN2D | 3.1 | 50.20 | 3 x 7 5/8 |
| 630000 | 500C634U025FP2D | 2.9 | 51.80 | 3 1/2 x 5 7/8 |
| 710000 | 500C714U025DG2D | 3.0 | 52.80 | 3 x 8 5/8 |
| 870000 | 500C874U025FN2D | 3.0 | 55.60 | 3 1/2 x 7 5/8 |
| 1000000 | 500C105U025FG2D | 2.9 | 58.30 | 3 1/2 x 8 5/8 |
| 35 Vdc (40 Vdc Surge) | | | | |
| 6600 | 500C662U035AK2B | 41.7 | 5.00 | 1 3/8 x 1 5/8 |
| 11000 | 500C113U035AA2B | 26.7 | 6.90 | 1 3/8 x 2 1/8 |
| 16000 | 500C163U035AH2B | 19.5 | 8.70 | 1 3/8 x 2 5/8 |
| 20000 | 500C203U035EA2B | 22.3 | 8.80 | 1 3/4 x 2 1/8 |
| 21000 | 500C213U035AB2B | 19.4 | 9.30 | 1 3/8 x 3 1/8 |
| 24000 | 500C243U035EH2B | 19.2 | 10.20 | 1 3/4 x 2 5/8 |
| 26000 | 500C263U035AJ2B | 19.7 | 9.80 | 1 3/8 x 3 5/8 |
| 26000 | 500C263U035BA2B | 24.5 | 9.10 | 2 x 2 1/8 |
| 32000 | 500C323U035AC2B | 18.7 | 10.50 | 1 3/8 x 4 1/8 |
| 33000 | 500C333U035BH2B | 20.1 | 10.80 | 2 x 2 5/8 |
| 34000 | 500C343U035EB2B | 15.5 | 12.10 | 1 3/4 x 3 1/8 |
| 37000 | 500C373U035AD2B | 16.7 | 11.60 | 1 3/8 x 4 5/8 |
| 42000 | 500C423U035AE2B | 14.8 | 12.90 | 1 3/8 x 5 1/8 |
| 43000 | 500C433U035EJ2B | 13.2 | 13.80 | 1 3/4 x 3 5/8 |
| 43000 | 500C433U035BB2B | 15.9 | 13.00 | 2 x 3 1/8 |
| 48000 | 500C483U035AF2B | 13.5 | 14.00 | 1 3/8 x 5 5/8 |
| 51000 | 500C513U035CH2B | 14.8 | 14.50 | 2 1/2 x 2 5/8 |
| 53000 | 500C533U035EC2B | 11.8 | 15.30 | 1 3/4 x 4 1/8 |
| 55000 | 500C553U035BJ2B | 13.2 | 15.00 | 2 x 3 5/8 |
| 62000 | 500C623U035ED2B | 10.6 | 16.80 | 1 3/4 x 4 5/8 |
| 67000 | 500C673U035BC2B | 11.6 | 16.70 | 2 x 4 1/8 |

| Cap. (µF) | Catalog Part Number | ESR Max. @ 25 °C 120 Hz (mΩ) | Ripple Max. @ 85 °C 120 Hz (A) | Nominal Size D x L (inches) |
|------------------------------|---------------------|------------------------------|--------------------------------|-----------------------------|
| 71000 | 500C713U035CB2B | 11.5 | 17.50 | 2 1/2 x 3 1/8 |
| 72000 | 500C723U035EE2B | 9.8 | 18.20 | 1 3/4 x 5 1/8 |
| 80000 | 500C803U035BD2B | 10.5 | 18.20 | 2 x 4 5/8 |
| 82000 | 500C823U035EF2B | 9.4 | 19.20 | 1 3/4 x 5 5/8 |
| 91000 | 500C913U035CJ2B | 9.4 | 20.30 | 2 1/2 x 3 5/8 |
| 92000 | 500C923U035BE2B | 9.8 | 19.50 | 2 x 5 1/8 |
| 100000 | 500C104U035BF2B | 9.4 | 20.70 | 2 x 5 5/8 |
| 110000 | 500C114U035CC2B | 8.2 | 22.60 | 2 1/2 x 4 1/8 |
| 110000 | 500C114U035DB2B | 6.9 | 25.30 | 3 x 3 1/8 |
| 130000 | 500C134U035CD2B | 7.4 | 24.80 | 2 1/2 x 4 5/8 |
| 140000 | 500C144U035DJ2B | 5.7 | 29.10 | 3 x 3 5/8 |
| 150000 | 500C154U035CE2B | 6.8 | 26.80 | 2 1/2 x 5 1/8 |
| 170000 | 500C174U035CF2B | 6.1 | 29.20 | 2 1/2 x 5 5/8 |
| 170000 | 500C174U035DC2D | 5.2 | 32.00 | 3 x 4 1/8 |
| 200000 | 500C204U035DD2D | 4.7 | 34.80 | 3 x 4 5/8 |
| 230000 | 500C234U035DE2D | 4.4 | 37.20 | 3 x 5 1/8 |
| 240000 | 500C244U035FC2D | 4.9 | 36.00 | 3 1/2 x 4 1/8 |
| 260000 | 500C264U035DF2D | 4.0 | 39.90 | 3 x 5 5/8 |
| 270000 | 500C274U035DP2D | 3.9 | 41.30 | 3 x 5 7/8 |
| 280000 | 500C284U035FD2D | 4.5 | 39.00 | 3 1/2 x 4 5/8 |
| 330000 | 500C334U035FE2D | 4.0 | 42.60 | 3 1/2 x 5 1/8 |
| 370000 | 500C374U035FF2D | 3.6 | 46.00 | 3 1/2 x 5 5/8 |
| 380000 | 500C384U035DN2D | 3.8 | 45.30 | 3 x 7 5/8 |
| 390000 | 500C394U035FP2D | 3.5 | 47.50 | 3 1/2 x 5 7/8 |
| 440000 | 500C444U035DG2D | 3.6 | 48.10 | 3 x 8 5/8 |
| 540000 | 500C544U035FN2D | 3.4 | 52.10 | 3 1/2 x 7 5/8 |
| 630000 | 500C634U035FG2D | 3.3 | 55.20 | 3 1/2 x 8 5/8 |
| 50 Vdc (65 Vdc Surge) | | | | |
| 4500 | 500C452U050AK2B | 47.9 | 4.70 | 1 3/8 x 1 5/8 |
| 7600 | 500C762U050AA2B | 30.9 | 6.40 | 1 3/8 x 2 1/8 |
| 11000 | 500C113U050AH2B | 21.8 | 8.30 | 1 3/8 x 2 5/8 |
| 14000 | 500C143U050AB2B | 20.9 | 9.00 | 1 3/8 x 3 1/8 |
| 14000 | 500C143U050EA2B | 22.8 | 8.70 | 1 3/4 x 2 1/8 |
| 16000 | 500C163U050EH2B | 20.2 | 10.00 | 1 3/4 x 2 5/8 |
| 17000 | 500C173U050BA2B | 25.3 | 9.00 | 2 x 2 1/8 |
| 18000 | 500C183U050AJ2B | 17.8 | 10.30 | 1 3/8 x 3 5/8 |
| 21000 | 500C213U050AC2B | 17.3 | 11.00 | 1 3/8 x 4 1/8 |
| 22000 | 500C223U050BH2B | 20.8 | 10.70 | 2 x 2 5/8 |
| 23000 | 500C233U050EB2B | 15.6 | 12.10 | 1 3/4 x 3 1/8 |
| 25000 | 500C253U050AD2B | 16.8 | 11.60 | 1 3/8 x 4 5/8 |
| 29000 | 500C293U050AE2B | 15.1 | 12.70 | 1 3/8 x 5 1/8 |
| 29000 | 500C293U050EJ2B | 13.5 | 13.60 | 1 3/4 x 3 5/8 |
| 29000 | 500C293U050BB2B | 16.3 | 12.80 | 2 x 3 1/8 |
| 32000 | 500C323U050AF2B | 13.8 | 13.80 | 1 3/8 x 5 5/8 |

Type 500C 95 °C Long Life, Screw Terminal, Aluminum

Long Life, High Capacitance Screw Terminal Type

| Cap. (µF) | Catalog Part Number | ESR Max. @ 25 °C 120 Hz (mΩ) | Ripple Max. @ 85°C 120 Hz (A) | Nominal Size D x L (inches) |
|------------------------------|---------------------|------------------------------|-------------------------------|-----------------------------|
| 34000 | 500C343U050CH2B | 15.1 | 14.40 | 2 1/2 x 2 5/8 |
| 36000 | 500C363U050EC2B | 12.0 | 15.20 | 1 3/4 x 4 1/8 |
| 37000 | 500C373U050BJ2B | 13.6 | 14.80 | 2 x 3 5/8 |
| 42000 | 500C423U050ED2B | 10.8 | 16.60 | 1 3/4 x 4 5/8 |
| 46000 | 500C463U050BC2B | 11.9 | 16.50 | 2 x 4 1/8 |
| 48000 | 500C483U050CB2B | 12.0 | 17.10 | 2 1/2 x 3 1/8 |
| 49000 | 500C493U050EE2B | 9.8 | 18.10 | 1 3/4 x 5 1/8 |
| 54000 | 500C543U050BD2B | 10.8 | 18.00 | 2 x 4 5/8 |
| 55000 | 500C553U050EF2B | 9.5 | 19.10 | 1 3/4 x 5 5/8 |
| 62000 | 500C623U050BE2B | 10.0 | 19.40 | 2 x 5 1/8 |
| 62000 | 500C623U050CJ2B | 10.3 | 19.40 | 2 1/2 x 3 5/8 |
| 70000 | 500C703U050BF2B | 9.5 | 20.50 | 2 x 5 5/8 |
| 72000 | 500C723U050DB2B | 9.1 | 22.00 | 3 x 3 1/8 |
| 75000 | 500C753U050CC2B | 8.9 | 21.80 | 2 1/2 x 4 1/8 |
| 89000 | 500C893U050CD2B | 7.9 | 24.00 | 2 1/2 x 4 5/8 |
| 92000 | 500C923U050DJ2B | 7.7 | 25.10 | 3 x 3 5/8 |
| 100000 | 500C104U050CE2B | 7.2 | 26.00 | 2 1/2 x 5 1/8 |
| 110000 | 500C114U050DC2B | 6.9 | 27.60 | 3 x 4 1/8 |
| 120000 | 500C124U050CF2B | 6.7 | 27.90 | 2 1/2 x 5 5/8 |
| 130000 | 500C134U050DD2D | 6.1 | 30.40 | 3 x 4 5/8 |
| 150000 | 500C154U050DE2D | 5.9 | 32.00 | 3 x 5 1/8 |
| 150000 | 500C154U050FC2D | 6.4 | 31.70 | 3 1/2 x 4 1/8 |
| 170000 | 500C174U050DF2D | 5.6 | 33.80 | 3 x 5 5/8 |
| 180000 | 500C184U050DP2D | 5.4 | 35.00 | 3 x 5 7/8 |
| 180000 | 500C184U050FD2D | 5.7 | 34.70 | 3 1/2 x 4 5/8 |
| 200000 | 500C204U050FE2D | 5.4 | 36.80 | 3 1/2 x 5 1/8 |
| 230000 | 500C234U050FF2D | 5.0 | 39.00 | 3 1/2 x 5 5/8 |
| 250000 | 500C254U050FP2D | 5.0 | 40.00 | 3 1/2 x 5 7/8 |
| 260000 | 500C264U050DN2D | 5.0 | 42.00 | 3 x 7 5/8 |
| 300000 | 500C304U050DG2D | 4.0 | 45.00 | 3 x 8 5/8 |
| 340000 | 500C344U050FN2D | 4.0 | 47.00 | 3 1/2 x 7 5/8 |
| 400000 | 500C404U050FG2D | 4.0 | 51.00 | 3 1/2 x 8 5/8 |
| 63 Vdc (75 Vdc Surge) | | | | |
| 3400 | 500C342U063AK2B | 60.6 | 4.10 | 1 3/8 x 1 5/8 |
| 5800 | 500C582U063AA2B | 39.0 | 5.70 | 1 3/8 x 2 1/8 |
| 8200 | 500C822U063AH2B | 27.4 | 7.40 | 1 3/8 x 2 5/8 |
| 11000 | 500C113U063AB2B | 25.2 | 8.20 | 1 3/8 x 3 1/8 |
| 11000 | 500C113U063EA2B | 27.9 | 7.90 | 1 3/4 x 2 1/8 |
| 12000 | 500C123U063EH2B | 25.6 | 8.80 | 1 3/4 x 2 5/8 |
| 13000 | 500C133U063BA2B | 28.0 | 8.50 | 2 x 2 1/8 |
| 14000 | 500C143U063AJ2B | 23.7 | 8.90 | 1 3/8 x 3 5/8 |
| 15000 | 500C153U063BH2B | 22.6 | 10.20 | 2 x 2 5/8 |

| Cap. (µF) | Catalog Part Number | ESR Max. @ 25 °C 120 Hz (mΩ) | Ripple Max. @ 85°C 120 Hz (A) | Nominal Size D x L (inches) |
|------------------------------|---------------------|------------------------------|-------------------------------|-----------------------------|
| 63 Vdc (75 Vdc Surge) | | | | |
| 16000 | 500C163U063AC2B | 20.4 | 10.10 | 1 3/8 x 4 1/8 |
| 17000 | 500C173U063EB2B | 19.5 | 10.80 | 1 3/4 x 3 1/8 |
| 19000 | 500C193U063AD2B | 18.1 | 11.20 | 1 3/8 x 4 5/8 |
| 20000 | 500C203U063BB2B | 18.1 | 12.10 | 2 x 3 1/8 |
| 22000 | 500C223U063AE2B | 16.4 | 12.20 | 1 3/8 x 5 1/8 |
| 22000 | 500C223U063EJ2B | 16.2 | 12.50 | 1 3/4 x 3 5/8 |
| 24000 | 500C243U063CH2B | 26.8 | 10.80 | 2 1/2 x 2 5/8 |
| 25000 | 500C253U063AF2B | 15.1 | 13.20 | 1 3/8 x 5 5/8 |
| 26000 | 500C263U063BJ2B | 15.1 | 14.00 | 2 x 3 5/8 |
| 27000 | 500C273U063EC2B | 14.2 | 14.00 | 1 3/4 x 4 1/8 |
| 32000 | 500C323U063ED2B | 12.8 | 15.30 | 1 3/4 x 4 5/8 |
| 32000 | 500C323U063BC2B | 13.3 | 15.60 | 2 x 4 1/8 |
| 34000 | 500C343U063CB2B | 19.3 | 13.50 | 2 1/2 x 3 1/8 |
| 37000 | 500C373U063EE2B | 11.8 | 16.50 | 1 3/4 x 5 1/8 |
| 38000 | 500C383U063BD2B | 12.1 | 17.00 | 2 x 4 5/8 |
| 42000 | 500C423U063EF2B | 11.2 | 17.60 | 1 3/4 x 5 5/8 |
| 43000 | 500C433U063CJ2B | 17.1 | 15.10 | 2 1/2 x 3 5/8 |
| 44000 | 500C443U063BE2B | 11.3 | 18.30 | 2 x 5 1/8 |
| 49000 | 500C493U063BF2B | 10.7 | 19.40 | 2 x 5 5/8 |
| 50000 | 500C503U063DB2B | 14.9 | 17.20 | 3 x 3 1/8 |
| 53000 | 500C533U063CC2B | 13.7 | 17.50 | 2 1/2 x 4 1/8 |
| 62000 | 500C623U063CD2B | 11.8 | 19.60 | 2 1/2 x 4 5/8 |
| 65000 | 500C653U063DJ2B | 12.1 | 20.00 | 3 x 3 5/8 |
| 72000 | 500C723U063CE2B | 11.0 | 21.10 | 2 1/2 x 5 1/8 |
| 79000 | 500C793U063DC2B | 10.8 | 22.10 | 3 x 4 1/8 |
| 82000 | 500C823U063CF2B | 10.5 | 22.30 | 2 1/2 x 5 5/8 |
| 93000 | 500C933U063DD2B | 9.9 | 23.90 | 3 x 4 5/8 |
| 110000 | 500C114U063DE2B | 8.8 | 26.30 | 3 x 5 1/8 |
| 110000 | 500C114U063FC2D | 9.9 | 25.40 | 3 1/2 x 4 1/8 |
| 120000 | 500C124U063DF2B | 7.9 | 28.50 | 3 x 5 5/8 |
| 130000 | 500C134U063DP2B | 7.5 | 29.60 | 3 x 5 7/8 |
| 130000 | 500C134U063FD2D | 9.0 | 27.60 | 3 1/2 x 4 5/8 |
| 150000 | 500C154U063FE2D | 7.9 | 30.30 | 3 1/2 x 5 1/8 |
| 170000 | 500C174U063FF2D | 7.2 | 32.80 | 3 1/2 x 5 5/8 |
| 180000 | 500C184U063DN2D | 6.5 | 35.00 | 3 x 7 5/8 |
| 180000 | 500C184U063FP2D | 6.8 | 34.00 | 3 1/2 x 5 7/8 |
| 210000 | 500C214U063DG2D | 5.7 | 38.30 | 3 x 8 5/8 |
| 250000 | 500C254U063FN2D | 5.8 | 40.20 | 3 1/2 x 7 5/8 |
| 290000 | 500C294U063FG2D | 5.2 | 43.90 | 3 1/2 x 8 5/8 |
| 75 Vdc (95 Vdc Surge) | | | | |
| 2700 | 500C272U075AK2B | 76.2 | 3.70 | 1 3/8 x 1 5/8 |

Type 500C 95 °C Long Life, Screw Terminal, Aluminum

Long Life, High Capacitance Screw Terminal Type

| Cap. (µF) | Catalog Part Number | ESR Max. @ 25 °C 120 Hz (mΩ) | Ripple Max. @ 85°C 120 Hz (A) | Nominal Size D x L (inches) |
|------------------------------|---------------------|------------------------------|-------------------------------|-----------------------------|
| 75 Vdc (95 Vdc Surge) | | | | |
| 4300 | 500C432U075AA2B | 50.7 | 5.00 | 1 3/8 x 2 1/8 |
| 6400 | 500C642U075AH2B | 35.0 | 6.50 | 1 3/8 x 2 5/8 |
| 8300 | 500C832U075EA2B | 55.6 | 5.60 | 1 3/4 x 2 1/8 |
| 8600 | 500C862U075AB2B | 34.0 | 7.10 | 1 3/8 x 3 1/8 |
| 9800 | 500C982U075EH2B | 47.3 | 6.50 | 1 3/4 x 2 5/8 |
| 10000 | 500C103U075BA2B | 34.8 | 7.70 | 2 x 2 1/8 |
| 11000 | 500C113U075AJ2B | 31.1 | 7.80 | 1 3/8 x 3 5/8 |
| 11000 | 500C113U075BH2B | 27.5 | 9.30 | 2 x 2 5/8 |
| 13000 | 500C133U075AC2B | 28.2 | 8.60 | 1 3/8 x 4 1/8 |
| 14000 | 500C143U075EB2B | 34.1 | 8.20 | 1 3/4 x 3 1/8 |
| 15000 | 500C153U075AD2B | 24.5 | 9.60 | 1 3/8 x 4 5/8 |
| 16000 | 500C163U075BB2B | 21.4 | 11.20 | 2 x 3 1/8 |
| 17000 | 500C173U075AE2B | 22.5 | 10.40 | 1 3/8 x 5 1/8 |
| 18000 | 500C183U075EJ2B | 26.9 | 9.70 | 1 3/4 x 3 5/8 |
| 19000 | 500C193U075AF2B | 20.4 | 11.30 | 1 3/8 x 5 5/8 |
| 19000 | 500C193U075CH2B | 30.0 | 10.20 | 2 1/2 x 2 5/8 |
| 21000 | 500C213U075EC2B | 22.3 | 11.10 | 1 3/4 x 4 1/8 |
| 21000 | 500C213U075BJ2B | 18.0 | 12.80 | 2 x 3 5/8 |
| 25000 | 500C253U075ED2B | 19.2 | 12.50 | 1 3/4 x 4 5/8 |
| 25000 | 500C253U075BC2B | 15.6 | 14.40 | 2 x 4 1/8 |
| 26000 | 500C263U075CB2B | 21.6 | 12.70 | 2 1/2 x 3 1/8 |
| 29000 | 500C293U075EE2B | 16.9 | 13.80 | 1 3/4 x 5 1/8 |
| 30000 | 500C303U075BD2B | 13.9 | 15.80 | 2 x 4 5/8 |
| 33000 | 500C333U075EF2B | 15.2 | 15.10 | 1 3/4 x 5 5/8 |
| 34000 | 500C343U075BE2B | 12.8 | 17.10 | 2 x 5 1/8 |
| 34000 | 500C343U075CJ2B | 17.8 | 14.80 | 2 1/2 x 3 5/8 |
| 39000 | 500C393U075BF2B | 12.0 | 18.30 | 2 x 5 5/8 |
| 40000 | 500C403U075DB2B | 18.0 | 15.60 | 3 x 3 1/8 |
| 42000 | 500C423U075CC2B | 15.1 | 16.70 | 2 1/2 x 4 1/8 |
| 49000 | 500C493U075CD2B | 13.5 | 18.40 | 2 1/2 x 4 5/8 |
| 51000 | 500C513U075DJ2B | 14.4 | 18.30 | 3 x 3 5/8 |
| 57000 | 500C573U075CE2B | 12.0 | 20.20 | 2 1/2 x 5 1/8 |
| 62000 | 500C623U075DC2B | 12.9 | 20.20 | 3 x 4 1/8 |
| 64000 | 500C643U075CF2B | 11.2 | 21.50 | 2 1/2 x 5 5/8 |
| 74000 | 500C743U075DD2B | 11.8 | 21.90 | 3 x 4 5/8 |
| 85000 | 500C853U075DE2B | 10.4 | 24.10 | 3 x 5 1/8 |
| 85000 | 500C853U075FC2D | 11.8 | 23.20 | 3 1/2 x 4 1/8 |
| 96000 | 500C963U075DF2B | 9.4 | 26.20 | 3 x 5 5/8 |
| 100000 | 500C104U075DP2B | 8.9 | 27.20 | 3 x 5 7/8 |
| 100000 | 500C104U075FD2D | 10.7 | 25.30 | 3 1/2 x 4 5/8 |
| 120000 | 500C124U075FE2D | 9.4 | 27.80 | 3 1/2 x 5 1/8 |
| 130000 | 500C134U075FF2D | 8.4 | 30.20 | 3 1/2 x 5 5/8 |
| 140000 | 500C144U075DN2D | 7.7 | 32.10 | 3 x 7 5/8 |

| Cap. (µF) | Catalog Part Number | ESR Max. @ 25 °C 120 Hz (mΩ) | Ripple Max. @ 85°C 120 Hz (A) | Nominal Size D x L (inches) |
|--------------------------------|---------------------|------------------------------|-------------------------------|-----------------------------|
| 140000 | 500C144U075FP2D | 8.1 | 31.30 | 3 1/2 x 5 7/8 |
| 160000 | 500C164U075DG2D | 6.8 | 35.10 | 3 x 8 5/8 |
| 190000 | 500C194U075FN2D | 6.9 | 36.80 | 3 1/2 x 7 5/8 |
| 220000 | 500C224U075FG2D | 6.2 | 40.20 | 3 1/2 x 8 5/8 |
| 100 Vdc (125 Vdc Surge) | | | | |
| 1600 | 500C162U100AK2B | 98.4 | 3.30 | 1 3/8 x 1 5/8 |
| 2500 | 500C252U100AA2B | 60.2 | 4.60 | 1 3/8 x 2 1/8 |
| 3800 | 500C382U100AH2B | 42.7 | 5.90 | 1 3/8 x 2 5/8 |
| 4900 | 500C492U100EA2B | 62.0 | 5.30 | 1 3/4 x 2 1/8 |
| 5100 | 500C512U100AB2B | 38.2 | 6.70 | 1 3/8 x 3 1/8 |
| 5100 | 500C512U100BA2B | 51.8 | 6.30 | 2 x 2 1/8 |
| 5800 | 500C582U100EH2B | 52.8 | 6.20 | 1 3/4 x 2 5/8 |
| 6300 | 500C632U100AJ2B | 33.0 | 7.60 | 1 3/8 x 3 5/8 |
| 7300 | 500C732U100BH2B | 37.8 | 7.90 | 2 x 2 5/8 |
| 7600 | 500C762U100AC2B | 30.7 | 8.20 | 1 3/8 x 4 1/8 |
| 8100 | 500C812U100EB2B | 38.0 | 7.70 | 1 3/4 x 3 1/8 |
| 8900 | 500C892U100AD2B | 29.0 | 8.80 | 1 3/8 x 4 5/8 |
| 10000 | 500C103U100AE2B | 28.3 | 9.30 | 1 3/8 x 5 1/8 |
| 10000 | 500C103U100EJ2B | 29.9 | 9.20 | 1 3/4 x 3 5/8 |
| 10000 | 500C103U100BB2B | 30.6 | 9.30 | 2 x 3 1/8 |
| 11000 | 500C113U100AF2B | 27.6 | 9.70 | 1 3/8 x 5 5/8 |
| 12000 | 500C123U100CH2B | 33.7 | 9.60 | 2 1/2 x 2 5/8 |
| 13000 | 500C133U100EC2B | 24.8 | 10.60 | 1 3/4 x 4 1/8 |
| 13000 | 500C133U100BJ2B | 22.3 | 11.50 | 2 x 3 5/8 |
| 15000 | 500C153U100ED2B | 21.2 | 11.90 | 1 3/4 x 4 5/8 |
| 16000 | 500C163U100BC2B | 19.9 | 12.80 | 2 x 4 1/8 |
| 17000 | 500C173U100EE2B | 18.7 | 13.10 | 1 3/4 x 5 1/8 |
| 17000 | 500C173U100CB2B | 23.4 | 12.30 | 2 1/2 x 3 1/8 |
| 19000 | 500C193U100BD2B | 17.7 | 14.10 | 2 x 4 5/8 |
| 20000 | 500C203U100EF2B | 16.8 | 14.30 | 1 3/4 x 5 5/8 |
| 22000 | 500C223U100BE2B | 15.6 | 15.50 | 2 x 5 1/8 |
| 22000 | 500C223U100CJ2B | 19.1 | 14.30 | 2 1/2 x 3 5/8 |
| 25000 | 500C253U100BF2B | 14.9 | 16.40 | 2 x 5 5/8 |
| 25000 | 500C253U100DB2B | 19.9 | 14.90 | 3 x 3 1/8 |
| 27000 | 500C273U100CC2B | 16.5 | 16.00 | 2 1/2 x 4 1/8 |
| 32000 | 500C323U100CD2B | 14.7 | 17.60 | 2 1/2 x 4 5/8 |
| 33000 | 500C333U100DJ2B | 16.4 | 17.20 | 3 x 3 5/8 |
| 36000 | 500C363U100CE2B | 13.4 | 19.10 | 2 1/2 x 5 1/8 |
| 40000 | 500C403U100DC2B | 14.4 | 19.10 | 3 x 4 1/8 |
| 41000 | 500C413U100CF2B | 12.5 | 20.40 | 2 1/2 x 5 5/8 |
| 47000 | 500C473U100DD2B | 13.0 | 20.90 | 3 x 4 5/8 |
| 54000 | 500C543U100DE2B | 12.0 | 22.50 | 3 x 5 1/8 |
| 55000 | 500C553U100FC2D | 13.4 | 21.80 | 3 1/2 x 4 1/8 |
| 62000 | 500C623U100DF2B | 11.2 | 23.90 | 3 x 5 5/8 |

Type 500C 95 °C Long Life, Screw Terminal, Aluminum

Long Life, High Capacitance Screw Terminal Type

| Cap. (µF) | Catalog Part Number | ESR Max. @ 25 °C 120 Hz (mΩ) | Ripple Max. @ 85 °C 120 Hz (A) | Nominal Size D x L (inches) |
|--------------------------------|---------------------|------------------------------|--------------------------------|-----------------------------|
| 100 Vdc (125 Vdc Surge) | | | | |
| 65000 | 500C653U100DP2B | 11.1 | 24.40 | 3 x 5 7/8 |
| 65000 | 500C653U100FD2D | 12.1 | 23.80 | 3 1/2 x 4 5/8 |
| 74000 | 500C743U100FE2D | 10.9 | 25.90 | 3 1/2 x 5 1/8 |
| 84000 | 500C843U100FF2D | 10.2 | 27.50 | 3 1/2 x 5 5/8 |
| 89000 | 500C893U100FP2D | 10.0 | 28.10 | 3 1/2 x 5 7/8 |
| 94000 | 500C943U100DN2D | 9.2 | 29.40 | 3 x 7 5/8 |
| 110000 | 500C114U100DG2D | 8.2 | 32.10 | 3 x 8 5/8 |
| 120000 | 500C124U100FN2D | 8.3 | 33.70 | 3 1/2 x 7 5/8 |
| 140000 | 500C144U100FG2D | 7.3 | 36.80 | 3 1/2 x 8 5/8 |
| 160 Vdc (200 Vdc) | | | | |
| 750 | 500C751T160AK2B | 150.0 | 2.60 | 1 3/8 x 1 5/8 |
| 1200 | 500C122T160AA2B | 93.0 | 3.70 | 1 3/8 x 2 1/8 |
| 1500 | 500C152T160AH2B | 70.5 | 4.60 | 1 3/8 x 2 5/8 |
| 2100 | 500C212T160AB2B | 58.5 | 5.40 | 1 3/8 x 3 1/8 |
| 2300 | 500C232T160EA2B | 62.0 | 5.30 | 1 3/4 x 2 1/8 |
| 2400 | 500C242T160BA2B | 70.5 | 5.40 | 2 x 2 1/8 |
| 2700 | 500C272T160AJ2B | 50.2 | 6.10 | 1 3/8 x 3 5/8 |
| 2700 | 500C272T160EH2B | 52.8 | 6.20 | 1 3/4 x 2 5/8 |
| 3300 | 500C332T160AC2B | 42.9 | 7.00 | 1 3/8 x 4 1/8 |
| 3500 | 500C352T160BH2B | 46.5 | 7.10 | 2 x 2 5/8 |
| 3800 | 500C382T160EB2B | 38.0 | 7.70 | 1 3/4 x 3 1/8 |
| 3900 | 500C392T160AD2B | 37.7 | 7.70 | 1 3/8 x 4 5/8 |
| 4500 | 500C452T160AE2B | 34.7 | 8.40 | 1 3/8 x 5 1/8 |
| 4900 | 500C492T160EJ2B | 29.9 | 9.20 | 1 3/4 x 3 5/8 |
| 4900 | 500C492T160BB2B | 33.5 | 8.90 | 2 x 3 1/8 |
| 5100 | 500C512T160AF2B | 32.2 | 9.00 | 1 3/8 x 5 5/8 |
| 5500 | 500C552T160CH2B | 30.1 | 10.20 | 2 1/2 x 2 5/8 |
| 6000 | 500C602T160EC2B | 24.8 | 10.60 | 1 3/4 x 4 1/8 |
| 6300 | 500C632T160BJ2B | 26.4 | 10.60 | 2 x 3 5/8 |
| 7100 | 500C712T160ED2B | 21.2 | 11.90 | 1 3/4 x 4 5/8 |
| 7700 | 500C772T160BC2B | 21.9 | 12.20 | 2 x 4 1/8 |
| 7700 | 500C772T160CB2B | 21.3 | 12.80 | 2 1/2 x 3 1/8 |
| 8200 | 500C822T160EE2B | 18.7 | 13.10 | 1 3/4 x 5 1/8 |
| 9100 | 500C912T160BD2B | 18.8 | 13.60 | 2 x 4 5/8 |
| 9300 | 500C932T160EF2B | 16.8 | 14.30 | 1 3/4 x 5 5/8 |
| 9900 | 500C992T160CJ2B | 17.0 | 15.10 | 2 1/2 x 3 5/8 |
| 10000 | 500C103T160BE2B | 16.6 | 15.00 | 2 x 5 1/8 |
| 11000 | 500C113T160DB2B | 14.7 | 17.30 | 3 x 3 1/8 |
| 12000 | 500C123T160BF2B | 14.9 | 16.40 | 2 x 5 5/8 |
| 12000 | 500C123T160CC2B | 14.1 | 17.30 | 2 1/2 x 4 1/8 |
| 14000 | 500C143T160CD2B | 11.9 | 19.60 | 2 1/2 x 4 5/8 |

| Cap. (µF) | Catalog Part Number | ESR Max. @ 25 °C 120 Hz (mΩ) | Ripple Max. @ 85 °C 120 Hz (A) | Nominal Size D x L (inches) |
|--------------------------------|---------------------|------------------------------|--------------------------------|-----------------------------|
| 160 Vdc (200 Vdc) | | | | |
| 15000 | 500C153T160DJ2B | 11.5 | 20.50 | 3 x 3 5/8 |
| 16000 | 500C163T160CE2B | 10.7 | 21.30 | 2 1/2 x 5 1/8 |
| 18000 | 500C183T160DC2B | 9.6 | 23.40 | 3 x 4 1/8 |
| 19000 | 500C193T160CF2B | 9.6 | 23.20 | 2 1/2 x 5 5/8 |
| 21000 | 500C213T160DD2B | 8.2 | 26.20 | 3 x 4 5/8 |
| 25000 | 500C253T160DE2B | 7.3 | 28.90 | 3 x 5 1/8 |
| 25000 | 500C253T160FC2D | 9.2 | 26.40 | 3 1/2 x 4 1/8 |
| 28000 | 500C283T160DF2D | 6.5 | 31.40 | 3 x 5 5/8 |
| 29000 | 500C293T160DP2D | 6.2 | 32.60 | 3 x 5 7/8 |
| 29000 | 500C293T160FD2D | 7.9 | 29.50 | 3 1/2 x 4 5/8 |
| 34000 | 500C343T160FE2D | 6.9 | 32.40 | 3 1/2 x 5 1/8 |
| 38000 | 500C383T160FF2D | 6.2 | 35.10 | 3 1/2 x 5 5/8 |
| 40000 | 500C403T160FP2D | 5.9 | 36.50 | 3 1/2 x 5 7/8 |
| 41000 | 500C413T160DN2D | 5.1 | 39.80 | 3 x 7 5/8 |
| 47000 | 500C473T160DG2D | 4.3 | 44.00 | 3 x 8 5/8 |
| 56000 | 500C563T160FN2D | 4.9 | 44.30 | 3 1/2 x 7 5/8 |
| 65000 | 500C653T160FG2D | 4.2 | 48.80 | 3 1/2 x 8 5/8 |
| 200 Vdc (250 Vdc Surge) | | | | |
| 540 | 500C541T200AK2B | 206.0 | 2.30 | 1 3/8 x 1 5/8 |
| 770 | 500C771T200AA2B | 140.0 | 3.00 | 1 3/8 x 2 1/8 |
| 970 | 500C971T200AH2B | 101.0 | 3.90 | 1 3/8 x 2 5/8 |
| 1400 | 500C142T200AB2B | 78.5 | 4.60 | 1 3/8 x 3 1/8 |
| 1500 | 500C152T200EA2B | 79.1 | 4.70 | 1 3/4 x 2 1/8 |
| 1600 | 500C162T200BA2B | 82.0 | 5.00 | 2 x 2 1/8 |
| 1700 | 500C172T200AJ2B | 63.9 | 5.40 | 1 3/8 x 3 5/8 |
| 1700 | 500C172T200EH2B | 62.5 | 5.70 | 1 3/4 x 2 5/8 |
| 2100 | 500C212T200AC2B | 51.7 | 6.30 | 1 3/8 x 4 1/8 |
| 2200 | 500C222T200BH2B | 61.0 | 6.20 | 2 x 2 5/8 |
| 2400 | 500C242T200EB2B | 48.4 | 6.90 | 1 3/4 x 3 1/8 |
| 2500 | 500C252T200AD2B | 43.2 | 7.20 | 1 3/8 x 4 5/8 |
| 2900 | 500C292T200AE2B | 37.8 | 8.00 | 1 3/8 x 5 1/8 |
| 3100 | 500C312T200EJ2B | 37.9 | 8.20 | 1 3/4 x 3 5/8 |
| 3100 | 500C312T200BB2B | 46.1 | 7.60 | 2 x 3 1/8 |
| 3300 | 500C332T200AF2B | 33.4 | 8.90 | 1 3/8 x 5 5/8 |
| 3500 | 500C352T200CH2B | 42.2 | 8.60 | 2 1/2 x 2 5/8 |
| 3800 | 500C382T200EC2B | 31.3 | 9.40 | 1 3/4 x 4 1/8 |
| 4000 | 500C402T200BJ2B | 36.2 | 9.00 | 2 x 3 5/8 |
| 4500 | 500C452T200ED2B | 26.8 | 10.60 | 1 3/4 x 4 5/8 |
| 4900 | 500C492T200BC2B | 28.5 | 10.60 | 2 x 4 1/8 |
| 4900 | 500C492T200CB2B | 31.2 | 10.60 | 2 1/2 x 3 1/8 |
| 5200 | 500C522T200EE2B | 23.5 | 11.70 | 1 3/4 x 5 1/8 |

Type 500C 95 °C Long Life, Screw Terminal, Aluminum

Long Life, High Capacitance Screw Terminal Type

| Cap. (µF) | Catalog Part Number | ESR Max. @ 25 °C 120 Hz (mΩ) | Ripple Max. @ 85°C 120 Hz (A) | Nominal Size D x L (inches) |
|--------------------------------|---------------------|------------------------------|-------------------------------|-----------------------------|
| 200 Vdc (250 Vdc Surge) | | | | |
| 5800 | 500C582T200BD2B | 24.4 | 12.00 | 2 x 4 5/8 |
| 5900 | 500C592T200EF2B | 21.0 | 12.80 | 1 3/4 x 5 5/8 |
| 6200 | 500C622T200CJ2B | 22.3 | 13.20 | 2 1/2 x 3 5/8 |
| 6700 | 500C672T200BE2B | 21.7 | 13.20 | 2 x 5 1/8 |
| 7600 | 500C762T200BF2B | 19.6 | 14.30 | 2 x 5 5/8 |
| 7600 | 500C762T200CC2B | 20.3 | 14.40 | 2 1/2 x 4 1/8 |
| 7600 | 500C762T200DB2B | 30.3 | 12.10 | 3 x 3 1/8 |
| 9000 | 500C902T200CD2B | 17.3 | 16.20 | 2 1/2 x 4 5/8 |
| 9800 | 500C982T200DJ2B | 23.7 | 14.30 | 3 x 3 5/8 |
| 10000 | 500C103T200CE2B | 15.8 | 17.60 | 2 1/2 x 5 1/8 |
| 12000 | 500C123T200CF2B | 13.7 | 19.40 | 2 1/2 x 5 5/8 |
| 12000 | 500C123T200DC2B | 19.7 | 16.30 | 3 x 4 1/8 |
| 14000 | 500C143T200DD2B | 16.9 | 18.30 | 3 x 4 5/8 |
| 15000 | 500C153T200FC2B | 17.1 | 19.30 | 3 1/2 x 4 1/8 |
| 16000 | 500C163T200FG2B | 14.8 | 20.20 | 3 x 5 1/8 |
| 18000 | 500C183T200DF2B | 13.3 | 22.00 | 3 x 5 5/8 |
| 19000 | 500C193T200DP2B | 15.3 | 20.70 | 3 x 5 7/8 |
| 20000 | 500C203T200FD2B | 12.7 | 23.30 | 3 1/2 x 4 5/8 |
| 21000 | 500C213T200FE2D | 13.4 | 23.30 | 3 1/2 x 5 1/8 |
| 24000 | 500C243T200FF2D | 12.0 | 25.30 | 3 1/2 x 5 5/8 |
| 25000 | 500C253T200FP2D | 11.5 | 26.30 | 3 1/2 x 5 7/8 |
| 26000 | 500C263T200DN2B | 11.7 | 26.40 | 3 x 7 5/8 |
| 31000 | 500C313T200DG2B | 9.6 | 29.60 | 3 x 8 5/8 |
| 35000 | 500C353T200FN2D | 9.3 | 32.10 | 3 1/2 x 7 5/8 |
| 40000 | 500C403T200FG2D | 7.9 | 35.50 | 3 1/2 x 8 5/8 |
| 250 Vdc (300 Vdc Surge) | | | | |
| 380 | 500C381T250AK2B | 260.0 | 2.00 | 1 3/8 x 1 5/8 |
| 680 | 500C681T250AA2B | 156.0 | 2.90 | 1 3/8 x 2 1/8 |
| 830 | 500C831T250AH2B | 119.0 | 3.50 | 1 3/8 x 2 5/8 |
| 1100 | 500C112T250AB2B | 87.5 | 4.40 | 1 3/8 x 3 1/8 |
| 1100 | 500C112T250EA2B | 99.1 | 4.20 | 1 3/4 x 2 1/8 |
| 1200 | 500C122T250BA2B | 94.6 | 4.60 | 2 x 2 1/8 |
| 1300 | 500C132T250EH2B | 82.8 | 4.90 | 1 3/4 x 2 5/8 |
| 1400 | 500C142T250AJ2B | 69.5 | 5.20 | 1 3/8 x 3 5/8 |
| 1700 | 500C172T250AC2B | 57.8 | 6.00 | 1 3/8 x 4 1/8 |
| 1700 | 500C172T250BH2B | 65.7 | 6.00 | 2 x 2 5/8 |
| 1800 | 500C182T250EB2B | 61.1 | 6.10 | 1 3/4 x 3 1/8 |
| 2000 | 500C202T250AD2B | 51.5 | 6.60 | 1 3/8 x 4 5/8 |
| 2300 | 500C232T250AE2B | 44.1 | 7.40 | 1 3/8 x 5 1/8 |
| 2300 | 500C232T250EJ2B | 48.5 | 7.20 | 1 3/4 x 3 5/8 |
| 2400 | 500C242T250BB2B | 46.2 | 7.60 | 2 x 3 1/8 |
| 2600 | 500C262T250AF2B | 38.4 | 8.30 | 1 3/8 x 5 5/8 |
| 2600 | 500C262T250CH2B | 51.6 | 7.80 | 2 1/2 x 2 5/8 |

| Cap. (µF) | Catalog Part Number | ESR Max. @ 25 °C 120 Hz (mΩ) | Ripple Max. @ 85°C 120 Hz (A) | Nominal Size D x L (inches) |
|--------------------------------|---------------------|------------------------------|-------------------------------|-----------------------------|
| 250 Vdc (300 Vdc Surge) | | | | |
| 2800 | 500C282T250EC2B | 40.4 | 8.30 | 1 3/4 x 4 1/8 |
| 3100 | 500C312T250BJ2B | 38.1 | 8.80 | 2 x 3 5/8 |
| 3300 | 500C332T250ED2B | 34.7 | 9.30 | 1 3/4 x 4 5/8 |
| 3700 | 500C372T250CB2B | 32.0 | 10.50 | 2 1/2 x 3 1/8 |
| 3800 | 500C382T250EE2B | 30.5 | 10.30 | 1 3/4 x 5 1/8 |
| 3800 | 500C382T250BC2B | 31.4 | 10.10 | 2 x 4 1/8 |
| 4300 | 500C432T250EF2B | 27.3 | 11.20 | 1 3/4 x 5 5/8 |
| 4500 | 500C452T250BD2B | 26.9 | 11.40 | 2 x 4 5/8 |
| 4700 | 500C472T250CJ2B | 25.0 | 12.40 | 2 1/2 x 3 5/8 |
| 5200 | 500C522T250BE2B | 23.6 | 12.60 | 2 x 5 1/8 |
| 5600 | 500C562T250DB2B | 27.6 | 12.60 | 3 x 3 1/8 |
| 5800 | 500C582T250CC2B | 20.7 | 14.30 | 2 1/2 x 4 1/8 |
| 5900 | 500C592T250BF2B | 21.0 | 13.80 | 2 x 5 5/8 |
| 6900 | 500C692T250CD2B | 17.7 | 16.10 | 2 1/2 x 4 5/8 |
| 7200 | 500C722T250DJ2B | 21.6 | 15.00 | 3 x 3 5/8 |
| 7900 | 500C792T250CE2B | 15.5 | 17.70 | 2 1/2 x 5 1/8 |
| 8800 | 500C882T250DC2B | 17.6 | 17.30 | 3 x 4 1/8 |
| 9000 | 500C902T250CF2B | 13.8 | 19.40 | 2 1/2 x 5 5/8 |
| 10000 | 500C103T250DD2B | 16.3 | 18.60 | 3 x 4 5/8 |
| 11000 | 500C113T250FC2D | 19.5 | 18.10 | 3 1/2 x 4 1/8 |
| 12000 | 500C123T250DE2B | 14.3 | 20.60 | 3 x 5 1/8 |
| 13000 | 500C133T250FD2D | 17.2 | 19.90 | 3 1/2 x 4 5/8 |
| 14000 | 500C143T250DF2B | 12.0 | 23.20 | 3 x 5 5/8 |
| 15000 | 500C153T250DP2B | 11.5 | 23.90 | 3 x 5 7/8 |
| 15000 | 500C153T250FE2D | 15.1 | 22.00 | 3 1/2 x 5 1/8 |
| 17000 | 500C173T250FF2D | 13.2 | 24.20 | 3 1/2 x 5 5/8 |
| 18000 | 500C183T250FP2D | 12.8 | 24.80 | 3 1/2 x 5 7/8 |
| 21000 | 500C213T250DN2D | 9.6 | 30.90 | 3 x 7 5/8 |
| 24000 | 500C243T250DG2D | 7.0 | 34.60 | 3 x 8 5/8 |
| 25000 | 500C253T250FN2D | 10.5 | 30.00 | 3 1/2 x 7 5/8 |
| 29000 | 500C293T250FG2D | 9.2 | 33.00 | 3 1/2 x 8 5/8 |
| 300 Vdc (350 Vdc Surge) | | | | |
| 290 | 500C291T300AK2B | 418.0 | 1.60 | 1 3/8 x 1 5/8 |
| 520 | 500C521T300AA2B | 231.0 | 2.30 | 1 3/8 x 2 1/8 |
| 630 | 500C631T300AH2B | 189.0 | 2.80 | 1 3/8 x 2 5/8 |
| 870 | 500C871T300AB2B | 138.0 | 3.50 | 1 3/8 x 3 1/8 |
| 870 | 500C871T300EA2B | 139.0 | 3.50 | 1 3/4 x 2 1/8 |
| 1000 | 500C102T300BA2B | 131.0 | 3.90 | 2 x 2 1/8 |
| 1100 | 500C112T300AJ2B | 107.0 | 4.20 | 1 3/8 x 3 5/8 |
| 1100 | 500C112T300EH2B | 117.0 | 4.10 | 1 3/4 x 2 5/8 |
| 1300 | 500C132T300AC2B | 90.4 | 4.80 | 1 3/8 x 4 1/8 |
| 1300 | 500C132T300BH2B | 103.0 | 4.80 | 2 x 2 5/8 |
| 1400 | 500C142T300EB2B | 84.5 | 5.20 | 1 3/4 x 3 1/8 |

Type 500C 95 °C Long Life, Screw Terminal, Aluminum

Long Life, High Capacitance Screw Terminal Type

| Cap. (µF) | Catalog Part Number | ESR Max. @ 25 °C 120 Hz (mΩ) | Ripple Max. @ 85°C 120 Hz (A) | Nominal Size D x L (inches) |
|--------------------------------|---------------------|------------------------------|-------------------------------|-----------------------------|
| 300 Vdc (350 Vdc Surge) | | | | |
| 1600 | 500C162T300AD2B | 77.4 | 5.40 | 1 3/8 x 4 5/8 |
| 1800 | 500C182T300AE2B | 65.7 | 6.10 | 1 3/8 x 5 1/8 |
| 1800 | 500C182T300EJ2B | 68.3 | 6.10 | 1 3/4 x 3 5/8 |
| 1900 | 500C192T300BB2B | 71.1 | 6.10 | 2 x 3 1/8 |
| 2000 | 500C202T300AF2B | 60.3 | 6.60 | 1 3/8 x 5 5/8 |
| 2200 | 500C222T300EC2B | 56.7 | 7.00 | 1 3/4 x 4 1/8 |
| 2200 | 500C222T300CH2B | 60.5 | 7.20 | 2 1/2 x 2 5/8 |
| 2400 | 500C242T300BJ2B | 55.5 | 7.30 | 2 x 3 5/8 |
| 2600 | 500C262T300ED2B | 48.5 | 7.90 | 1 3/4 x 4 5/8 |
| 2900 | 500C292T300BC2B | 45.7 | 8.40 | 2 x 4 1/8 |
| 2900 | 500C292T300CB2B | 46.5 | 8.70 | 2 1/2 x 3 1/8 |
| 3000 | 500C302T300EE2B | 42.5 | 8.70 | 1 3/4 x 5 1/8 |
| 3400 | 500C342T300EF2B | 37.9 | 9.50 | 1 3/4 x 5 5/8 |
| 3500 | 500C352T300BD2B | 38.9 | 9.50 | 2 x 4 5/8 |
| 3700 | 500C372T300CJ2B | 38.1 | 10.10 | 2 1/2 x 3 5/8 |
| 4000 | 500C402T300BE2B | 34.0 | 10.50 | 2 x 5 1/8 |
| 4100 | 500C412T300DB2B | 42.8 | 10.10 | 3 x 3 1/8 |
| 4500 | 500C452T300BF2B | 30.2 | 11.50 | 2 x 5 5/8 |
| 4500 | 500C452T300CC2B | 29.9 | 11.90 | 2 1/2 x 4 1/8 |
| 5200 | 500C522T300DJ2B | 34.0 | 11.90 | 3 x 3 5/8 |
| 5300 | 500C532T300CD2B | 25.5 | 13.40 | 2 1/2 x 4 5/8 |
| 6100 | 500C612T300CE2B | 22.2 | 14.80 | 2 1/2 x 5 1/8 |
| 6400 | 500C642T300DC2B | 26.2 | 14.20 | 3 x 4 1/8 |
| 6900 | 500C692T300CF2B | 19.8 | 16.20 | 2 1/2 x 5 5/8 |
| 7500 | 500C752T300DD2B | 23.6 | 15.50 | 3 x 4 5/8 |
| 8700 | 500C872T300DE2B | 20.5 | 17.20 | 3 x 5 1/8 |
| 8900 | 500C892T300FC2D | 21.0 | 17.40 | 3 1/2 x 4 1/8 |
| 9800 | 500C982T300DF2B | 18.0 | 18.90 | 3 x 5 5/8 |
| 10000 | 500C103T300DP2B | 17.0 | 19.70 | 3 x 5 7/8 |
| 10000 | 500C103T300FD2D | 18.2 | 19.40 | 3 1/2 x 4 5/8 |
| 12000 | 500C123T300FE2D | 16.0 | 21.30 | 3 1/2 x 5 1/8 |
| 13000 | 500C133T300FF2D | 14.3 | 23.20 | 3 1/2 x 5 5/8 |
| 14000 | 500C143T300FP2D | 13.5 | 24.20 | 3 1/2 x 5 7/8 |
| 15000 | 500C153T300DN2B | 13.2 | 24.90 | 3 x 7 5/8 |
| 17000 | 500C173T300DG2B | 10.8 | 27.90 | 3 x 8 5/8 |
| 19000 | 500C193T300FN2D | 11.0 | 29.50 | 3 1/2 x 7 5/8 |
| 22000 | 500C223T300FG2D | 9.3 | 32.60 | 3 1/2 x 8 5/8 |
| 350 Vdc (400 Vdc Surge) | | | | |
| 200 | 500C201T350AK2B | 605.0 | 1.30 | 1 3/8 x 1 5/8 |
| 320 | 500C321T350AA2B | 379.0 | 1.80 | 1 3/8 x 2 1/8 |
| 470 | 500C471T350AH2B | 253.0 | 2.40 | 1 3/8 x 2 5/8 |
| 630 | 500C631T350AB2B | 190.0 | 3.00 | 1 3/8 x 3 1/8 |
| 720 | 500C721T350EA2B | 177.0 | 3.10 | 1 3/4 x 2 1/8 |

| Cap. (µF) | Catalog Part Number | ESR Max. @ 25 °C 120 Hz (mΩ) | Ripple Max. @ 85°C 120 Hz (A) | Nominal Size D x L (inches) |
|--------------------------------|---------------------|------------------------------|-------------------------------|-----------------------------|
| 350 Vdc (400 Vdc Surge) | | | | |
| 770 | 500C771T350EH2B | 162.0 | 3.50 | 1 3/4 x 2 5/8 |
| 790 | 500C791T350AJ2B | 153.0 | 3.50 | 1 3/8 x 3 5/8 |
| 790 | 500C791T350BA2B | 168.0 | 3.50 | 2 x 2 1/8 |
| 950 | 500C951T350AC2B | 127.0 | 4.00 | 1 3/8 x 4 1/8 |
| 970 | 500C971T350BH2B | 132.0 | 4.20 | 2 x 2 5/8 |
| 990 | 500C991T350EB2B | 125.0 | 4.30 | 1 3/4 x 3 1/8 |
| 1100 | 500C112T350AD2B | 110.0 | 4.50 | 1 3/8 x 4 5/8 |
| 1300 | 500C132T350AE2B | 96.3 | 5.00 | 1 3/8 x 5 1/8 |
| 1300 | 500C132T350EJ2B | 97.3 | 5.10 | 1 3/4 x 3 5/8 |
| 1300 | 500C132T350BB2B | 101.0 | 5.10 | 2 x 3 1/8 |
| 1400 | 500C142T350AF2B | 85.9 | 5.50 | 1 3/8 x 5 5/8 |
| 1500 | 500C152T350CH2B | 86.9 | 6.00 | 2 1/2 x 2 5/8 |
| 1600 | 500C162T350EC2B | 79.9 | 5.90 | 1 3/4 x 4 1/8 |
| 1600 | 500C162T350BJ2B | 79.2 | 6.10 | 2 x 3 5/8 |
| 1800 | 500C182T350ED2B | 67.8 | 6.60 | 1 3/4 x 4 5/8 |
| 2000 | 500C202T350BC2B | 65.1 | 7.00 | 2 x 4 1/8 |
| 2100 | 500C212T350EE2B | 59.1 | 7.40 | 1 3/4 x 5 1/8 |
| 2100 | 500C212T350CB2B | 61.0 | 7.60 | 2 1/2 x 3 1/8 |
| 2300 | 500C232T350BD2B | 55.4 | 8.00 | 2 x 4 5/8 |
| 2400 | 500C242T350EF2B | 52.4 | 8.10 | 1 3/4 x 5 5/8 |
| 2700 | 500C272T350BE2B | 48.3 | 8.80 | 2 x 5 1/8 |
| 2700 | 500C272T350CJ2B | 48.5 | 8.90 | 2 1/2 x 3 5/8 |
| 2900 | 500C292T350DB2B | 54.0 | 9.00 | 3 x 3 1/8 |
| 3100 | 500C312T350BF2B | 42.8 | 9.70 | 2 x 5 5/8 |
| 3300 | 500C332T350CC2B | 39.9 | 10.30 | 2 1/2 x 4 1/8 |
| 3700 | 500C372T350DJ2B | 41.7 | 10.80 | 3 x 3 5/8 |
| 3900 | 500C392T350CD2B | 34.0 | 11.60 | 2 1/2 x 4 5/8 |
| 4500 | 500C452T350CE2B | 29.6 | 12.80 | 2 1/2 x 5 1/8 |
| 4600 | 500C462T350DC2B | 34.7 | 12.30 | 3 x 4 1/8 |
| 5100 | 500C512T350CF2B | 26.2 | 14.10 | 2 1/2 x 5 5/8 |
| 5400 | 500C542T350DD2B | 29.6 | 13.90 | 3 x 4 5/8 |
| 6200 | 500C622T350DE2B | 25.8 | 15.30 | 3 x 5 1/8 |
| 6400 | 500C642T350FC2D | 29.9 | 14.60 | 3 1/2 x 4 1/8 |
| 7000 | 500C702T350DF2B | 22.9 | 16.70 | 3 x 5 5/8 |
| 7500 | 500C752T350DP2B | 21.7 | 17.40 | 3 x 5 7/8 |
| 7500 | 500C752T350FD2D | 25.7 | 16.30 | 3 1/2 x 4 5/8 |
| 8700 | 500C872T350FE2D | 22.5 | 18.00 | 3 1/2 x 5 1/8 |
| 9800 | 500C982T350FF2D | 20.0 | 19.60 | 3 1/2 x 5 5/8 |
| 10000 | 500C103T350DN2B | 17.1 | 21.80 | 3 x 7 5/8 |
| 10000 | 500C103T350FP2D | 18.9 | 20.40 | 3 1/2 x 5 7/8 |
| 12000 | 500C123T350DG2B | 14.2 | 24.30 | 3 x 8 5/8 |
| 15000 | 500C153T350FN2D | 14.9 | 25.40 | 3 1/2 x 7 5/8 |
| 17000 | 500C173T350FG2D | 12.4 | 28.30 | 3 1/2 x 8 5/8 |

Type 500C 95 °C Long Life, Screw Terminal, Aluminum

Long Life, High Capacitance Screw Terminal Type

| Cap. (µF) | Catalog Part Number | ESR Max. @ 25 °C 120 Hz (mΩ) | Ripple Max. @ 85°C 120 Hz (A) | Nominal Size D x L (inches) |
|--------------------------------|---------------------|------------------------------|-------------------------------|-----------------------------|
| 400 Vdc (450 Vdc Surge) | | | | |
| 160 | 500C161T400AK2B | 652.0 | 1.30 | 1 3/8 x 1 5/8 |
| 250 | 500C251T400AA2B | 408.0 | 1.80 | 1 3/8 x 2 1/8 |
| 380 | 500C381T400AH2B | 273.0 | 2.30 | 1 3/8 x 2 5/8 |
| 500 | 500C501T400AB2B | 205.0 | 2.90 | 1 3/8 x 3 1/8 |
| 570 | 500C571T400EA2B | 189.0 | 3.00 | 1 3/4 x 2 1/8 |
| 610 | 500C611T400EH2B | 174.0 | 3.40 | 1 3/4 x 2 5/8 |
| 630 | 500C631T400AJ2B | 164.0 | 3.40 | 1 3/8 x 3 5/8 |
| 630 | 500C631T400BA2B | 179.0 | 3.40 | 2 x 2 1/8 |
| 750 | 500C751T400AC2B | 137.0 | 3.90 | 1 3/8 x 4 1/8 |
| 780 | 500C781T400BH2B | 142.0 | 4.10 | 2 x 2 5/8 |
| 790 | 500C791T400EB2B | 134.0 | 4.10 | 1 3/4 x 3 1/8 |
| 880 | 500C881T400AD2B | 118.0 | 4.40 | 1 3/8 x 4 5/8 |
| 1000 | 500C102T400AE2B | 104.0 | 4.90 | 1 3/8 x 5 1/8 |
| 1000 | 500C102T400EJ2B | 105.0 | 4.90 | 1 3/4 x 3 5/8 |
| 1000 | 500C102T400BB2B | 109.0 | 5.00 | 2 x 3 1/8 |
| 1100 | 500C112T400AF2B | 92.4 | 5.30 | 1 3/8 x 5 5/8 |
| 1200 | 500C122T400EC2B | 85.8 | 5.70 | 1 3/4 x 4 1/8 |
| 1200 | 500C122T400CH2B | 93.1 | 5.80 | 2 1/2 x 2 5/8 |
| 1300 | 500C132T400BJ2B | 85.0 | 5.90 | 2 x 3 5/8 |
| 1500 | 500C152T400ED2B | 72.9 | 6.40 | 1 3/4 x 4 5/8 |
| 1600 | 500C162T400BC2B | 69.8 | 6.80 | 2 x 4 1/8 |
| 1700 | 500C172T400EE2B | 63.4 | 7.10 | 1 3/4 x 5 1/8 |
| 1700 | 500C172T400CB2B | 65.3 | 7.30 | 2 1/2 x 3 1/8 |
| 1900 | 500C192T400EF2B | 56.2 | 7.80 | 1 3/4 x 5 5/8 |
| 1900 | 500C192T400BD2B | 59.3 | 7.70 | 2 x 4 5/8 |
| 2100 | 500C212T400BE2B | 51.7 | 8.50 | 2 x 5 1/8 |
| 2100 | 500C212T400CJ2B | 52.0 | 8.60 | 2 1/2 x 3 5/8 |
| 2300 | 500C232T400DB2B | 57.5 | 8.80 | 3 x 3 1/8 |
| 2400 | 500C242T400BF2B | 45.9 | 9.30 | 2 x 5 5/8 |
| 2600 | 500C262T400CC2B | 42.8 | 9.90 | 2 1/2 x 4 1/8 |
| 3000 | 500C302T400DJ2B | 44.9 | 10.40 | 3 x 3 5/8 |
| 3100 | 500C312T400CD2B | 35.6 | 11.30 | 2 1/2 x 4 5/8 |
| 3500 | 500C352T400CE2B | 31.7 | 12.40 | 2 1/2 x 5 1/8 |
| 3600 | 500C362T400DC2B | 37.0 | 11.90 | 3 x 4 1/8 |
| 4000 | 500C402T400CF2B | 31.5 | 12.80 | 2 1/2 x 5 5/8 |
| 4300 | 500C432T400DD2B | 28.1 | 14.20 | 3 x 4 5/8 |
| 4900 | 500C492T400DE2B | 27.4 | 14.80 | 3 x 5 1/8 |
| 5100 | 500C512T400FC2D | 31.9 | 14.10 | 3 1/2 x 4 1/8 |
| 5600 | 500C562T400DF2B | 24.4 | 16.20 | 3 x 5 5/8 |
| 5900 | 500C592T400DP2B | 23.1 | 16.90 | 3 x 5 7/8 |
| 6000 | 500C602T400FD2D | 27.4 | 15.80 | 3 1/2 x 4 5/8 |
| 6900 | 500C692T400FE2D | 23.9 | 17.50 | 3 1/2 x 5 1/8 |
| 7800 | 500C782T400FF2D | 21.2 | 19.00 | 3 1/2 x 5 5/8 |

| Cap. (µF) | Catalog Part Number | ESR Max. @ 25 °C 120 Hz (mΩ) | Ripple Max. @ 85°C 120 Hz (A) | Nominal Size D x L (inches) |
|--------------------------------|---------------------|------------------------------|-------------------------------|-----------------------------|
| 8200 | 500C822T400DN2B | 18.2 | 21.20 | 3 x 7 5/8 |
| 8300 | 500C832T400FP2D | 20.1 | 19.80 | 3 1/2 x 5 7/8 |
| 9500 | 500C952T400DG2B | 15.1 | 23.60 | 3 x 8 5/8 |
| 11000 | 500C113T400FN2D | 15.8 | 24.70 | 3 1/2 x 7 5/8 |
| 13000 | 500C133T400FG2D | 13.1 | 27.50 | 3 1/2 x 8 5/8 |
| 450 Vdc (500 Vdc Surge) | | | | |
| 140 | 500C141T450AK2B | 797.0 | 1.10 | 1 3/8 x 1 5/8 |
| 220 | 500C221T450AA2B | 438.0 | 1.70 | 1 3/8 x 2 1/8 |
| 330 | 500C331T450AH2B | 337.0 | 2.10 | 1 3/8 x 2 5/8 |
| 420 | 500C421T450EA2B | 264.0 | 2.60 | 1 3/4 x 2 1/8 |
| 440 | 500C441T450AB2B | 253.0 | 2.60 | 1 3/8 x 3 1/8 |
| 520 | 500C521T450EH2B | 213.0 | 3.10 | 1 3/4 x 2 5/8 |
| 550 | 500C551T450AJ2B | 203.0 | 3.10 | 1 3/8 x 3 5/8 |
| 550 | 500C551T450BA2B | 228.0 | 3.00 | 2 x 2 1/8 |
| 660 | 500C661T450AC2B | 169.0 | 3.50 | 1 3/8 x 4 1/8 |
| 670 | 500C671T450EB2B | 165.0 | 3.70 | 1 3/4 x 3 1/8 |
| 680 | 500C681T450BH2B | 178.0 | 3.60 | 2 x 2 5/8 |
| 760 | 500C761T450AD2B | 146.0 | 3.90 | 1 3/8 x 4 5/8 |
| 870 | 500C871T450AE2B | 128.0 | 4.40 | 1 3/8 x 5 1/8 |
| 870 | 500C871T450EJ2B | 131.0 | 4.40 | 1 3/4 x 3 5/8 |
| 870 | 500C871T450BB2B | 137.0 | 4.40 | 2 x 3 1/8 |
| 980 | 500C981T450AF2B | 114.0 | 4.80 | 1 3/8 x 5 5/8 |
| 1100 | 500C112T450EC2B | 107.0 | 5.10 | 1 3/4 x 4 1/8 |
| 1100 | 500C112T450BJ2B | 109.0 | 5.20 | 2 x 3 5/8 |
| 1100 | 500C112T450CH2B | 116.0 | 5.20 | 2 1/2 x 2 5/8 |
| 1300 | 500C132T450ED2B | 91.1 | 5.70 | 1 3/4 x 4 5/8 |
| 1400 | 500C142T450EE2B | 79.2 | 6.40 | 1 3/4 x 5 1/8 |
| 1400 | 500C142T450BC2B | 89.5 | 6.00 | 2 x 4 1/8 |
| 1500 | 500C152T450CB2B | 81.1 | 6.60 | 2 1/2 x 3 1/8 |
| 1600 | 500C162T450EF2B | 70.2 | 7.00 | 1 3/4 x 5 5/8 |
| 1600 | 500C162T450BD2B | 76.0 | 6.80 | 2 x 4 5/8 |
| 1900 | 500C192T450BE2B | 66.1 | 7.50 | 2 x 5 1/8 |
| 1900 | 500C192T450CJ2B | 66.5 | 7.60 | 2 1/2 x 3 5/8 |
| 2100 | 500C212T450BF2B | 58.6 | 8.30 | 2 x 5 5/8 |
| 2100 | 500C212T450DB2B | 63.8 | 8.30 | 3 x 3 1/8 |
| 2400 | 500C242T450CC2B | 54.7 | 8.80 | 2 1/2 x 4 1/8 |
| 2700 | 500C272T450DJ2B | 49.8 | 9.90 | 3 x 3 5/8 |
| 2800 | 500C282T450CD2B | 46.4 | 9.90 | 2 1/2 x 4 5/8 |
| 3200 | 500C322T450CE2B | 40.4 | 11.00 | 2 1/2 x 5 1/8 |
| 3300 | 500C332T450DC2B | 38.2 | 11.80 | 3 x 4 1/8 |
| 3600 | 500C362T450CF2B | 35.4 | 12.10 | 2 1/2 x 5 5/8 |
| 3900 | 500C392T450DD2B | 35.7 | 12.60 | 3 x 4 5/8 |
| 4500 | 500C452T450DE2B | 30.9 | 14.00 | 3 x 5 1/8 |
| 4600 | 500C462T450FC2D | 30.3 | 14.50 | 3 1/2 x 4 1/8 |

Type 500C 95 °C Long Life, Screw Terminal, Aluminum

Long Life, High Capacitance Screw Terminal Type

| Cap. (µF) | Catalog Part Number | ESR Max. @ 25 °C 120 Hz (mΩ) | Ripple Max. @ 85°C 120 Hz (A) | Nominal Size D x L (inches) |
|--------------------------------|---------------------|------------------------------|-------------------------------|-----------------------------|
| 450 Vdc (500 Vdc Surge) | | | | |
| 5100 | 500C512T450DF2B | 27.4 | 15.30 | 3 x 5 5/8 |
| 5400 | 500C542T450DP2B | 26.0 | 15.90 | 3 x 5 7/8 |
| 5400 | 500C542T450FD2D | 25.7 | 16.30 | 3 1/2 x 4 5/8 |
| 6300 | 500C632T450FE2D | 22.4 | 18.00 | 3 1/2 x 5 1/8 |
| 7100 | 500C712T450FF2D | 19.9 | 19.70 | 3 1/2 x 5 5/8 |
| 7500 | 500C752T450FP2D | 18.8 | 20.50 | 3 1/2 x 5 7/8 |
| 7500 | 500C752T450DN2B | 20.3 | 20.00 | 3 x 7 5/8 |
| 8700 | 500C872T450DG2B | 16.8 | 22.40 | 3 x 8 5/8 |
| 9700 | 500C972T450FN2D | 15.1 | 25.20 | 3 1/2 x 7 5/8 |
| 11000 | 500C113T450FG2D | 12.7 | 28.00 | 3 1/2 x 8 5/8 |
| 500 Vdc (550 Vdc Surge) | | | | |
| 100 | 500C101T500AK2B | 1224.0 | 0.90 | 1 3/8 x 1 5/8 |
| 170 | 500C171T500AA2B | 722.0 | 1.30 | 1 3/8 x 2 1/8 |
| 230 | 500C231T500AH2B | 546.0 | 1.70 | 1 3/8 x 2 5/8 |
| 260 | 500C261T500EA2B | 498.0 | 1.90 | 1 3/4 x 2 1/8 |
| 310 | 500C311T500AB2B | 410.0 | 2.00 | 1 3/8 x 3 1/8 |
| 320 | 500C321T500BA2B | 393.0 | 2.30 | 2 x 2 1/8 |
| 370 | 500C371T500EH2B | 347.0 | 2.40 | 1 3/4 x 2 5/8 |
| 380 | 500C381T500AJ2B | 328.0 | 2.40 | 1 3/8 x 3 5/8 |
| 460 | 500C461T500AC2B | 293.0 | 2.70 | 1 3/8 x 4 1/8 |
| 470 | 500C471T500BH2B | 274.0 | 2.90 | 2 x 2 5/8 |
| 480 | 500C481T500EB2B | 265.0 | 2.90 | 1 3/4 x 3 1/8 |
| 530 | 500C531T500AD2B | 261.0 | 2.90 | 1 3/8 x 4 5/8 |
| 610 | 500C611T500AE2B | 231.0 | 3.30 | 1 3/8 x 5 1/8 |
| 620 | 500C621T500EJ2B | 202.0 | 3.50 | 1 3/4 x 3 5/8 |
| 650 | 500C651T500BB2B | 200.0 | 3.70 | 2 x 3 1/8 |
| 690 | 500C691T500AF2B | 195.0 | 3.70 | 1 3/8 x 5 5/8 |
| 760 | 500C761T500EC2B | 169.0 | 4.00 | 1 3/4 x 4 1/8 |
| 770 | 500C771T500CH2B | 171.0 | 4.30 | 2 1/2 x 2 5/8 |
| 840 | 500C841T500BJ2B | 156.0 | 4.40 | 2 x 3 5/8 |
| 890 | 500C891T500ED2B | 143.0 | 4.60 | 1 3/4 x 4 5/8 |
| 960 | 500C961T500BC2B | 136.0 | 4.90 | 2 x 4 1/8 |
| 1000 | 500C102T500EE2B | 125.0 | 5.10 | 1 3/4 x 5 1/8 |
| 1100 | 500C112T500BD2B | 115.0 | 5.50 | 2 x 4 5/8 |
| 1100 | 500C112T500CB2B | 122.0 | 5.40 | 2 1/2 x 3 1/8 |

| Cap. (µF) | Catalog Part Number | ESR Max. @ 25 °C 120 Hz (mΩ) | Ripple Max. @ 85°C 120 Hz (A) | Nominal Size D x L (inches) |
|--------------------------------|---------------------|------------------------------|-------------------------------|-----------------------------|
| 500 Vdc (550 Vdc Surge) | | | | |
| 1200 | 500C122T500EF2B | 110.0 | 5.60 | 1 3/4 x 5 5/8 |
| 1300 | 500C132T500BE2B | 100.0 | 6.10 | 2 x 5 1/8 |
| 1400 | 500C142T500CJ2B | 95.1 | 6.40 | 2 1/2 x 3 5/8 |
| 1500 | 500C152T500BF2B | 88.9 | 6.70 | 2 x 5 5/8 |
| 1600 | 500C162T500DB2B | 86.4 | 7.10 | 3 x 3 1/8 |
| 1700 | 500C172T500CC2B | 78.1 | 7.40 | 2 1/2 x 4 1/8 |
| 2000 | 500C202T500CD2B | 66.3 | 8.30 | 2 1/2 x 4 5/8 |
| 2100 | 500C212T500DJ2B | 67.4 | 8.50 | 3 x 3 5/8 |
| 2200 | 500C222T500CE2B | 61.1 | 8.90 | 2 1/2 x 5 1/8 |
| 2400 | 500C242T500CF2B | 54.7 | 9.70 | 2 1/2 x 5 5/8 |
| 2400 | 500C242T500DC2B | 55.4 | 9.80 | 3 x 4 1/8 |
| 2800 | 500C282T500DD2B | 48.1 | 10.90 | 3 x 4 5/8 |
| 3300 | 500C332T500DE2B | 43.1 | 11.80 | 3 x 5 1/8 |
| 3400 | 500C342T500FC2D | 40.1 | 12.60 | 3 1/2 x 4 1/8 |
| 3700 | 500C372T500DF2B | 37.5 | 13.10 | 3 x 5 5/8 |
| 3900 | 500C392T500DP2B | 35.5 | 13.60 | 3 x 5 7/8 |
| 4000 | 500C402T500FD2D | 34.1 | 14.20 | 3 1/2 x 4 5/8 |
| 4600 | 500C462T500FE2D | 30.0 | 15.60 | 3 1/2 x 5 1/8 |
| 5200 | 500C522T500FF2D | 28.0 | 16.60 | 3 1/2 x 5 5/8 |
| 5400 | 500C542T500DN2B | 27.9 | 17.10 | 3 x 7 5/8 |
| 5500 | 500C552T500FP2D | 26.0 | 17.40 | 3 1/2 x 5 7/8 |
| 6300 | 500C632T500DG2B | 23.1 | 19.10 | 3 x 8 5/8 |
| 7600 | 500C762T500FN2D | 20.5 | 21.80 | 3 1/2 x 7 5/8 |
| 8800 | 500C882T500FG2D | 16.7 | 24.40 | 3 1/2 x 8 5/8 |
| 550 Vdc (600 Vdc Surge) | | | | |
| 1400 | 500C142T550CC2B | 170.5 | 4.90 | 2 1/2 x 4 1/8 |
| 1700 | 500C172T550CD2B | 132.6 | 5.90 | 2 1/2 x 4 5/8 |
| 1900 | 500C192T550CE2B | 111.7 | 6.80 | 2 1/2 x 5.125 |
| 2200 | 500C222T550DC2B | 90.4 | 7.80 | 3 x 4 1/8 |
| 2300 | 500C232T550CF2B | 86.5 | 7.80 | 2 1/2 x 5 5/8 |
| 2500 | 500C252T550DD2B | 79.6 | 8.40 | 3 x 4 5/8 |
| 2900 | 500C292T550DE2B | 64.0 | 9.70 | 3 x 5 1/8 |
| 3400 | 500C342T550DF2F | 54.6 | 10.90 | 3 x 5 5/8 |
| 3700 | 500C372T550DP2B | 50.2 | 12.24 | 3 x 5 7/8 |
| 5100 | 500C512T550DN2B | 36.4 | 16.22 | 3 x 7 5/8 |

Type 500C 95 °C Long Life, Screw Terminal, Aluminum

Long Life, High Capacitance Screw Terminal Type

Typical Performance Curves

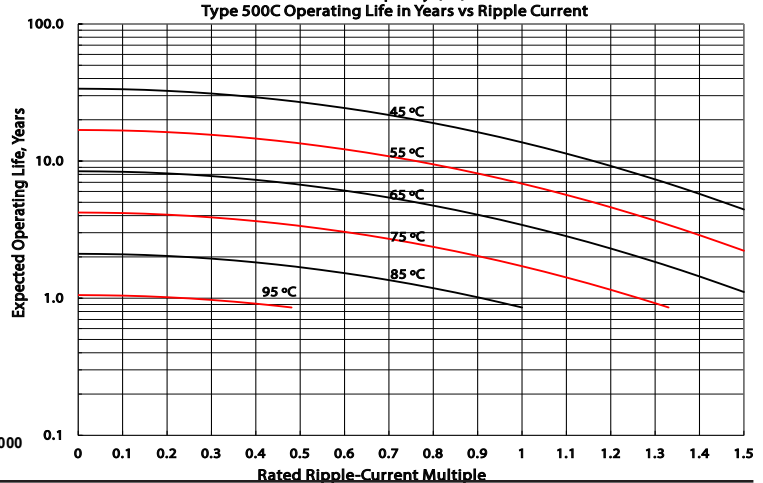
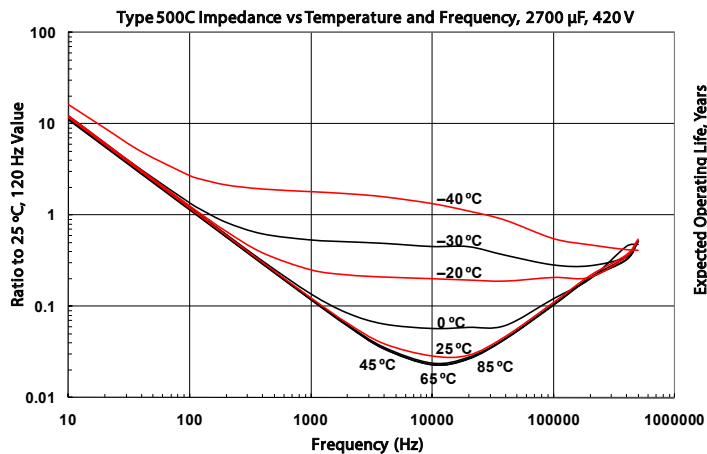
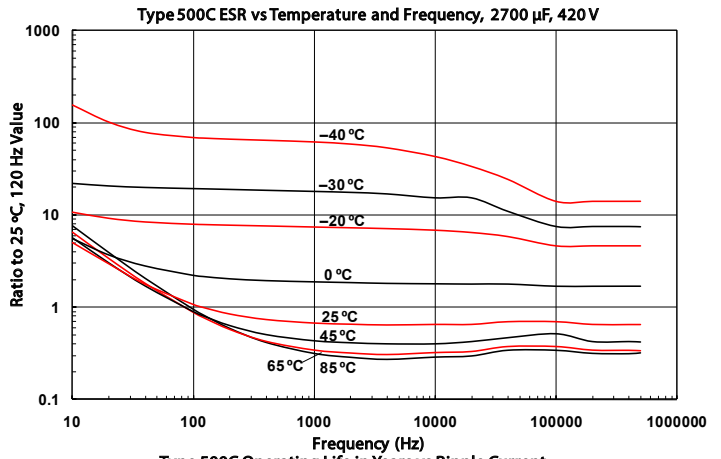
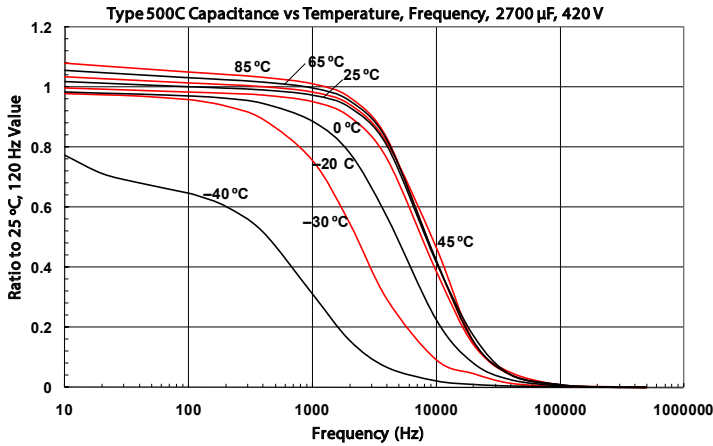
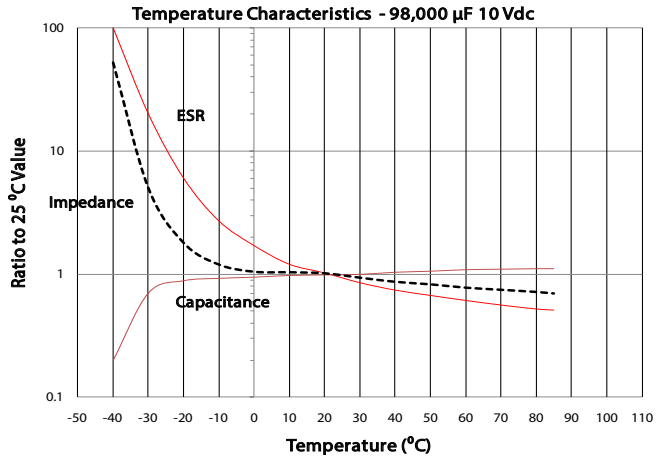
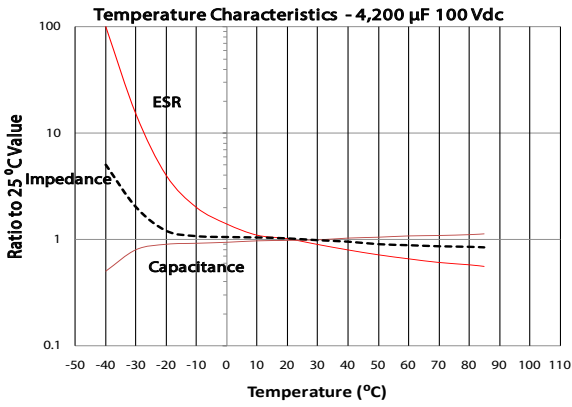
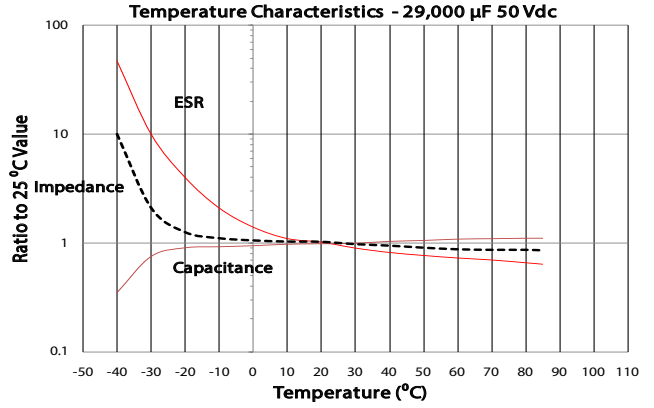
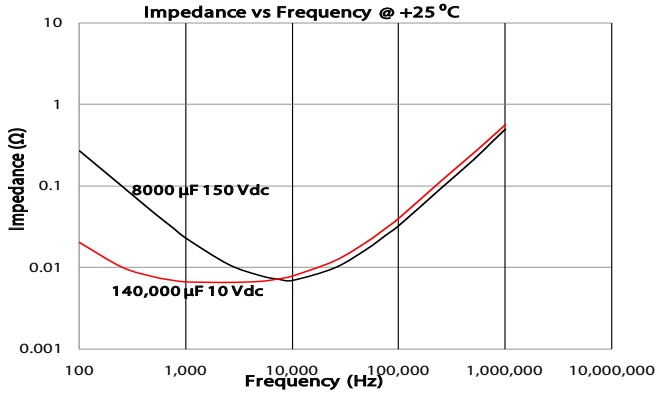

Notice and Disclaimer: All product drawings, descriptions, specifications, statements, information and data (collectively, the "Information") in this datasheet or other publication are subject to change. The customer is responsible for checking, confirming and verifying the extent to which the Information contained in this datasheet or other publication is applicable to an order at the time the order is placed. All Information given herein is believed to be accurate and reliable, but it is presented without any guarantee, warranty, representation or responsibility of any kind, expressed or implied. Statements of suitability for certain applications are based on the knowledge that the Cornell Dubilier company providing such statements ("Cornell Dubilier") has of operating conditions that such Cornell Dubilier company regards as typical for such applications, but are not intended to constitute any guarantee, warranty or representation regarding any such matter – and Cornell Dubilier specifically and expressly disclaims any guarantee, warranty or representation concerning the suitability for a specific customer application, use, storage, transportation, or operating environment. The Information is intended for use only by customers who have the requisite experience and capability to determine the correct products for their application. Any technical advice inferred from this Information or otherwise provided by Cornell Dubilier with reference to the use of any Cornell Dubilier products is given gratis (unless otherwise specified by Cornell Dubilier), and Cornell Dubilier assumes no obligation or liability for the advice given or results obtained. Although Cornell Dubilier strives to apply the most stringent quality and safety standards regarding the design and manufacturing of its products, in light of the current state of the art, isolated component failures may still occur. Accordingly, customer applications which require a high degree of reliability or safety should employ suitable designs or other safeguards (such as installation of protective circuitry or redundancies or other appropriate protective measures) in order to ensure that the failure of an electrical component does not result in a risk of personal injury or property damage. Although all product-related warnings, cautions and notes must be observed, the customer should not assume that all safety measures are indicated in such warnings, cautions and notes, or that other safety measures may not be required.



Компания «ЭлектроПласт» предлагает заключение долгосрочных отношений при поставках импортных электронных компонентов на взаимовыгодных условиях!

Наши преимущества:

- Оперативные поставки широкого спектра электронных компонентов отечественного и импортного производства напрямую от производителей и с крупнейших мировых складов;
- Поставка более 17-ти миллионов наименований электронных компонентов;
- Поставка сложных, дефицитных, либо снятых с производства позиций;
- Оперативные сроки поставки под заказ (от 5 рабочих дней);
- Экспресс доставка в любую точку России;
- Техническая поддержка проекта, помощь в подборе аналогов, поставка прототипов;
- Система менеджмента качества сертифицирована по Международному стандарту ISO 9001;
- Лицензия ФСБ на осуществление работ с использованием сведений, составляющих государственную тайну;
- Поставка специализированных компонентов (Xilinx, Altera, Analog Devices, Intersil, Interpoint, Microsemi, Aeroflex, Peregrine, Syfer, Eurofarad, Texas Instrument, Miteq, Cobham, E2V, MA-COM, Hittite, Mini-Circuits, General Dynamics и др.);

Помимо этого, одним из направлений компании «ЭлектроПласт» является направление «Источники питания». Мы предлагаем Вам помощь Конструкторского отдела:

- Подбор оптимального решения, техническое обоснование при выборе компонента;
- Подбор аналогов;
- Консультации по применению компонента;
- Поставка образцов и прототипов;
- Техническая поддержка проекта;
- Защита от снятия компонента с производства.



Как с нами связаться

Телефон: 8 (812) 309 58 32 (многоканальный)

Факс: 8 (812) 320-02-42

Электронная почта: org@eplast1.ru

Адрес: 198099, г. Санкт-Петербург, ул. Калинина, дом 2, корпус 4, литера А.