

PUSHBUTTON SWITCHES

C

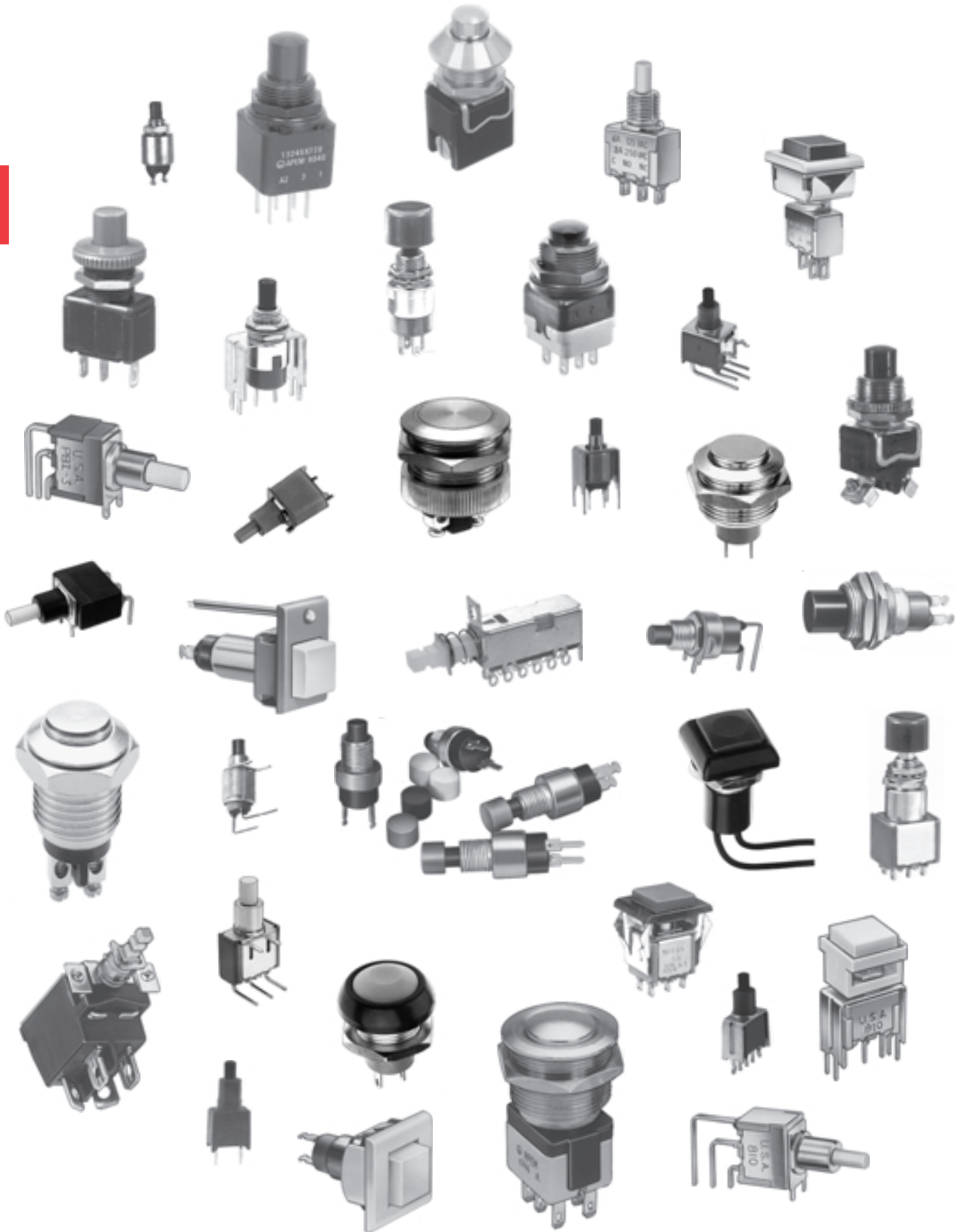

SPECIFICATIONS SUBJECT TO CHANGE WITHOUT NOTICE

PUSHBUTTON SWITCHES

PUSHBUTTON SWITCH SELECTION GUIDE: This catalog contains an extensive variety of pushbutton switches with numerous options and accessories. To facilitate easy selection of the desired switch for your application, this guide lists the various Series with some key selection parameters. Note - new Series added in this catalog are indicated below, however many new models and options have also been added to other listed Series.

SPECIFICATIONS SUBJECT TO CHANGE WITHOUT NOTICE

SERIES	SIZE	RATINGS (Max. in bold)	POLES	ILLUMINATED	SMT MOUNT	PANEL MOUNT	P. C. MOUNT	UL	CSA	VDE	WASHABLE	ESD PROTECTION	PAGE(S)
TP	TINY	0.4VA 20V	SP		X						X	X	C2-C5
ZP New!	TINY	500mA 48V 0.4VA 20V	SP			X	X						C6-C8
TP	TINY	500mA 48V 0.4VA 20V	SP,DP				X				X		C9-C12
9000	SUB-MINI.	100mA 30VDC	SP			X	X						C13-C17
9000	MINIATURE	600mA 125VAC 1A 30VDC 100mA 30VDC	SP				X						C18-C21
10400	MINIATURE	3 A 110VAC or 24VDC 2A 220VAC	SP,DP			X							C22-C23
300 & 400	MINIATURE	3A 125VAC or 28VDC 1.5A 250VAC 0.4VA 20V	SP	X		X	X	X					C24-C30
MPB	MINIATURE	300mA 125VAC	SP			X							C31
IP	MINIATURE	500mA 48VAC 200mA 50VDC or 250VAC	SP	X		X					X		C32-C36
IB & IS New!	MINIATURE	400mA 32VAC 100mA- 50VDC or 125mA 125VAC				X					X		C37-C39
SP	MINIATURE	1A 120VAC or 30VDC 100mA 30VDC	SP,DP			X	X	X				X	C40-C43
18000	MINIATURE	1A 120VAC or 30VDC	SP,DP			X	X						C44-C50
8000	MINIATURE	6A 125VAC 3A 250VAC 4A 30VDC 0.4VA 20V	SP,DP			X	X	X					C51-C54
800	MINIATURE	6A 125VAC 3A 250VAC 7A 30VDC 0.4VA 20V	SP,DP	X		X	X	X	X				C55-C64
PB	MINIATURE	6A 125VAC 3A 250VAC 7A 30VDC 0.4VA 20V	SP	X		X	X	X	X				C65-C73
13000	MINIATURE	4A 125VAC 2A 250VAC 4A 30VDC 100mA 30V	SP,DP			X	X						C74-C78
13000X778	MINIATURE	4A 125VAC 2A 250VAC 4A 28VDC 300mA 30VDC	DP			X	X						C79-C81
1200	STANDARD	8A 125VAC 4A 250VAC 4A 24VDC	SP			X		X	X	X			C82-C84
1200M&MR	STANDARD	8A 125VAC 4A 250VAC 4A 24VDC	SP			X		X	X				C85-C86
4700&4800	STANDARD	6A 125VAC 3A 250VAC	SP,DP			X		X	X	X			C87-C88
MD	STANDARD	200mA 30VDC	SP,DP,4P			X	X						C89-C91
MD2	STANDARD	15A 125VAC 10A 250VAC TV-5	SP			X							C92
1400N New!	STANDARD	4A 125VAC 2A 250VAC	SP			X							C93
AV	STANDARD	SEE INDEX ON PAGE C96 FOR AV SERIES PUSHBUTTON SWITCHES.											C94-C116



TP SERIES - SMT WASHABLE TINY PUSHBUTTON SWITCHES

DESIGNED EXCLUSIVELY FOR SURFACE MOUNTING

SMT TP Series switches incorporate many desirable features that include:

- **Tape & reel packaging**
This type of packaging is recommended for:
 - economy
 - suitability for automated placement
 - handling of large quantities of components per packaging unit
 - positive component positioning
 - protection of terminals against damage during handling
 - high static resistance
- **Reflow solderable**
 - High temperature plastic materials
 - Tin plated grounding brackets
 - Tin-lead alloy over nickel terminal plating
 - Terminals turned outward to prevent the shadow effect in infrared soldering and to permit visual inspection of the solder joints
 - .021" (0.55mm) air gap between p.c. board and switch case
 - End stackable with .400" (10.16mm) pitch
 - Available with positioning pins to assure correct switch orientation during the reflow process and provide additional mechanical integrity
- **Protected against electrostatic discharges (ESD) up to 10 KV.**
- **Washable**
Switches are designed to withstand cleaning processes, including hot water under pressure.

Surface mount devices (SMD) are subject to more stringent constraints of temperature, solderability, sealing and space savings than through-hole components.

To meet these requirements, APEM has designed a family of tiny surface mount switches that include TL Series toggle switches, TP Series pushbutton switches, TR Series rocker switches & TG Series slide switches. See toggle, rocker & slide switch sections of catalog for TL, TR & TG Series respectively.



SPECIFICATIONS SUBJECT TO CHANGE WITHOUT NOTICE

TP SERIES - SMT WASHABLE TINY PUSHBUTTON SWITCHES

ELECTRICAL SPECIFICATIONS

Contact ratings (resistive lds.):	0.4 VA at 20 V max. (AC or DC)
Minimum load:	10 mA at 50 mV or 10µA at 5 VD
Initial contact resistance:	50 milliohms maximum
Insulation resistance:	1000 MΩ min. at 500 VDC
Dielectric strength:	1000 V rms between terminals & frame. 500 V rms between terminals
Electrical life (at full load):	60,000 cycles
Static resistance:	10 KV (Schaffner equipment)

GENERAL SPECIFICATIONS

Travel:	ON-MOM .039" (1mm), OFF-MOM. .031" (0.8mm)
Operating temperature range:	-40°C to +85°C
Moisture resistance:	21 days per IEC 512-6 test 11c
Vibration resistance:	10-500 Hz/10g per IEC 512-4 test 6d
Shock resistance:	50 g per IEC 512-4 test 6c

MATERIALS

Case:	High temperature plastic UL94V-0
Actuator:	High temperature plastic UL94V-0
Grounding brackets:	Tin plated steel (includes positioning pins)
Contacts:	Gold plated brass
Terminals:	Brass with tin-lead alloy over nickel plate
Terminal seal:	Epoxy

SOLDERING AND CLEANING

Reflow soldering:	Infrared, vapor phase and infrared convection
Washable:	Per IEA-RS448-2: water and detergent - preferred. Solvents.

PACKAGING

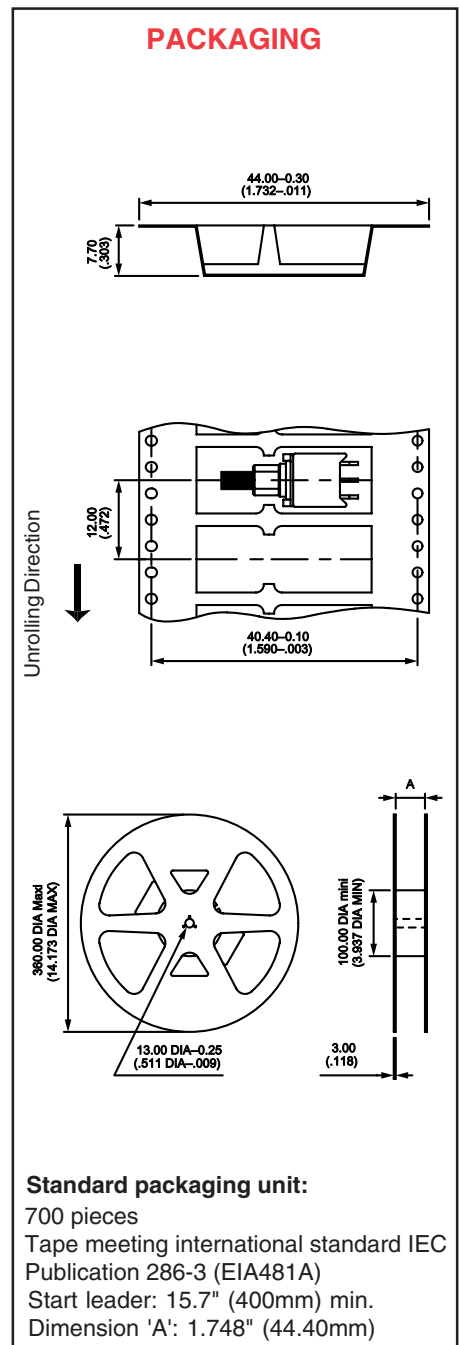

SPECIFICATIONS SUBJECT TO CHANGE WITHOUT NOTICE



C

TP SERIES - SMT WASHABLE TINY PUSHBUTTON SWITCHES

Single pole momentary pushbutton switches



MODEL NO.	CIRCUIT	
TP32WS83500	ON	MOM
TP33WS83500	OFF	MOM

Handle position:  

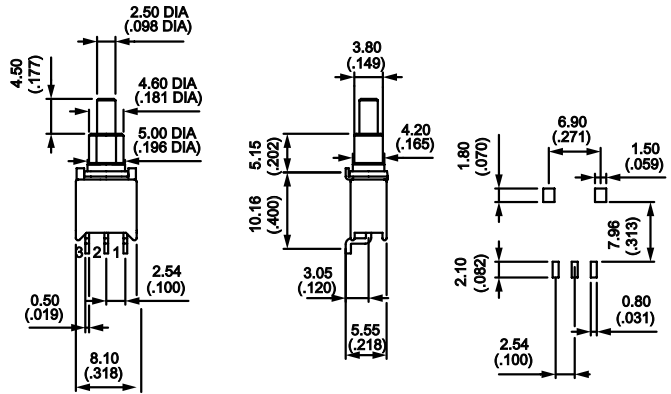

Function 2 shown



Single pole momentary pushbutton switches with positioning pins



MODEL NO.	CIRCUIT	
TP32WS83565	ON	MOM
TP33WS83565	OFF	MOM

Handle position:  

Function 2 shown

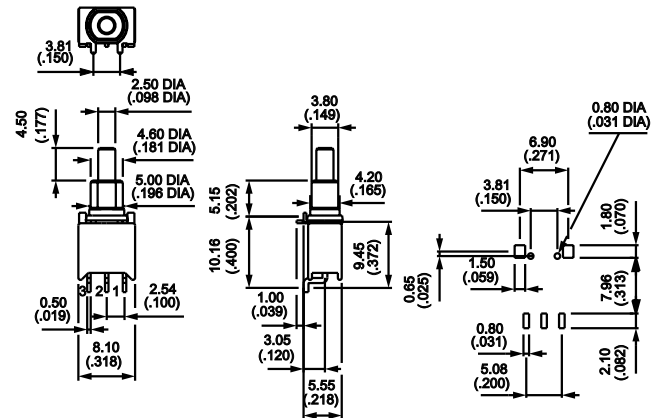

SWITCH ACTION

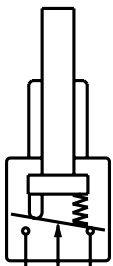

3 2 1

Function 2

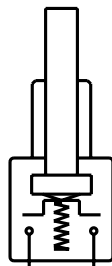

1 3

Function 3

P.C. BOARD DIMENSIONS

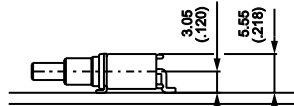

LED INDICATOR IN TINY PUSHBUTTON PKG.

ELECTRICAL SPECIFICATIONS

Forward voltage:	Red;
	3.0 volts at 10 milliamps (2V typical)
	Green;
	3.0 volts at 20 milliamps (2.2V typical)
	Yellow;
	3.0 volts at 10 milliamps (2.1V typical)
Reverse voltage:	5.0 volts minimum
Viewing angle (total):	90°
Wavelength:	Red; 635 nm
	Green; 565 nm
	Yellow; 585 nm

PACKAGING

Tape & reel



MODEL NO.	COLOR
TV01WS00100	Red
TV02WS00100	Green
TV03WS00100	Yellow

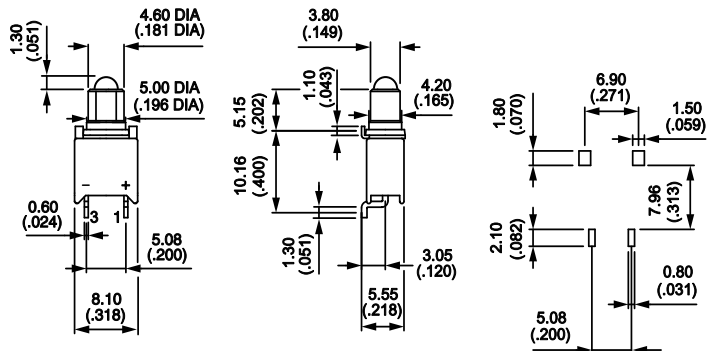

TP SERIES - SMT WASHABLE TINY PUSHBUTTON SWITCHES

REFLOW SOLDERING - STANDARD PROFILE

The printed circuit board, carried by a conveyor belt, travels through the reflow soldering oven and experiences the following programmed cycles:

- pre-heat to a maximum of 200°C for 30 seconds
- reflow at a maximum of 245°C for 10 seconds
- final cleaning

TEMPERATURE/TIME PROFILE (typical)

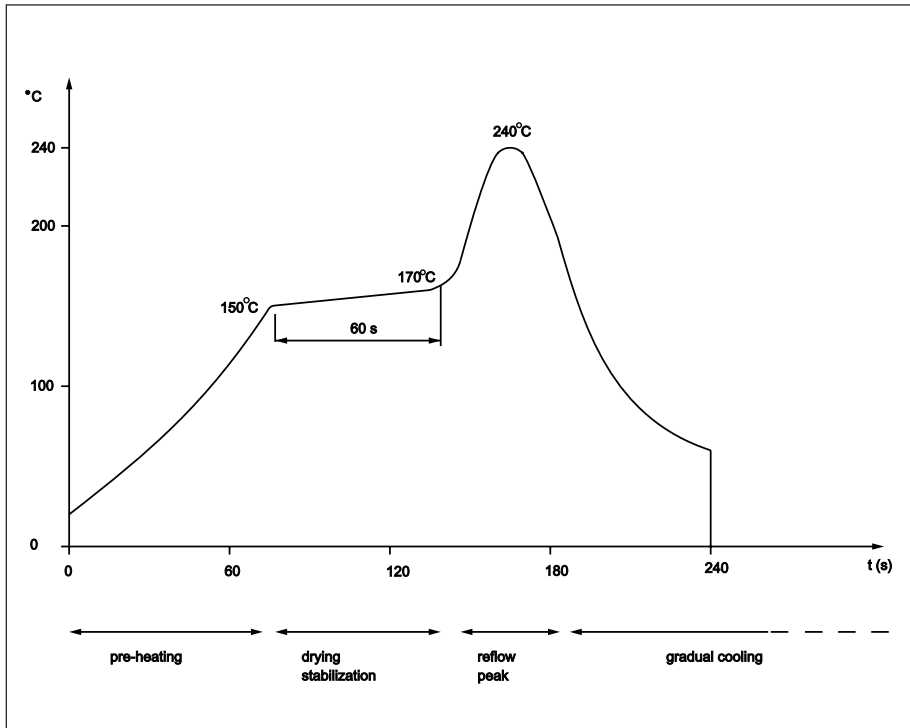

PROCESSING STEPS

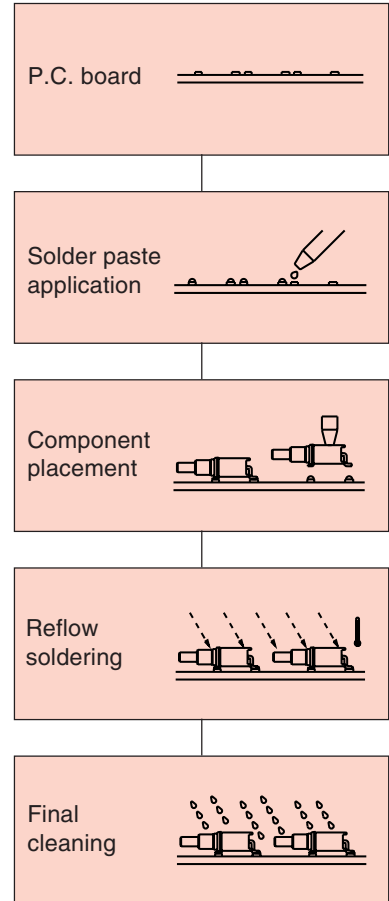

C

SPECIFICATIONS SUBJECT TO CHANGE WITHOUT NOTICE

P.C. BOARD REWORK RECOMMENDATIONS

Hot air reflow technique is preferred. Avoid the use of a soldering iron.

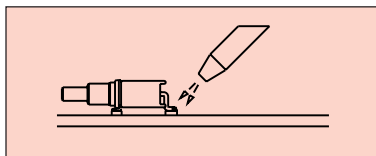

Caution: Excessive and/or repeated high temperature exposure may affect switch performance & reliability.

New! ZP SERIES - TINY PUSHBUTTON SWITCHES, PANEL & P.C. MTG.



C

FEATURES

- Wave solderable.
- Metal bushing, threaded with flat, or plain.
- Ultra-compact case size.
- SP momentary models with epoxy sealed terminals.

SPECIFICATIONS

Contact ratings (resistive loads):	Gold plated brass; 0.4 Volt-Amps max. at 20 V max. Silver plated brass; 0.5 Amps at 48 V max.
Minimum load:	10 mA at 50 mV - 10 μ A at 5 VDC
Initial contact resistance:	50 milliohms maximum
Insulation resistance:	1000 megohms minimum at 500 VDC
Dielectric strength:	1000 V rms minimum between terminals and frame. 500 V rms between terminals..
Electrical life:	Gold contacts: 2 positions, 60,000 cycles min. 3 positions, 30,000 cycles min. Silver contacts: 2 positions, 20,000 cycles min. 3 positions, 10,000 cyclesmin.
Operating temperature range:	-30°C to +85°C
Moisture resistance:	21 days 95% (NFC 20-603 - IEC 8-2-3)
Travel:	ON-MOM: 1.2mm \pm 0.3 (.047" \pm .011) OFF-MOM: 1mm \pm 0.3 (.039" \pm .011)
Terminal strength:	Pull out force 10N (2.24 lbs.)
Torque:	1Nm (0.96 ft-lbs) max. applied between 2 nuts
Panel thickness (max.):	1.5mm (.059") with 2 nuts - 3mm (.118") with 1 nut
Hardware:	Threaded models supplied with 2 hex nuts 7mm (.275") across flats, 1 locking ring and 1 lockwasher. See hardware section of catalog.

MATERIALS

Contacts & Terminals:	Gold or silver plated brass
Actuator:	Glass filled polyamide UL94-VO
Bushing:	Tin plated zamac
Bracket:	Tin plated steel
Case:	UL94-VO thermoplastic
Terminal seal:	Epoxy

ABOUT THIS SERIES

The material in this series is organized in the following sequence:



- a. Completely specified switch models
- b. 'build your own switch' order format
- c. Option drawings

SPECIFICATIONS SUBJECT TO CHANGE WITHOUT NOTICE

New! ZP SERIES - TINY PUSHBUTTON SWITCHES, PANEL & P.C. MTG.

Solder lug terminals - silver contacts - threaded bushing



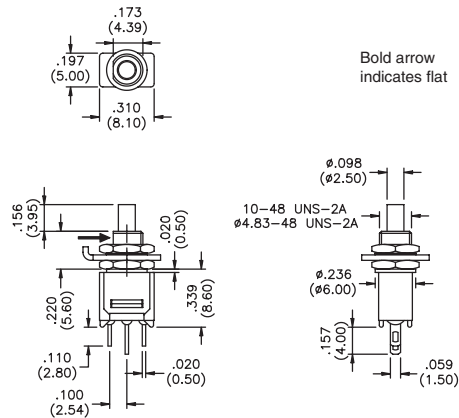

MODEL NO.		
ZP32S0101	ON	MOM
ZP33S0101	OFF	MOM



Bold arrow indicates flat

Straight p.c. terminals - gold contacts - threaded bushing



MODEL NO.		
ZP32P0001	ON	MOM
ZP33P0001	OFF	MOM

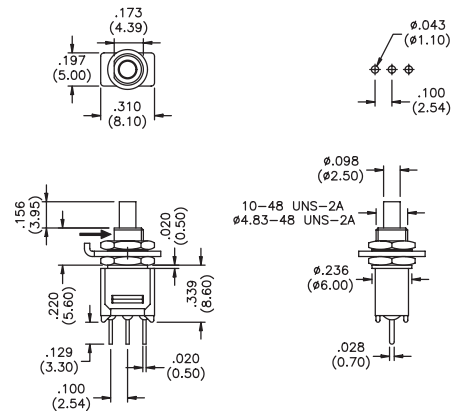

15.20mm (.598") wire-wrap terminals also available - to specify substitute **MW** for **P0** in above model numbers.



Bold arrow indicates flat

Straight p.c. terminals - mtg. bracket - gold contacts - plain bushing



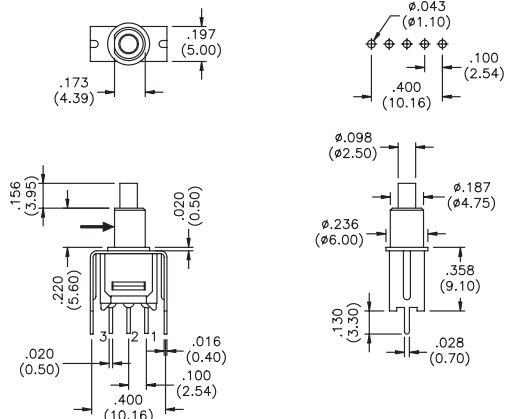

MODEL NO.		
ZP32Y0000	ON	MOM
ZP33Y0000	OFF	MOM



Bold arrow indicates flat

Horizontal right angle terminals - gold contacts - plain bushing



MODEL NO.		
ZP32W0000	ON	MOM
ZP33W0000	OFF	MOM

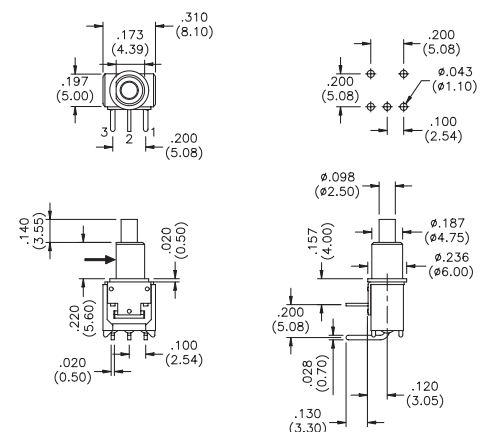

Bold arrow indicates flat



SPECIFICATIONS SUBJECT TO CHANGE WITHOUT NOTICE

C

New! ZP SERIES - TINY PUSHBUTTON SWITCHES, PANEL & P.C. MTG.

Vertical right angle terminals - gold contacts - plain bushing



MODEL NO.		
ZP32WW000	ON	MOM
ZP33WW000	OFF	MOM

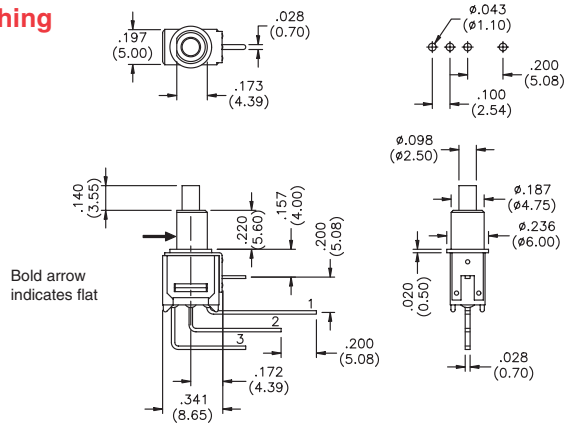

Additional ordering information: Commonly ordered models are shown above with complete model numbers and specifications. Below is an order format that enables you to 'build your own switch' and specify the correct switch model number by simply selecting from all available options shown and filling in the boxes.

'BUILD YOUR OWN SWITCH' ORDER FORMAT

Fill in boxes with selections shown for complete model number.
(Allowable options are shown below each respective box).

Series	Single pole	Electrical functions	Terminals	Contact & terminal mat'ls.	Bushings																												
Z P	3	<table border="1"> <tr><td>2</td><td>ON</td><td>MOM</td></tr> <tr><td>3</td><td>OFF</td><td>MOM</td></tr> </table>	2	ON	MOM	3	OFF	MOM	<table border="1"> <tr><td>S 0</td><td>Solder lug</td></tr> <tr><td>P 0</td><td>Straight p.c.</td></tr> <tr><td>Y 0</td><td>Straight p.c. with bracket</td></tr> <tr><td>W 0</td><td>Horizontal right angle</td></tr> <tr><td>W W</td><td>Vertical right angle</td></tr> <tr><td>M W</td><td>Wire-wrap</td></tr> </table>	S 0	Solder lug	P 0	Straight p.c.	Y 0	Straight p.c. with bracket	W 0	Horizontal right angle	W W	Vertical right angle	M W	Wire-wrap	<table border="1"> <tr><td>0</td><td>Brass, gold plated</td></tr> <tr><td>1</td><td>Brass, silver plated</td></tr> <tr><td>3</td><td>Brass, gold plated - (1.27 microns gold)</td></tr> </table>	0	Brass, gold plated	1	Brass, silver plated	3	Brass, gold plated - (1.27 microns gold)	<table border="1"> <tr><td>0 0</td><td>Plain</td></tr> <tr><td>0 1</td><td>Threaded with flat</td></tr> </table>	0 0	Plain	0 1	Threaded with flat
2	ON	MOM																															
3	OFF	MOM																															
S 0	Solder lug																																
P 0	Straight p.c.																																
Y 0	Straight p.c. with bracket																																
W 0	Horizontal right angle																																
W W	Vertical right angle																																
M W	Wire-wrap																																
0	Brass, gold plated																																
1	Brass, silver plated																																
3	Brass, gold plated - (1.27 microns gold)																																
0 0	Plain																																
0 1	Threaded with flat																																

Example of completely specified model number: **ZP32S0001**

Although most combinations of options are available, some may result in incompatibilities. Consult factory if there is any question.

BUSHINGS

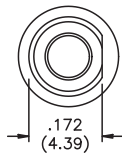

00 Plain, with flat (for models **YO**, **WO** and **WW**)

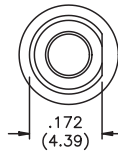

01 Threaded, with flat (for models **P0** and **S0**)

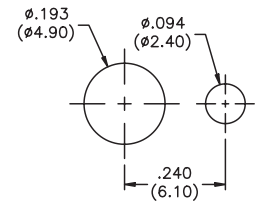
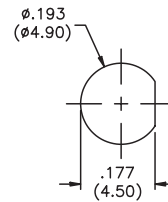

TERMINALS

CROSS SECTIONS

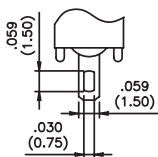

Solder lug

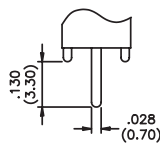

Printed circuit

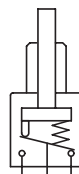

Function 2

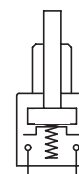

Function 3

TP SERIES - WASHABLE TINY MOMENTARY PUSHBUTTON SWITCHES



FEATURES

- Wave solderable.
- Fully sealed for process compatibility.
- Ultra-compact case size.
- Case color options - blue or black (with black actuator).
- SPST, SPDT, DPST & DPDT p.c. mounting models.

SPECIFICATIONS

Contact ratings (resistive loads):	Gold plated brass: 0.4 Volt-Amps max. at 20 V max. Silver plated brass: 0.5 Amps at 48 V max.
Minimum load:	10 mA at 50 mV - 10µA at 5 VDC
Initial contact resistance:	50 milliohms maximum
Insulation resistance:	1000 megohms minimum at 500 VDC
Dielectric strength:	1000 V rms min. between terminals and frame. 500 V rms between terminals.
Electrical life:	Gold contacts: 60,000 cycles min. at full load. Silver contacts: 20,000 cycles
Operating temperature range:	-30°C to +85°C
Plunger travel:	'ON MOM' - .039" (1mm) 'OFF MOM' - .031" (0.8mm)
Washing:	Permissible with water, detergents and solvents.

MATERIALS

Contacts & Terminals:	Gold or silver plated brass
Actuator:	Polyamide (UL94V-O), glass filled
Bracket:	Tin plated steel
Case:	PBT (UL94V-O)
Terminal seal:	Epoxy

AGENCY LISTINGS

GAM T1 (military). Availability: consult factory for details of listed models.

Note: drawings show switches with 3 terminals (function 2). Function 3 switches have only 2 terminals. See switch cross-sections at end of section.

Straight p.c. terminals - gold plated brass contacts



SINGLE POLE	
MODEL NO.	CIRCUIT
TP32P003000	ON MOM
TP33P003000	OFF MOM
DOUBLE POLE	
MODEL NO.	CIRCUIT
TP42P003000	ON MOM
TP43P003000	OFF MOM
Handle position:	

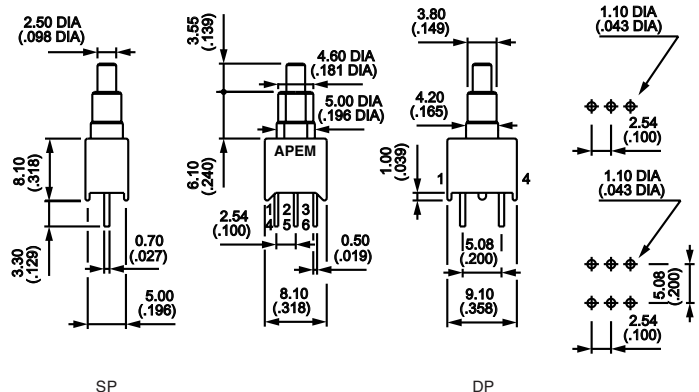

TP SERIES - WASHABLE TINY MOMENTARY PUSHBUTTON SWITCHES

Straight p.c. terminals - bracket mounting - gold plated brass contacts



SINGLE POLE		CIRCUIT	
MODEL NO.		ON	MOM
TP32Y003050		OFF	MOM
TP33Y003050			
DOUBLE POLE		CIRCUIT	
MODEL NO.		ON	MOM
TP42Y003050		OFF	MOM
TP43Y003050			
Handle position:			

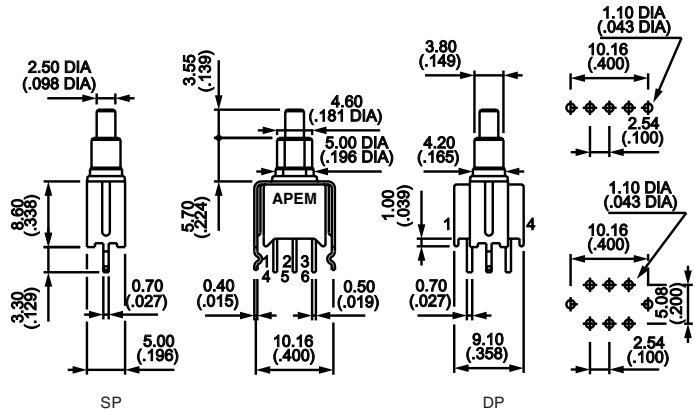

Horizontal right angle terminals - gold plated brass contacts



SINGLE POLE		CIRCUIT	
MODEL NO.		ON	MOM
TP32W003050		OFF	MOM
TP33W003050			
DOUBLE POLE		CIRCUIT	
MODEL NO.		ON	MOM
TP42W003050		OFF	MOM
TP43W003050			
Handle position:			

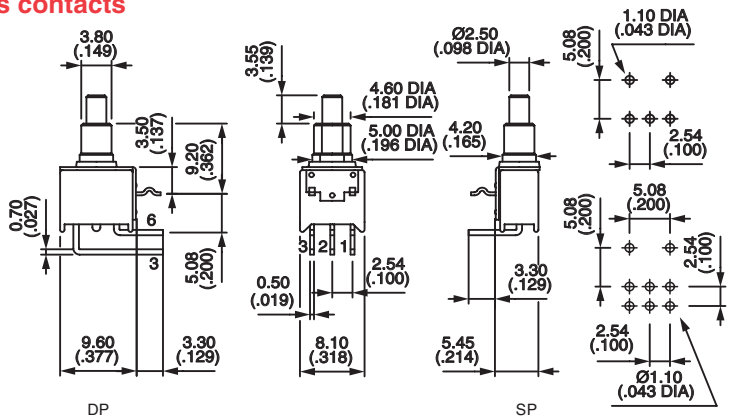

Vertical right angle terminals - gold plated brass contacts



SINGLE POLE		CIRCUIT	
MODEL NO.		ON	MOM
TP32WW03050		OFF	MOM
TP33WW03050			
DOUBLE POLE		CIRCUIT	
MODEL NO.		ON	MOM
TP42WW03050		OFF	MOM
TP43WW03050			
Handle position:			

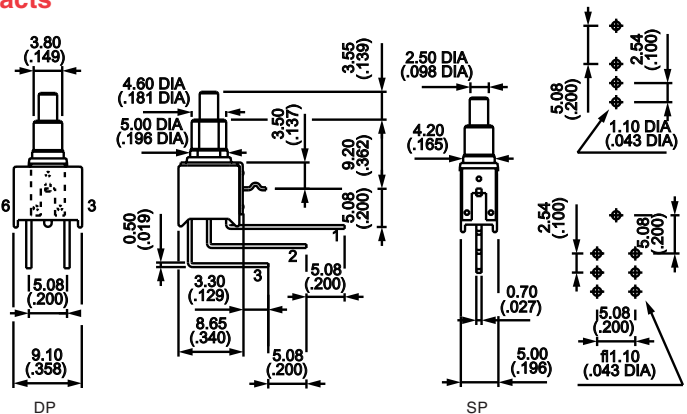

Wire-wrap terminals - gold plated brass contacts



SINGLE POLE		CIRCUIT	
MODEL NO.		ON	MOM
TP32MW03000		OFF	MOM
TP33MW03000			
DOUBLE POLE		CIRCUIT	
MODEL NO.		ON	MOM
TP42MW03000		OFF	MOM
TP43MW03000			
Handle position:			

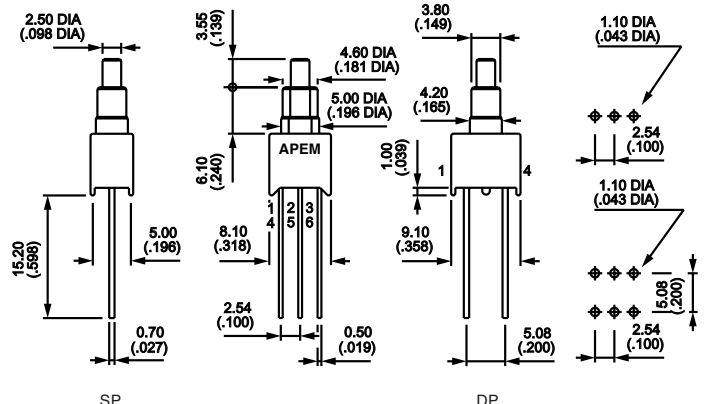

SPECIFICATIONS SUBJECT TO CHANGE WITHOUT NOTICE

TP SERIES - WASHABLE TINY MOMENTARY PUSHBUTTON SWITCHES

Additional ordering information: Commonly ordered models are shown above with complete model numbers and specifications. Below is an order format that enables you to 'build your own switch' and specify the correct switch model number by simply selecting from all available options shown and filling in the boxes.

'BUILD YOUR OWN SWITCH' ORDER FORMAT

Fill in boxes with selections shown for **Model Structure**, then add **Options** selections for complete model number. (Allowable options are shown under each respective box).

Model Structure:

Series	Number of poles	Electrical functions	Terminals
<input type="checkbox"/> T <input type="checkbox"/> P	<input type="checkbox"/>	<input type="checkbox"/>	<input type="checkbox"/>
	3 Single pole	2 ON MOM	P 0 Straight p.c.
	4 Double pole	3 OFF MOM	Y 0 Straight p.c.with bracket
			W 0 Horizontal right angle
			W W Vertical right angle
			M W Wire-wrap

Options:

Contact & terminal mat'ls.	Actuators & case colors	Miscellaneous	Caps (for long actuator only)
<input type="checkbox"/>	<input type="checkbox"/>	<input type="checkbox"/>	<input type="checkbox"/>
0 Brass, gold plated	Specify 30, 35, 80, 82, or 85	0 0 No special requirement	3 0*
1 Brass, silver plated	See drawings with specifications and dimensions.	5 0 Crimped bracket terminals - specify for models with brackets. See additional listings on following page.	4 0*
3 Brass, gold plated - (1.27 microns gold)			* - Specify color - see caps below.
8 Brass, gold plated contacts with tin plated terminals			
9 Contacts brass, gold plated (1.27 microns gold) and tin plated terminals			

Example of completely specified model number: **TP32Y00305025**

OPTION DRAWINGS

Actuators & case colors

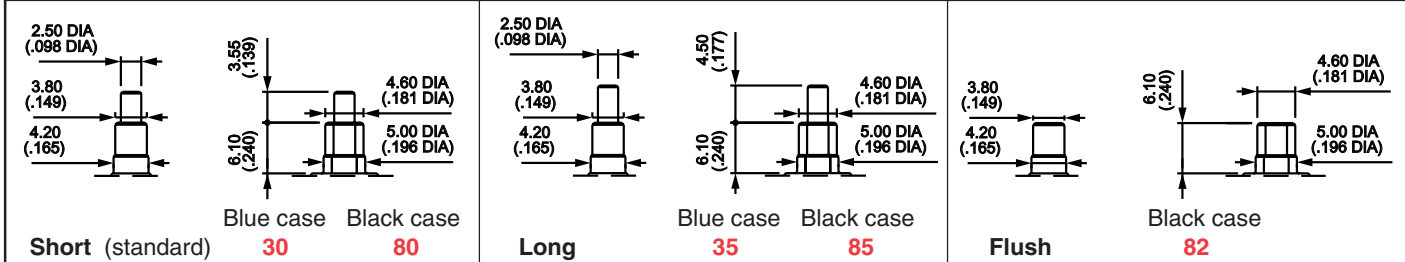

CAPS Note: replace last '0' in part numbers with color code.

For long actuator only

For long actuator only

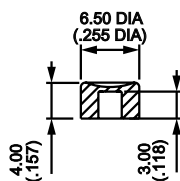

30
U4310 If ordered separately

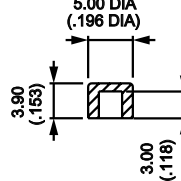

40
U4320 If ordered separately

Colors	
1	blue
2	black
3	green
4	grey
5	yellow
6	red
7/1	white
9	orange

SPECIFICATIONS SUBJECT TO CHANGE WITHOUT NOTICE

C

TP SERIES - WASHABLE TINY MOMENTARY PUSHBUTTON SWITCHES

SPECIAL OPTIONS & MISCELLANEOUS

SPECIAL OPTIONS

- 00** No special requirement.
- 07** Trimmed terminals for **WW** models only - .125" (3.2mm).
- 08** Extended terminals for **W0** models only.
- 18** **WW** models without mounting bracket.
- 20** **WW** models with mounting bracket and p.c. board spacer tab.
- 25** Trimmed terminals for all models except **WW** - .196" (5mm).
- 30** Wire-wrap terminals on models with **Y** bracket.
- 40** With cap **U3500** mounted over plunger and bushing.
Provides additional protection during soldering & cleaning.
- 50** Crimped bracket terminals (retains switch on p.c. board during assembly and soldering). For models with **W0**, **WW** & **Y0** terminals.

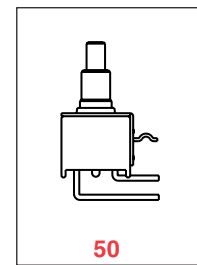
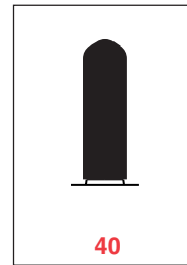
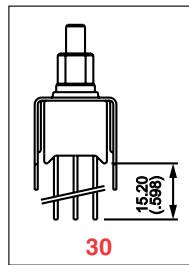
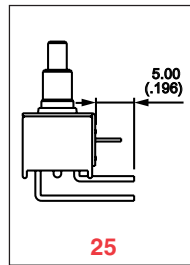
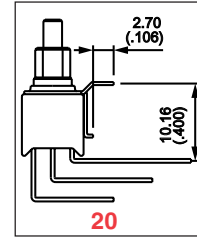
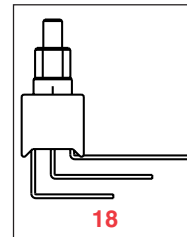
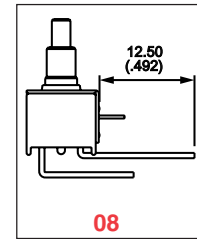
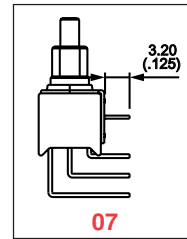

Switch cross-sections

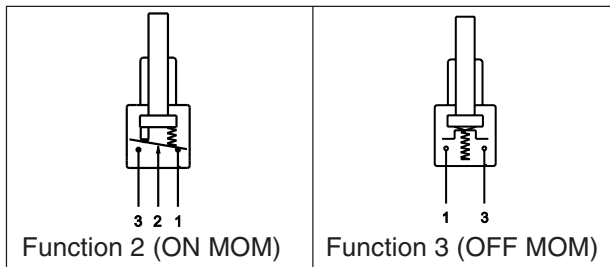

SPECIFICATIONS SUBJECT TO CHANGE WITHOUT NOTICE

9000 SERIES - SUBMINIATURE MOMENTARY PUSHBUTTON SWITCHES

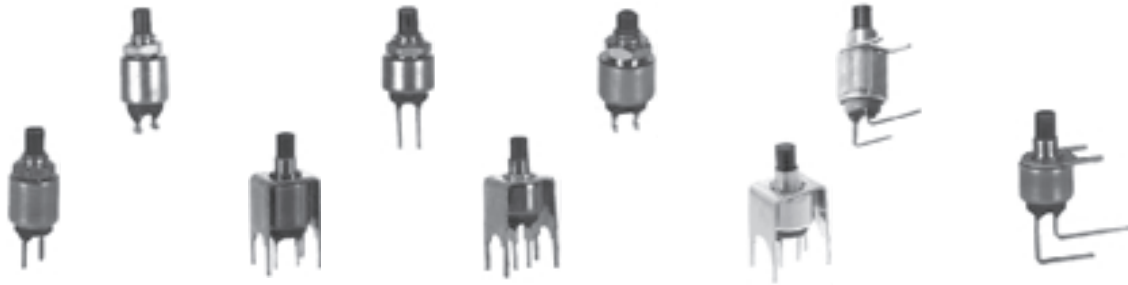

FEATURES

- Single pole panel and p.c. mounting models.
- Normally open (NO) & normally closed (NC) electrical functions.
- Self-cleaning or butt action contacts.
- Ultra-compact case size.

SPECIFICATIONS

Contact ratings (resistive loads):	100 mA at 30 VDC
Initial contact resistance:	30 milliohms maximum
Insulation resistance:	1000 megohms minimum at 500 VDC
Dielectric strength:	500 V rms min. between terminals. 1000 V rms between terminals & case
Electrical life:	9100, 9200N & 9500N: 250,000 cycles min. 9200 & 9500: 100,000 cycles min.
Operating temperature range:	-30°C to +65°C
Panel thickness:	1.50mm (.059") max.

Travel	9533 & 9233	9532 & 9232	9533N, 9233N & 9133
Total	.062" (1.60mm)	.070" (1.80mm)	.035" (0.9mm)
Pre-	.029" (0.75mm)	.039" (1.00mm)	-
Over-	.027" (0.70mm)	.029" (0.75mm)	-

MATERIALS

Contacts & Terminals:	Gold plated brass
Actuator:	Polyamide, glass filled
Bracket:	Tin plated steel
Case:	PPS
Bushing:	Nickel plated brass
Terminal seal:	Epoxy
Hardware:	Threaded bushing models supplied with 1 Hex Nut p/n U544. See drawing - end of section.

Solder lug terminals - threaded bushing - self-cleaning contacts

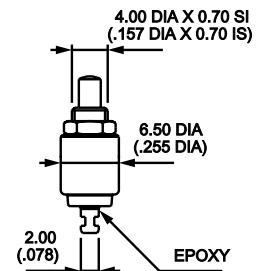
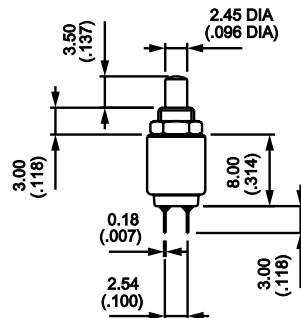
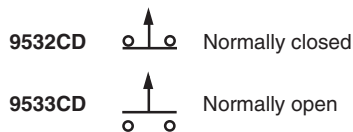

9000 SERIES - SUBMINIATURE MOMENTARY PUSHBUTTON SWITCHES

Straight p.c. terminals - threaded bushing - self-cleaning contacts

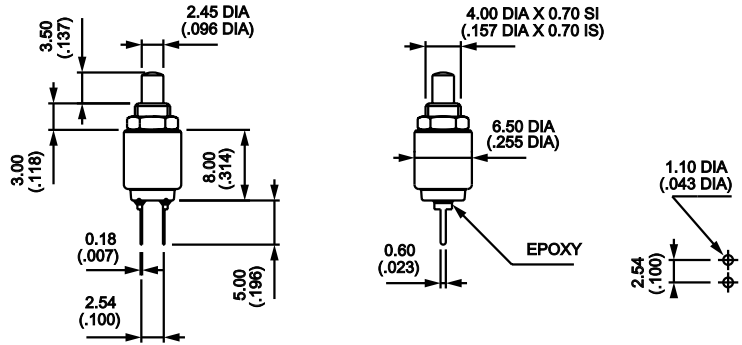
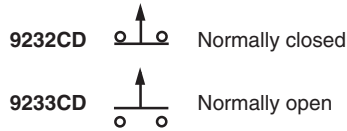

Straight p.c. terminals - bracket mounting - self-cleaning contacts

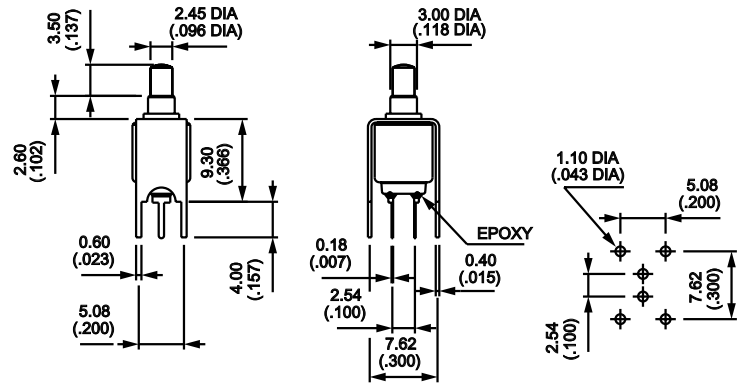
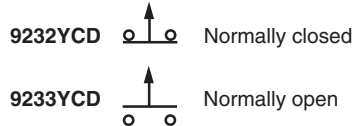

Right angle p.c. terminals - self-cleaning contacts

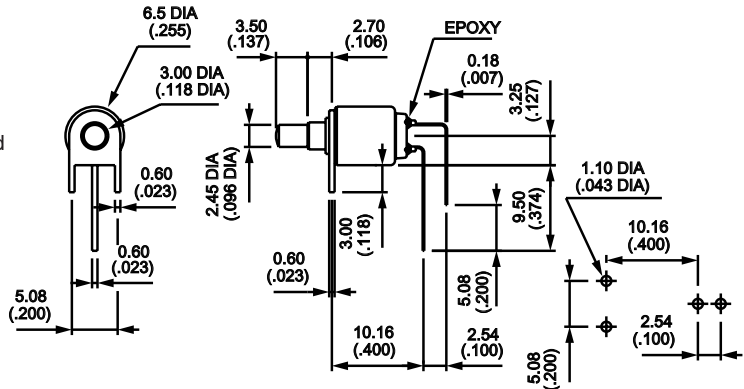
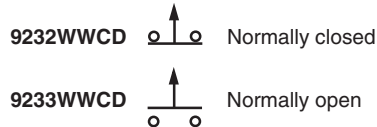

Solder lug terminals - threaded bushing - butt action contacts

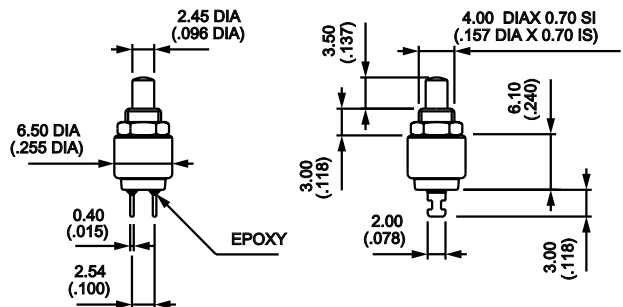
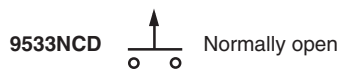

SPECIFICATIONS SUBJECT TO CHANGE WITHOUT NOTICE

9000 SERIES - SUBMINIATURE MOMENTARY PUSHBUTTON SWITCHES

Straight p.c. terminals - threaded bushing - .350" (8.9mm) p.c. to panel - butt action contacts

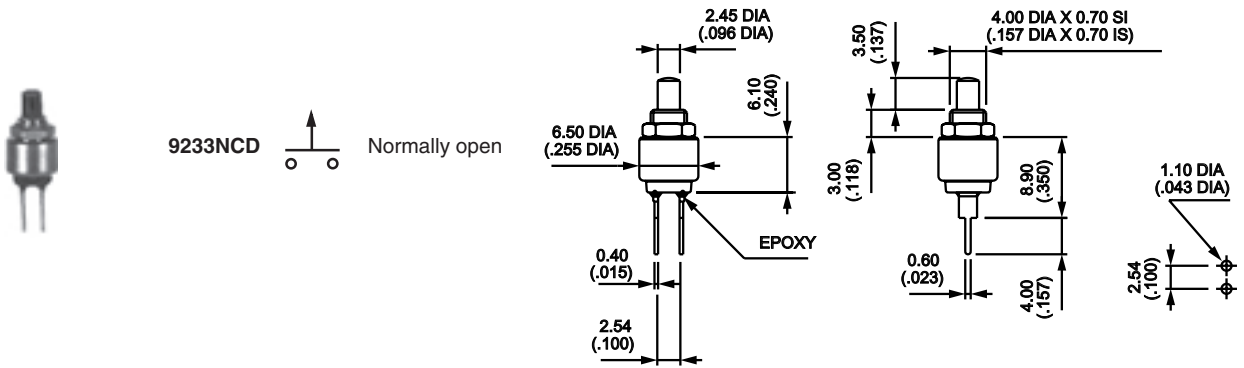

Straight p.c. terminals - threaded bushing - .279" (7.1mm) p.c. to panel - butt action contacts

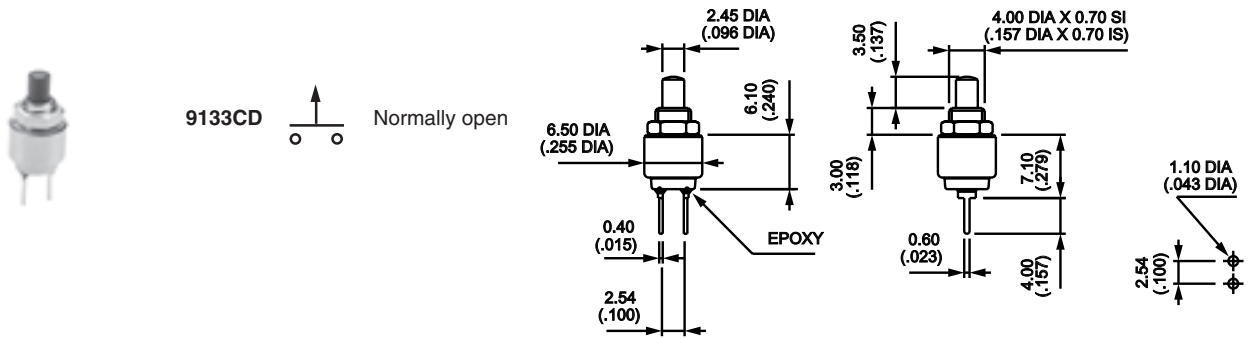

Straight p.c. terminals - tall bracket mounting - butt action contacts

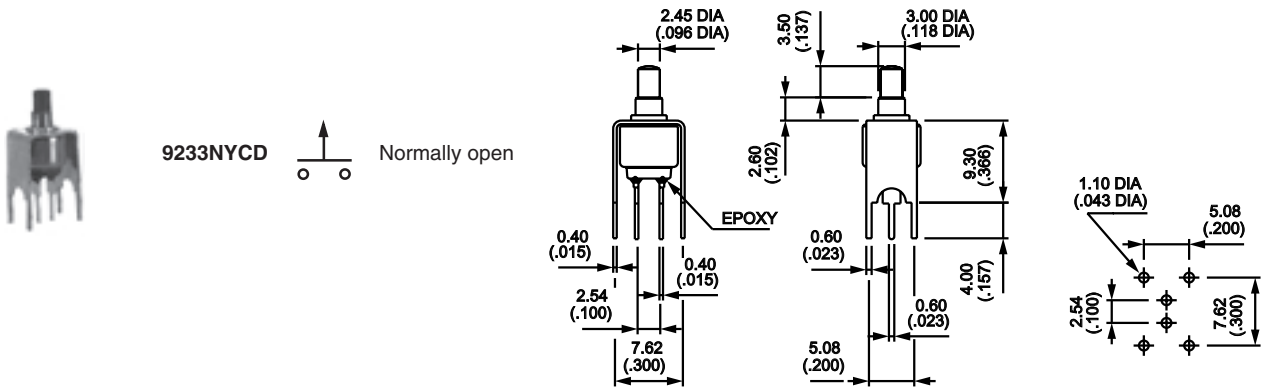

Straight p.c. terminals - short bracket mounting - butt action contacts

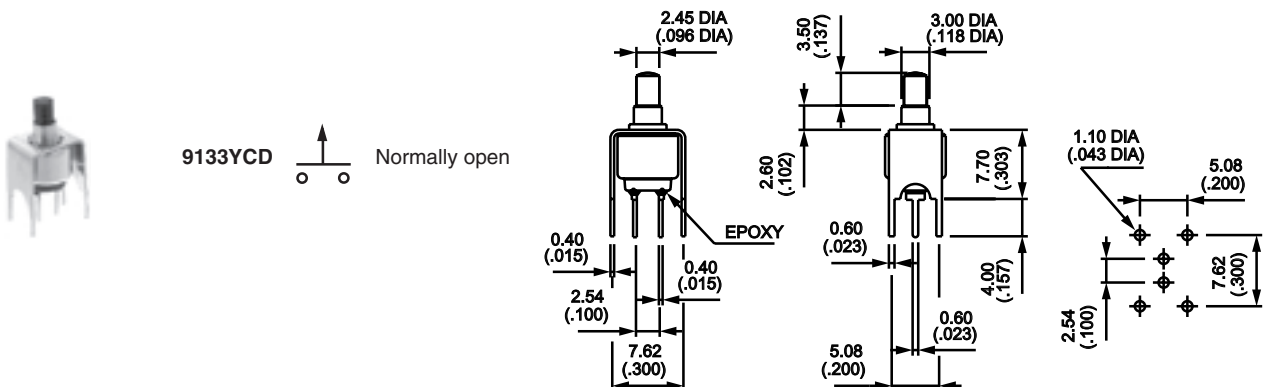

SPECIFICATIONS SUBJECT TO CHANGE WITHOUT NOTICE

C

9000 SERIES - SUBMINIATURE MOMENTARY PUSHBUTTON SWITCHES

Right angle p.c. terminals - butt action contacts



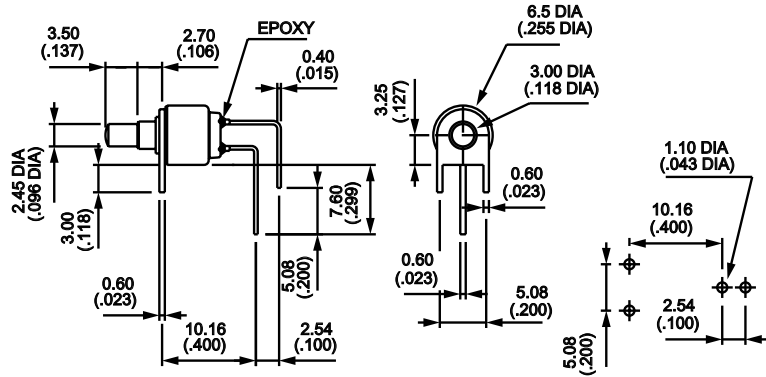

9133WWCD 
Normally open



New! Models with press-in mounting bezel



Normally closed
9232CD4+U4316+U4922 
Normally open
9233CD4+U4316+U4922 

The highly cosmetic black bezel enables mounting on a front panel by merely pressing into a .320" dia. (8.15mm) panel hole. Arrays can be closely mounted, left to right or up and down. Red contoured actuator cap (U4316) indicated. See Cap options on next pg. for other available colors

Additional ordering information: Commonly ordered models are shown above with complete model numbers and specifications. Below is an order format that enables you to 'build your own switch' and specify the correct switch model number by simply selecting from all available options shown and filling in the boxes.

'BUILD YOUR OWN SWITCH' ORDER FORMAT

Fill in boxes with selections shown for **Model Structure**, then add **Options** selections for complete model number. (Allowable options are shown under each respective box). Note: 'NONE' indicates box may be left empty.

Model Structure: **Series** **Terminals case height** **Number of poles** **Electrical function** **Bracket/ terminals**



Single pole 2 Normally closed (NC)
3 Normally open (NO)

Case height .314" (8mm)

- 2.....Straight p.c. terminals, threaded bushing.....(NONE)
- 2.....Straight p.c. terminals, tall bracket, smooth bushing.....Y
- 2.....Right angle p.c. terminals, bracket, smooth bushing..... W W
- 5.....Solder lug terminals, threaded bushing..... (NONE)

Case height .240" (6.1mm)

- 1.....Straight p.c. terminals, threaded bushing .279" (7.1mm) to panel.....(NONE)
- 1.....Straight p.c. terminals, short bracket, smooth bushing.....Y
- 1.....Right angle p.c. terminals, bracket, smooth bushing..... W W
- 2.....Straight p.c. terminals, threaded bushing, .350" (8.9mm) to panel.....N
- 2.....Straight p.c. terminals, tall bracket, smooth bushing..... N Y
- 5.....Solder lug terminals, threaded bushing..... N

Although most combinations of options are available, some may result in incompatibilities. Consult factory if there is any question.

Caps available separately - see option drawings.

Options:

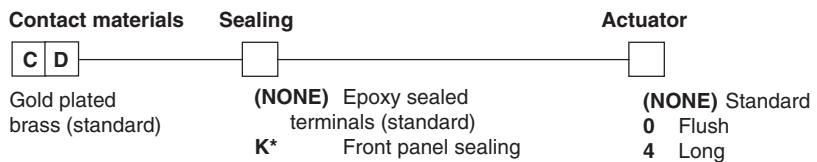

Example of completely specified model number: **9233YCD**

* for models 9533N, 9233N & 9133 only.

SPECIFICATIONS SUBJECT TO CHANGE WITHOUT NOTICE

9000 SERIES - SUBMINIATURE MOMENTARY PUSHBUTTON SWITCHES

MISCELLANEOUS

SWITCH ACTION

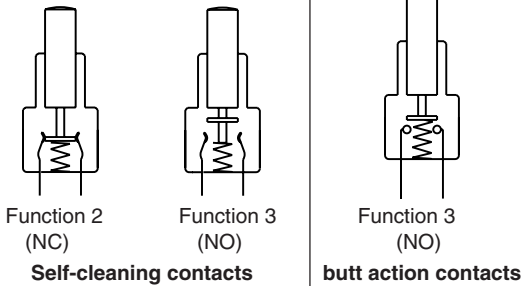

TERMINAL OUTLINES

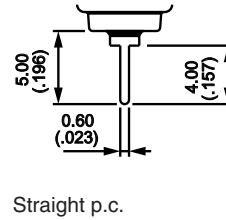
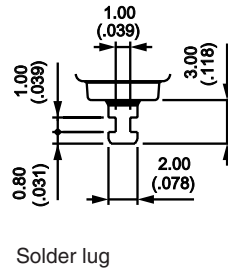

PANEL CUT-OUT

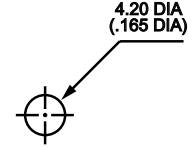

OPTION & HARDWARE DRAWINGS

ACTUATOR OPTIONS

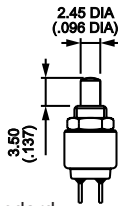

(NONE) Standard



0 Flush



4 Long

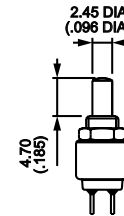

CAPS Note: replace last '0' in p/n with color code. (order separately)

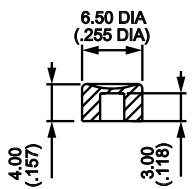

U4310
For 4 actuator only

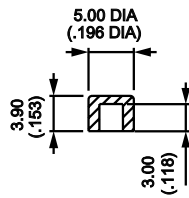

U4320
For 4 actuator only

Colors

- 1 blue
- 2 black
- 3 green
- 4 grey
- 5 yellow
- 6 red
- 7/1 white
- 9 orange

SEALING OPTION

K Front panel sealing with 2 'O'-rings (1) provides protection against water and dust. Panel seal withstands 0.1bar pressure

(K option for models 9533N, 9233N and 9133 only).

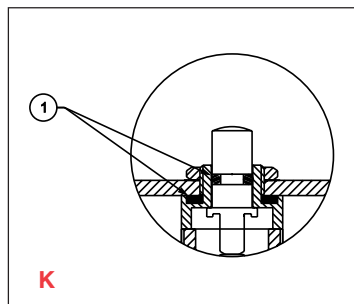

HEX NUT Supplied with threaded bushing models

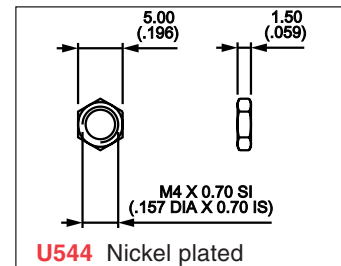

SPECIFICATIONS SUBJECT TO CHANGE WITHOUT NOTICE

C

9000 SERIES - MINIATURE MOMENTARY PUSHBUTTON SWITCHES

C



FEATURES

- Single pole panel mounting models.
- NO, NC & NC/NO combined electrical functions.
- Solder lug & straight p.c. terminals.
- Compact case size.
- Supplied with 2 Hex Nuts & Lockwasher.

SPECIFICATIONS

Contact ratings (resistive loads):	Gold plated brass: 100 mA at 30 VDC Silver: 0.3 Amps at 250 VAC, 0.6 Amps at 125 VAC or 1 Amp at 30 VDC
Initial contact resistance:	50 milliohms maximum
Insulation resistance:	1000 megohms minimum at 500 VDC
Dielectric strength:	1000 V rms min. between terminals. 1500 V rms between terminals & case
Electrical life:	250,000 cycles minimum
Operating temperature range:	-30°C to +65°C
Travel:	9600, 9400 & 9400Y models - .051" (1.3mm) 9600N & 9400N models - .035" (0.9mm)

MATERIALS

Contacts & Terminals:	Gold plated brass or silver
Actuator:	Polyamide, glass filled or nickel plated brass (with K option)
Bracket:	Tin plated steel
Case:	Diallyl phthalate
Bushing:	Nickel plated brass
Terminal seal:	Epoxy
Hardware:	Supplied with 2 Hex Nuts .314" (8mm) across flats & 1 Lockwasher See hardware section of catalog.

Solder lug terminals - case length .440" (11.2mm) - silver contacts

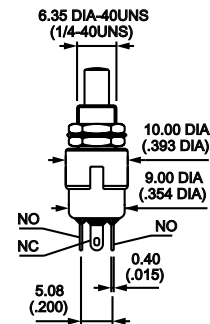
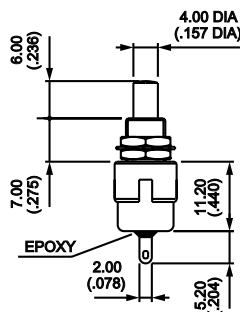
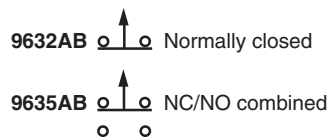

SPECIFICATIONS SUBJECT TO CHANGE WITHOUT NOTICE

9000 SERIES - MINIATURE MOMENTARY PUSHBUTTON SWITCHES

Straight p.c. terminals - case length .440" (11.2mm) - gold plated brass contacts

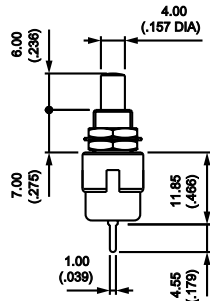
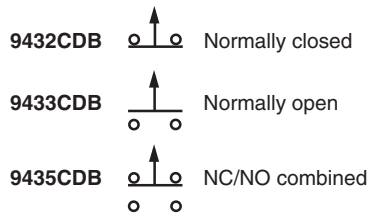

F2

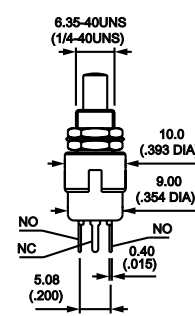

F5

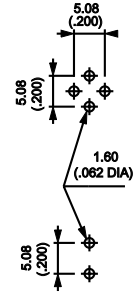

Bracket mounting w/straight p.c. terminals - case length .440" (11.2mm) - gold plated brass contacts

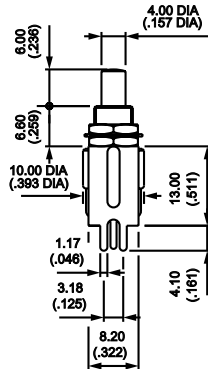
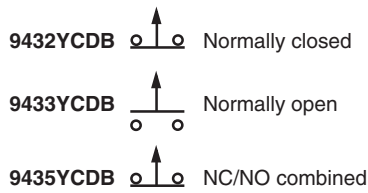

F2

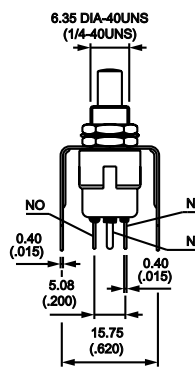

F5

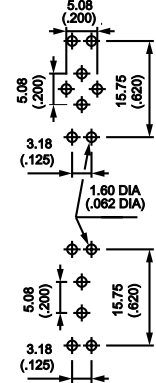

Solder lug terminals - case length .334" (8.5mm) - silver contacts

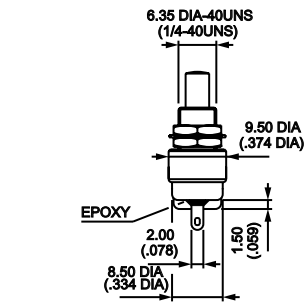
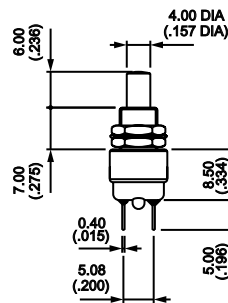
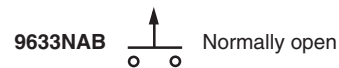

Straight p.c. terminals - case length .334" (8.5mm) - gold plated brass contacts

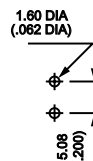
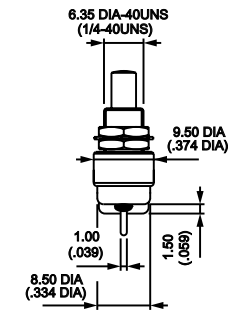
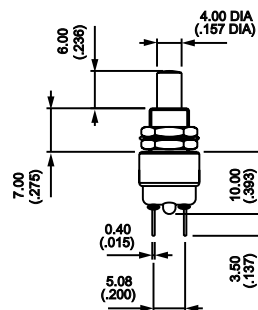
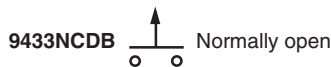

SPECIFICATIONS SUBJECT TO CHANGE WITHOUT NOTICE

C

9000 SERIES - MINIATURE MOMENTARY PUSHBUTTON SWITCHES

Solder lug terminals - .630" dia. (16mm) bushing - metal button - silver contacts



Silver contacts
9633AX1146  Normally open

Gold plated silver contacts
9633ADX1146  Normally open

Panel cut-out: .637" dia. (16.2mm)
 Maximum rating: 0.3A 250VAC or 1A 30VDC
 Epoxy sealed terminals.
 Other options not applicable for this configuration

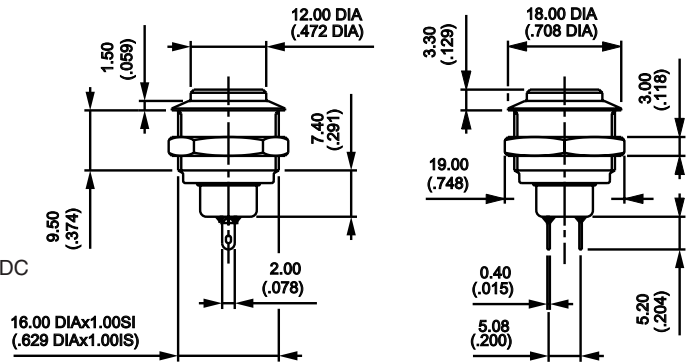

Additional ordering information: Commonly ordered models are shown above with complete model numbers and specifications. Below is an order format that enables you to 'build your own switch' and specify the correct switch model number by simply selecting from all available options shown and filling in the boxes.

'BUILD YOUR OWN SWITCH' ORDER FORMAT

Fill in boxes with selections shown for **Model Structure**, then add **Options** selections for complete model number. (Allowable options are shown under each respective box).

Note: 'NONE' indicates box may be left empty.

Model Structure:

Series	Terminals/case length	Number of poles	Electrical function	Bracket/case length
9	<input type="checkbox"/>	3	<input type="checkbox"/>	<input type="checkbox"/>
	4 Straight pc terms., case length .440" (11.2mm) 6 Solder lug terms., case length .440" (11.2mm) 4 Straight pc terms. with optional case length/brkt. - select N or Y from 'brkt/case length' box 6 Solder lug terms. with optional case length - indicate N in 'brkt/case length' box	Single pole	2 Normally closed (NC) 3 Normally open (NO) 5 NC/NO combined	(NONE) N Case length - .334" (8.5mm) Y Brkt. mounting, case length - .456" (11.6mm)

Options:

Contact materials	Sealing	Special options
<input type="checkbox"/> <input type="checkbox"/> A Silver C D Brass, gold plated	<input type="checkbox"/> (NONE) No sealing B Epoxy sealed terminals K Front panel sealing with two 'o-rings & metal actuator'	<input type="checkbox"/> <input type="checkbox"/> <input type="checkbox"/> <input type="checkbox"/> (NONE) F Tin plated terminals (for p.c. terms. only) X 6 0 1 Special contact w/ lower rating

Example of completely specified model number: **9432YCDBF**

Caps available separately - see option drawings.

Although most combinations of options are available, some may result in incompatibilities. Consult factory if there is any question.

MISCELLANEOUS

SWITCH ACTION

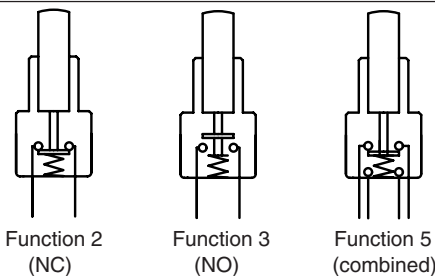

TERMINAL OUTLINES

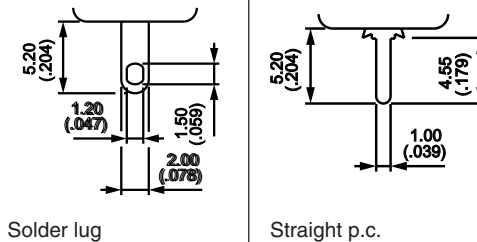

PANEL CUT-OUT

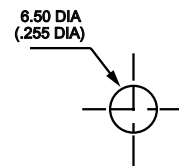

SPECIFICATIONS SUBJECT TO CHANGE WITHOUT NOTICE

9000 SERIES - MINIATURE MOMENTARY PUSHBUTTON SWITCHES

OPTION DRAWINGS & SPECIAL OPTIONS

CAPS Note: replace last '0' in p/n with color code. (order separately)

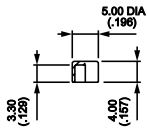

U900

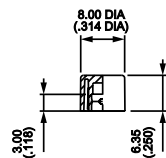

U1140

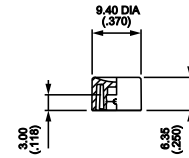

U1720

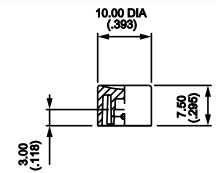

U480 Standard

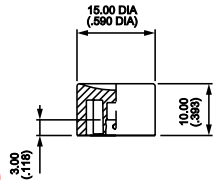

U630

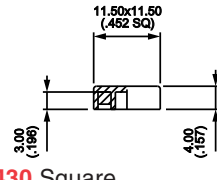

U2430 Square

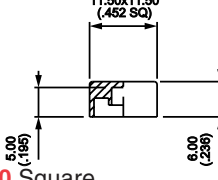

U2020 Square

Colors

- | | |
|-----|--------|
| 1 | blue |
| 2 | black |
| 3 | green |
| 4 | grey |
| 5 | yellow |
| 6 | red |
| 7/1 | white |
| 9 | orange |

DRESS NUTS Chrome plated. Order separately.

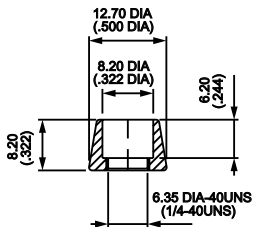

U1636 (for cap U1140)

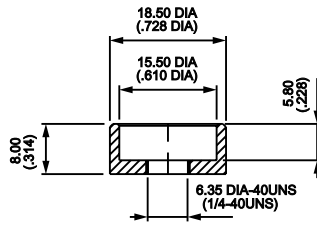

U825 (for cap U630)

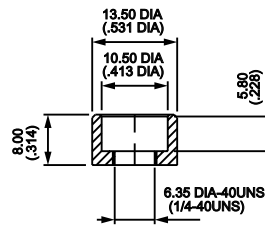

U840 (for cap U480)

SPECIAL OPTIONS

F Tin plated terminals (for p.c. terminals only).

X601 Silver plated brass contacts
 Contact ratings: 0.2A 250VAC, 0.4A 125VAC or 0.5A 30VDC
 Electric life: 20,000 cycles minimum.
 Minimum quantity: 5,000 pieces.

SPECIFICATIONS SUBJECT TO CHANGE WITHOUT NOTICE

C

10400 SERIES - PROFESSIONAL MINIATURE MOMENTARY PUSHBUTTON SWITCHES

C



FEATURES

- Single and double pole panel mounting models with optional matte black finish.
- ON - MOM electrical functions.
- Solder lug terminals.
- Compact case size with 10mm (.393") diameter threaded bushing.
- Epoxy terminal sealing standard.

SPECIFICATIONS

Contact ratings & life: (resistive loads)	Silver or gold plated silver: 3 Amps at 110 VAC, 2 Amps at 220 VAC or 3 Amps at 24 VDC.
Initial contact resistance:	10 m Ω max.
Insulation resistance:	1000 megohms min. at 500 VDC
Dielectric strength:	1000 V rms min. between terminals of the same pole 2000 V rms min. between terminals and frame 2000 V rms min. between terminals of adjacent poles
Electric life:	50,000 cycles min.
Torque:	1.106 Ft-lbs. (1.50 Nm) max. applied to nut
Operating temp. range:	-40°C to +85°C

MATERIALS

Contacts & Terminals:	Silver or gold plated silver
Actuator:	Chrome plated brass
Case:	Diallyl phthalate
Housing:	Nickel plated brass
Bushing:	Nickel plated brass
Terminal seal:	Epoxy

AGENCY LISTINGS

CECC 96401-001	Availability: Consult factory for details of approved models. Marking: To order switches marked CECC, add 'CECC' to model number.
----------------	--

SPECIFICATIONS SUBJECT TO CHANGE WITHOUT NOTICE

10400 SERIES - PROFESSIONAL MINIATURE MOMENTARY PUSHBUTTON SWITCHES

Single pole - solder lug terminals



	A	B
Silver contacts	1-2	1-3
104350003	ON -	MOM
Gold plated silver contacts		
104350108	ON -	MOM
Standard hardware supplied:		
	1 Knurled nut, 1 hex nut, 1 locking ring and 1 lockwasher	

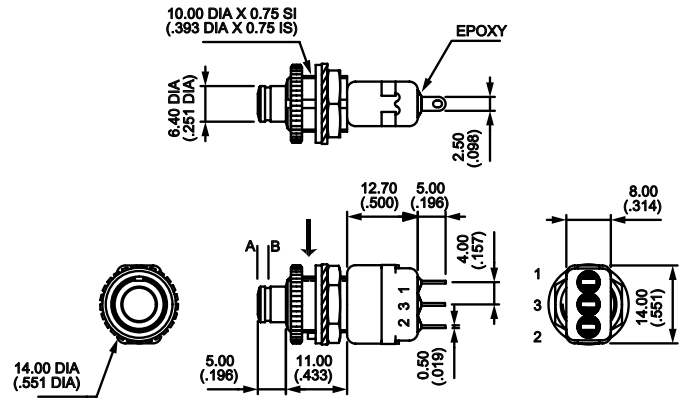

Double pole - solder lug terminals



	A	B
Silver contacts	2-1	2-3
	5-4	5-6
104450003	ON -	MOM
Gold plated silver contacts		
104450108	ON -	MOM
Standard hardware supplied:		
	1 Knurled nut, 1 hex nut, 1 locking ring and 1 lockwasher	

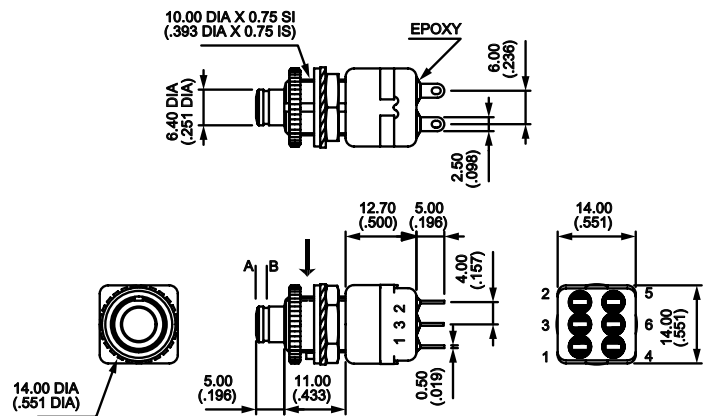

MISCELLANEOUS

SWITCH ACTION

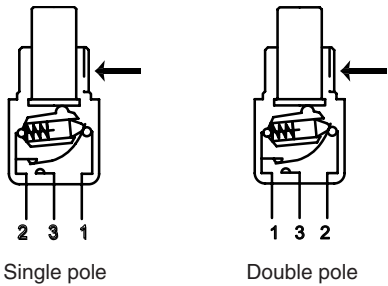

TERMINAL OUTLINE

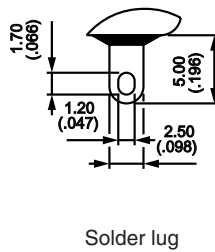

PANEL CUT-OUT

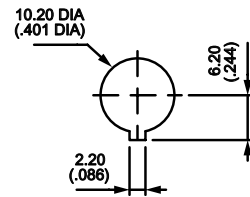

Note: Bold arrow in drawings indicates keyway.

SPECIFICATIONS SUBJECT TO CHANGE WITHOUT NOTICE

C

300 & 400 SERIES - MINIATURE PUSHBUTTON SWITCHES



FEATURES

- Dry circuit through power ratings .
- Compact size SPST momentary and alternate action models with numerous options.
- Panel, panel & p.c. and p.c. mounting models, lighted and unlighted.

SPECIFICATIONS

Contact ratings & life:

(Q) power models - coin silver: 1 Amp at 125 VAC or 28 VDC or 0.5 Amps at 250 VAC - electric life 250,000 cycles min. 3 Amps at 125 VAC or 28 VDC, or 1.5 Amps at 250 VAC - electric life 10,000 cycles min. (All previous loads are resistive).

(B) dry circuit models - gold over nickel over brass: 0.4 VA max. at 20 V max.- electric life 250,000 cycles min.

UL models - coin silver: 1 Amp at 125 VAC or 0.5 Amps at 250 VAC (75% power factor). UL file no. E66367.

Initial contact resistance:

10 milliohms max. at 3 VDC, 0.1 Amp.

Insulation resistance:

Greater than 10,000 megohms.

Dielectric strength:

1000 Volts RMS min. at sea level.

Operating temperature range:

-30°C to +85°C

MATERIALS

Contacts:

Coin silver for power & UL models. Gold over nickel over brass for dry circuit models.

Actuator:

Nylon. Black color is standard for 300 Series. White is standard for 400 Series.

Bushing:

Nickel plated brass

Base:

Melamine phenolic, color red.

Terminal seal:

Epoxy (standard)

Support bracket:

Brass or steel, tin plated

Spring mounting bracket:

Stainless steel

Bezel & cap:

Nylon. Available in black, red or white. Consult factory for other colors.

Hardware:

See Miscellaneous section.

LED:

Intensity: 2.0 mcd at 10 mA. Forward voltage: 2.0V (3.0V max.). Max. continuous forward current: 30 mA at 25°C. Red standard - yellow & green are optional. Specifications are subject to change without notice - consult factory.

AGENCY RECOGNITION



UL Marking: Switches ordered with 'UL' added at end of model no. are supplied with recognized mark.

ABOUT THIS SERIES

The material in this series is organized in the following sequence:

- Completely specified switch models & options
- 'build your own switch' order format
- Additional options & panel cut-outs

300 & 400 SERIES - MINIATURE PUSHBUTTON SWITCHES

300 SERIES SPST Momentary (Normally open or normally closed)

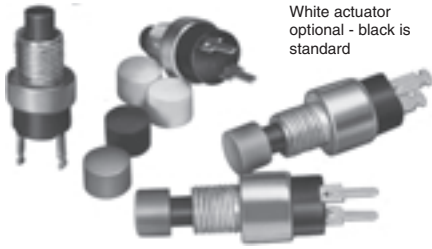

White actuator optional - black is standard

Switch caps optional - see Hardware section of catalog.

(Q) Power Model No.	(B) Dry ckt. Model No.	UL Model No.
301ZQE	301ZBE	301ZQE/UL
302ZQE	302ZBE	302ZQE/UL
303ZTE*	303ZBE	n/a
304ZTE*	304ZBE	n/a
305ZQE	305ZBE	305ZQE/UL
306ZQE	306ZBE	306ZQE/UL

* indicates 'Q' option not available for these models

301

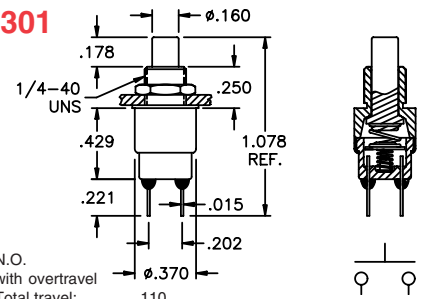

N.O. with overtravel
Total travel: .110
Overtravel: .020 min.
Actuation force: 8.5 oz. ± 4 oz.

302

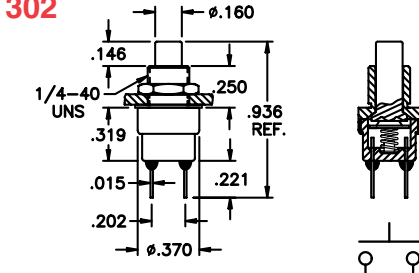

N.O. without overtravel
Total travel: .060
Actuation force: 10 oz. ± 4 oz.

303

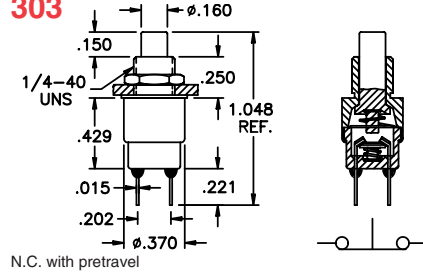

N.C. with pretravel
Total travel: .055
Pretravel: .020 min.
Actuation force: 8 oz. ± 4 oz.

304

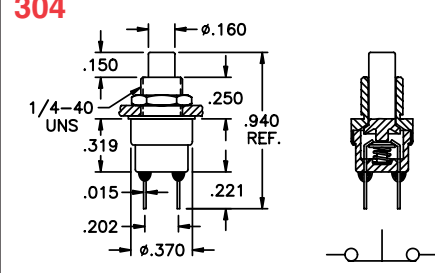

N.C. without pretravel
Total travel: .040
Actuation force: 8.5 oz. ± 4 oz.

305

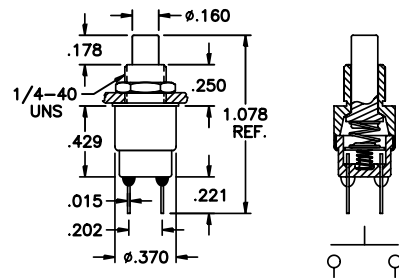

N.O. with more overtravel than 301
Total travel: .110
Pretravel to contact closure: .030
Actuation force to contact closure: 3 oz.
Overtravel: .075
Actuation force at full travel: 8 oz.

306

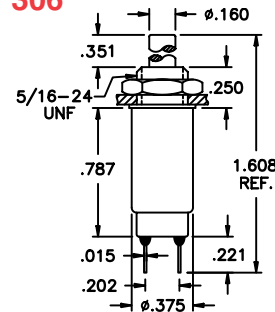

N.O. with sealed contact area and maximum overtravel.
Total travel: .310
Pretravel to contact closure: .025
Actuator force to contact closure: 1.5 oz.
Overtravel: .250 minimum
Actuation force at full travel: 9 oz.
Note: Electrical or mechanical life for this model is 20,000 cycles.

400 SERIES (401 Push on/ push off, 402 N.O. momentary)



Black actuator optional - white is standard

United States Patent 4,319,106

Switchcaps optional - see Hardware section of catalog.

(Q) Power Model No.	(B) Dry ckt. Model No.	UL Model No.
401ZQE	401ZBE	401ZQE/UL
402ZQE	402ZBE	402ZQE/UL

SNAP-ACTION MECHANISM

Pretravel to contact closure: .026
Travel to actuate switch: .106
Total travel: .137
Force to actuate switch: 22 oz.
Force at maximum travel: 35 oz.
Mechanical life: 1,000,000 cycles minimum

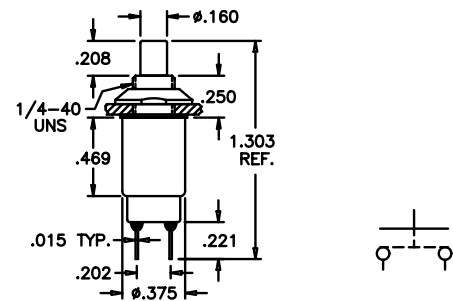

NOTE: When using sealing boot U5321 with 400 Series switches, add 'S1' to model number.

OPTIONS

Colored operating actuator

Available in dyed nylon. To specify, add digit at end of model number - 1 blue, 2 black, 3 green, 5 yellow, 6 red, 7/1 white or 9 orange. Black is standard for 300 Series. White is standard for 400 Series.

Z

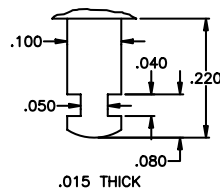

Solder lug terminal

C

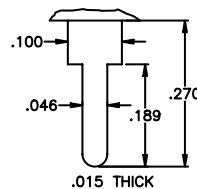

Printed circuit terminal

E (standard)

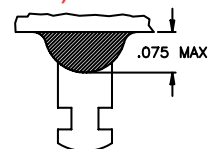

Epoxy seal

300 & 400 SERIES - MINIATURE PUSHBUTTON SWITCHES

Solder lug terminals - snap-in bezel with outboard LED



401SZQEJ6168

POWER CKT. MODEL NO.	DRY CKT. MODEL NO.	UL MODEL NO.	ELECTRICAL FUNCTION
301SZQEJ6168	301SZBEJ6168	301SZQEJ6168/UL	MOM. S.P N.O. w/overtravel
302SZQEJ6168	302SZBEJ6168	302SZQEJ6168/UL	MOM. S.P N.O. no overtravel
303SZQEJ6168	303SZBEJ6168	303SZQEJ6168/UL	MOM. S.P N.C. w/pretravel
304SZQEJ6168	304SZBEJ6168	304SZQEJ6168/UL	MOM. S.P N.C. no pretravel
305SZQEJ6168	305SZBEJ6168	305SZQEJ6168/UL	MOM. S.P N.O. w/overtravel
401SZQEJ6168	401SZBEJ6168	401SZQEJ6168/UL	S.P Alternate snap-action
402SZQEJ6168	402SZBEJ6168	402SZQEJ6168/UL	MOM. S.P N.O. (snap-action)

RECOMMENDED PANEL CUTOUT
Panel thickness range - .047-.125

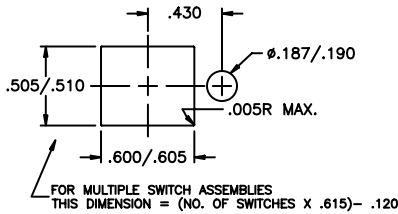

MODEL NO.	DIM. A	DIM. B
301	.108	.929
302	.085	.817
303	.085	.929
304	.085	.817
305	.108	.929
401	.145	1.142
402	.145	1.142

LED leads - 31/32" min. long
Anode (front) - white
Cathode (back) - black

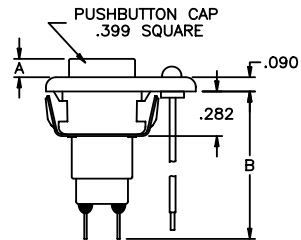
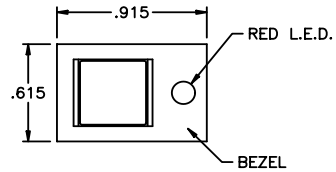

Solder lug terminals - snap-in bezel

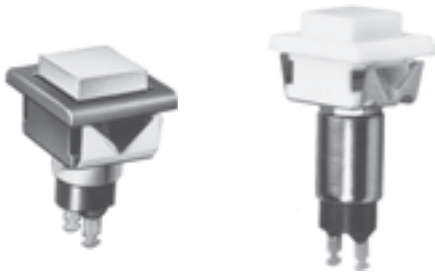

302SZQEJ8168

401SZQEJ8188

POWER CKT. MODEL NO.	DRY CKT. MODEL NO.	UL MODEL NO.	ELECTRICAL FUNCTION
301SZQEJ8168	301SZBEJ8168	301SZQEJ8168/UL	MOM. S.P N.O. w/overtravel
302SZQEJ8168	302SZBEJ8168	302SZQEJ8168/UL	MOM. S.P N.O. no overtravel
303SZQEJ8168	303SZBEJ8168	303SZQEJ8168/UL	MOM. S.P N.C. w/pretravel
304SZQEJ8168	304SZBEJ8168	304SZQEJ8168/UL	MOM. S.P N.C. no pretravel
305SZQEJ8168	305SZBEJ8168	305SZQEJ8168/UL	MOM. S.P N.O. w/overtravel
401SZQEJ8168	401SZBEJ8168	401SZQEJ8168/UL	S.P Alternate snap-action
402SZQEJ8168	402SZBEJ8168	402SZQEJ8168/UL	MOM. S.P N.O. (snap-action)

RECOMMENDED PANEL CUTOUT
Panel thickness range - .047-.125

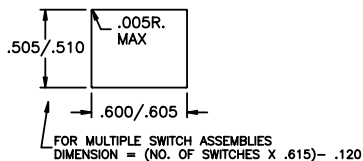

MODEL NO.	DIM. A	DIM. B
301	.108	.929
302	.085	.817
303	.085	.929
304	.085	.817
305	.108	.929
401	.145	1.142
402	.145	1.142

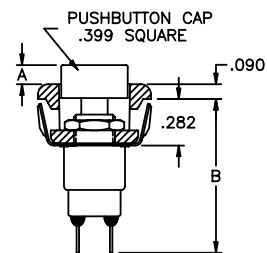
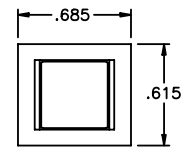

SPECIFICATIONS SUBJECT TO CHANGE WITHOUT NOTICE

300 & 400 SERIES - MINIATURE PUSHBUTTON SWITCHES

Straight p.c. terminals - p.c. mounting bezel



302SV30BEJ8488

DRY CKT. MODEL NO.	ELECTRICAL FUNCTION
301SV30BEJ8488	MOM. S.P N.O. w/overtravel
302SV30BEJ8488	MOM. S.P N.O. no overtravel
305SV30BEJ8488	MOM. S.P N.O. w/added overtravel

MODEL NO.	OPTION*	DIM. A	DIM. B	DIM. C	DIM. D	DIM. E
301S	V30	.100	.900	.780	.527	.237
301S	V40	.100	1.020	.900	.647	.118
302S	V30	.070	.900	.780	.527	.125
302S	V40	.070	1.020	.900	.647	.357
305S	V30	.100	.900	.780	.527	.237
305S	V40	.100	1.020	.900	.647	.118

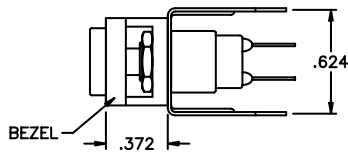
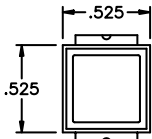
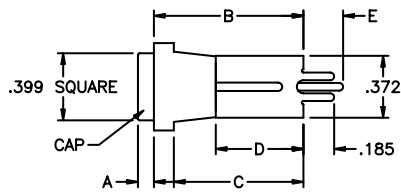

*Options V31 & V41 also available. They are the same as V30 & V40 respectively, except with crimped leg design for p.c. board retention, as shown.

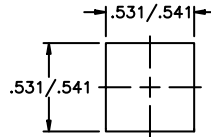
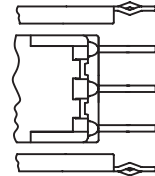

PANEL CUTOUT

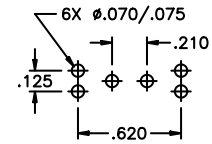

P.C. LAYOUT

Right angle p.c. terminals - p.c. mounting bezel



302SV-1BEJ8488

DRY CKT. MODEL NO.	ELECTRICAL FUNCTION
301SV-1BEJ8488	MOM. S.P N.O. w/overtravel
302SV-1BEJ8488	MOM. S.P N.O. no overtravel
305SV-1BEJ8488	MOM. S.P N.O. w/added overtravel
401SV-1BEJ8488	S.P Alternate action w/ tactile response
402SV-1BEJ8488	MOM. S.P N.O. w/ tactile response

MODEL NO.	OPTION	DIM. A	DIM. B	DIM. C	DIM. D	DIM. E	DIM. F
301S	V	.100	.960	1.080	.550	.150	.190
301S	V-1	.100	.910	1.030	.550	.100	.190
302S	V	.070	.860	.980	.450	.150	.190
302S	V-1	.070	.810	.930	.450	.100	.190
305S	V	.100	.960	1.080	.550	.150	.190
305S	V-1	.100	.910	1.030	.550	.100	.190
401S & 402S	V	.130	1.222	1.342	.750	.150	.220
401S & 402S	V-1	.130	1.172	1.292	.750	.100	.220

Notes: Terminals are not fully bent, to facilitate spring retention in p.c. board.

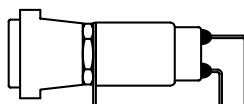
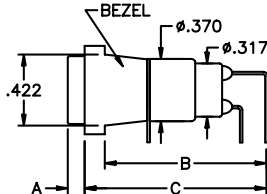
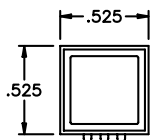
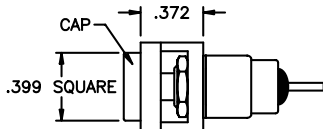

401 & 402 ONLY

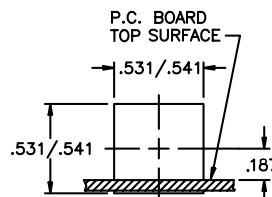

PANEL CUTOUT

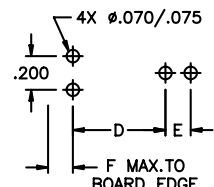

P.C. LAYOUT

300 & 400 SERIES - MINIATURE PUSHBUTTON SWITCHES

Snap-in bezel for round hole mounting
Self-keying against rotation

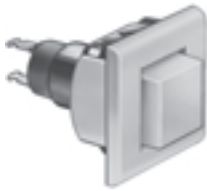

POWER CKT. MODEL NO.	DRY CKT. MODEL NO.	UL MODEL NO.	ELECTRICAL FUNCTION
301SZQEJ9688	301SZBEJ9688	301SZQEJ9688/UL	MOM. S.P N.O. w/overtravel
302SZQEJ9688	302SZBEJ9688	302SZQEJ9688/UL	MOM. S.P N.O. no overtravel
303SZQEJ9688	303SZBEJ9688	303SZQEJ9688/UL	MOM. S.P N.C. w/pretravel
304SZQEJ9688	304SZBEJ9688	304SZQEJ9688/UL	MOM. S.P N.C. no pretravel
305SZQEJ9688	305SZBEJ9688	305SZQEJ9688/UL	MOM. S.P N.O. w/overtravel
401SZQEJ9688	401SZBEJ9688	401SZQEJ9688/UL	S.P Alternate snap-action
402SZQEJ9688	402SZBEJ9688	402SZQEJ9688/UL	MOM. S.P N.O. (snap-action)

302SZQEJ9688

MODEL NO.	DIM. A	DIM. B
301	.108	.929
302	.085	.817
303	.085	.929
304	.085	.817
305	.108	.929
401 & 402	AS SHOWN	

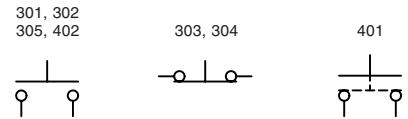
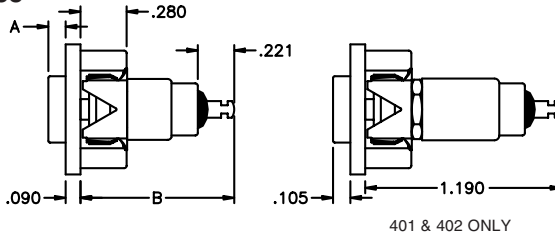

RECOMMENDED PANEL CUTOUTS

Panel thickness range - .047 - .125

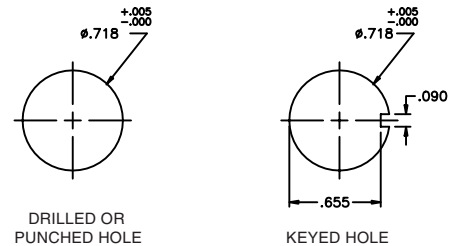
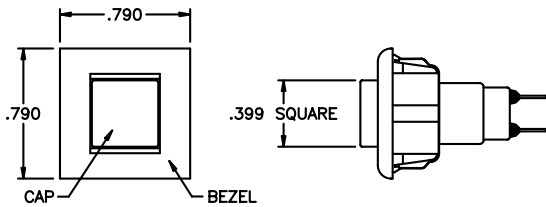

OPTIONS FOR SELECTIVE MODELS ONLY

Options V30 & V40 Straight p.c. terminals w/bracket

For models 301, 302 & 305 only

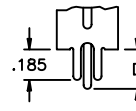
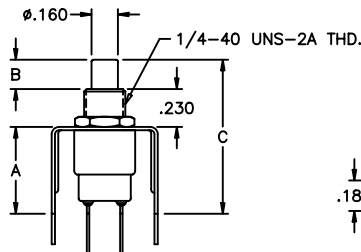
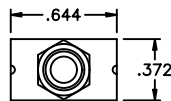

MODEL NO.	*OPTION	DIM. A	DIM. B	DIM. C	DIM. D
301,305	V30	.527	.173	.933	.237
301,305	V40	.647	.173	1.053	.118
302	V30	.527	.150	.910	.125
302	V40	.647	.150	1.030	.357

* Options V31 and V41 with crimped leg design also available - see prior page.

TO SPECIFY, ADD OPTION FROM BOX TO SWITCH MODEL NO. - EXAMPLE: 302V31BE

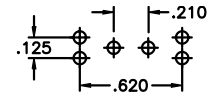

P.C. BOARD LAYOUT

Options V & V-1 Right angle terminals w/bracket

For models 301, 302, 305, 401 & 402 only

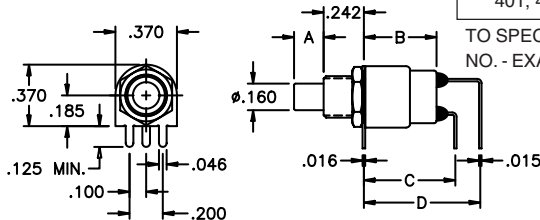
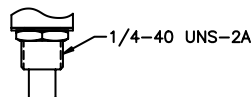

MODEL NO.	OPTION	DIM. A	DIM. B	DIM. C	DIM. D
301, 305	V	.173	.439	.550	.700
301, 305	V-1	.173	.439	.550	.650
302	V	.150	.327	.450	.600
302	V-1	.150	.327	.450	.550
401, 402	V	.210	.653	.750	.900
401, 402	V-1	.210	.653	.750	.850

TO SPECIFY, ADD OPTION FROM BOX TO SWITCH MODEL NO. - EXAMPLE: 301V-1BE

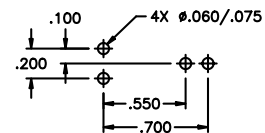

P.C. BOARD LAYOUT

Support Bracket is Brass, Solder Coated.
Available with B, N, or T Contact Materials.
(See pg. C29)

Supplied with Epoxy Sealed Terminals.

Note: Terminals are not fully bent, to facilitate spring retention in p.c. board.

SPECIFICATIONS SUBJECT TO CHANGE WITHOUT NOTICE

300 & 400 SERIES - MINIATURE PUSHBUTTON SWITCHES

OPTIONS FOR SELECTIVE MODELS ONLY

Option T1 15/32" bushing mounts from front or rear of panel
For models 301, 303 & 305 only

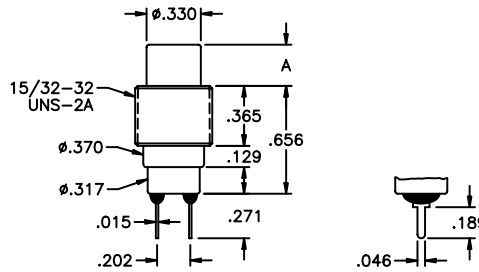

MODEL NO.	A
301,305	.250
303	.225

TO SPECIFY, ADD 'T1' TO SWITCH MODEL NO. - EXAMPLE: 301T1CQE6

Threaded bushing: Brass, nickel plated
Actuator button: Nylon. Specify color - see order format.

Supplied with 2 Hex Nuts, p/n A465 & 1 Lockwasher, p/n A466 (see Hardware section of catalog).

Printed circuit or solder lug terminals available.

Option S Long actuator
For models 301, 302, 303, 304, 305, 401 & 402 only

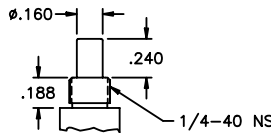

301 & 305

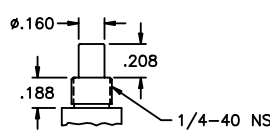

302, 303 & 304

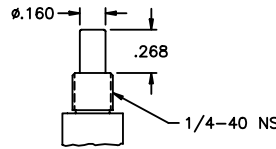

401 & 402

TO SPECIFY, ADD 'S' TO SWITCH MODEL NO. - EXAMPLE: 301SCQE

Actuator: Nylon

Color: Black standard for 300 Series

White standard for 400 Series.

Other colors available - see options.

NOTE: When using sealing boot U5321 with 400 Series switches, add 'S1' to model number. This option is not illustrated.

Additional ordering information: Commonly ordered models are shown above and on prior pages with complete model numbers and specifications. Below is an order format that enables you to 'build your own switch' and specify the correct switch model number by simply selecting from all available options shown and filling in the boxes.

'BUILD YOUR OWN SWITCH' ORDER FORMAT

Fill in boxes with selections shown for **Model Structure**, then add **Options** selections for complete model number. Allowable options are shown below each respective box with brief description - see option dwgs. & info. following. Notes: 'NONE' indicates box may be left empty. Not all combinations can be made - see other pages of Series.

Model Structure:

Series	Actuators	Bushings	Terminations	Contact materials	Sealing
<input style="width: 20px; height: 20px;" type="text"/> <input style="width: 20px; height: 20px;" type="text"/> <input style="width: 20px; height: 20px;" type="text"/>	<input style="width: 20px; height: 20px;" type="text"/>	<input style="width: 20px; height: 20px;" type="text"/>	<input style="width: 20px; height: 20px;" type="text"/> <input style="width: 20px; height: 20px;" type="text"/>	<input style="width: 20px; height: 20px;" type="text"/>	<input style="width: 20px; height: 20px;" type="text"/>
3 0 1 (NONE) 3 0 2 S Long (see 3 0 3 dwg. - specify 3 0 4 for all models 3 0 5 with bezels- 3 0 6 not available 4 0 1 for 306). 4 0 2 S 1 For 400 Series switches used with sealing boot U5321 only.	(NONE) T 1 15/32" thd'd. (see dwg - for 301, 303 & 305 only).	Z Solder lug C Printed circuit V Right angle p.c. term- V - 1 inals for 301, 302, 305, 401 & 402 only (see dwg.). V 3 0 Straight p.c. terminals V 4 0 with bracket for 301, V 4 0 302 & 305 only V 4 1 (see dwg.).	B Gold Q Coin silver (Not avail- able with 303 & 304) N Economy gold T Economy silver	E Epoxy terminal seal is standard	

Options:

Bezel & cap	Bezel color	Cap color	Recognitions
<input style="width: 20px; height: 20px;" type="text"/> <input style="width: 20px; height: 20px;" type="text"/> <input style="width: 20px; height: 20px;" type="text"/>	<input style="width: 20px; height: 20px;" type="text"/>	<input style="width: 20px; height: 20px;" type="text"/>	<input style="width: 20px; height: 20px;" type="text"/> <input style="width: 20px; height: 20px;" type="text"/> <input style="width: 20px; height: 20px;" type="text"/>
(NONE) J 6 1 Snap-in w/LED J 8 1 Snap-in no LED J 8 4 P.C. style J 9 6 Snap-in (round hole)	(NONE) 2 Black 6 Red 8 White Other Colors Available	(NONE) 2 Black 6 Red 8 White Other Colors Available	(NONE) /U L

Switch caps for switches without bezels also available - see Hardware section of catalog.

Example of completely specified model number:
301SZQEJ8122/UL

Although most combinations of options are available, some may result in incompatibilities. Consult factory if there is any question.

SPECIFICATIONS SUBJECT TO CHANGE WITHOUT NOTICE



300 & 400 SERIES - MINIATURE PUSHBUTTON SWITCHES

CONTACT MATERIAL OPTIONS

- B** Dry circuit - gold over nickel over brass.
 RATING: 0.4 Volt-Amps (VA) max. at 20 V max.
 ELECTRIC LIFE: 250,000 cycles minimum.
- Q** Power circuit - coin silver.
 RATING: 1 Amp at 120 VAC or 28 VDC or 0.5 Amps at 250 VAC. ELECTRIC LIFE: 250,000 cycles minimum at full load.
 Also - 3 Amps at 120 VAC or 28 VDC or 1.5 Amps at 250 VAC. ELECTRIC LIFE: 10,000 cycles minimum at full load.
 Dry circuit or power circuit - gold over nickel over coin silver.
- G** Dry circuit - gold over nickel over coin silver.
 RATINGS & ELECTRIC LIFE: Same as B & Q above -i.e.- can be used in either dry circuit or power circuit, however once used in power circuit, switch cannot be re-used in dry circuit. This option permits customers to inventory one switch to satisfy either application,
- N** RATING: 0.4 Volt-Amps (VA) max. at 20 V max. Note- less gold than B option.
 ELECTRIC LIFE: 10,000 cycles min. at 13 cycles per minute.
- T** Power circuit - Silver plate over brass.
 RATING: 0.5 Amps at 120 VAC or 0.25 Amps at 250 VAC (resistive loads).
 ELECTRIC LIFE: 10,000 cycles min. at 13 cycles per minute.

Solder dipped terminals and custom contact plating available - contact factory.

UL OPTION

- /UL** For power circuits - coin silver
 RATING: 0.5 Amps at 250 VAC (75% power factor).
 Underwriter Laboratories file no. E66367. Note - applicable only to terminations with coin silver contacts (Q or G options).

HARDWARE

HARDWARE SUPPLIED

(See Hardware section of catalog)

Panel mounted 300 Series switches with threaded 1/4" bushing are supplied with 1 Hex Nut A112 and 1 Lockwasher A115.

Panel mounted 300 Series switches with threaded 15/32" bushing are supplied with 2 Hex Nuts A465 and 1 Lockwasher A466.

Panel mounted 306 Series switches with threaded 5/16" bushing are supplied with 1 Hex Nut A713 and 1 Lockwasher A734.

Panel mounted 400 Series switches with threaded bushing are supplied with 1 Panel Dress Nut A274 and 1 Lockwasher A115.

PANEL CUT-OUTS

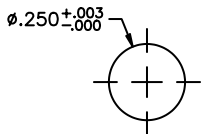

Accepts all 1/4" threaded bushings

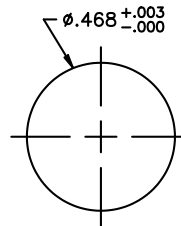

Accepts all 15/32" threaded bushings

SPECIFICATIONS SUBJECT TO CHANGE WITHOUT NOTICE

MPB SERIES PUSHBUTTON SWITCHES

FEATURES

- Single pole single throw momentary action.
- Normally open and normally closed models.
- Permanent cap is standard.
- Single hole mounting w/mtg. nut & lk'wshr supplied.

MATERIALS

Base: PBT thermoplastic, color black
 Bushing: Brass, nickel plated
 Actuator: ABS thermoplastic
 Terminals: Brass, silver plated
 Shorting Contact: Brass or phos. brz., silver plated

GENERAL SPECIFICATIONS

ELECTRICALS

Contact rating: 300 mA @ 125 VAC
 Insulation resistance: 100 megohms min. (500 VDC)
 Dielectric withstanding voltage: 500 VAC for 1 minute
 Contact resistance: 25 milliohms max. at 1 amp, 5 VDC
 Electrical/Mechanical life: 10,000 cycles min.
 Contact bounce: less than 10 milliseconds

MECHANICALS, THERMALS

Plunger travel: MPB1110: .063" (1.6mm) MPB1140: .078" (2mm)
 Actuation force: 300 grams \pm 150 grams
 Operating temperature range: -20 °C to +60 °C

SOLDERING

Wave or hand soldering: 235°C max. for 5 seconds max.
 Solvent washing: Non-washable. Do not apply flux to terminals or switch mtg. surface

SPECIFICATIONS SUBJECT TO CHANGE WITHOUT NOTICE

C

MPB1110



NORMALLY OPEN



SCHEMATIC

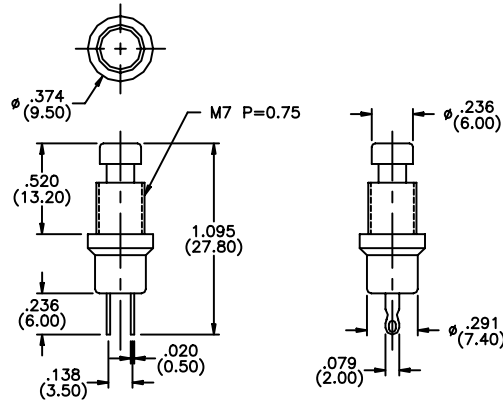

MECHANICAL OUTLINE

Model No.	Cap Color
MPB11102	Black
MPB11106	Red

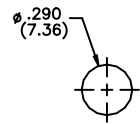

TOLERANCE FOR PANEL
 MTG. HOLE: $+0.005$ (0.13)
 -0.000 (0.00)

PANEL MTG. HOLE

MPB1140



NORMALLY CLOSED



SCHEMATIC

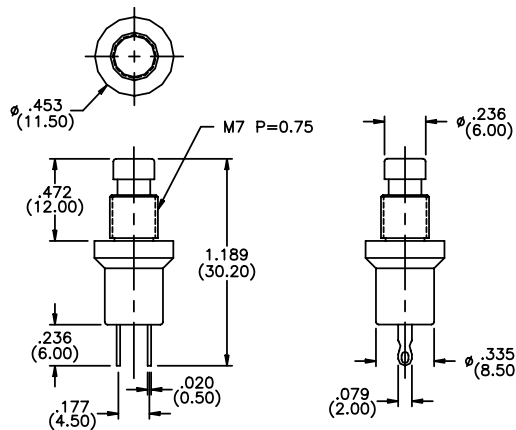

MECHANICAL OUTLINE

Model No.	Cap Color
MPB11402	Black
MPB11406	Red

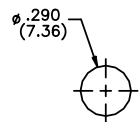

TOLERANCE FOR PANEL
 MTG. HOLE: $+0.005$ (0.13)
 -0.000 (0.00)

PANEL MTG. HOLE

IP SERIES - PUSHBUTTON SWITCHES FOR HARSH ENVIRONMENTS



C

FEATURES

- Single pole NO or NC/NO combined momentary actions with double break.
- Totally sealed compact construction, illuminated or non-illuminated.
- Ergonomically sculptured bezels with colorful actuator selections.
- Excellent tactile feedback with precise actuation

ELECTRICAL AND GENERAL SPECIFICATIONS

Contact ratings (resistive loads):	500 mA at 48 VAC, 200 mA at 50 VDC or 200 mA at 250 VAC
Initial contact resistance:	50 milliohms maximum
Insulation resistance:	1 gigohm min. at 500 VDC
Dielectric strength:	1500 V rms min.
Electrical life:	500,000 cycles min. at full load
Mechanical life:	1,000,000 cycles min.
Total Travel:	.059" (1.5mm)
Operating force:	10.5 ±4 oz. (3±1 N)
Contact bounce:	10 milliseconds
Panel thickness:	.059"-.157" (1.5-4mm)

ENVIRONMENTAL SPECIFICATIONS

Degree of protection:	IP 67
Shock resistance:	100g per IEC 512-4, test 6c
Vibration resistance:	10-500 Hz, 10g per IEC 512-4, test 6d
Salt spray:	Per IEC 512-6, test 11f
Robustness (non-illum. models):	IK06 per EN 50102
Operating temperature range:	-40°C to +125°C

MATERIALS

Contacts :	Gold plated silver
Actuator:	Polyamide 6/6
Bushing/bezel:	Zamac (black painted)
Case:	PBT UL94V-0
Terminal seal:	Epoxy
Lens:	Polycarbonate
Wire leads (F models):	Stranded, 20 AWG, UL approved
Hardware:	Supplied with 1 Hex Nut .551" (14mm) across flats and 1 'o'ring

LED SPECIFICATIONS

Super red:	Forward current 20mA, luminous intensity up to 125 mcd
Yellow:	Forward current 20mA, luminous intensity up to 125 mcd
Green:	Forward current 10mA, luminous intensity up to 20 mcd

A resistor must be series connected by the user. LED terminals are tin plated for ease of solderability.

SPECIFICATIONS SUBJECT TO CHANGE WITHOUT NOTICE

IP SERIES - PUSHBUTTON SWITCHES FOR HARSH ENVIRONMENTS

Round - solder lug terminals - non-illuminated



MODEL NO.	ACT. COLOR
N/O	
IPR3SAD2	BLACK
IPR3SAD6	RED
IPR3SAD7/1	WHITE
NC/NO combined <i>New!</i>	
IPR5SAD2	BLACK
IPR5SAD6	RED
IPR5SAD7/1	WHITE

→ Flat

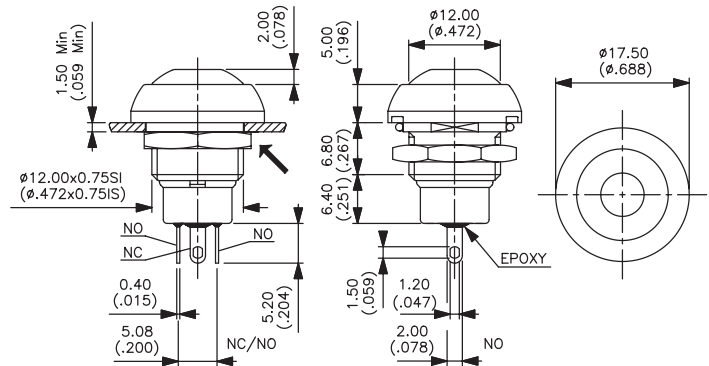

Round - stranded 20 AWG wire leads - non-illuminated



MODEL NO.	ACT. COLOR
N/O	
IPR3FAD2	BLACK
IPR3FAD6	RED
IPR3FAD7/1	WHITE
NC/NO combined <i>New!</i>	
IPR5FAD2	BLACK
IPR5FAD6	RED
IPR5FAD7/1	WHITE

→ Flat

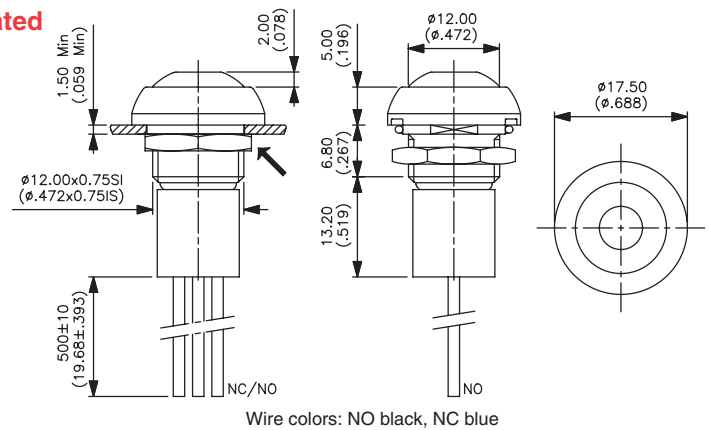

Square - solder lug terminals - non-illuminated



MODEL NO.	ACT. COLOR
N/O	
IPC3SAD2	BLACK
IPC3SAD6	RED
IPC3SAD7/1	WHITE
NC/NO combined <i>New!</i>	
IPC5SAD2	BLACK
IPC5SAD6	RED
IPC5SAD7/1	WHITE

→ Flat

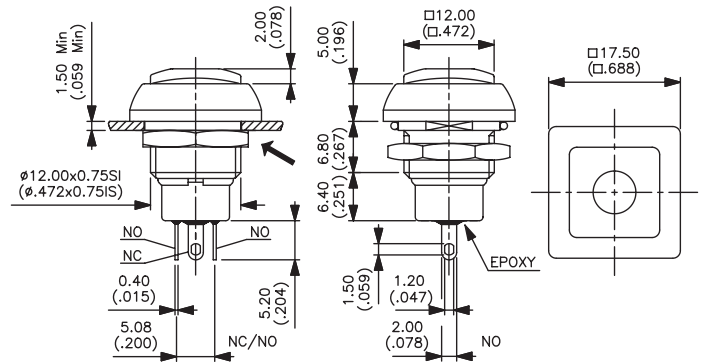

Square - stranded 20 AWG wire leads - non-illuminated



MODEL NO.	ACT. COLOR
N/O	
IPC3FAD2	BLACK
IPC3FAD6	RED
IPC3FAD7/1	WHITE
NC/NO combined <i>New!</i>	
IPC5FAD2	BLACK
IPC5FAD6	RED
IPC5FAD7/1	WHITE

→ Flat

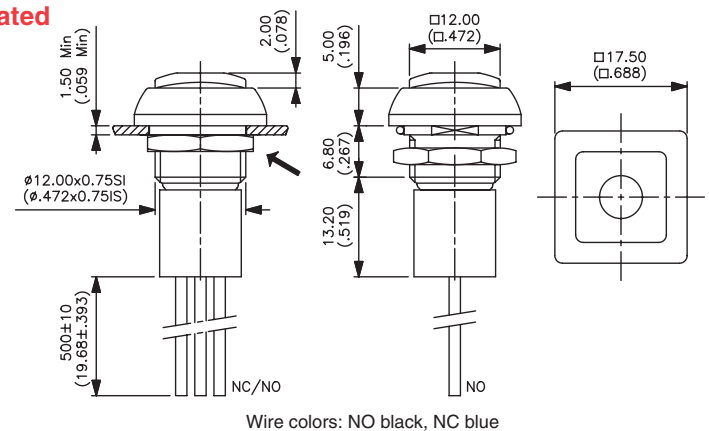

SPECIFICATIONS SUBJECT TO CHANGE WITHOUT NOTICE

C

New! IP SERIES - PUSHBUTTON SWITCHES FOR HARSH ENVIRONMENTS

C

Round - solder lug terminals - illuminated



MODEL NO.	ACT. COLOR
N/O	
IPR3SAD2L0S	BLACK
IPR3SAD6L0S	RED
IPR3SAD7/1L0S	WHITE

Above models have super red LED

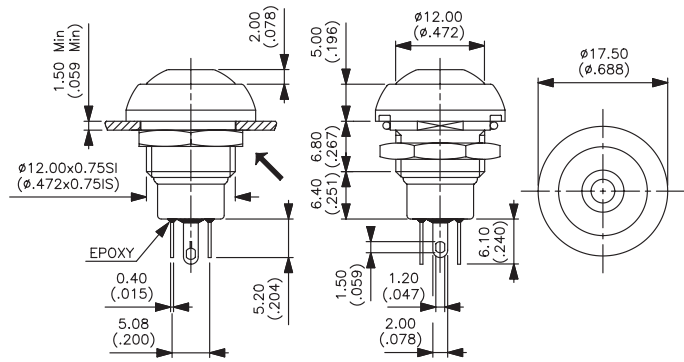

→ Flat

Round - stranded 20 AWG wire leads - illuminated



MODEL NO.	ACT. COLOR
N/O	
IPR3FAD2L0S	BLACK
IPR3FAD6L0S	RED
IPR3FAD7/1L0S	WHITE

Above models have super red LED

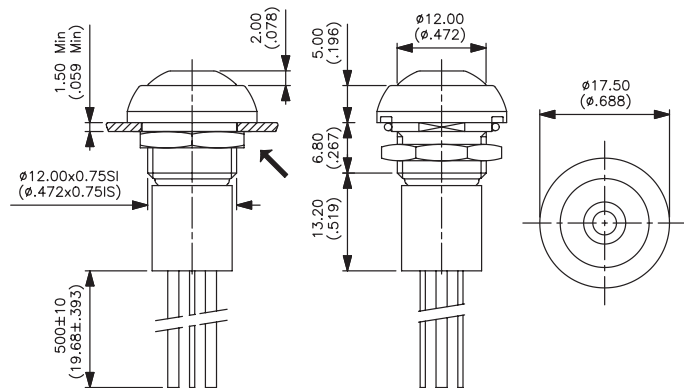

→ Flat

Wire colors: NO black, LED anode (+) red, LED cathode (-) blue

Square - solder lug terminals - illuminated



MODEL NO.	ACT. COLOR
N/O	
IPC3SAD2L0S	BLACK
IPC3SAD6L0S	RED
IPC3SAD7/1L0S	WHITE

Above models have super red LED

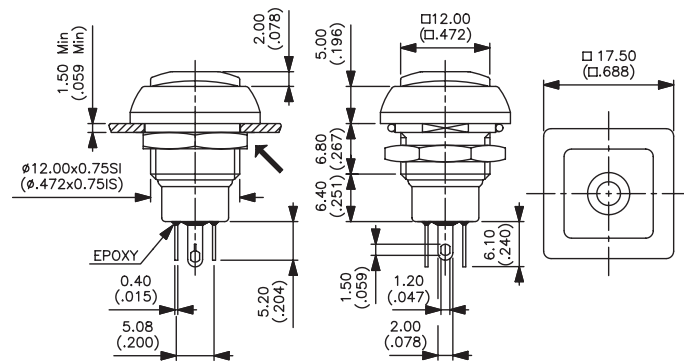

→ Flat

Square - stranded 20 AWG wire leads - illuminated

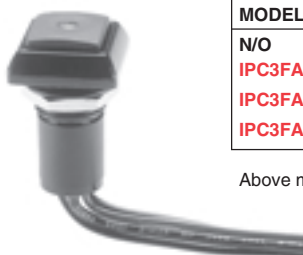

MODEL NO.	ACT. COLOR
N/O	
IPC3FAD2L0S	BLACK
IPC3FAD6L0S	RED
IPC3FAD7/1L0S	WHITE

Above models have super red LED

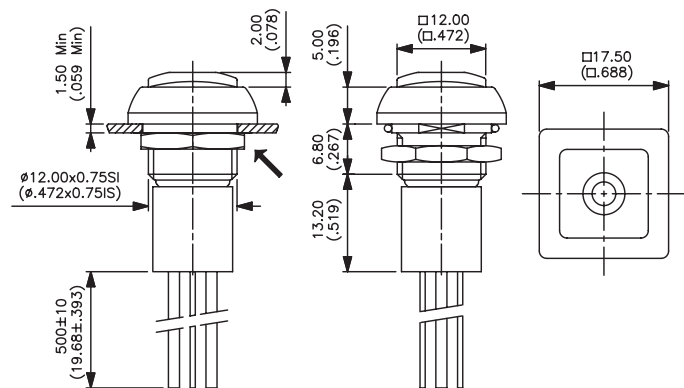

→ Flat

Wire colors: NO black, LED anode (+) red, LED cathode (-) blue

SPECIFICATIONS SUBJECT TO CHANGE WITHOUT NOTICE

IP SERIES - PUSHBUTTON SWITCHES FOR HARSH ENVIRONMENTS

Additional ordering information: Commonly ordered models are shown on prior page with complete model numbers and specifications. Below is an order format that enables you to 'build your own switch' and specify the correct switch model number by simply selecting from all available options shown and filling in the boxes.

'BUILD YOUR OWN SWITCH' ORDER FORMAT

Fill in boxes with allowable options shown below each respective box.

Series	Bezel shape	Electrical function	Terminals	Contacts	Actuator color	LED color
I P	<input type="checkbox"/>	<input type="checkbox"/>	<input type="checkbox"/>	<input type="checkbox"/> <input type="checkbox"/>	<input type="checkbox"/> <input type="checkbox"/> <input type="checkbox"/>	<input type="checkbox"/> <input type="checkbox"/> <input type="checkbox"/>
	R Round C Square	3 Normally open (NO) 5 NC/NO combined (non-illum.)	S Solder lugs F Stranded wire leads	Gold plated silver	1 Blue 2 Black 3 Green 5 Yellow 6 Red 7 / 1 White 9 Orange	(NONE) Non-illum. L 0 S Super red L 0 Y Yellow L 0 G Green

MOUNTING

Panel cut-out

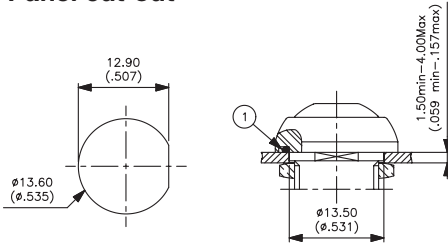

Matrix mounting

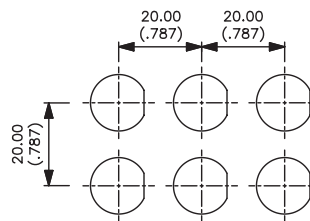

Back of panel space requirement

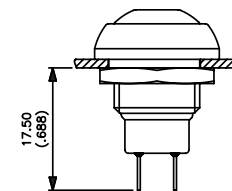

MISCELLANEOUS

Operating force vs. travel diagram

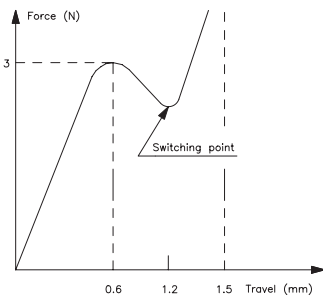

Switch cross sections

seals 1 & 2, elastomer membrane & O-ring are typical.

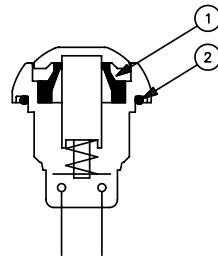

Function 3 (NO) non-illum

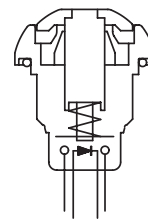

Function 3 (NO) illuminated

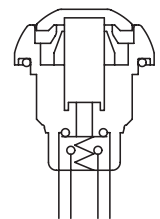

Function 5 (NC/NO)

SEALING

Per IP 67. Degree of protection provided by the enclosures of electric appliances according to IEC 529, DIN 40050 & NFC 20-010 shown below:

IP
(ingress protection)

6
Totally protected against dust

7
Protected against the effects of immersion up to 1 meter of water (30 mins.)

SOLDER LUG VERSION

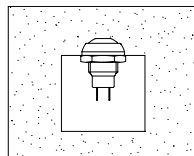

WIRE LEADS VERSION

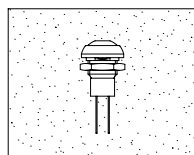

Illustrations show non-illuminated models only.

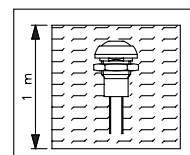
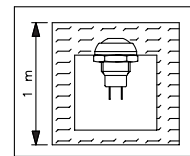

New! IP SERIES - PUSHBUTTON SWITCHES FOR HARSH ENVIRONMENTS

LED LUMINANCE MEASUREMENT MODE

TEST RESULTS*

LED types	Luminance	Forward current
LOS (super red)	4500 Cd/m ²	20mA
LOY (yellow)	5000 Cd/m ²	20mA
LOG (green)	500 Cd/m ²	10mA

* - in our lab conditions

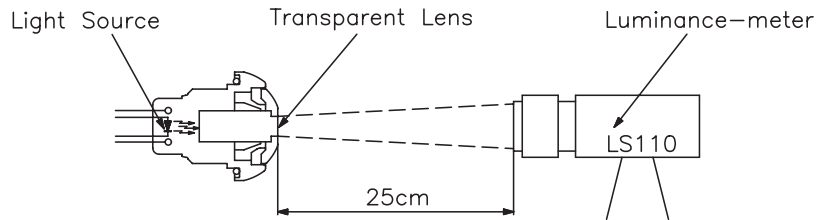

TEST CONDITIONS: Measured in a dark room

ADDITIONAL SEALING

For round units only, illuminated or non-illuminated.

Transparent silicone overboot **U5125** (transparent) or **U5125-2** (black) for protection against frost and abrasion by sand. Order separately.

Operating temperature: -40°C to 125°C.

Note: The switches remain sealed to IP67 even if the boot is eventually perforated.

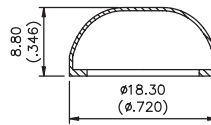

U5125

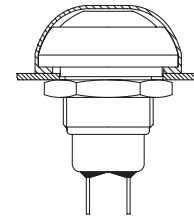

SPECIFICATIONS SUBJECT TO CHANGE WITHOUT NOTICE

New! IB & IS SERIES - SEALED MINIATURE PUSHBUTTON SWITCHES



FEATURES

- Single pole NO momentary action with double break.
- Totally sealed compact construction with behind-the-panel depth of only .512" (13mm) .
- Ergonomically sculptured bezels with colorful actuator selections.
- Excellent tactile feedback with precise actuation
- Flat top on actuator allows marking

ELECTRICAL AND GENERAL SPECIFICATIONS

Contact ratings (resistive loads):	400 mA at 32 VAC, 100 mA at 50 VDC or 125 mA at 125 VAC
Initial contact resistance:	50 milliohms maximum
Insulation resistance:	1 gigohm min. at 500 VDC
Dielectric strength:	1000 V rms min.
Electrical life:	500,000 cycles min. at full load
Mechanical life:	1,000,000 cycles min.
Total Travel:	.059" (1.5mm)
Operating force:	10.5 ±4 oz. (3±1 N)
Contact bounce:	10 millisecond
Panel thickness:	IB: .031"-.071" (0.8-1.8mm) IS: .059"-.157" (1.5-4mm)

ENVIRONMENTAL SPECIFICATIONS

Degree of protection:	IP 67
Shock resistance:	100g per IEC 512-4, test 6c
Vibration resistance:	10-500 Hz, 10g per IEC 512-4, test 6d
Salt spray:	Per IEC 512-6, test 11f
Operating temperature range:	-40°C to +125°C

MATERIALS

Contacts :	Gold plated silver
Actuator:	Polyamide 6/6
Bushing/bezel:	Polyamide 6/6
Case:	Thermoplastic UL94V-0
Terminal seal:	Epoxy
Hardware:	IB: Supplied with 1 flat seal IS: Supplied with 1 Hex Nut .551" (14mm) across flats and 1 flat seal.

New! IB & IS SERIES - SEALED MINIATURE PUSHBUTTON SWITCHES

Round - snap-in mounting



MODEL NO.	ACT. COLOR
Normally open	
IBR3SAD2	BLACK
IBR3SAD6	RED
IBR3SAD7/1	WHITE

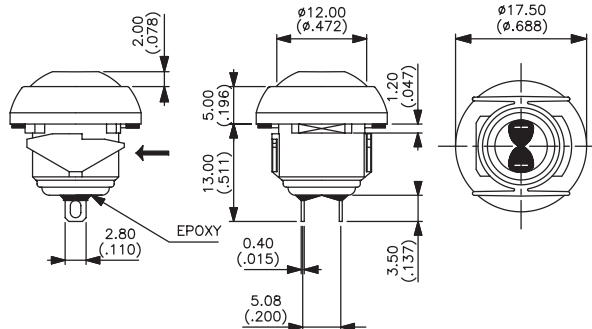

→ Flat

.Panel thickness: .031" (0.8mm) to .071" (1.8mm)

Round - threaded bushing mounting



MODEL NO.	ACT. COLOR
Normally open	
ISR3SAD2	BLACK
ISR3SAD6	RED
ISR3SAD7/1	WHITE

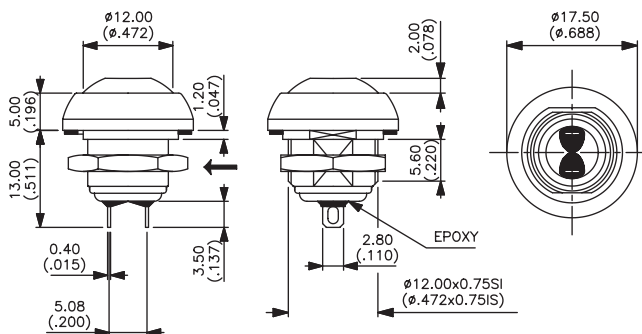

→ Flat

.Panel thickness: .059" (1.5mm) to .157" (4mm)

Additional ordering information: Commonly ordered models are shown on prior page with complete model numbers and specifications. Below is an order format that enables you to 'build your own switch' and specify the correct switch model number by simply selecting from all available options shown and filling in the boxes.

'BUILD YOUR OWN SWITCH' ORDER FORMAT

Fill in boxes with allowable options shown below each respective box.

Series	Bezel shape	Electrical function	Terminals	Contacts	Actuator color	Bushing & bezel finish
<input type="text"/>	R	3	S	A D	<input type="text"/>	<input type="text"/>
I B Snap-in I S Threaded bushing	Round	Normally open (NO)	Solder lugs	Gold plated silver	1 Blue 2 Black 3 Green 5 Yellow 6 Red 7 / 1 White 9 Orange	0 0 Black (std) 0 8 Chrome plated (IS only) 1 0 White

MISCELLANEOUS

Operating force vs. travel diagram

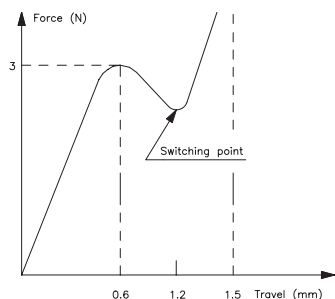

Switch cross section

- ① Elastomer membrane seal
- ② Flat panel seal

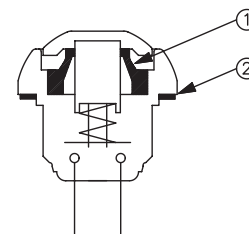

Function 3 (NO)

New! IB & IS SERIES - SEALED MINIATURE PUSHBUTTON SWITCHES

IB SERIES MOUNTING

Panel cut-out

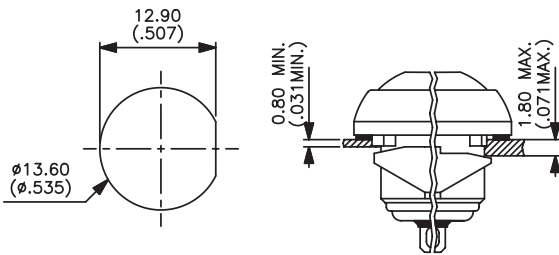

Matrix mounting

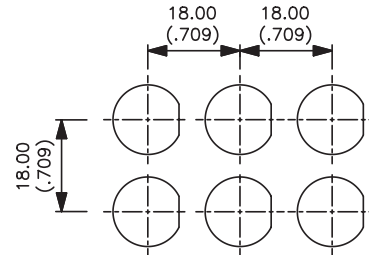

IS SERIES MOUNTING

Panel cut-out

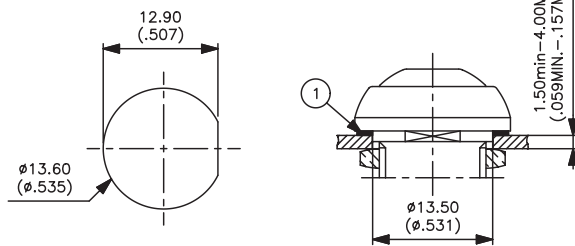

Matrix mounting

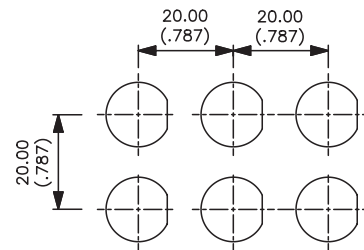

ADDITIONAL SEALING

For round units only, illuminated or non-illuminated.

Transparent silicone overboot **U5125** (transparent) or **U5125-2** (black) for protection against frost and abrasion by sand. Order separately.

Operating temperature: -40°C to 125°C.

Note: The switches remain sealed to IP67 even if the rated.

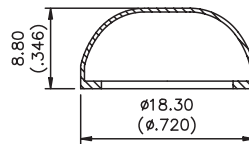

U5125

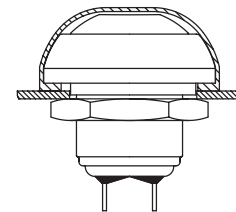

SPECIFICATIONS SUBJECT TO CHANGE WITHOUT NOTICE

C

SP SERIES - WASHABLE MINIATURE SNAP-ACTION PUSHBUTTON SWITCHES



FEATURES

- Wave solderable.
- Compact case size & fully sealed for process compatibility.
- SPDT & DPDT momentary p.c. & panel mounting models.
- Models available with ESD protection up to 12 KV.

SPECIFICATIONS

Contact ratings (resistive loads):	Gold plated brass: 100 mA at 30 VDC Silver or gold plated silver: 1 Amp at 120 VAC or 30 VDC
Initial contact resistance:	50 milliohms maximum
Insulation resistance:	1000 megohms minimum
Dielectric strength:	1000 V rms minimum
Electrical life:	60,000 cycles minimum
Operating temperature range:	-20°C to +85°C
Washing:	Permissible with water, detergents and solvents.

MATERIALS

Contacts & Terminals:	Gold plated brass, silver or gold plated silver
Actuator:	UL94V-0 polyamide, glass filled
Bracket:	Tin plated steel
Case:	UL94V-0 polyamide, glass filled or PES
Terminal seal:	Epoxy
Hardware:	1/4" threaded bushing models supplied with 2 Hex Nuts .314" (8mm) across flats, 1 Locking Ring & 1 Lockwasher. See hardware section of catalog.

AGENCY RECOGNITION



Available with all models with silver or gold plated silver contacts and terminals, standard actuator and smooth bushing. UL marking supplied when specified - see Order Format.

Plain bushing - straight p.c. terminals - gold plated brass contacts



SINGLE POLE	CIRCUIT
MODEL NO. SP35P000000	ON MOM
DOUBLE POLE	CIRCUIT
MODEL NO. SP45P000000	ON MOM
Button position:	
Terminals connected:	1-3 1-2

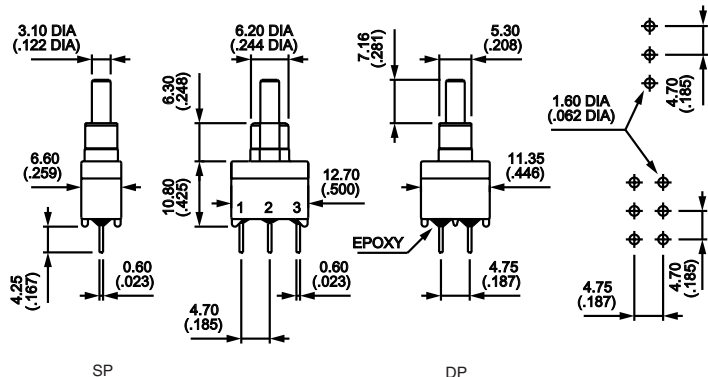

SPECIFICATIONS SUBJECT TO CHANGE WITHOUT NOTICE

SP SERIES - WASHABLE MINIATURE SNAP-ACTION PUSHBUTTON SWITCHES

Plain bushing - bracket mounting - gold plated brass contacts



SINGLE POLE	CIRCUIT
MODEL NO. SP35Y000000	ON MOM
DOUBLE POLE	CIRCUIT
MODEL NO. SP45Y000000	ON MOM
Button position:	
Terminals connected: 1-3 1-2	

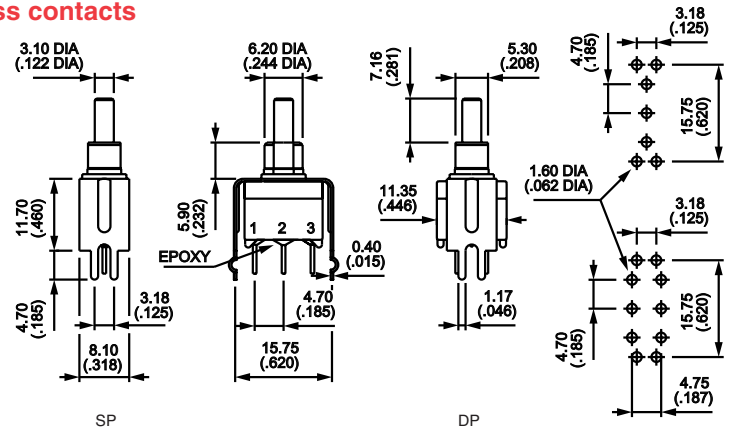

Plain bushing - horizontal right angle terminals - gold plated brass contacts



SINGLE POLE	CIRCUIT
MODEL NO. SP35W000000	ON MOM
DOUBLE POLE	CIRCUIT
MODEL NO. SP45W000000	ON MOM
Button position:	
Terminals connected: 1-3 1-2	

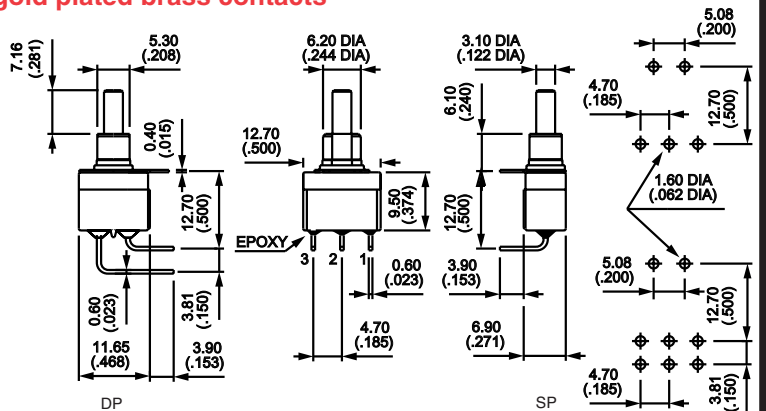

Plain bushing - vertical right angle terminals - gold plated brass contacts



SINGLE POLE	CIRCUIT
MODEL NO. SP35WW000000	ON MOM
DOUBLE POLE	CIRCUIT
MODEL NO. SP45WW000000	ON MOM
Button position:	
Terminals connected: 1-3 1-2	

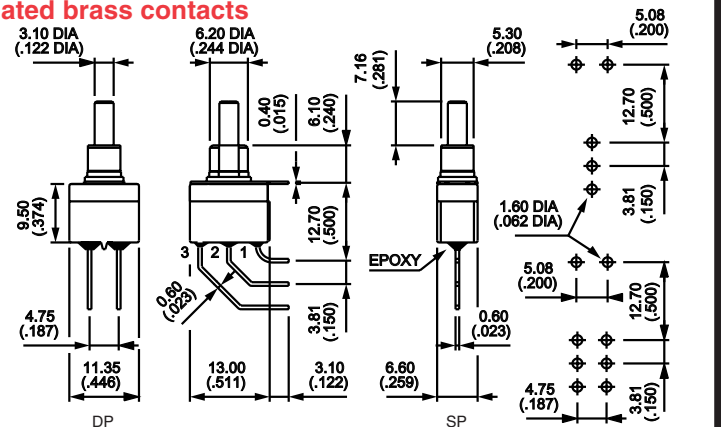

Threaded bushing - solder lug terminals - gold plated brass contacts



SINGLE POLE	CIRCUIT
MODEL NO. SP35S000077	ON MOM
Button position:	
Terminals connected: 1-3 1-2	

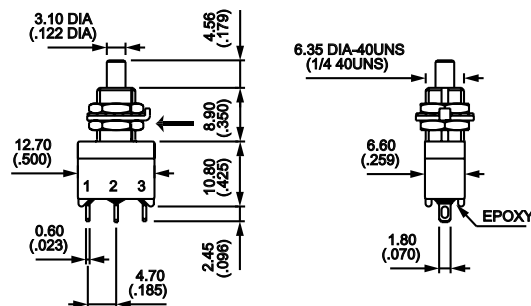

→ Keyway

SPECIFICATIONS SUBJECT TO CHANGE WITHOUT NOTICE



SP SERIES - WASHABLE MINIATURE SNAP-ACTION PUSHBUTTON SWITCHES

Threaded bushing - straight p.c. terminals - gold plated brass contacts



SINGLE POLE	
MODEL NO.	CIRCUIT
SP35P000077	ON MOM
Button position:	
Terminals connected:	
1-3	1-2

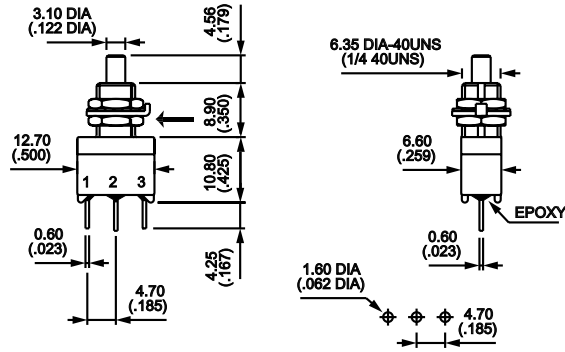

→ Keyway

Additional ordering information: Commonly ordered models are shown above with complete model numbers and specifications. Below is an order format that enables you to 'build your own switch' and specify the correct switch model number by simply selecting from all available options shown and filling in the boxes.

'BUILD YOUR OWN SWITCH' ORDER FORMAT

Fill in boxes with selections shown for **Model Structure**, then add **Options** selections for complete model number. (Allowable options are shown under each respective box).

Model Structure:

Series	Number of poles	Electrical function	Terminals
S P	<input type="text"/>	<input type="text"/>	<input type="text"/>
	3 Single pole 4 Double pole	5 ON MOM	P 0 Straight pc S 0 Solder lug Y 0 Straight pc with mounting bracket W 0 Horizontal right angle mounting W W Vertical right angle mounting

Options:

Contact & terminal materials

- 0 Brass, gold plated
- 1 Silver
- 2 Silver, gold plated
- 8 Brass, gold plated, with, tin plated terminals

Actuators and bushings

- 0 0 0 0 Standard actuator w/smooth bushing
 - 0 0 0 1 Standard actuator w/smooth bushing & UL marking (UL available with silver or gold plated silver contacts & terminals only)
 - 0 0 7 7 Standard actuator w/threaded bushing
 - 0 2 7 6 Short actuator w/short smooth bushing
- (See actuator/ bushing drawings at bottom of this page)

Example of completely specified model number: **SP35Y080000**

Caps available separately - see option drawings on next page.

OPTION DRAWINGS

ACTUATOR/BUSHING DRAWINGS

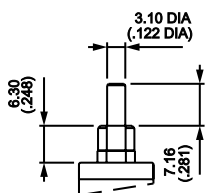

0000 Standard actuator w/smooth bushing

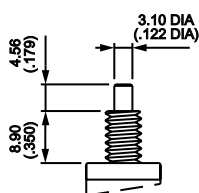

0077 Standard actuator w/threaded bushing

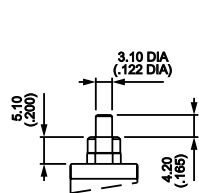

0276 Short actuator with short smooth bushing

TERMINAL OUTLINES

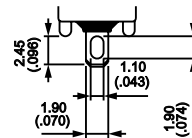

S0 Solder lug

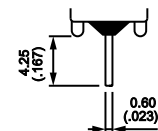

P0 Straight printed circuit

SP SERIES - WASHABLE MINIATURE SNAP-ACTION PUSHBUTTON SWITCHES

OPTION DRAWINGS & MISCELLANEOUS

CAPS Note: replace last '0' in p/n with color code.

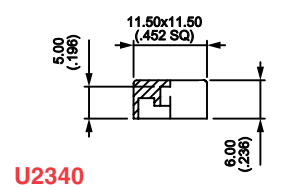
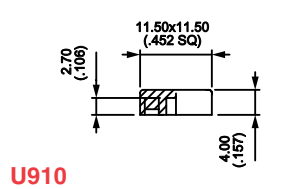
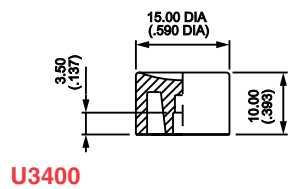
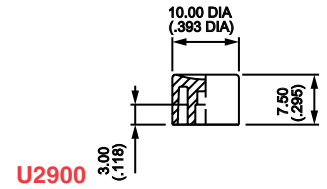
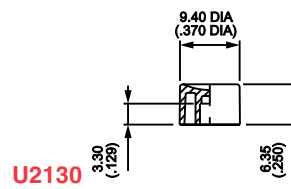
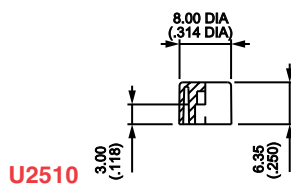
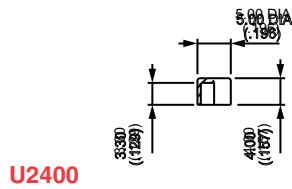

Colors	
1	blue
2	black
3	green
4	grey
5	yellow
6	red
7/1	white
9	orange

DRESS NUTS Chrome plated For threaded bushing models only.

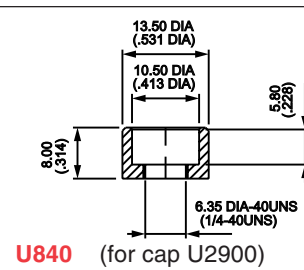
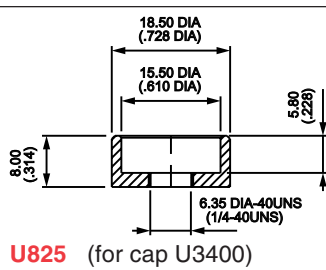
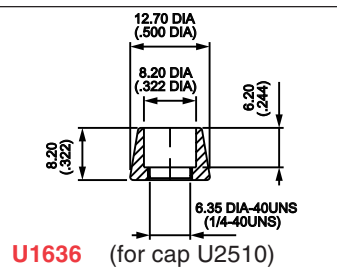

PANEL CUT-OUT

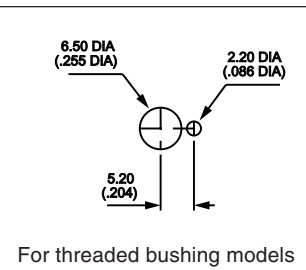

ELECTROSTATICALLY PROTECTED PUSHBUTTON SWITCHES

INSULATED

Protects against electrostatic discharges (ESD) up to 12 KV.

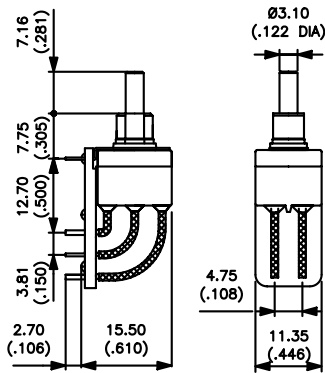

X978 - Consult factory

SPECIFICATIONS SUBJECT TO CHANGE WITHOUT NOTICE

C

18000 SERIES - MINIATURE SNAP-ACTION MOMENTARY PUSHBUTTON SWITCHES

C

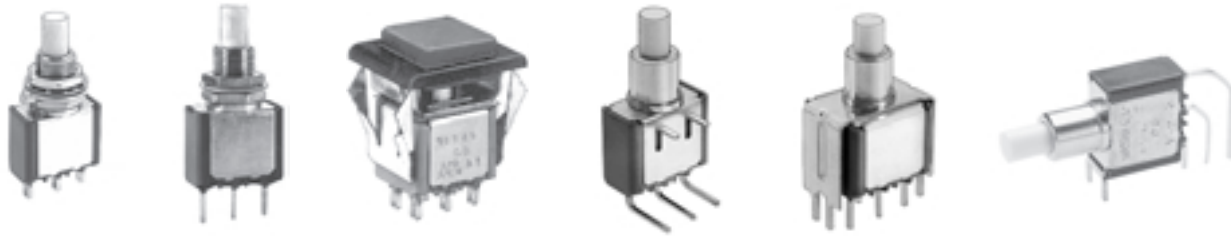

FEATURES

- Single pole-double throw & double pole-double throw models with ON-MOM ON action.
- Epoxy terminal sealing standard.
- Panel and p.c. mounting models with compact miniature case size.

SPECIFICATIONS

Contact ratings (resistive loads):	Gold plated brass: 100 mA at 30 VDC Gold plated silver: 1A at 120VAC or 30VDC
Initial contact resistance:	50 milliohms maximum
Insulation resistance:	1000 megohms minimum
Dielectric strength:	1000 V rms minimum
Electrical life:	60,000 cycles minimum at full load.
Operating temperature range:	-30°C to +65°C
Total travel:	.019" (0.5mm)

MATERIALS

Contacts & Terminals:	Gold plated brass or gold plated silver
Actuator:	Polyamide, glass filled
Bushing:	Nickel plated brass
Housing:	Stainless steel
Case:	Diallyl phthalate
Bracket:	Tin plated steel
Terminal seal:	Epoxy
Hardware:	1/4" threaded bushing models supplied with 2 Hex Nuts .314" (8mm) across flats, 1 Locking Ring & 1 Lockwasher. See hardware section of catalog.

ABOUT THIS SERIES

The material is organized in the following sequence:
 a. completely specified switch models.
 b. 'Build your own switch' order format.
 c. Options & miscellaneous

Solder lug terminals - 1/4" (6.35mm) bushing - gold plated silver contacts



SINGLE POLE		CIRCUIT	
MODEL NO.		ON	MOM
18535AD			
DOUBLE POLE		CIRCUIT	
MODEL NO.		ON	MOM
18545AD			
Handle position:			
Terms. connected:		1-3 4-6	1-2 4-5

→ Keyway

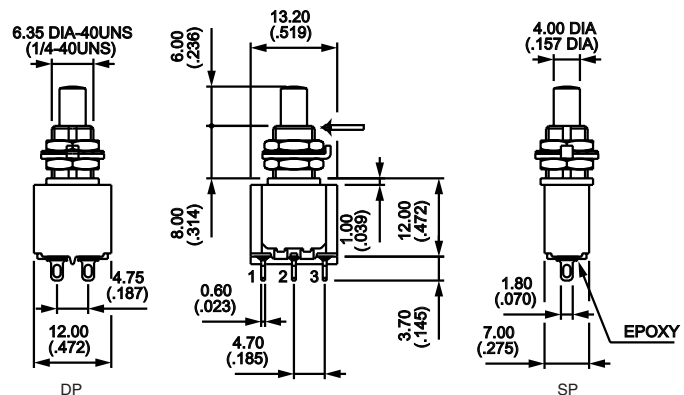

SPECIFICATIONS SUBJECT TO CHANGE WITHOUT NOTICE

18000 SERIES - MINIATURE SNAP-ACTION MOMENTARY PUSHBUTTON SWITCHES

Solder lug terminals - 1/4" (6.35mm) flatted bushing - gold plated silver contacts



SINGLE POLE MODEL NO.	CIRCUIT	
18735AD	ON	MOM
DOUBLE POLE MODEL NO.	CIRCUIT	
18745AD	ON	MOM
Handle position:		
Terms. connected:	1-3 4-6	1-2 4-5

→ 'D' flat

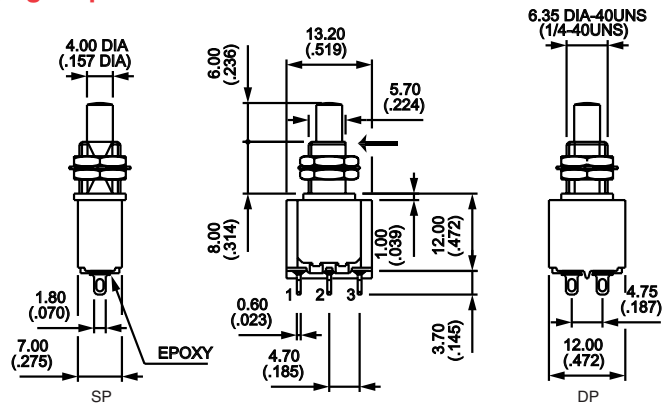

Straight p.c. terminals - 1/4" (6.35mm) bushing - gold plated silver contacts



SINGLE POLE MODEL NO.	CIRCUIT	
18235AD	ON	MOM
DOUBLE POLE MODEL NO.	CIRCUIT	
18245AD	ON	MOM
Handle position:		
Terms. connected:	1-3 4-6	1-2 4-5

→ Keyway

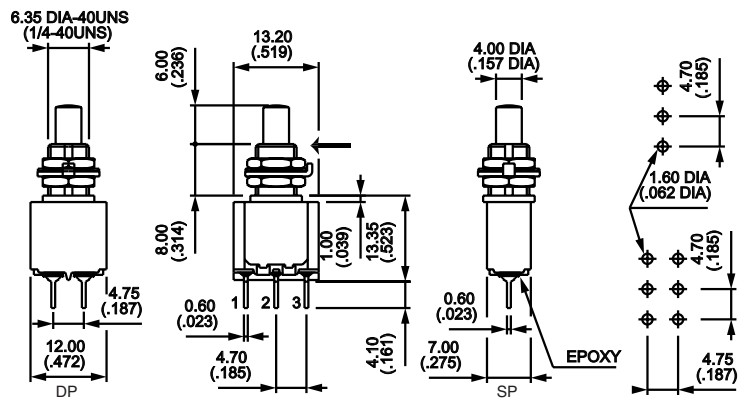

Straight p.c. terminals - 1/4" (6.35mm) flatted bushing - gold plated silver contacts



SINGLE POLE MODEL NO.	CIRCUIT	
18935AD	ON	MOM
DOUBLE POLE MODEL NO.	CIRCUIT	
18945AD	ON	MOM
Handle position:		
Terms. connected:	1-3 4-6	1-2 4-5

→ 'D' flat

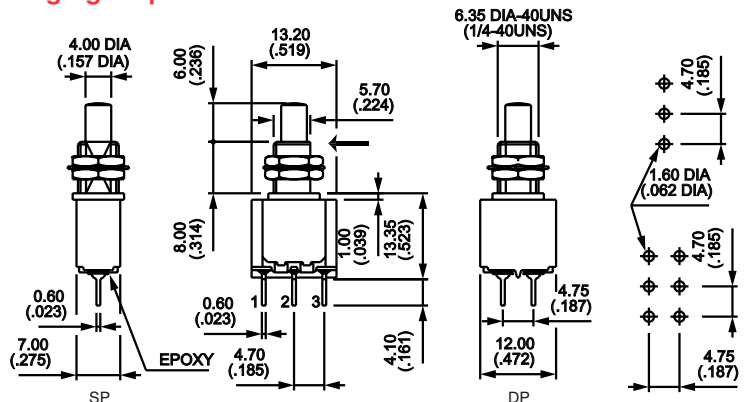

Solder lug terminals - snap-in mounting - gold plated silver contacts



SINGLE POLE MODEL NO.	CIRCUIT	
18835AD+U912+U1202	ON	MOM
DOUBLE POLE MODEL NO.	CIRCUIT	
18845AD+U912+U1202	ON	MOM
Handle position:		
Terms. connected:	1-3 4-6	1-2 4-5

Above models have back bezel & cap

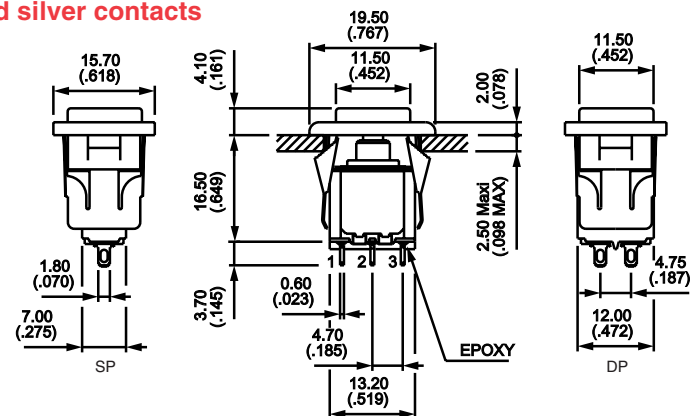

18000 SERIES - MINIATURE SNAP-ACTION MOMENTARY PUSHBUTTON SWITCHES

PANEL CUT-OUTS for models shown above

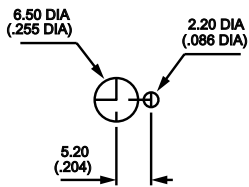

1/4" (6.35mm) bushing

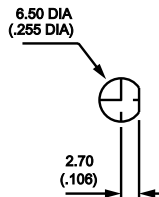

1/4" (6.35mm) flatted bush.

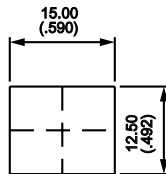

Bezel U1200

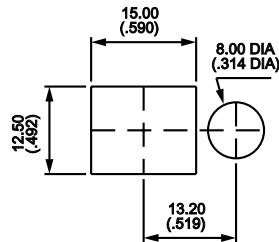

Bezel U1210 w/LED

Single pole - straight p.c. terminals - bracket mounting - gold plated brass contacts



SINGLE POLE	CIRCUIT	
MODEL NO.	ON	MOM
18235YCD3	ON	MOM
Handle position:		
Terms. connected:	1-3	1-2

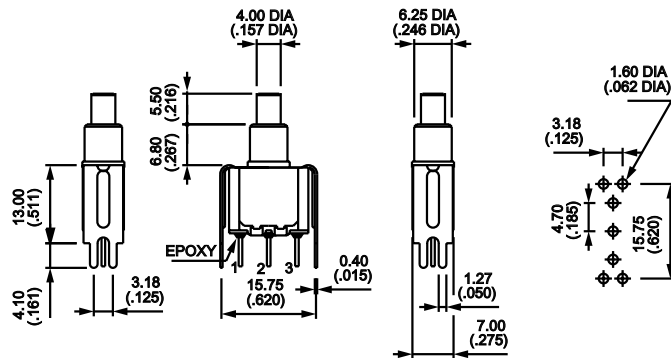

Double pole - straight p.c. terminals - bracket mounting - gold plated brass contacts



DOUBLE POLE	CIRCUIT	
MODEL NO.	ON	MOM
18245YCD3	ON	MOM
Handle position:		
Terms. connected:	1-3 4-6	1-2 4-5

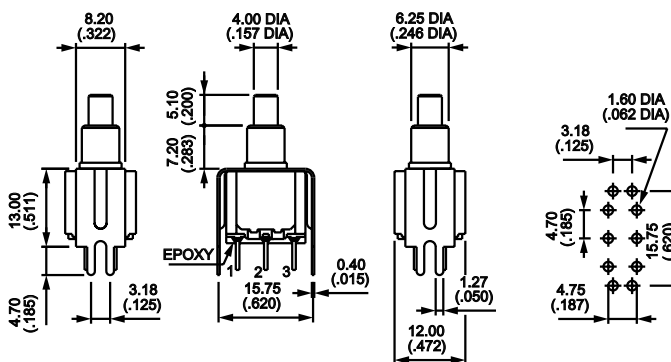

Horizontal right angle p.c. terminals - gold plated brass contacts



SINGLE POLE	CIRCUIT	
MODEL NO.	ON	MOM
18235WCD3	ON	MOM
Handle position:		
Terms. connected:	1-3	1-2

DOUBLE POLE	CIRCUIT	
MODEL NO.	ON	MOM
18245WCD3	ON	MOM
Handle position:		
Terms. connected:	1-3 4-6	1-2 4-5

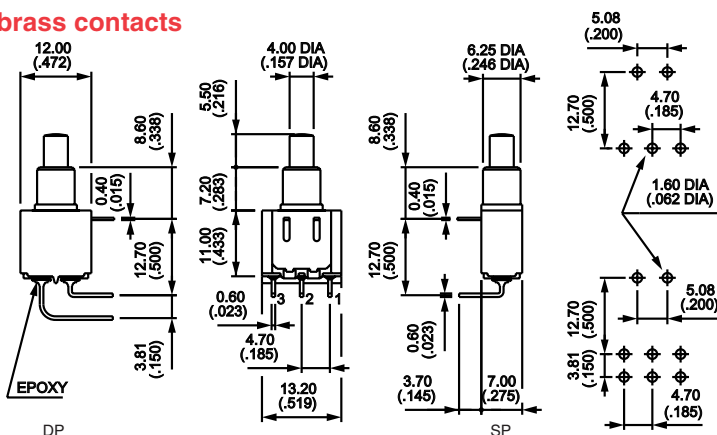

SPECIFICATIONS SUBJECT TO CHANGE WITHOUT NOTICE

18000 SERIES - MINIATURE SNAP-ACTION MOMENTARY PUSHBUTTON SWITCHES

Vertical right angle p.c. terminals - gold plated brass contacts



SINGLE POLE		CIRCUIT					
MODEL NO.	18235WWCD3	ON	MOM				
DOUBLE POLE		CIRCUIT					
MODEL NO.	18245WWCD3	ON	MOM				
Handle position:							
Terms. connected: <table style="display: inline-table; border: none;"><tr><td style="padding: 0 10px;">1-3</td><td>1-2</td></tr><tr><td style="padding: 0 10px;">4-6</td><td>4-5</td></tr></table>				1-3	1-2	4-6	4-5
1-3	1-2						
4-6	4-5						

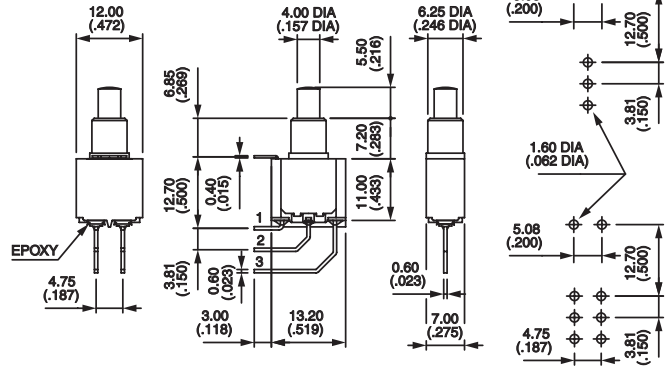

Special option X624 - straight p.c. terminals - short bushing & actuator - gold plated brass contacts



SINGLE POLE		CIRCUIT					
MODEL NO.	18235YCD2X624	ON	MOM				
DOUBLE POLE		CIRCUIT					
MODEL NO.	18245YCD2X624	ON	MOM				
Handle position:							
Terms. connected: <table style="display: inline-table; border: none;"><tr><td style="padding: 0 10px;">1-3</td><td>1-2</td></tr><tr><td style="padding: 0 10px;">4-6</td><td>4-5</td></tr></table>				1-3	1-2	4-6	4-5
1-3	1-2						
4-6	4-5						

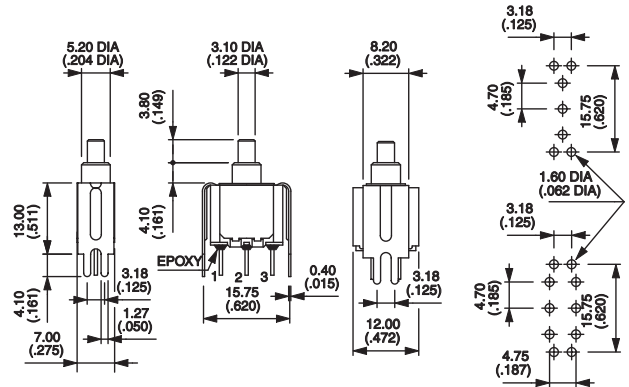

Special option X662 - straight p.c. terminals - snap-in mounting - gold plated brass contacts



SINGLE POLE		CIRCUIT					
MODEL NO.	18835CDX662+U910+U1200	ON	MOM				
DOUBLE POLE		CIRCUIT					
MODEL NO.	18845CDX662+U910+U1200	ON	MOM				
Handle position:							
Terms. connected: <table style="display: inline-table; border: none;"><tr><td style="padding: 0 10px;">1-3</td><td>1-2</td></tr><tr><td style="padding: 0 10px;">4-6</td><td>4-5</td></tr></table>				1-3	1-2	4-6	4-5
1-3	1-2						
4-6	4-5						

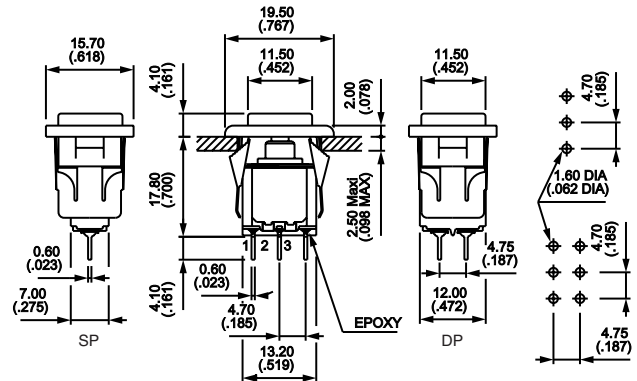

SPECIAL OPTIONS

- F** Tin plated terminals (for p.c. terminals only).
- X371** .246" (6.25mm) smooth bushing in place of standard threaded bushing.
- X372** Short 1/4" (6.35mm) threaded bushing, .274" (7mm) long.
- X386** 1/4" (6.35mm) threaded bushing in place of smooth bushing on models with W, WW & Y options.
- X438** .246" (6.25mm) smooth bushing without shoulder, .283" (7.2mm) long.

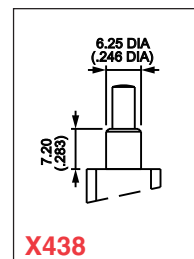
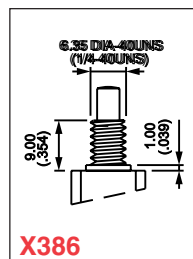
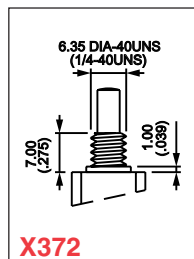
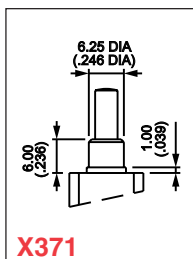

18000 SERIES - MINIATURE SNAP-ACTION MOMENTARY PUSHBUTTON SWITCHES

Additional ordering information: Commonly ordered models are shown above with complete model numbers and specifications. Below is an order format that enables you to 'build your own switch' and specify the correct switch model number by simply selecting from all available options shown and filling in the boxes.

'BUILD YOUR OWN SWITCH' ORDER FORMAT

Fill in boxes with selections shown for **Model Structure**, then add **Options** selections for complete model number. (Allowable options are shown under each respective box).

Note: 'NONE' indicates box may be left empty.

Model Structure:

Series	Terminals & bushings	Number of poles	Electrical function	Terminals
1	8		5	
	2 Straight p.c. terminals with 1/4" (6.35mm) threaded bushing. Straight p.c. terms. + bracket or right angle p.c. terms. with smooth bushing 5 Solder lug terminals with 1/4" (6.35mm) threaded bushing 7 Solder lug terminals with 1/4" (6.35mm) flatted bushing 8 Solder lug terminals, snap-in mounting 9 Straight p.c. terminals with 1/4" (6.35mm) flatted bushing	3 Single pole 4 Double pole	ON - MOM	(NONE) Solder lug or straight p.c. W Horizontal right angle p.c. W W Vertical right angle p.c. Y Bracket mounting

Example of completely specified model number: **18245AD**

Caps available separately - see option drawings.

Options:

Contact materials	Actuators	Special options
<input type="checkbox"/> <input type="checkbox"/>	<input type="checkbox"/> <input type="checkbox"/>	<input type="checkbox"/> <input type="checkbox"/> <input type="checkbox"/> <input type="checkbox"/>
A D Silver, gold plated C D Brass, gold plated	(NONE) .157" (4mm) dia. x .236" (6mm) long (standard) with threaded bushing 6 .122" (3.1mm) dia. x .230" (5.85mm) with threaded bushing 3 .157" (4mm) dia. x .216" (5.5mm) long (standard) with smooth bushing 5 .122" (3.1mm) dia. x .248" (6.3mm) long	(NONE) F Tin plated terminals- for p.c. terms. only X 6 2 4 Shorter bushing & actuator X 6 6 2 Snap-in mounting & straight p.c. terminals Others listed - see Special Option page

Although most combinations of options are available, some may result in incompatibilities. Consult factory if there is any question.

ACTUATOR OPTIONS

(NONE) Standard with threaded bushing		6	3 Standard with smooth bushing		

		<h3>SWITCH ACTION</h3> <p>Arrow indicates keyway</p>	<h3>TERMINALS</h3> <p>Solder lug Straight p.c.</p>
5			

SPECIFICATIONS SUBJECT TO CHANGE WITHOUT NOTICE

18000 SERIES - MINIATURE SNAP-ACTION MOMENTARY PUSHBUTTON SWITCHES

CAPS

FOR .157" (4mm) DIA. ACTUATORS (13 & 3)

Note: replace last '0' in p/n with color code.

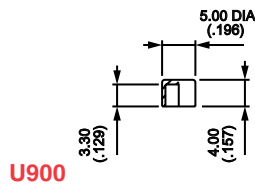

U900

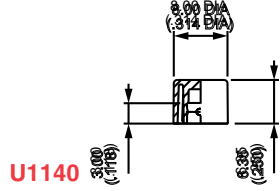

U1140

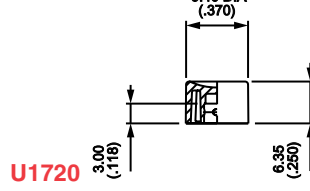

U1720

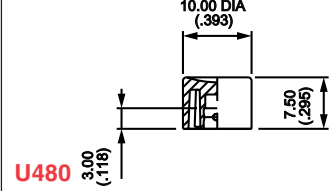

U480

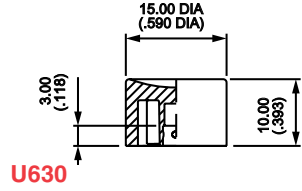

U630

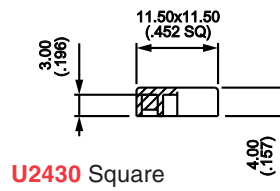

U2430 Square

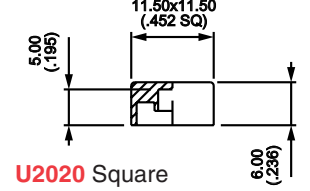

U2020 Square

Colors	
1	blue
2	black
3	green
4	grey
5	yellow
6	red
7	ivory
7/1	white
9	orange

FOR .122" (3.1mm) DIA. ACTUATORS (5 & 6)

Note: replace last '0' in p/n with color code.

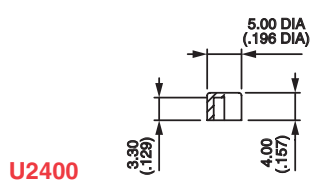

U2400

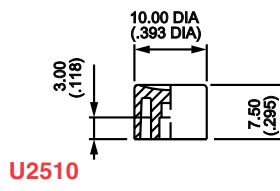

U2510

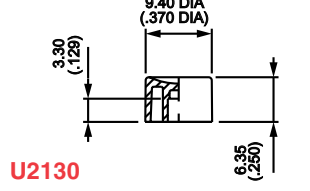

U2130

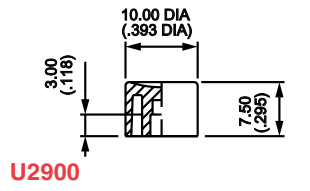

U2900

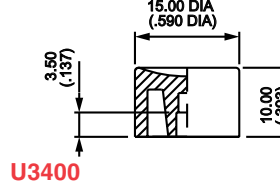

U3400

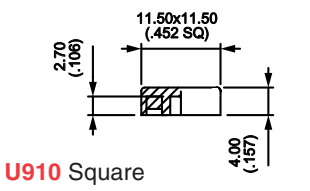

U910 Square

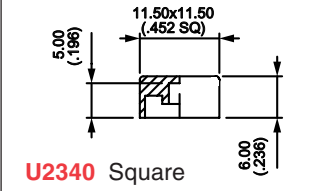

U2340 Square

FOR 188.. & 188..X662 MODELS

Note: replace '0' in p/n with color code.

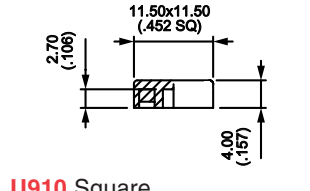

U910 Square

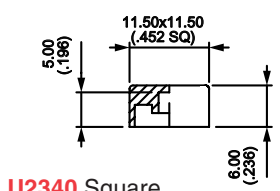

U2340 Square

DRESS NUTS

Chrome plated For models with threaded bushings (182., 185., 187., & 189..) (Order separately)

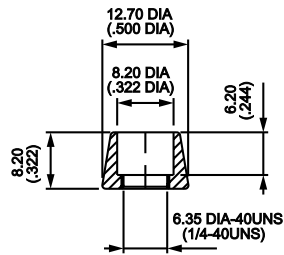

U1636 For caps U1140 & U2510

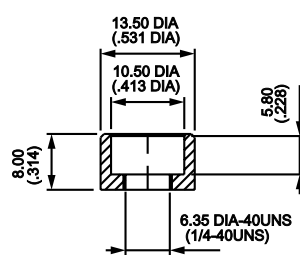

U840 For caps U480 & U2900

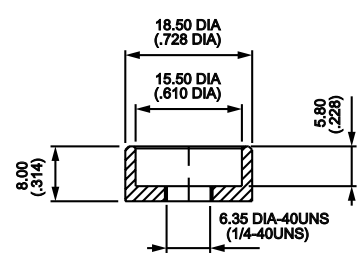

U825 For caps U630 & U3400

SPECIFICATIONS SUBJECT TO CHANGE WITHOUT NOTICE

C

18000 SERIES - MINIATURE SNAP-ACTION MOMENTARY PUSHBUTTON SWITCHES

BEZELS Note: replace last '0' in p/n with color code

For snap-in models (188.. & 188..X662)

For bracket mtg. models (182..Y & 182..YX624)

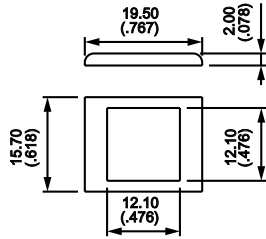

U1200

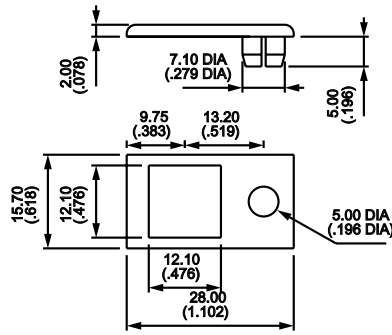

U1210 For LED (not supplied)

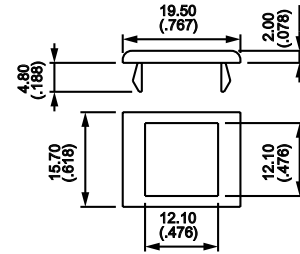

U3200

Colors

- 1 blue
- 2 black
- 3 green
- 4 grey
- 5 yellow
- 6 red
- 7 ivory
- 7/1 white
- 9 orange

STANDARD PANEL MOUNTING FOR BEZELS

Panel thicknesses: .039" (1mm) to .098" (2.5mm)

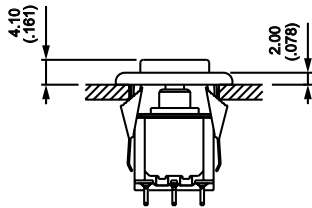

188.. + U910 + U1200

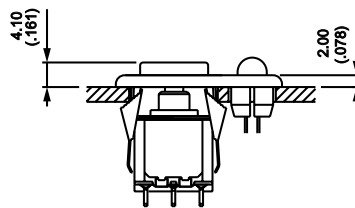

188.. + U910 + U1210

SPECIFICATIONS SUBJECT TO CHANGE WITHOUT NOTICE

8000 SERIES - MINI. MOMENTARY OR ALTERNATE ACTION PUSHBUTTON SWITCHES



FEATURES

- Single pole-double throw & double pole-double throw models.
- ON-MOM and ON-ON alternate actions .
- 1/4-40 and 15/32-32 threaded bushing options.
- Panel and p.c. mounting models with compact miniature case size.

SPECIFICATIONS

Contact ratings (resistive loads):	Gold plated brass: 0.4 Volt-Amps max. at 20 V (AC or DC) Silver: 3A 250VAC, 6A 125VAC or 4A 30VDC
Initial contact resistance:	10 milliohms maximum
Insulation resistance:	1000 megohms minimum at 500 VDC
Dielectric strength:	2000 V rms min. between terminals and frame. 1000 V rms between terminals.
Electrical life:	30,000 cycles minimum at full load.
Operating temperature range:	-40°C to +85°C
Travel:	Pre-travel - .086" (2.2mm) Over-travel - .019" (0.5mm) Total-travel - .106" (2.7mm)
Actuation force:	8432, 8632 & 8646 - 800±300gms. 8436 - 550±150gms. 8442 & 8642 - 1150±150gms. 8446 & 8646 - 750±250gms.

MATERIALS

Contacts & Terminals:	Gold plated brass or gold plated silver
Actuator:	Nickel plated brass
Bushing:	Nickel plated brass
Housing:	Stainless steel
Case:	Diallyl phthalate
Terminal seal:	Epoxy
Hardware:	1/4" threaded bushing models supplied with 2 Hex Nuts .314" (8mm) across flats, 1 Locking Ring & 1 Lockwasher. See hardware section of catalog.

AGENCY LISTINGS



To order switches marked UL, specify in approvals box of Order Format.

Solder lug terminals - 1/4" (6.35mm) bushing - silver contacts



Note: Cap shown must be ordered separately.

SINGLE POLE		CIRCUIT	
MODEL NO.			
8632AB		ON	MOM
8636AB		ON	ON
DOUBLE POLE		CIRCUIT	
MODEL NO.			
8642AB		ON	MOM
8646AB		ON	ON
Actuator position:			
Terms. connected:		2-3	1-2
		5-6	4-5

→ Keyway

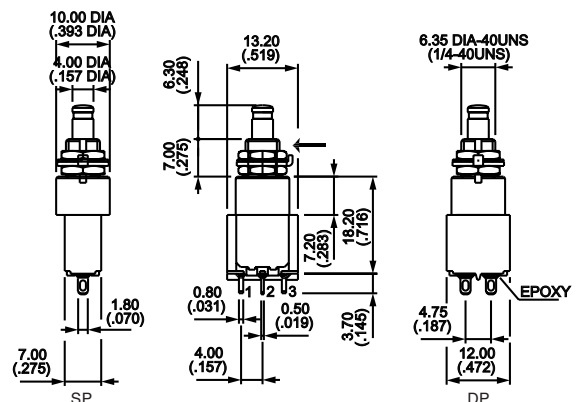

8000 SERIES - MINI. MOMENTARY OR ALTERNATE ACTION PUSHBUTTON SWITCHES

Straight p.c. terminals - 1/4" (6.35mm) bushing - silver contacts



SINGLE POLE		CIRCUIT	
MODEL NO.			
8432AB	ON	MOM	
8436AB	ON	ON	
DOUBLE POLE		CIRCUIT	
MODEL NO.			
8442AB	ON	MOM	
8446AB	ON	ON	

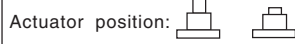

Terms. connected: 2-3 1-2
5-6 4-5

→ Keyway

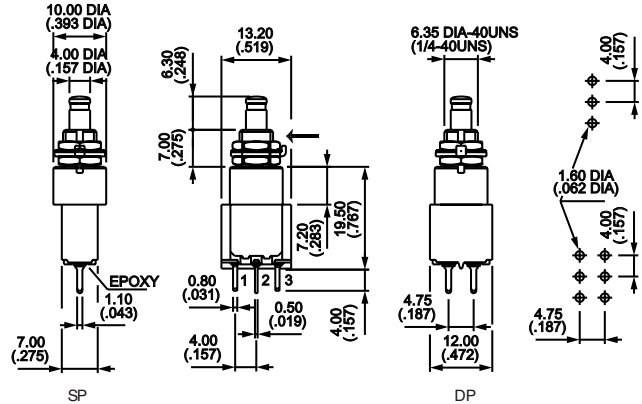

Horizontal right angle p.c. terminals - 1/4" (6.35mm) bushing - gold plated brass contacts



SINGLE POLE		CIRCUIT	
MODEL NO.			
8432WCDB	ON	MOM	
8436WCDB	ON	ON	
DOUBLE POLE		CIRCUIT	
MODEL NO.			
8442WCDB	ON	MOM	
8446WCDB	ON	ON	

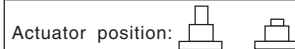

Terms. connected: 2-3 1-2
5-6 4-5

→ Keyway

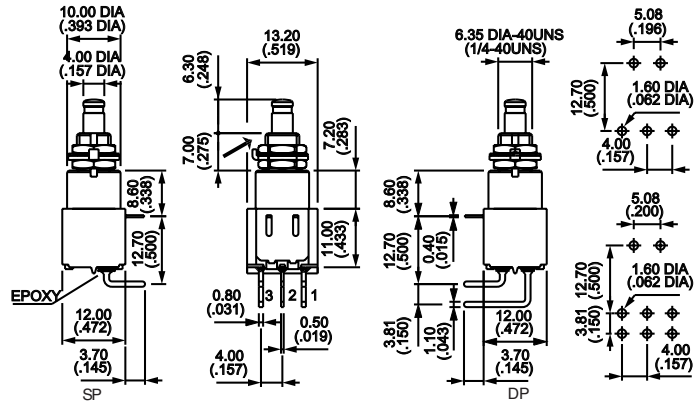

Additional ordering information: Commonly ordered models are shown above with complete model numbers and specifications. Below is an order format that enables you to 'build your own switch' and specify the correct switch model number by simply selecting from all available options shown and filling in the boxes.

'BUILD YOUR OWN SWITCH' ORDER FORMAT

Fill in boxes with selections shown for **Model Structure**, then add **Options** selections for complete model number. (Allowable options are shown under each respective box).
Note: 'NONE' indicates box may be left empty.

Model Structure:

Series	Terminals	Number of poles	Electrical functions	Terminals
<input type="text" value="8"/>	<input type="text"/>	<input type="text"/>	<input type="text"/>	<input type="text"/>
	4 Straight p.c. or right angle terminals 6 Solder lug terminals	3 Single pole 4 Double pole	2 ON - MOM 6 ON - ON	(NONE) Solder lug or straight p.c. W Right angle p.c.

Options:

Contact materials	Actuators	Sealing	Special options	
<input type="text"/>	<input type="text"/>	<input type="text"/>	<input type="text"/>	<input type="text"/>
A Silver A D Silver, gold plated C D Brass, gold plated	For 1/4" (6.35mm) bushings (NONE) Height .248" (6.3mm) 9 Height .346" (8.8mm) For 15/32" (11.9mm) bushings (NONE) Height .338" (8.6mm) 6 Height .275" (7mm)	(NONE) No sealing B Epoxy sealed terminals K Front panel sealing with 'o'-ring & gasket	(NONE) X 7 1 8 15/32" (11.9mm) bushing X 9 3 4 15/32" (11.9mm) bushing & front panel sealing	(NONE) U L

Example of completely specified model number: **8432WCDB**

Caps available separately - see option drawings.

SPECIFICATIONS SUBJECT TO CHANGE WITHOUT NOTICE

8000 SERIES - MINI. MOMENTARY OR ALTERNATE ACTION PUSHBUTTON SWITCHES

ACTUATOR OPTIONS

For 1/4" (6.35mm) bushing

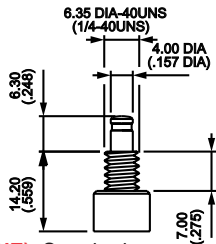

(NONE) Standard

9

For 15/32" (11.9mm) bushing

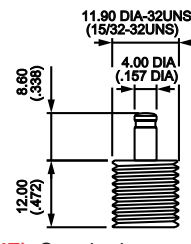

(NONE) Standard

6

MISCELLANEOUS

SWITCH ACTION

Arrow indicates keyway

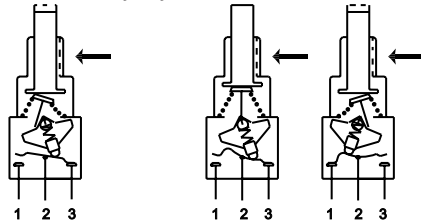

Function 6
(ON-ON)

Function 2
(ON-MOM)

PANEL CUT-OUTS

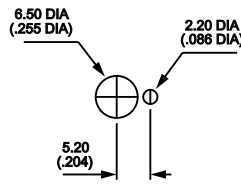

1/4" (6.35mm)
Standard (With locking ring)

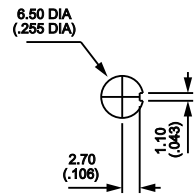

1/4" (6.35mm)
with K option

SPECIAL OPTIONS

- F** Tin plated terminals (for p.c. terminals only).
- X601** Silver plated brass contacts. Contact ratings: 0.2A 250VAC, 0.4A 125VAC or 0.5A 30VDC. Electric life: 20,000 cycles min. Minimum quantity: 5,000 pieces.
- X718** Bushing 15/32" (11.9mm). For all basic models (solder lug, straight p.c. or right angle p.c. terminals). Available with actuators 13 & 6. Sealing option **K** available.
- X934** Flatted 15/32" (11.9mm) bushing and front panel sealing with 2 'o'-rings.

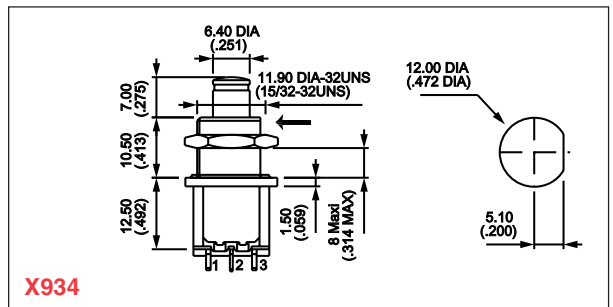

X934

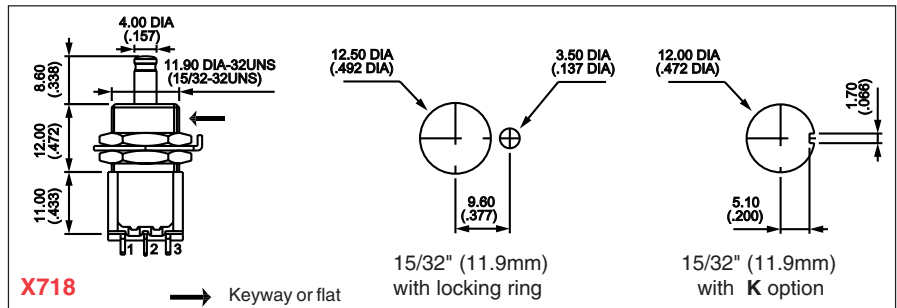

X718

→ Keyway or flat

15/32" (11.9mm)
with locking ring

15/32" (11.9mm)
with K option

SEALING OPTIONS

- (NONE)** No sealing.
- B** Epoxy sealed terminals.
- K** Front panel sealing with 'o'-ring and gasket. Protects against water and dust. Withstands 1 bar pressure when switch is operated.
- KB** Combined sealings (above).

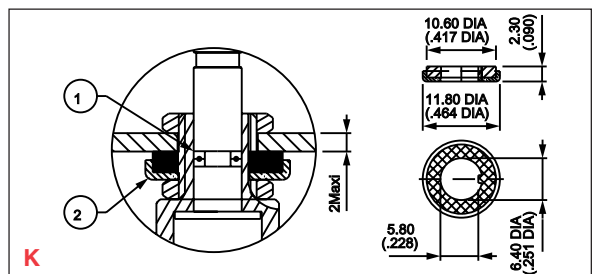

K

SPECIFICATIONS SUBJECT TO CHANGE WITHOUT NOTICE

C

8000 SERIES - MINI. MOMENTARY OR ALTERNATE ACTION PUSHBUTTON SWITCHES

CAPS

Note: replace last '0' in p/n with color code.

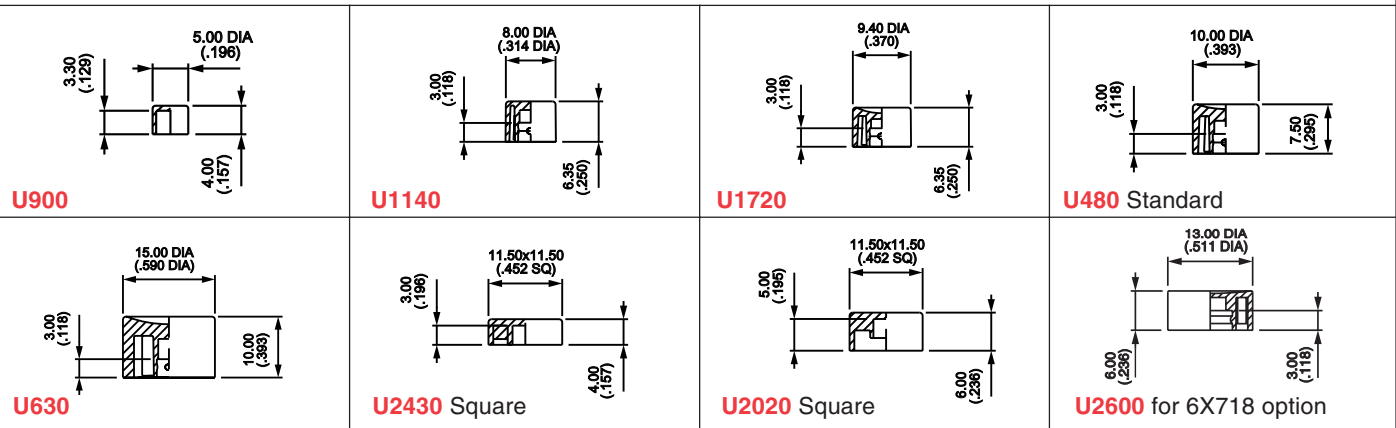

Cap colors

- | | |
|-----|--------|
| 1 | blue |
| 2 | black |
| 3 | green |
| 4 | grey |
| 5 | yellow |
| 6 | red |
| 7/1 | white |
| 9 | orange |

DRESS NUTS (chrome plated)

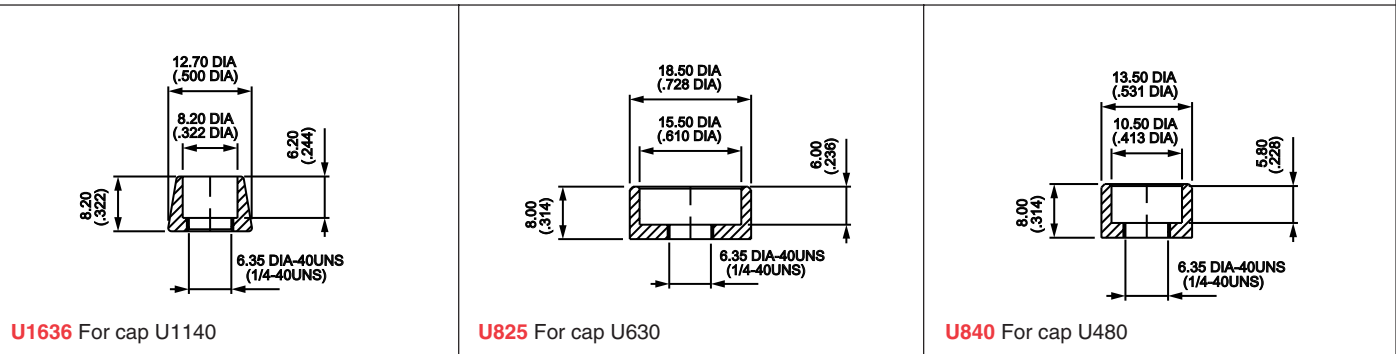

SPECIFICATIONS SUBJECT TO CHANGE WITHOUT NOTICE

800 SERIES - SNAP-ACTING MINIATURE PUSHBUTTON SWITCHES

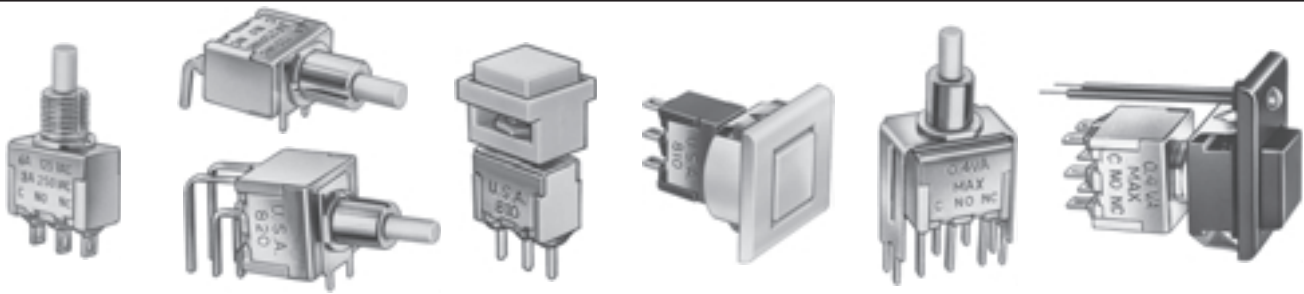

FEATURES

- Dry circuit through power ratings .
- Ultra-rugged construction SPDT & DPDT momentary models with numerous options.
- Panel, panel & p.c. and p.c. mounting models, lighted and unlighted.

SPECIFICATIONS

Contact ratings (resistive loads):	(Q) power models - coin silver: 6 Amps at 125 VAC, 3 Amps at 250 VAC or 7 Amps at 30 VDC. (B) dry circuit models - gold over nickel over brass: 0.4 VA max. at 20 V max. UL models - coin silver: 6 Amps at 125 VAC or 3 Amps at 250 VAC (75% power factor). UL file no. E66367. CSA models - coin silver: same ratings as UL models. CSA file no. LR54592-1.
Initial contact resistance:	20 milliohms max. at 3 VDC, 0.1 Amp.
Insulation resistance:	Greater than 200,000 megohms between terminals & case ground.
Dielectric strength:	Greater than 1500 VAC for 1 minute between terminals & case ground.
Electrical life (resistive loads):	60,000 cycles min. at full load.
Operating temperature range:	-30°C to +85°C
Total travel:	.035" (0.9mm) approx.
Actuation force:	Single pole: 290 ± 75 grams Double pole: 550 ± 75 grams

Also see economy ratings N & T in options section.

MATERIALS

Contacts:	Coin silver for power, UL & CSA models. Gold over nickel over brass for dry circuit models.
Actuator:	Glass filled polyester, color white
Bushing:	Nickel plated brass
Strap:	Stainless steel
Case:	Melamine phenolic, color red
Terminal seal:	Epoxy (standard)
Support bracket:	Brass or steel, tin plated
Spring mounting bracket:	Stainless steel
Bezel & cap:	Nylon. Available in black, red & white. Consult factory for other colors.
Hardware:	See 'Miscellaneous' section.
LED:	Intensity: 2.0 mcd at 10 mA. Forward voltage: 2.0V (3.0V max.). Max. continuous forward current: 15 mA for red, 30 mA for green & 20 mA for yellow. Red is standard. Yellow & green are optional. Specifications are subject to change without notice - consult factory.

AGENCY RECOGNITION UL, & CSA. Marking: Switches ordered with '/UL' added at end of model no. are supplied with recognition marked. Switches ordered with '/CSA' added at end of model no. are supplied with recognition marked.



ABOUT THIS SERIES

The material in this series is organized in the following sequence:

- Completely specified switch models
- 'build your own switch' order format
- Miscellaneous
- Option drawings & information
- Panel cut-outs

800 SERIES - SNAP-ACTING MINIATURE PUSHBUTTON SWITCHES

Solder lug terminals - panel mounting

SINGLE POLE

POWER CKT. MODEL NO.	UL MODEL NO.
810KMZQ	810KMZQ/UL

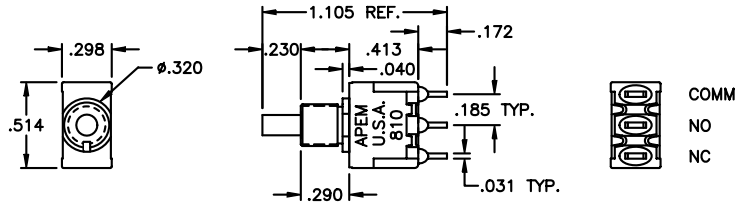

DOUBLE POLE

POWER CKT. MODEL NO.	UL MODEL NO.
820KMZQ	820KMZQ/UL

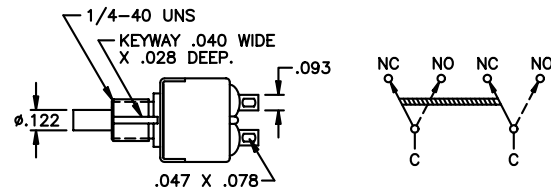
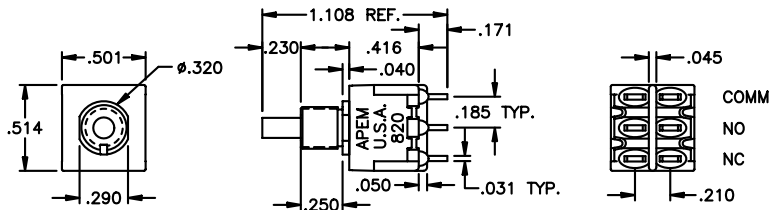

Horizontal right angle p.c. terminals - p.c. mounting

SINGLE POLE

DRY CKT. MODEL NO.	UL MODEL NO.
810KSAB	810KSAQ/UL
810KSA-1B	810KSA-1Q/UL

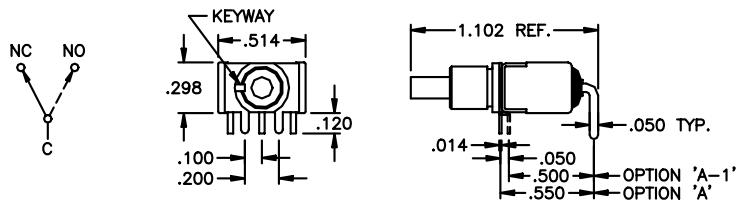
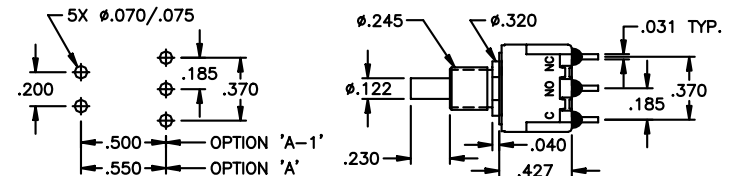
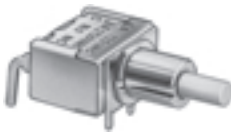

DOUBLE POLE

DRY CKT. MODEL NO.	UL MODEL NO.
820KSAB	820KSAQ/UL
820KSA-1B	820KSA-1Q/UL

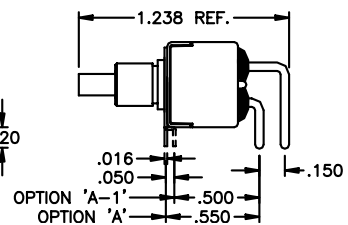
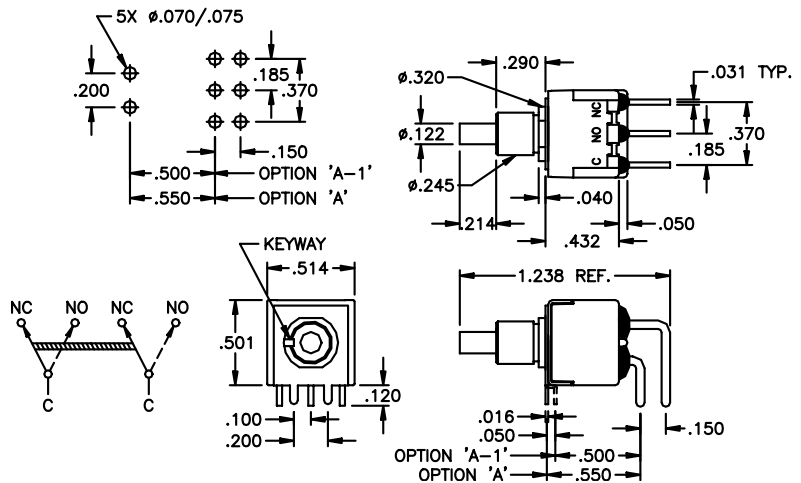

SPECIFICATIONS SUBJECT TO CHANGE WITHOUT NOTICE

800 SERIES - SNAP-ACTING MINIATURE PUSHBUTTON SWITCHES

Vertical right angle p.c. terminals - p.c. mounting

SINGLE POLE

DRY CKT. MODEL NO.	UL MODEL NO.
810KSVB	810KSVQ/UL
810KSV-1B	810KSV-1Q/UL
810KSV-2B	810KSV-2Q/UL

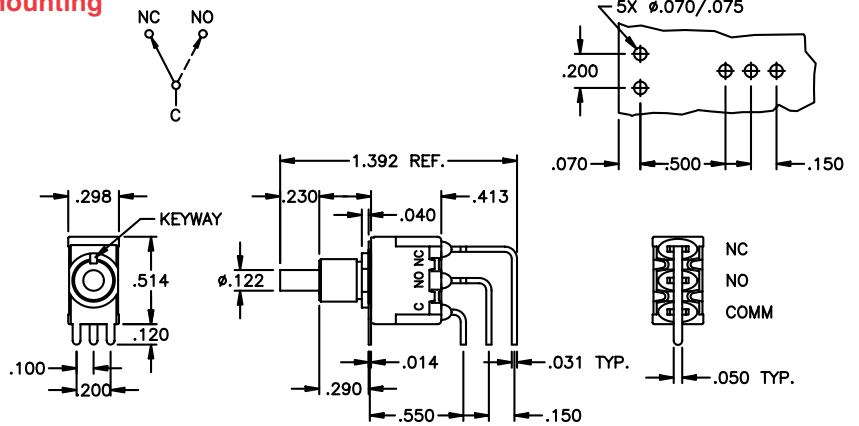

DOUBLE POLE

DRY CKT. MODEL NO.	UL MODEL NO.
820KSVB	820KSVQ/UL
820KSV-1B	820KSV-1Q/UL
820KSV-2B	820KSV-2 Q/UL

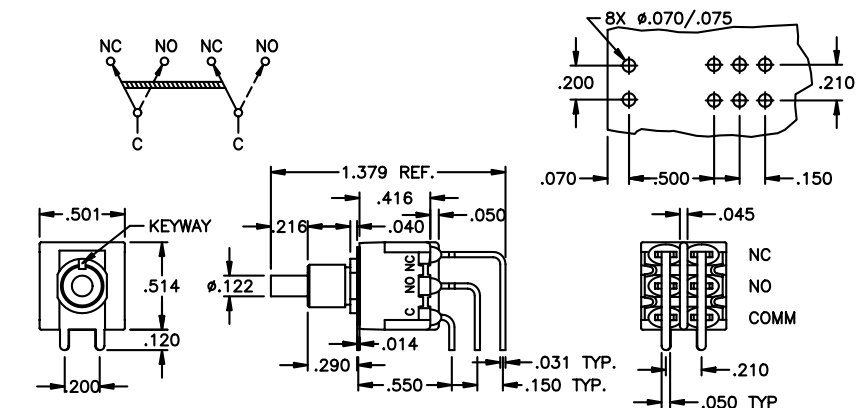

Straight p.c. terminals with bracket

SINGLE POLE

DRY CKT. MODEL NO.	UL MODEL NO.
810KSV30B	810KSV30Q/UL
810KSV40B	810KSV40Q/UL

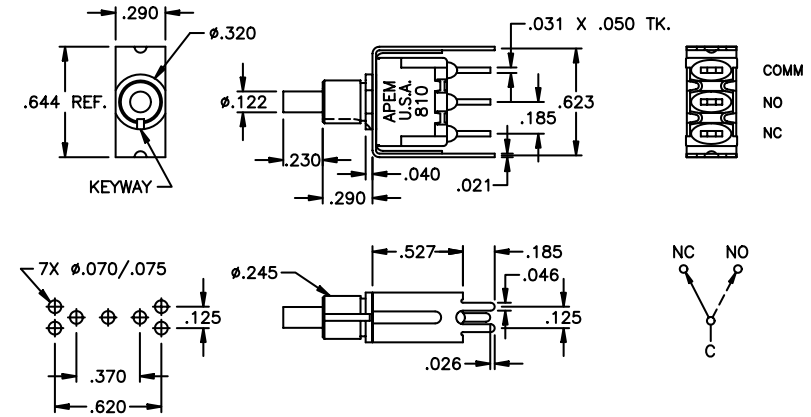

DOUBLE POLE

DRY CKT. MODEL NO.	UL MODEL NO.
820KSV30B	820KSV30Q/UL
820KSV40B	820KSV40Q/UL

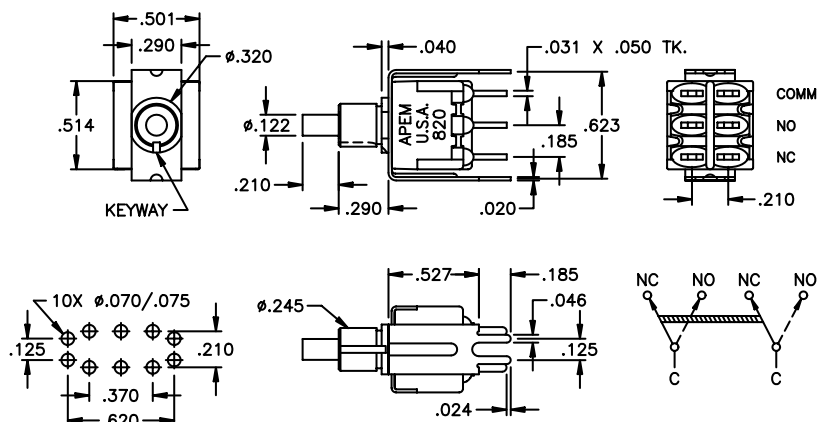

SPECIFICATIONS SUBJECT TO CHANGE WITHOUT NOTICE

C

800 SERIES - SNAP-ACTING MINIATURE PUSHBUTTON SWITCHES

Solder lug terminals - snap-in bezel with outboard LED

SINGLE POLE

POWER CKT. MODEL NO.	UL MODEL NO.	DIM. A
810K2M1ZQJ6122	810K2M1ZQJ6122/UL	.100
810K1M1ZQJ6122	810K1M1ZQJ6122/UL	.010

Models listed above have black bezel and cap.

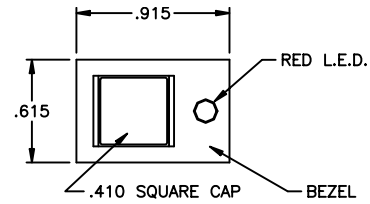
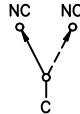

DOUBLE POLE

POWER CKT. MODEL NO.	UL MODEL NO.	DIM. A
820K2M1ZQJ6122	820K2M1ZQJ6122/UL	.100
820K1M1ZQJ6122	820K1M1ZQJ6122/UL	.010

Models listed above have black bezel and cap.

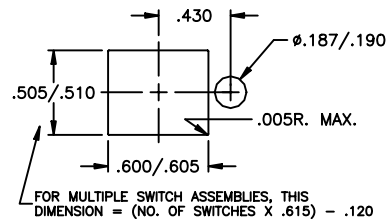
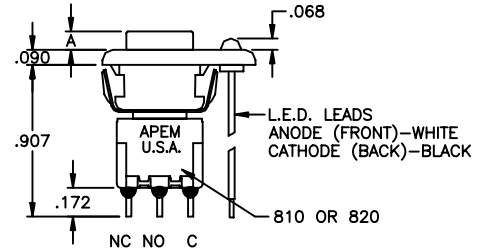
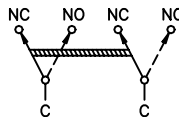
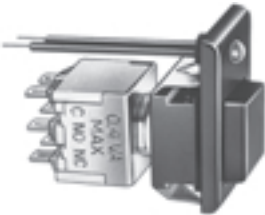

Solder lug terminals - snap-in bezel

SINGLE POLE

POWER CKT. MODEL NO.	UL MODEL NO.	DIM. A
810K2M1ZQJ8122	810K2M1ZQJ8122/UL	.100
810K1M1ZQJ8122	810K1M1ZQJ8122/UL	.010

Models listed above have black bezel and cap.

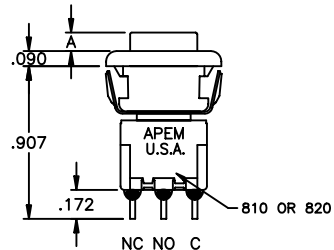
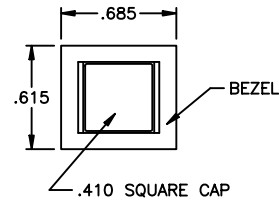
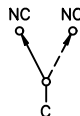

DOUBLE POLE

POWER CKT. MODEL NO.	UL MODEL NO.	DIM. A
820K2M1ZQJ8122	820K2M1ZQJ8122/UL	.100
820K1M1ZQJ8122	820K1M1ZQJ8122/UL	.010

Models listed above have black bezel and cap.

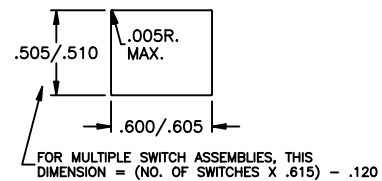
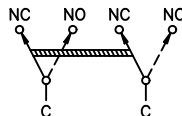

SPECIFICATIONS SUBJECT TO CHANGE WITHOUT NOTICE

C

800 SERIES - SNAP-ACTING MINIATURE PUSHBUTTON SWITCHES

Straight p.c. terminals - p.c. mounting bezel

SINGLE POLE

DRY CKT. MODEL NO.	UL MODEL NO.	DIM. A
810K2M1CBJ8422	810K2M1CQJ8422/UL	.100
810K1M1CBJ8422	810K1M1CQJ8422/UL	.010

DOUBLE POLE

DRY CKT. MODEL NO.	UL MODEL NO.	DIM. A
820K2M1CBJ8422	820K2M1CQJ8422/UL	.100
820K1M1CBJ8422	820K1M1CQJ8422/UL	.010

Models listed above have black bezel and cap.

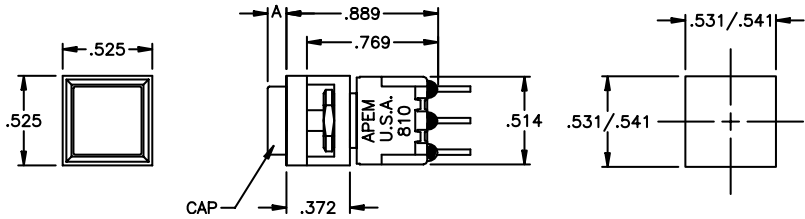
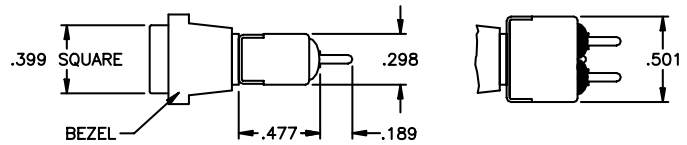
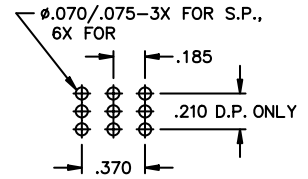
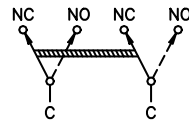
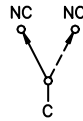

Straight p.c. terminals w/bracket - p.c. mounting bezel

SINGLE POLE

DRY CKT. MODEL NO.	UL MODEL NO.	DIM. A
810K2M1V30BJ8422	810K2M1V30QJ8422/UL	.100
810K1M1V30BJ8422	810K1M1V30QJ8422/UL	.010

DOUBLE POLE

DRY CKT. MODEL NO.	UL MODEL NO.	DIM. A
820K2M1V30BJ8422	820K2M1V30QJ8422/UL	.100
820K1M1V30BJ8422	820K1M1V30QJ8422/UL	.010

Models listed above have black bezel and cap.

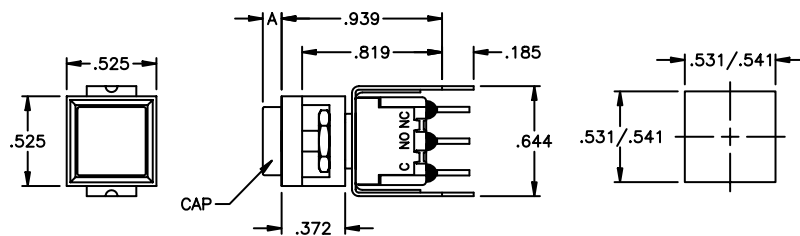
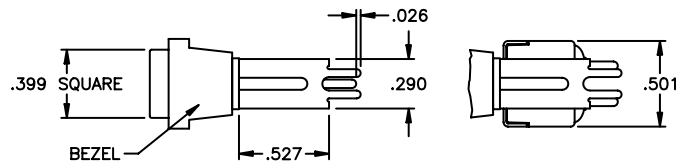
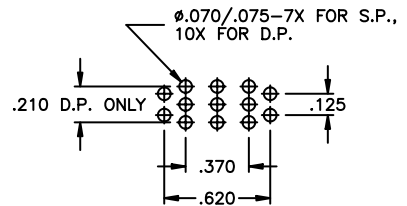
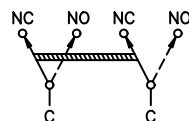

800 SERIES - SNAP-ACTING MINIATURE PUSHBUTTON SWITCHES

Horizontal right angle p.c. terminals - p.c. mounting bezel

SINGLE POLE

DRY CKT. MODEL NO.	UL MODEL NO.	DIM. A
810K2M1ABJ8422	810K2M1AQJ8422/UL	.100
810K1M1ABJ8422	810K1M1AQJ8422/UL	.010

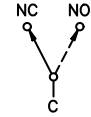
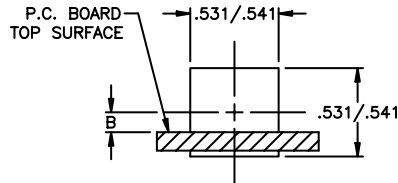

DOUBLE POLE

DRY CKT. MODEL NO.	UL MODEL NO.	DIM. A
820K2M1ABJ8422	820K2M1AQJ8422/UL	.100
820K1M1ABJ8422	820K1M1AQJ8422/UL	.010

Models listed above have black bezel and cap.

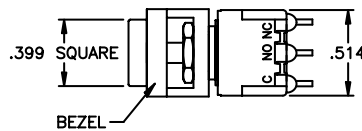
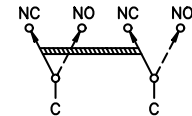
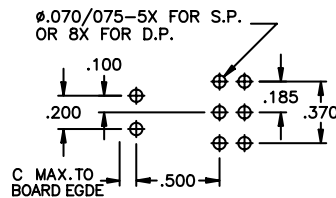

Poles	Option	Dim. B	Dim. C
SP	A	.148	.045 max.
SP	A-1	.164	.095 max.
DP	A	.250	.300 max.
DP	A-1	.266	.350 max.

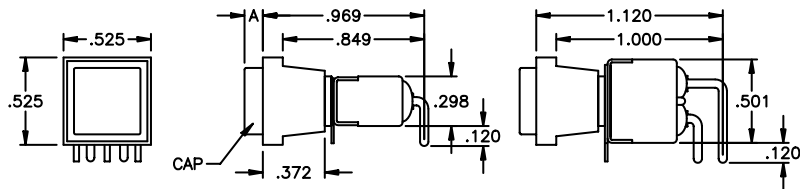

Vertical right angle p.c. terminals - p.c. mounting bezel

SINGLE POLE

DRY CKT. MODEL NO.	UL MODEL NO.	DIM. A
810K2M1V-1BJ8422	810K2M1V-1QJ8422/UL	.100
810K1M1V-1BJ8422	810K1M1V-1QJ8422/UL	.010

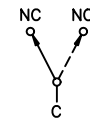
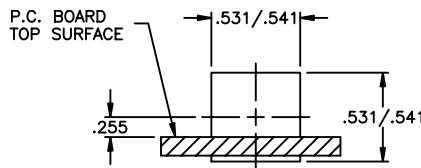

DOUBLE POLE

DRY CKT. MODEL NO.	UL MODEL NO.	DIM. A
820K2M1V-1BJ8422	820K2M1V-1QJ8422/UL	.100
820K1M1V-1BJ8422	820K1M1V-1QJ8422/UL	.010

Models listed above have black bezel and cap.

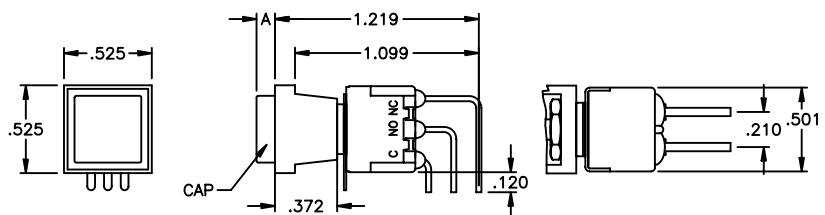
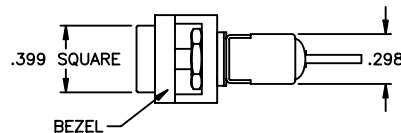
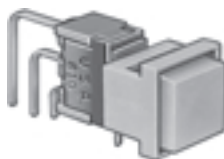
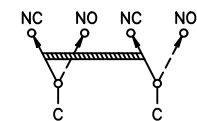
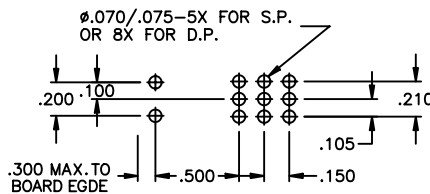

SPECIFICATIONS SUBJECT TO CHANGE WITHOUT NOTICE

800 SERIES - SNAP-ACTING MINIATURE PUSHBUTTON SWITCHES

Snap-in bezel for round hole mounting

Self-keying against rotation

SINGLE POLE

POWER CKT. MODEL NO.	UL MODEL NO.	DIM. A
810K2M1ZQJ9622	810K2M1ZQJ9622/UL	.100
810K1M1ZQJ9622	810K1M1ZQJ9622/UL	.010

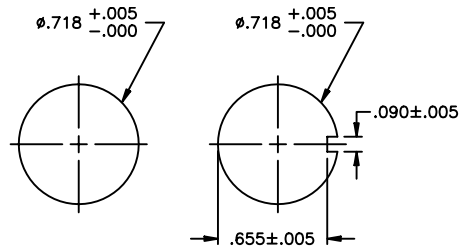

DOUBLE POLE

POWER CKT. MODEL NO.	UL MODEL NO.	DIM. A
820K2M1ZQJ9622	820K2M1ZQJ9622/UL	.100
820K1M1ZQJ9622	820K1M1ZQJ9622/UL	.010

Models listed above have black bezel and cap.

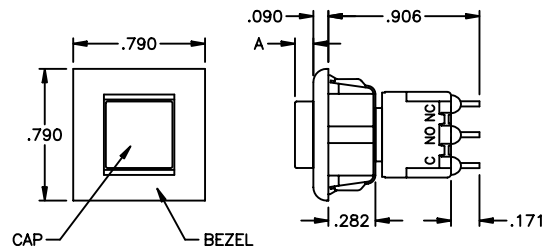
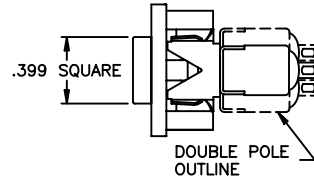

SPECIFICATIONS SUBJECT TO CHANGE WITHOUT NOTICE

C

Additional ordering information: Commonly ordered models are shown above and on prior pages with complete model numbers and specifications. Below is an order format that enables you to 'build your own switch' and specify the correct switch model number by simply selecting from all available options shown and filling in the boxes.

'BUILD YOUR OWN SWITCH' ORDER FORMAT

Fill in boxes with selections shown for **Model Structure**, then add **Options** selections for complete model number. Allowable options are shown below each respective box with brief description - see option dwgs. & info. following.

Note: 'NONE' indicates box may be left empty.

Model Structure:

Series	Actuators	Bushings	Terminations	Contact materials
<input type="text"/>	<input type="text"/>	<input type="text"/>	<input type="text"/>	<input type="text"/>
Single pole: 8 1 0	K Standard K 1 Short	M Standard 1/4" thd'd. M 1 Short 1/4" thd'd.	Z Solder lug C Printed circuit W Wirewrap W 1 Lg. wirewrap W 3 Sht. wirewrap X Extra lg. wirewrap	B Gold Q Coin silver G Gold over coin silver N Economy gold T Economy silver
Double pole: 8 2 0	K 2 Medium	D 1/4" thd'd. w/'D' flat S Non-threaded	Horiz. right angle p.c. terminals: A A - 1 Vertical right angle p.c. terminals: V V - 1 V - 2	

Notes:

When bezel is specified and flush cap is desired, specify K1 actuator and M1 bushing.
When bezel is specified and raised cap is desired, specify K2 actuator and M1 bushing.
Epoxy terminal seal is standard on 800 Series.

Options:

Bezel& cap	Bezel color	Cap color	Approvals
<input type="text"/>	<input type="text"/>	<input type="text"/>	<input type="text"/>
(NONE) J 6 1 Snap-in w/LED J 8 1 Snap-in no LED J 8 4 P.C. style J 9 6 Snap-in (round hole)	(NONE) 2 Black 6 Red 8 White Consult factory for other colors.	(NONE) 2 Black 6 Red 8 White	(NONE) / U L / C S A

Although most combinations of options are available, some may result in incompatibilities. Consult factory if there is any question.

Straight p.c. terminals w/brkt.:
V 3 0 or V 3 1
V 4 0 or V 4 1
V 7 0
V 8 0
V 7 1
V 8 1

Example of completely specified model number:
820K1M1ZQJ8126/UL/CSA

800 SERIES - SNAP-ACTING MINIATURE PUSHBUTTON SWITCHES

MISCELLANEOUS

**TYPICAL
SWITCH
CROSS
SECTION**

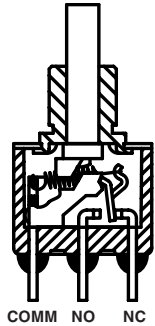

HARDWARE SUPPLIED

(See Hardware section of catalog)

Switches with M option bushings are supplied with (2) A112 Hex Nuts, (1) A115 Lockwasher and (1) A107 Anti-rotate Ring.

Switches with D option bushings are supplied with (2) A112 Hex Nuts and (1) A115 Lockwasher.

Switches with M1 option bushings are supplied with (1) A112 Hex Nut and (1) A115 Lockwasher.

Note: Switches with non-threaded bushings or bezels supplied without hardware.

**SWITCH BODY
SIZES WITH
TERMINAL
LOCATION
DIMENSIONS**

SIDE VIEW
SINGLE POLE

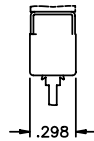

SIDE VIEW
DOUBLE POLE

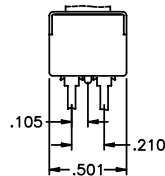

FRONT VIEW
SINGLE AND
DOUBLE POLE

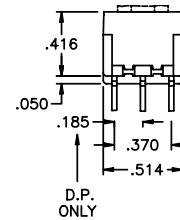

BUSHING OPTIONS

**NOTE:
BUSHING M AND
ACTUATOR K
ARE STANDARD.**

M & M1

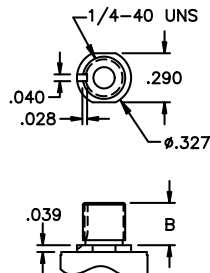

THREADED

D

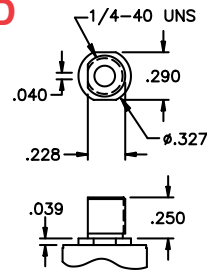

THREADED

S

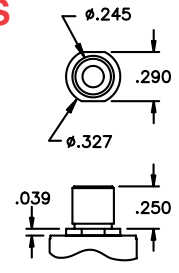

NON-THREADED

ACTUATOR/BUSHING OPTIONS

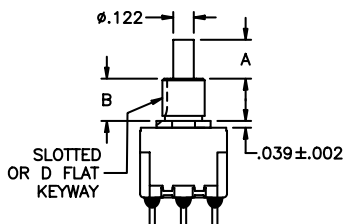

BUSHING OPTION	DIM. B	DIMENSION A ACTUATOR OPTION		
		K	K1	K2
M or D	.250	.230	.069	.168
S	.250	.230	.069	.168
M1	.154	.322	.165	.264

All bushings have 1/4-40 UNS-2A thread except S which is non-threaded.

Switch caps for switches without bezels also available - see Hardware section of catalog.

SPECIFICATIONS SUBJECT TO CHANGE WITHOUT NOTICE

800 SERIES - SNAP-ACTING MINIATURE PUSHBUTTON SWITCHES

TERMINATION OPTIONS

A

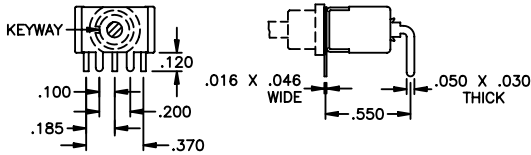

SINGLE POLE HORIZONTAL P.C. MOUNTING

A-1

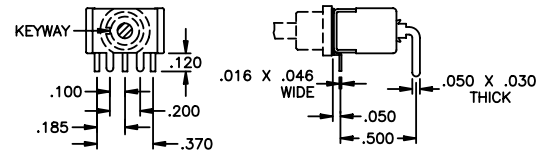

SINGLE POLE HORIZONTAL P.C. MOUNTING

A

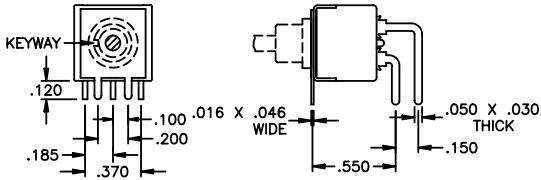

DOUBLE POLE HORIZONTAL P.C. MOUNTING

A-1

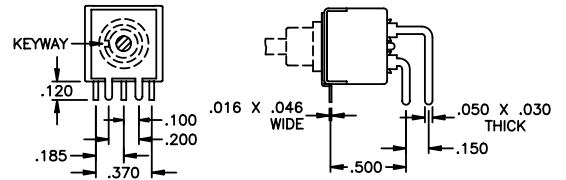

DOUBLE POLE HORIZONTAL P.C. MOUNTING

V, V-1 & V-2

Option	Dim. A	Dim. B
V	.550	.150
V-1	.500	.150
V-2	.500	.100

FRONT VIEW SINGLE POLE

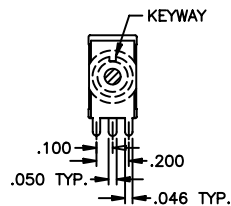

FRONT VIEW DOUBLE POLE

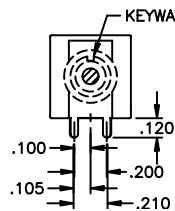

SIDE VIEW - SINGLE & DOUBLE POLE

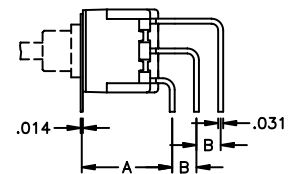

VERTICAL P.C. MOUNTING

V30, V40, V70, V80, V31, V41, V71 & V81

PANEL LAYOUT V30, V31, V40 & V41

Option	Dim. A	Dim. B
V30-V31	.527	.024
V40-V41	.647	.048

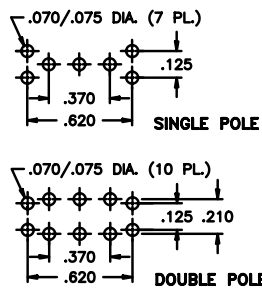

FRONT VIEW SINGLE POLE

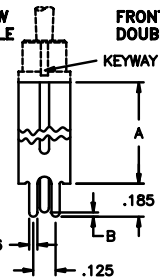

FRONT VIEW DOUBLE POLE

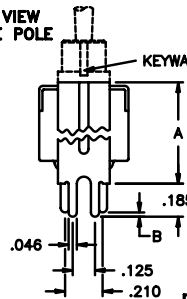

SIDE VIEW - SINGLE AND DOUBLE POLE

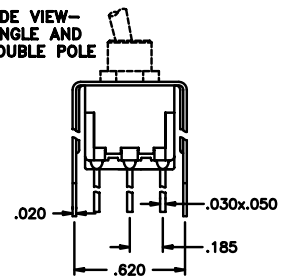

PRINTED CIRCUIT MOUNTING

PANEL LAYOUT V70, V71, V80 & V81

Option	Dim. A
V70-V71	.630
V80-V81	.953

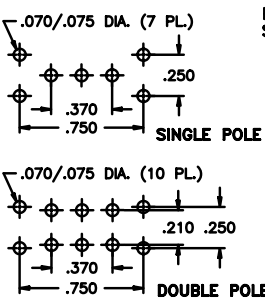

FRONT VIEW SINGLE POLE

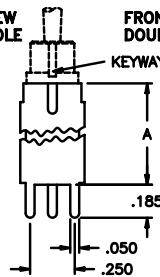

FRONT VIEW DOUBLE POLE

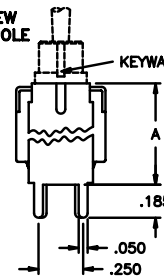

SIDE VIEW - SINGLE AND DOUBLE POLE

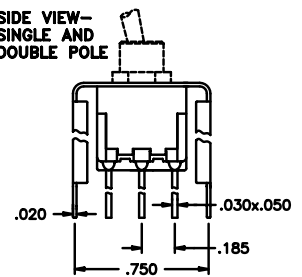

PRINTED CIRCUIT MOUNTING

V31, V41, V71 & V81 ARE THE SAME AS V30, V40, V70 & V80 RESPECTIVELY, EXCEPT WITH CRIMPED LEG DESIGN FOR P.C. BOARD RETENTION, AS SHOWN TO RIGHT.

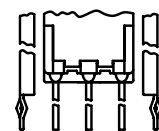
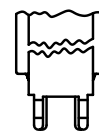

SPECIFICATIONS SUBJECT TO CHANGE WITHOUT NOTICE

C

800 SERIES - SNAP-ACTING MINIATURE PUSHBUTTON SWITCHES

TERMINATION OPTIONS (CONT'D.)

Z	C	W	W1	W3	X
<p>.172 .031 TYP. .047 X .078 TYP. .093</p>	<p>.062 .190 .050 .030 TK.</p>	<p>.062 .750 .050 .030 TK.</p>	<p>.062 .964 .050 .030 TK.</p>	<p>.062 .425 .050 .030 TK.</p>	<p>.062 1.062 .050 .030 TK.</p>
SOLDER LUG	PRINTED CIRCUIT	WIREWRAP	LONG WIREWRAP	SHORT WIREWRAP	EXTRA LG. WIREWRAP

CONTACT MATERIAL OPTIONS

B	Dry circuit - gold over nickel over brass. RATING: 0.4 Volt-Amps (VA) max. at 20 V max. ELECTRIC LIFE: 60,000 cycles minimum. MECHANICAL LIFE: 500,000 cycles minimum.	
Q	Power circuit - coin silver. RATING: 6 Amps at 125 VAC, 3 Amps at 250 VAC or 7 Amps at 30 VDC (resistive loads). ELECTRIC LIFE: 60,000 cycles minimum at full load.	
G	Dry circuit or power circuit - gold over nickel over coin silver. RATINGS & ELECTRIC LIFE: Same as B & Q above - i.e. - can be used in either dry circuit or power circuit, however once used in power circuit, switch cannot be re-used in dry circuit. This option satisfies those customers who have both dry circuit and power circuit requirements, but prefer to inventory only one switch for both.	
N	Dry circuit - gold over nickel over brass. Note- less gold than B option. RATING: 0.4 Volt-Amps (VA) max. at 20 V max. ELECTRIC LIFE: 10,000 cycles min. at 13 cycles per minute.	
T	Power circuit - Silver plate over brass. RATING: 1 Amp at 125 VAC or 0.5 Amps at 250 VAC (resistive loads). ELECTRIC LIFE: 10,000 cycles min. at 13 cycles per minute.	Solder dipped terminals and custom contact plating available - contact factory.

UL & CSA OPTIONS

UL	For power circuits - coin silver RATING: 6 Amps at 125 VAC or 3 Amps at 250 VAC (75% power factor). Underwriter Laboratories file no. E66367. Note - applicable only to terminations with coin silver contacts (Q or G options).
CSA	For power circuits - coin silver RATING: 6 Amps at 125 VAC or 3 Amps at 250 VAC (75% power factor). Canadian Standards Association file no. LR54592-1. Note - applicable only to terminations with coin silver contacts (Q or G options) as CSA recognizes switches for power applications only.

PANEL CUT-OUTS

Cut-outs that accept all 1/4-40 threaded bushings:

<p>$\phi .250 \pm .003$</p>	<p>.187±.005 $\phi .078 \pm .003$ $\phi .250 \pm .003$</p>	<p>.240±.010 $\phi .093 \pm .003$ $\phi .250 \pm .003$</p>	<p>.234 .230 $\phi .250 \pm .003$</p>	<p>.020 .023 .035 .030 $\phi .250 \pm .003$</p>	<p>$\phi .250 \pm .003$</p>
Without keying	With A107 anti-rotate ring	With A158 anti-rotate ring	With D bushing	With slotted keyway bushings	Accepts all 1/4" non-threaded bushings

SPECIFICATIONS SUBJECT TO CHANGE WITHOUT NOTICE

PB SERIES - MINIATURE MOMENTARY PUSHBUTTON SWITCHES

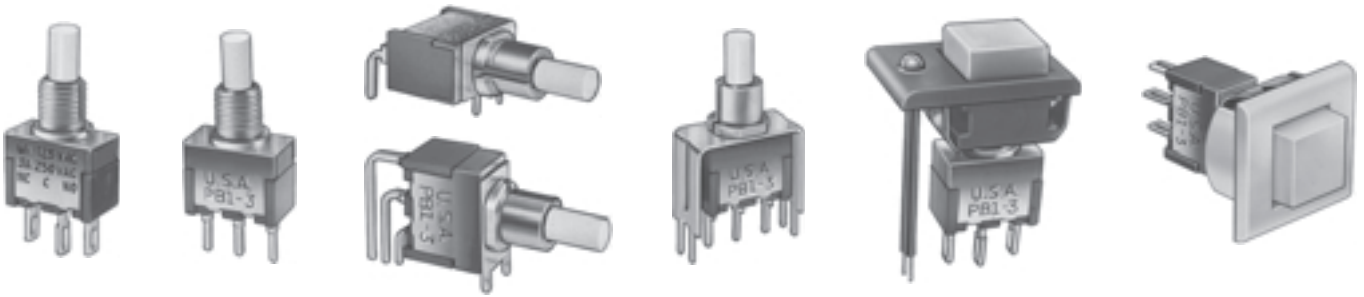

SPECIFICATIONS SUBJECT TO CHANGE WITHOUT NOTICE

C

FEATURES

- Dry circuit through power ratings .
- Rugged construction SPDT momentary models with numerous options.
- Panel, panel & p.c. and p.c. mounting models, lighted and unlighted.

SPECIFICATIONS

Contact ratings (resistive loads): (Q) power models - coin silver: 6 Amps at 125 VAC, 3 Amps at 250 VAC or 7 Amps at 30 VDC.
(B) dry circuit models - gold over nickel over brass: 0.4 VA max. at 20 V max.
UL models - coin silver: 6 Amps at 125 VAC or 3 Amps at 250 VAC (75% power factor). UL file no. E66367. CSA models - coin silver: same ratings as UL models. CSA file no. LR54592-1.

Initial contact resistance: 5 milliohms max. at 3 VDC, 0.1 Amp.

Insulation resistance: Greater than 200,000 megohms between terminals & case ground.

Dielectric strength: Greater than 2000 VAC for 1 minute between terminals & case ground.

Electrical life (resistive loads): 100,000 cycles min. at full load.

Operating temperature range: -30°C to +85°C

Total travel & operating force: .065" (1.6mm) & 19 oz. (approximate values).

MATERIALS

Contacts: Coin silver for power, UL & CSA models. Gold over nickel over brass for dry circuit models.

Actuator: Glass filled polyester, color white

Bushing: Nickel plated brass

Strap: Stainless steel

Case: Melamine phenolic, color red

Terminal seal: Epoxy (optional)

Support bracket: Brass or steel, tin plated

Spring mounting bracket: Stainless steel

Bezel & cap: Nylon. Available in black, red or white. Consult factory for other colors.

Hardware: See 'Miscellaneous' section.

LED: Intensity: 2.0 mcd at 10 mA. Forward voltage: 2.0V (3.0V max.). Max. continuous forward current: 15 mA for red, 30 mA for green & 20 mA for yellow. Red is standard. Yellow & green are optional. Specifications are subject to change without notice - consult factory.

AGENCY RECOGNITION



UL, & CSA. Marking: Switches ordered with '/UL' added at end of model no. are supplied with recognition marked. Switches ordered with '/CSA' added at end of model no. are supplied with recognition marked.

ABOUT THIS SERIES

The material in this series is organized in the following sequence:
a. Completely specified switch models b. 'build your own switch' order format c. Miscellaneous
d. Option drawings & information e. Panel cut-outs & miscellaneous

PB SERIES - MINIATURE MOMENTARY PUSHBUTTON SWITCHES

Solder lug terminals - panel mounting



POWER CKT. MODEL NO.	DRY CKT. MODEL NO.
PB1-3P2Y1ZQ	PB1-3P2Y1ZB

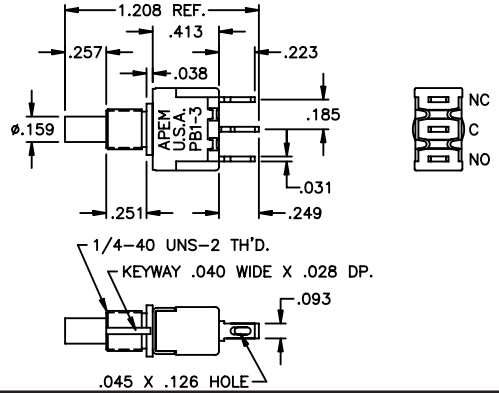
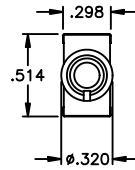
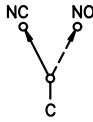

C

P.C. or wirewrap terminals - panel or p.c. mounting



POWER CKT. MODEL NO.	DRY CKT. MODEL NO.
PB1-3P2Y1CQ	PB1-3P2Y1CB

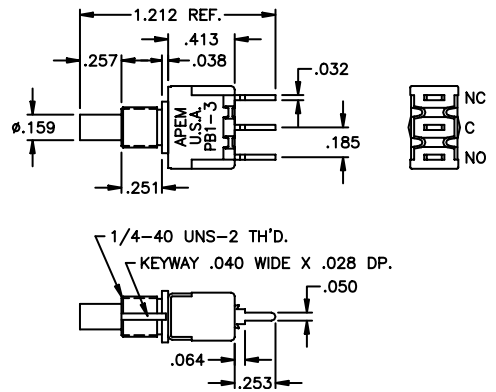
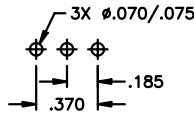
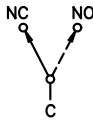

Horizontal right angle p.c. terminals - p.c. mounting



POWER CKT. MODEL NO.	DRY CKT. MODEL NO.
PB1-3P2Y2A-1Q	PB1-3P2Y2A-1B

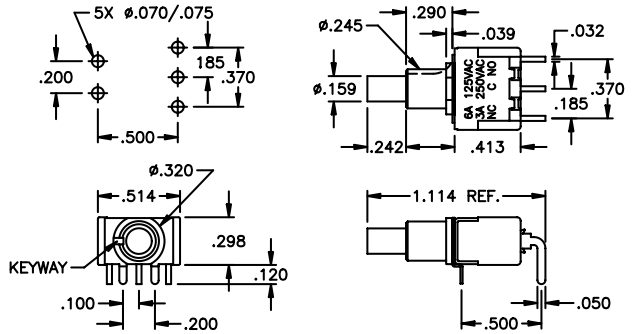
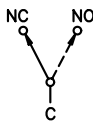

Vertical right angle p.c. terminals - p.c. mounting

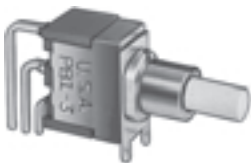

POWER CKT. MODEL NO.	DRY CKT. MODEL NO.
PB1-3P2Y2V-1Q	PB1-3P2Y2V-1B

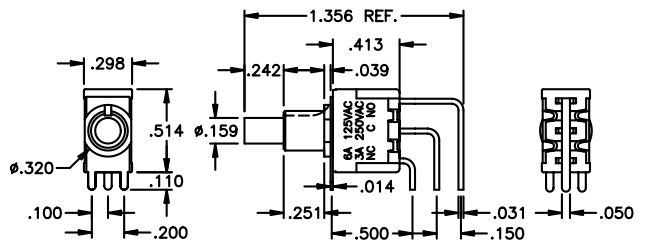
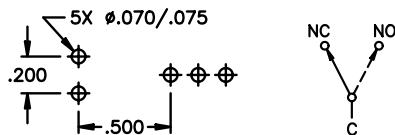

SPECIFICATIONS SUBJECT TO CHANGE WITHOUT NOTICE

PB SERIES - MINIATURE MOMENTARY PUSHBUTTON SWITCHES

Straight p.c. terminals with bracket - p.c. mounting



POWER CKT. MODEL NO.	DRY CKT. MODEL NO.
PB1-3P2Y2V30Q	PB1-3P2Y2V30B

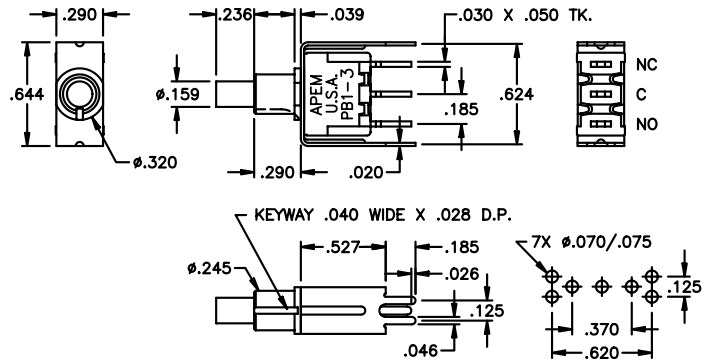
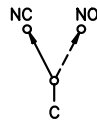

Solder lug terminals - snap-in bezel with LED



POWER CKT. MODEL NO.	DRY CKT. MODEL NO.
PB1-3P2Y1ZQJ6168	PB1-3P2Y1ZBJ6168

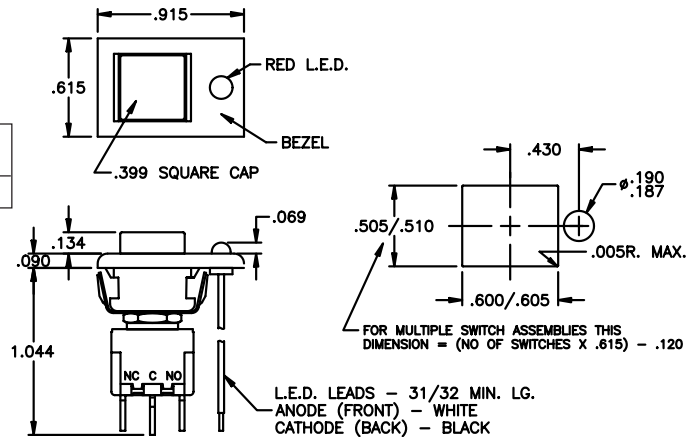
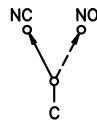

Solder lug terminals - snap-in bezel



POWER CKT. MODEL NO.	DRY CKT. MODEL NO.
PB1-3P2Y1ZQJ8182	PB1-3P2Y1ZBJ8182

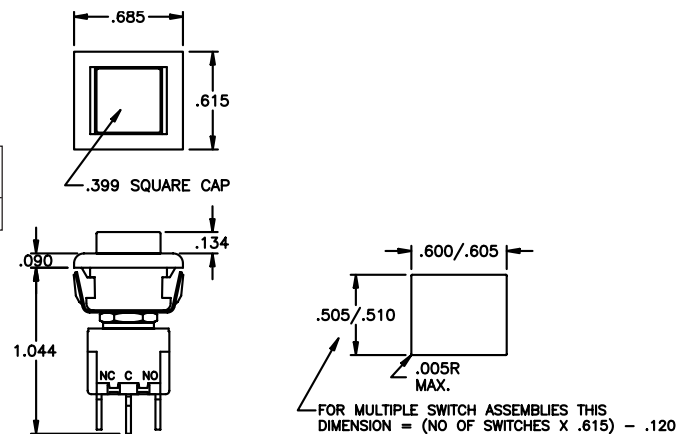
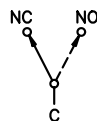

SPECIFICATIONS SUBJECT TO CHANGE WITHOUT NOTICE

C

PB SERIES - MINIATURE MOMENTARY PUSHBUTTON SWITCHES

C

Straight p.c. terminals - p.c. mounting bezel

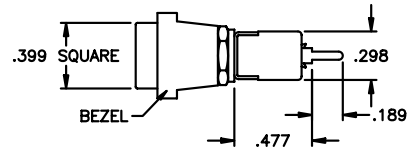
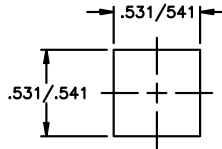
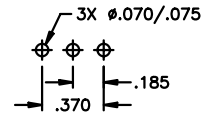
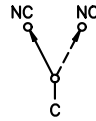

POWER CKT. MODEL NO.	DRY CKT. MODEL NO.
PB1-3P2Y1CQJ8488	PB1-3P2Y1CBJ8488

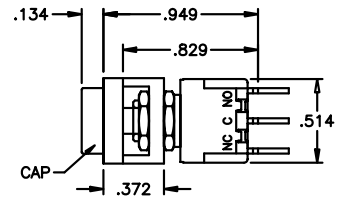
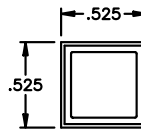

Straight p.c. terminals with bracket - p.c. mounting bezel

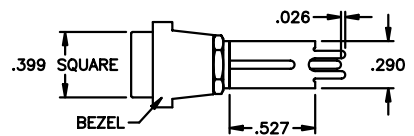
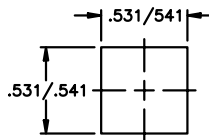
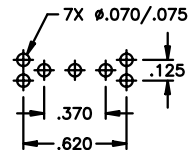
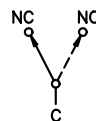

POWER CKT. MODEL NO.	DRY CKT. MODEL NO.
PB1-3P2Y1V30QJ8488	PB1-3P2Y1V30BJ8488

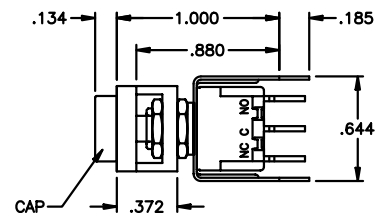
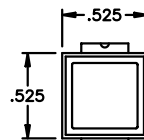

SPECIFICATIONS SUBJECT TO CHANGE WITHOUT NOTICE

PB SERIES - MINIATURE MOMENTARY PUSHBUTTON SWITCHES

Horizontal right angle p.c. terminals - p.c. mounting bezel

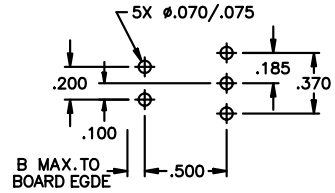
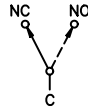

POWER CKT. MODEL NO.	DRY CKT. MODEL NO.
PB1-3P2Y1A-1QJ8488	PB1-3P2Y1A-1BJ8488

Option	Dim. A	Dim. B
A	.148	.045 max.
A-1	.164	.095 max.

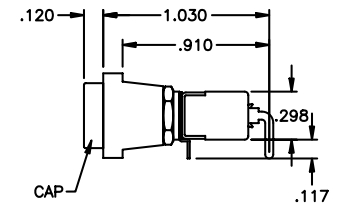
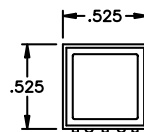
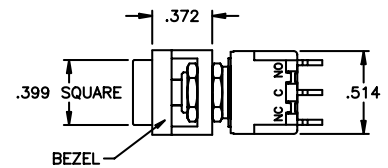
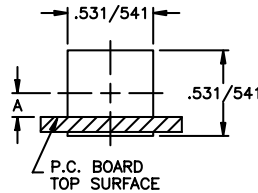

Vertical right angle p.c. terminals - p.c. mounting bezel

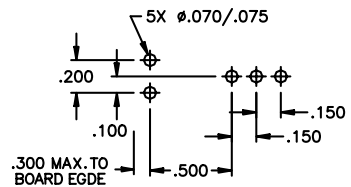
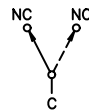
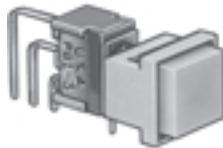

POWER CKT. MODEL NO.	DRY CKT. MODEL NO.
PB1-3P2Y1V-1QJ8488	PB1-3P2Y1V-1BJ8488

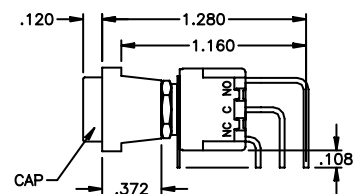
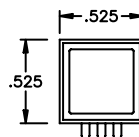
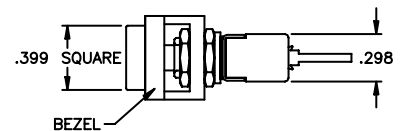
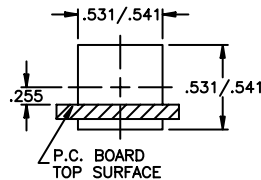

SPECIFICATIONS SUBJECT TO CHANGE WITHOUT NOTICE

C

PB SERIES - MINIATURE MOMENTARY PUSHBUTTON SWITCHES

Solder lug terminals - snap-in bezel for round hole mounting
Self-keying against rotation

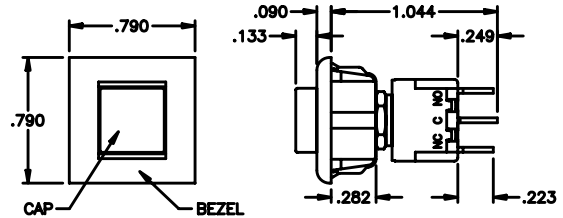
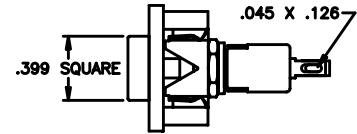
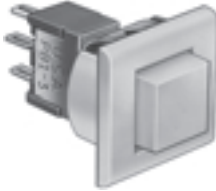

POWER CKT. MODEL NO.	DRY CKT. MODEL NO.
PB1-3P2Y1ZQJ9688	PB1-3P2Y1ZBJ9688

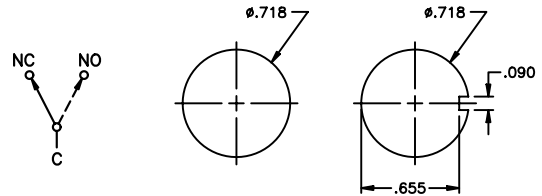

SPECIFICATIONS SUBJECT TO CHANGE WITHOUT NOTICE

Additional ordering information: Commonly ordered models are shown above and on prior pages with complete model numbers and specifications. Below is an order format that enables you to 'build your own switch' and specify the correct switch model number by simply selecting from all available options shown and filling in the boxes.

'BUILD YOUR OWN SWITCH' ORDER FORMAT

Fill in boxes with selections shown for **Model Structure**, then add **Options** selections for complete model number. Allowable options are shown below each respective box with brief description - see option dwgs. & info. following. Note: 'NONE' indicates box may be left empty.

Model Structure:

Series	Actuators	Bushings	Terminations	Contact materials
<input type="text" value="P"/> <input type="text" value="B"/> <input type="text" value="1"/> - <input type="text" value="3"/>	<input type="text" value=""/> <input type="text" value=""/>	<input type="text" value=""/> <input type="text" value=""/>	<input type="text" value=""/> <input type="text" value=""/> <input type="text" value=""/>	<input type="text" value=""/>
Note: When bezel is specified, specify P2 actuator and Y1 bushing.	P Long P 2 Short (standard)	Y 1/4" thd'd. Y 1 Short 1/4" thd'd. (standard) D 1/4" thd'd. w/'D' flat Y 2 Non-threaded	Z Solder lug C Printed circuit W Wirewrap W 1 Lg. wirewrap W 3 Sht. wirewrap X Extra lg. wirewrap Horiz. right angle p.c. terminals: A A - 1 Vertical right angle p.c. terminals: V V - 1 V - 2 Straight p.c. terminals w/brkt.: V 3 0 or V 4 1 V 4 0 or V 4 1 V 7 0 V 8 0 V 7 1 V 8 1	B Gold Q Coin silver G Gold over coin silver N Economy gold T Economy silver

Options:

Bezel & cap	Bezel color	cap color	Approvals
<input type="text" value=""/> <input type="text" value=""/> <input type="text" value=""/>	<input type="text" value=""/>	<input type="text" value=""/>	<input type="text" value=""/> <input type="text" value=""/> <input type="text" value=""/> <input type="text" value=""/>
(NONE) J 6 1 Snap-in w/LED J 8 1 Snap-in no LED J 8 4 P.C. style J 9 6 Snap-in (round hole)	(NONE) 2 Black 6 Red 8 White Consult factory for other colors.	(NONE) 2 Black 6 Red 8 White	(NONE) / U L / C S A

Although most combinations of options are available, some may result in incompatibilities. Consult factory if there is any question.

Example of completely specified model number:
PB1-3P2Y1ZQJ9622/UL/CSA

PB SERIES - MINIATURE MOMENTARY PUSHBUTTON SWITCHES

MISCELLANEOUS

HARDWARE SUPPLIED

(See Hardware section of catalog)

Switches with Y option bushings are supplied with (2) A112 Hex Nuts, (1) A115 Lockwasher and (1) A107 Anti-rotate Ring.

Switches with D option bushings are supplied with (2) A112 Hex Nuts and (1) A115 Lockwasher.

Switches with Y1 option bushings are supplied with (1) A112 Hex Nut and (1) A115 Lockwasher.

Note: Switches with non-threaded bushings or bezels supplied without hardware.

**TYPICAL
SWITCH
CROSS
SECTION**

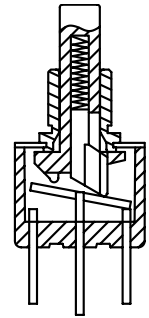

ACTUATOR/BUSHING OPTIONS

Drawings reflect allowable actuator/bushing combinations.

Note for drawings P2Y1 & P2Y2:
Asterisk indicates .290 flats are supplied with options A, V, V30, V40, V70, V71, V80 & V81.
For other options, .320 Dia. with no flats may be supplied

PY

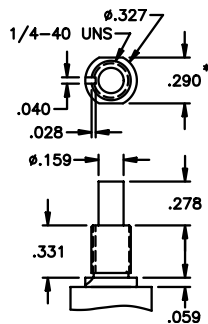

THREADED

P2Y1

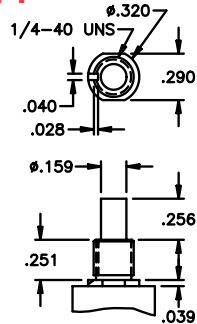

THREADED

P2Y2

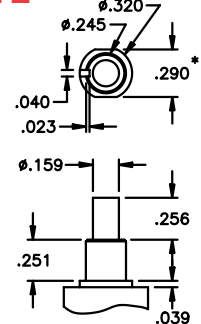

NON-THREADED

PD

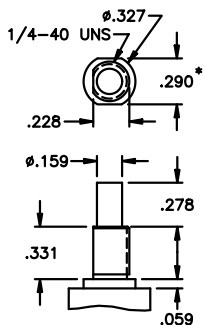

THREADED

TERMINATION OPTIONS

A

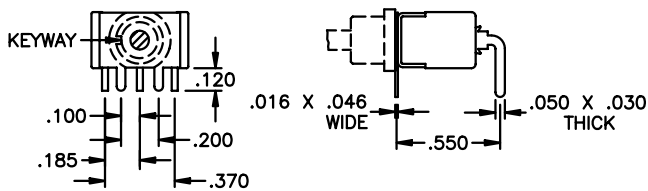

HORIZONTAL P.C. MOUNTING

A-1

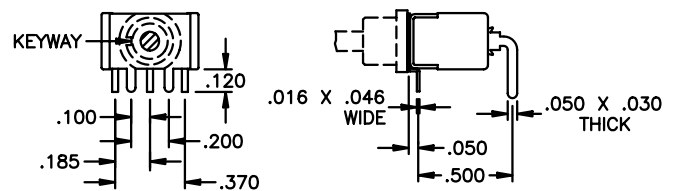

HORIZONTAL P.C. MOUNTING

SPECIFICATIONS SUBJECT TO CHANGE WITHOUT NOTICE

C

PB SERIES - MINIATURE MOMENTARY PUSHBUTTON SWITCHES

TERMINATION OPTIONS (CONT'D.)

V, V-1 & V-2

Option	Dim. A	Dim. B
V	.550	.150
V-1	.500	.150
V-2	.500	.100

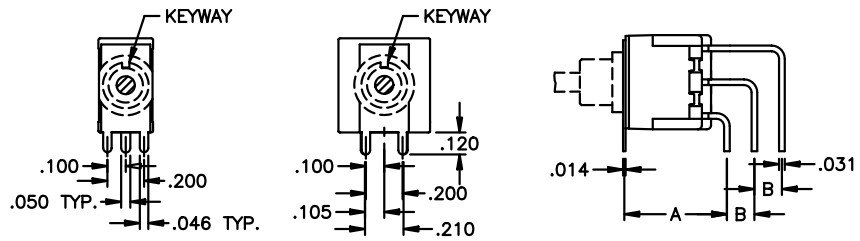

VERTICAL P.C. MOUNTING

V30, V40, V70, V80, V31, V41, V71 & V81

PANEL LAYOUT
V30, V31, V40 & V41

Option	Dim. A	Dim. B
V30-V31	.527	.024
V40-V41	.647	.048

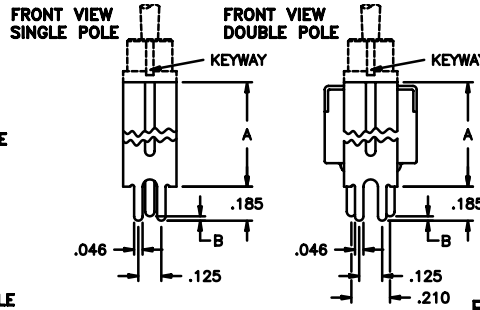
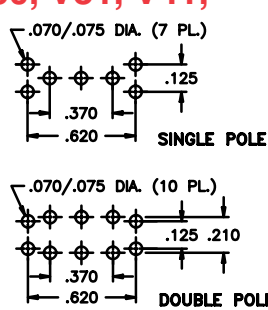

PRINTED CIRCUIT MOUNTING

PANEL LAYOUT
V70, V71,
V80 & V81

Option	Dim. A
V70-V71	.630
V80-V81	.953

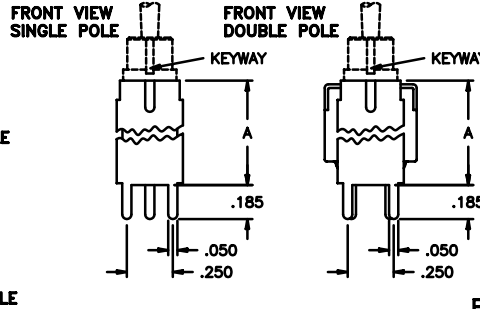
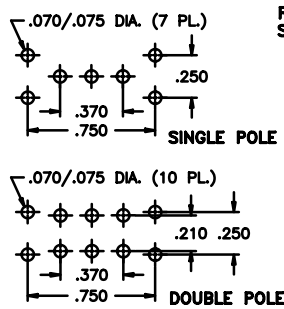

PRINTED CIRCUIT MOUNTING

V31, V41, V71 & V81 ARE THE SAME AS V30, V40, V70 & V80 RESPECTIVELY, EXCEPT WITH CRIMPED LEG DESIGN FOR P.C. BOARD RETENTION, AS SHOWN TO RIGHT.

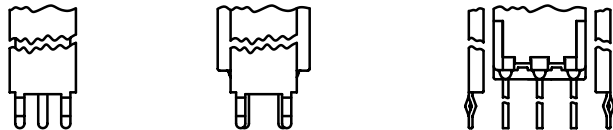

SPECIFICATIONS SUBJECT TO CHANGE WITHOUT NOTICE

Z

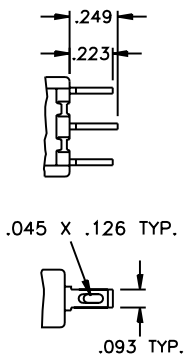

SOLDER LUG

C

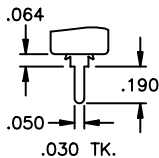

PRINTED CIRCUIT

W

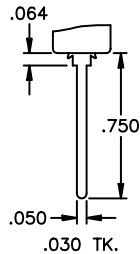

WIREWRAPE

W1

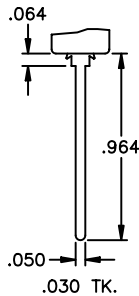

LONG WIREWRAPE

W3

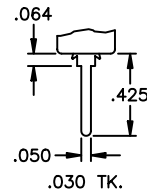

SHORT WIREWRAPE

X

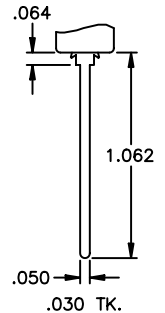

EXTRA LG. WIREWRAPE

PB SERIES - MINIATURE MOMENTARY PUSHBUTTON SWITCHES

CONTACT MATERIAL OPTIONS

- B** Dry circuit - gold over nickel over brass.
 RATING: 0.4 Volt-Amps (VA) max. at 20 V max.
 ELECTRIC LIFE: 60,000 cycles minimum. MECHANICAL LIFE: 500,000 cycles minimum.
- Q** Power circuit - coin silver.
 RATING: 6 Amps at 125 VAC, 3 Amps at 250 VAC or 7 Amps at 30 VDC (resistive loads).
 ELECTRIC LIFE: 60,000 cycles minimum at full load.
- G** Dry circuit or power circuit - gold over nickel over coin silver.
 RATINGS & ELECTRIC LIFE: Same as B & Q above - i.e. - can be used in either dry circuit or power circuit, however once used in power circuit, switch cannot be re-used in dry circuit. This option satisfies those customers who have both dry circuit and power circuit requirements, but prefer to inventory only one switch for both.
- N** Dry circuit - gold over nickel over brass. Note- less gold than B option.
 RATING: 0.4 Volt-Amps (VA) max. at 20 V max.
 ELECTRIC LIFE: 10,000 cycles min. at 13 cycles per minute.
- T** Power circuit - Silver plate over brass.
 RATING: 1 Amp at 125 VAC or 0.5 Amps at 250 VAC (resistive loads).
 ELECTRIC LIFE: 10,000 cycles min. at 13 cycles per minute.

Solder dipped terminals and custom contact plating available - contact factory.

UL & CSA OPTIONS

- UL** For power circuits - coin silver
 RATING: 6 Amps at 125 VAC or 3 Amps at 250 VAC (75% power factor).
 Underwriter Laboratories file no. E66367. Note - applicable only to terminations with coin silver contacts (Q or G options).
- CSA** For power circuits - coin silver
 RATING: 6 Amps at 125 VAC or 3 Amps at 250 VAC (75% power factor).
 Canadian Standards Association file no. LR54592-1. Note - applicable only to terminations with coin silver contacts (Q or G options) as CSA recognizes switches for power applications only.

EPOXY SEALING OPTION

- E** Space between terminals and case hole is completely epoxy sealed to prevent flux and contaminant entry.

REVERSE ACTION OPTION

- /R** To reverse the **NO** and **NC** terminals, add **/R** to the switch model number.

PANEL CUT-OUTS

Cut-outs that accept all 1/4-40 threaded bushings:

Without keying	With A107 anti-rotate ring	With A158 anti-rotate ring	With D bushing	With slotted keyway bushings	Accepts all 1/4" non-threaded bushings

MISCELLANEOUS

- QUICK-CONNECT RECEPTACLES** that are compatible with solder lug or p.c. terminals are commercially available. Consult factory.
- FRONT PANEL SEAL:** Silicone rubber boots for front panel sealing of the switch against high pressure water or other contaminants are available. See Waterproof Switch Sealing Boots section in catalog.
- SWITCH CAPS** for switches without bezels also available - see Hardware section of catalog

SPECIFICATIONS SUBJECT TO CHANGE WITHOUT NOTICE

C

13000 SERIES - QUICK-BREAK PUSHBUTTON SWITCHES

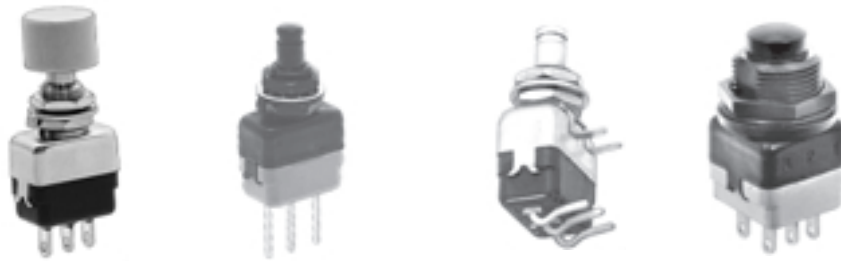

C

FEATURES

- Quick break momentary action.
- SPDT & DPDT models with 1/4" threaded bushing (also see optional 15/32" bushing).
- Models for panel and p.c. mounting.
- Bright chrome or matte black finish on bushing, actuator & hardware.

SPECIFICATIONS

Contact ratings (resistive loads):	Silver & gold plated silver; 2 Amps at 250 VAC, 4 Amps at 125 VAC or 4 Amps at 30 VDC. (300 mA 30 VDC max. to prevent damage to gold plating.) Gold plated brass; 100 mA at 30 V max.
Initial contact resistance:	10 milliohms maximum
Insulation resistance:	1000 megohms min. at 500 VDC
Dielectric strength:	1000 V rms min. - between terminals 2000 V rms min. - between poles and terminals and frame
Electrical life:	Silver: 50,000 cycles min. Gold plated silver: 20,000 cycles min. Gold plated brass: 50,000 cycles min.
Low level or mechanical life:	150,000 cycles min.
Total Travel:	.078" (2mm)
Operating temperature range:	-40°C to +85°C

MATERIALS

Contacts :	Silver, gold plated silver or gold plated brass
Actuator:	Chrome plated brass
Bushing:	Nickel plated brass
Housing:	Nickel plated brass
Case:	Diallyl phthalate (DAP)
Terminal seal:	Epoxy
Hardware:	1/4" threaded bushing models supplied with 2 Hex Nuts .314" (8mm) across flats, 1 Locking Ring & 1 Lockwasher. See hardware section of catalog.

AGENCY RECOGNITION



UL, CECC, LNZ, GAM T1, QPL (Europe), MUAHAG
Availability: Consult factory for details of recognized models.
Marking: To order switches marked CECC, complete the appropriate box of the ordering format. Other listings do not appear on the switches.

ABOUT THIS SERIES

The material in this series is organized in the following sequence:

- Completely specified switch models
- 'build your own switch' order format
- Option drawings

SPECIFICATIONS SUBJECT TO CHANGE WITHOUT NOTICE

13000 SERIES - QUICK-BREAK PUSHBUTTON SWITCHES

Solder lug terminals - silver contacts



SINGLE POLE MODEL NO.	CIRCUIT	
13435A	ON	MOM
DOUBLE POLE MODEL NO.	CIRCUIT	
13445A	ON	MOM
Handle position:		
Terms. connected: 1-3 1-2		
4-6 4-5		

→ Keyway

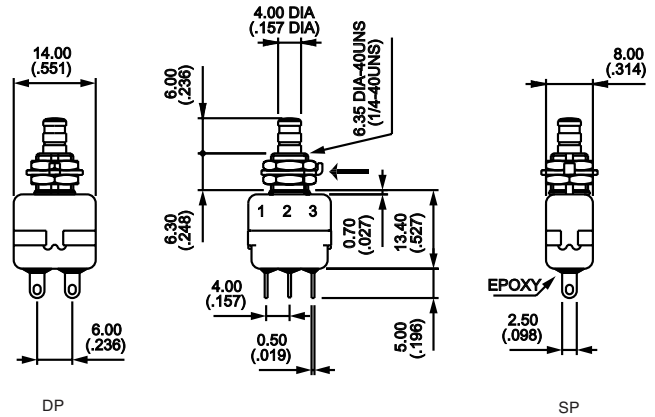

Straight p.c. terminals - silver contacts



SINGLE POLE MODEL NO.	CIRCUIT	
13235A	ON	MOM
DOUBLE POLE MODEL NO.	CIRCUIT	
13245A	ON	MOM
Handle position:		
Terms. connected: 1-3 1-2		
4-6 4-5		

→ Keyway

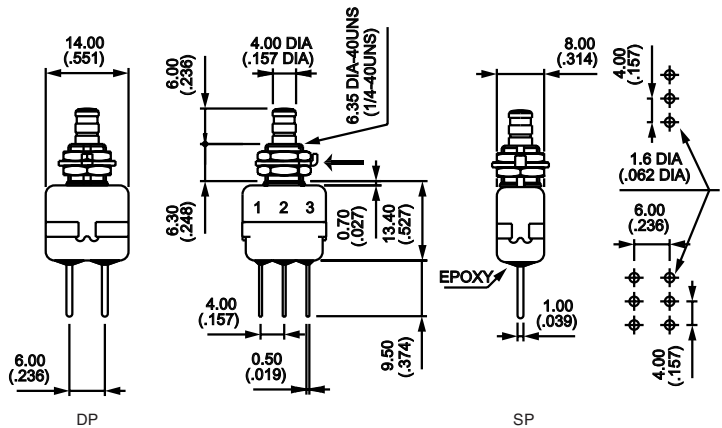

Horizontal right angle p.c. terminals - silver contacts



SINGLE POLE MODEL NO.	CIRCUIT	
13435WA	ON	MOM
Handle position:		
Terms. connected: 1-3 1-2		

→ Keyway

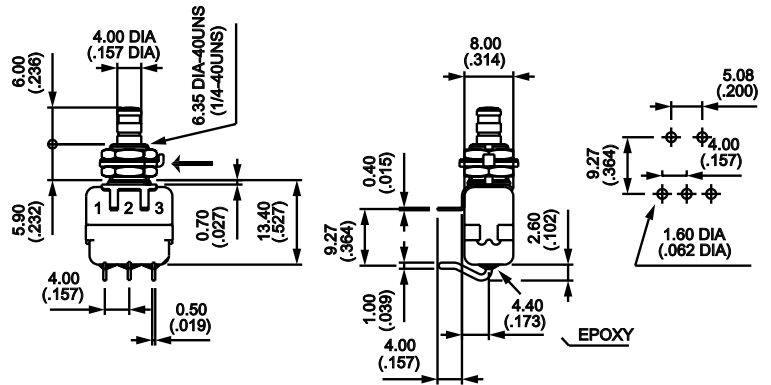

X768 - Sealed double pole with 15/32" (11.9mm) flatted bushing



With short actuator		
MODEL NO.	CIRCUIT	
13445A4X768	ON	MOM
With long actuator		
MODEL NO.	CIRCUIT	
13445A9X768	ON	MOM
Handle position:		
Terms. connected: 1-3 1-2		
4-6 4-5		

Contact and finish options available.

→ Flat

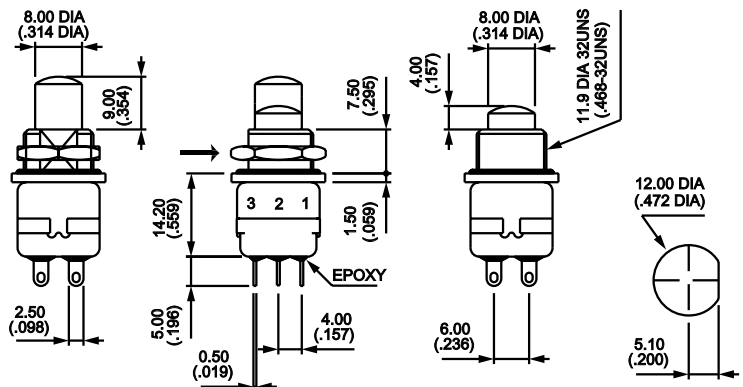

SPECIFICATIONS SUBJECT TO CHANGE WITHOUT NOTICE

C

13000 SERIES - QUICK-BREAK PUSHBUTTON SWITCHES

PANEL CUT-OUTS

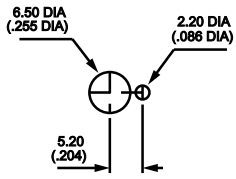

Standard

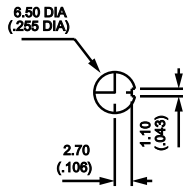

with **K** sealing option

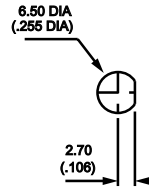

with **X640** sealing option
(see Special Options)

TERMINALS

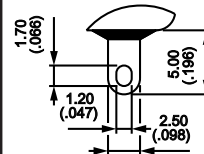

Solder Lug

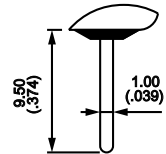

Straight p.c.

Additional ordering information: Commonly ordered models are shown on prior pages with complete model numbers and specifications. Below is an order format that enables you to 'build your own switch' and specify the correct switch model number by simply selecting from all available options shown and filling in the boxes.

'BUILD YOUR OWN SWITCH' ORDER FORMAT

Fill in boxes with selections shown for **Model Structure**, then add **Options** selections for complete model number. Allowable options are shown below each respective box. Note 'NONE' indicates box may be left empty.

Model Structure:

Series	Terminals & bushings	Number of poles	Electrical functions	Terminals	Contact materials
1 3	<input type="checkbox"/>	<input type="checkbox"/>	<input type="checkbox"/>	<input type="checkbox"/>	<input type="checkbox"/> <input type="checkbox"/> <input type="checkbox"/>
	2 Straight p.c. terminals, 1/4" (6.35mm) bushing 4 Solder lugs, 1/4" (6.35mm) or 15/32" (11.9mm) bushing. Right angle terminals, 1/4" (6.35mm) bushing	3 Single pole 4 Double pole	5 ON - MOM	(NONE) Solder lugs or straight p.c. W Horizontal right angle p.c.	A Silver A D 2 Gold plated silver (2 microns) C D Gold plated brass

Options:

Actuators	Finish	Sealing	Special options	Approvals/listings
<input type="checkbox"/>	<input type="checkbox"/>	<input type="checkbox"/>	<input type="checkbox"/> <input type="checkbox"/> <input type="checkbox"/> <input type="checkbox"/>	<input type="checkbox"/> <input type="checkbox"/> <input type="checkbox"/> <input type="checkbox"/>
(NONE) Standard for 1/4" bushing 4 .157" (4mm) long for 15/32" (11.9mm) bushing (X768) 9 .354" (9mm) long for 15/32" (11.9mm) bushing (X758)	(NONE) Bright chrome finish G Matte black finish on bushing, actuator & hardware.	(NONE) Epoxy sealed terminals std'd. K Front panel sealing with o-ring & gasket.	(NONE) F Tin plated terminals (p.c. only) X 7 6 8 15/32" (11.9mm) bushing + front panel sealing (Double pole only).	(NONE) C E C C (consult factory for details of approved models). Caps available separately - see option drawings.

Example of completely specified model number:
13235AGKFCECC

SWITCH ACTION

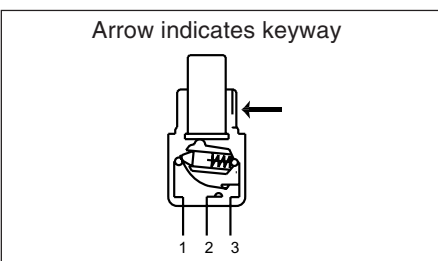

SPECIFICATIONS SUBJECT TO CHANGE WITHOUT NOTICE

13000 SERIES - QUICK-BREAK PUSHBUTTON SWITCHES

SPECIAL & SEALING OPTIONS

- F** Tin plated terminals (for p.c. terminals only).
- K** Front panel sealing with 'o'-ring (1) & sealing gasket (2). Protects switch against water & dust. Panel seal withstands 1 bar pressure even when switch is operated.
- X640** Front panel sealing with 3 'o'-rings (1) & flatted bushing. Protects switch against water & dust. Panel seal withstands 1 bar pressure even when switch is operated. (Available with 1/4" (6.35mm) bushing only).

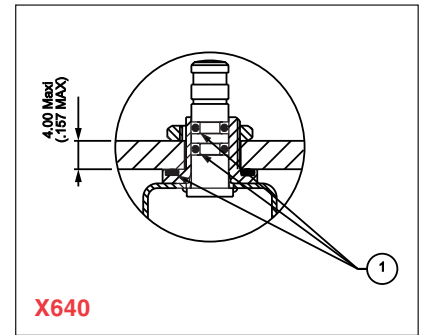
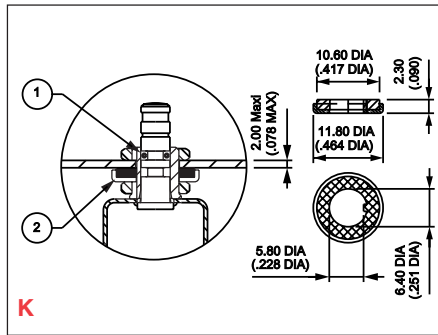

SPECIFICATIONS SUBJECT TO CHANGE WITHOUT NOTICE

C

CAPS

Note: replace last '0' in p/n with color code.

<p>U900</p>	<p>U1140</p>	<p>U1720</p>	<p>U480 Standard</p>																				
<p>U630</p>	<p>U2020 Square</p>	<p>U2430 Square</p>	<table border="1" style="margin: auto;"> <thead> <tr> <th colspan="2">Colors</th> </tr> </thead> <tbody> <tr><td>1</td><td>blue</td></tr> <tr><td>2</td><td>black</td></tr> <tr><td>3</td><td>green</td></tr> <tr><td>4</td><td>grey</td></tr> <tr><td>5</td><td>yellow</td></tr> <tr><td>6</td><td>red</td></tr> <tr><td>7</td><td>ivory</td></tr> <tr><td>7/1</td><td>white</td></tr> <tr><td>9</td><td>orange</td></tr> </tbody> </table>	Colors		1	blue	2	black	3	green	4	grey	5	yellow	6	red	7	ivory	7/1	white	9	orange
Colors																							
1	blue																						
2	black																						
3	green																						
4	grey																						
5	yellow																						
6	red																						
7	ivory																						
7/1	white																						
9	orange																						

DRESS NUTS

Chrome plated For models with 1/4" (6.35mm) threaded bushings only.

<p>U1636 For cap U1140</p>	<p>U840 For cap U480</p>	<p>U825 For cap U630</p>
-----------------------------------	---------------------------------	---------------------------------

New! 13000 SERIES - PUSH/PULL PUSHBUTTON SWITCHES

C



FEATURES

- Unique ergonomic actuator .976" (24.8mm) diameter.
- High mechanical strength with double shell case option.
- O-ring sealed around actuator and at front panel interface, and epoxy sealed terminals.
- Requires minimal back-of-panel space.

SPECIFICATIONS

Contact ratings (resistive loads):	4 Amps at 24 VDC
Initial contact resistance:	10 milliohms maximum
Insulation resistance:	1000 megohms min. at 500 VDC
Dielectric strength:	1000 V rms min. - between terminals 2000 V rms min. - between poles and terminals and frame
Electrical life:	10,000 cycles min.
Total travel:	.078" (2mm)
Operating force:	Push; 4.5±1.1 lbs. (20±5N) Pull; 4.7±1.4 lbs. (21±6N)
Shock:	50g per IEC 68-2-27
Vibration:	10-500 Hz - 10g per IEC 68-2-6
Moisture resistance:	56 days per IEC 68-2-3
Operating temperature range:	-40°C to +85°C

MATERIALS

Contacts :	Gold plated silver (2 microns gold)
Actuator dome:	Red anodized aluminum
Actuator, bushing & nut:	Black chrome plated brass
Terminal seal:	Epoxy
Hardware:	One 15mm Hex Nut, .708" (18mm) across flats supplied

AGENCY RECOGNITION

CECC, LNZ, GAM T1, QPL (Europe), MUAHAG
 Availability: Consult factory for details of recognized models.

DOUBLE POLE

With double shell case
13440AD2G-25X1156+U4546
 Without double shell case
13440AD2G-25X822+U4546

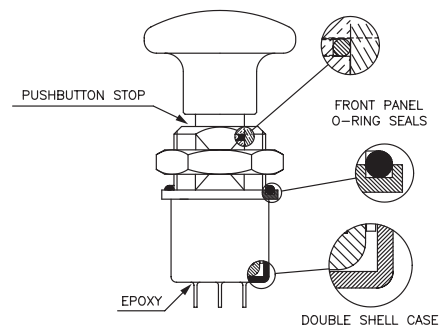
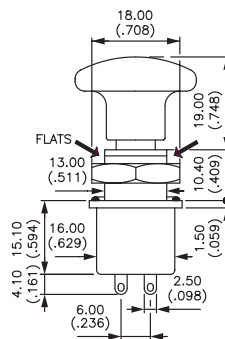
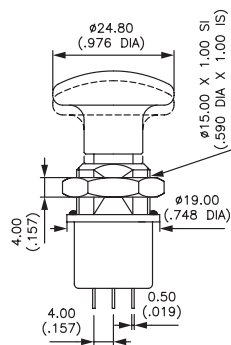

SPECIFICATIONS SUBJECT TO CHANGE WITHOUT NOTICE

13000X778 SERIES - HIGH PERFORMANCE PUSHBUTTON SWITCHES



FEATURES

- Designed for high reliability environments.
- Double shell case for high mechanical strength & high electrical insulation.
- Quick break momentary action DPDT models with 15/32" (11.9mm) threaded bushing.
- Panel sealed to IP67 and fully sealed switch body.
- Highly reliable for low level or power applications.
- Matte black finish on body, bushing, actuator and hardware.

SPECIFICATIONS

Contact ratings (resistive loads):	Silver & gold plated silver; 2 Amps at 250 VAC, 4 Amps at 125 VAC or 4 Amps at 28 VDC. (300 mA 30 VDC max. to prevent damage to gold plating.) Minimum load - 10 mA at 50 mV, 10 μ A at 5 VDC
Initial contact resistance:	10 milliohms maximum
Insulation resistance:	1000 megohms min. at 500 VDC
Dielectric strength:	1000 V rms min. - between terminals 2000 V rms min. - between poles and between terminals and frame
Electrical life:	At 2A 250VAC or 4A 28VDC - 10,000 cycles. At low level (50mV at 10mA) - 20,000 cycles
Total Travel:	.078" (2mm)
Operating temperature range:	-40°C to +85°C
Environmental:	Shock: 50g - 11ms (IEC 68-2-27). Vibration: 10-500 Hx - 10g (IEC68-2-6) Salt spray: 96 hrs. (IEC68-2-11). Humidity: 56 days, 93% R.H., 40°C (IEC68-2-3)

MATERIALS

Contacts :	Silver inlay - gold plated over nickel barrier
Actuator:	Black chrome plated brass
Bushing:	Black chrome plated brass
Case:	Diallyl phthalate (DAP) with PBT external shell, epoxy sealed
Hardware:	Supplied with 1 Hex Nut with black finish p/n U41. See drawing at end of section.

AGENCY RECOGNITION

CECC, GAM, QPL (Europe), MUAHAG & DAT (French defense military). Marking: Many models have full CECC recognition and are marked CECC. Consult factory for list of recognized models.

ABOUT THIS SERIES

The material in this series is organized in the following sequence:

- a. Completely specified switch models
- b. 'build your own switch' order format
- c. Miscellaneous

13000X778 SERIES - HIGH PERFORMANCE PUSHBUTTON SWITCHES

C

Double pole - solder lug terminals - .157" (4mm) actuator



MODEL NO.	CIRCUIT
134454X778	ON MOM
Handle position:	

→ Flat

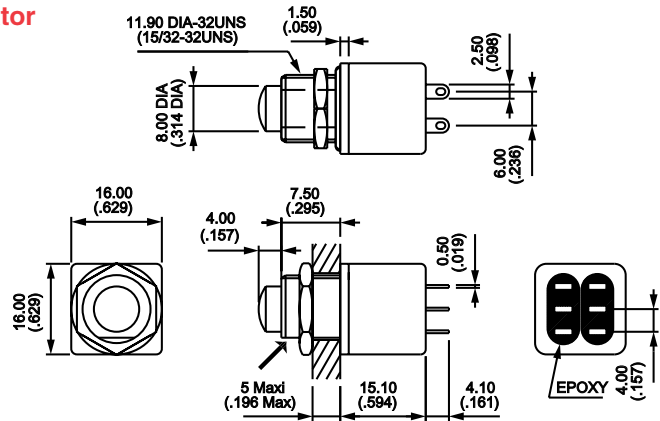

Double pole - solder lug terminals - .354" (9mm) actuator



MODEL NO.	CIRCUIT
134459X778	ON MOM
Handle position:	

→ Flat

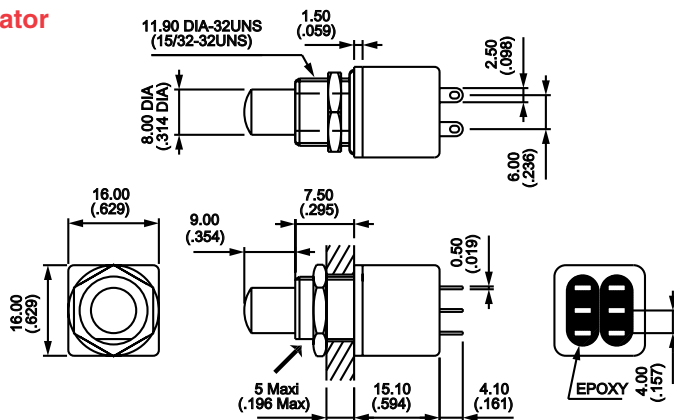

Double pole - straight p.c. terminals - .157" (4mm) actuator



MODEL NO.	CIRCUIT
132454X778	ON MOM
Handle position:	

→ Flat

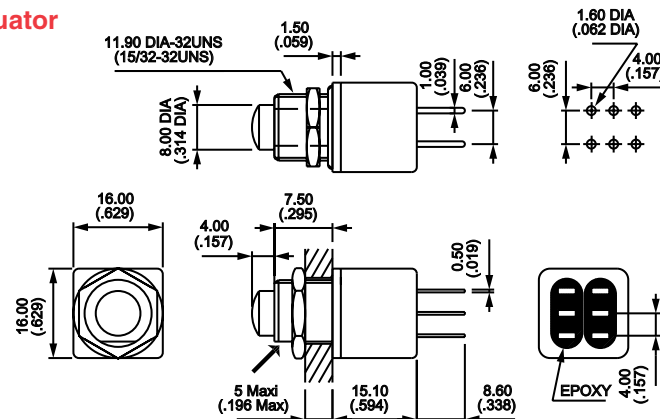

Double pole - straight p.c. terminals - .354" (9mm) actuator



MODEL NO.	CIRCUIT
132459X778	ON MOM
Handle position:	

→ Flat

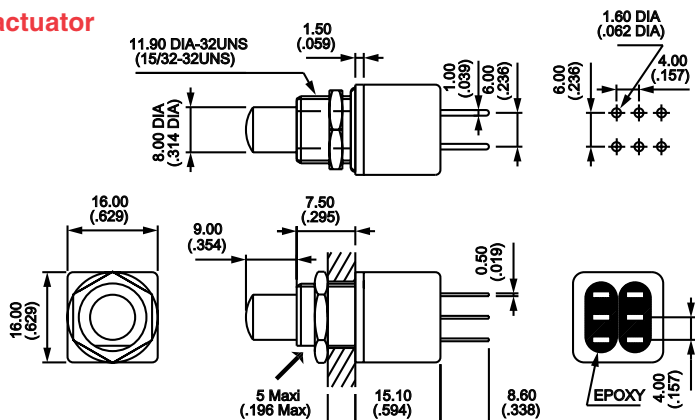

SPECIFICATIONS SUBJECT TO CHANGE WITHOUT NOTICE

13000X778 SERIES - HIGH PERFORMANCE PUSHBUTTON SWITCHES

Additional ordering information: Commonly ordered models are shown on prior pages with complete model numbers and specifications. Below is an order format that enables you to 'build your own switch' and specify the correct switch model number by simply selecting from all available options shown and filling in the boxes.

'BUILD YOUR OWN SWITCH' ORDER FORMAT

Fill in boxes with selections shown for **Model Structure**, then add **Options** selections for complete model number. Allowable options are shown below each respective box. Note 'NONE' indicates box may be left empty.

Model Structure:

Series	Terminals & bushing	Number of poles	Electrical function	Actuator	Special options
1 3	<input type="checkbox"/>	<input type="checkbox"/>	<input type="checkbox"/>	<input type="checkbox"/>	X 7 7 8
	2 Straight p.c. terminals, 15/32" (11.9mm) threaded bushing 4 Solder lug terminals, 15/32" (11.9mm) threaded bushing.	4 Double pole	5 ON - MOM	4 .157" (4mm) long 9 .354" (9mm) long	High performance fully sealed matte black switch

Options:

Approvals/listings

<input type="checkbox"/>	<input type="checkbox"/>	<input type="checkbox"/>	<input type="checkbox"/>
--------------------------	--------------------------	--------------------------	--------------------------

(NONE)

C E C C (consult factory for details of approved models).

Example of completely specified model number:
132454X778CECC

POSITIONS AND CONNECTIONS

Button position

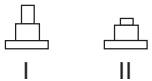

Connections

ON	MOM
A 1-2	A 1-3
B 1-2	B 1-3

Terminal identification
Arrow indicates flat

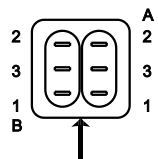

SWITCH ACTION

Arrow indicates flat

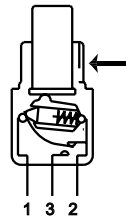

TERMINALS

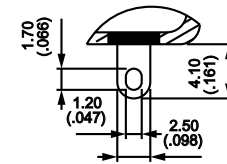

Solder lug

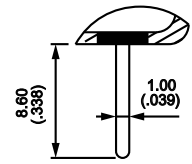

Straight p.c.

SEALING

Standard on all models:

3 'o'-rings (1) seal front panel and withstand 1 bar pressure, even when switch is operated.

Epoxy sealed terminals.

Splash-proof case.

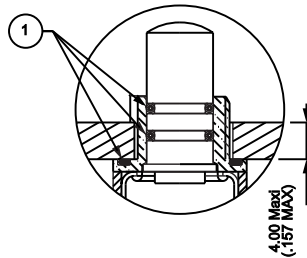

PANEL CUT-OUT

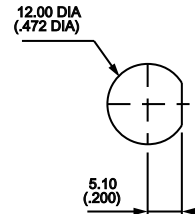

Panel thickness:
.196" (5mm) max.

HARDWARE

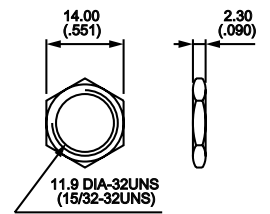

U41 matte black Hex Nut

SPECIFICATIONS SUBJECT TO CHANGE WITHOUT NOTICE

C

1200 SERIES - MOMENTARY PUSHBUTTON SWITCHES



C

FEATURES

- Single pole panel mounting models.
- NC & NO electrical functions with double break.
- Solder lug, screw, screw with clamp and right angle screw with clamp terminals.
- 4 optional actuator colors.

SPECIFICATIONS

Contact ratings (resistive loads):	4 Amps at 250 VAC, 8 Amps at 125 VAC or 4 Amps at 24 VDC	
Initial contact resistance:	10 milliohms max. at 1A 2VDC	
Insulation resistance:	1000 megohms minimum at 500 VDC	
Dielectric strength:	2000 V rms min. between terminals. 3000 V rms between terminals & frame	
Electrical life:	10,000 cycles at full load	
Operating temperature range:	-20°C to +55°C	
Total travel:	NO: .177" (4.5mm) ± .011" (0.3mm)	NC: .137" (3.5mm) ± .011" (0.3mm)

MATERIALS

Contacts:	Silver
Actuator:	Polyamide
Case:	Polyamide
Bushing:	Nickel plated brass
Hardware:	Supplied with 1 Hex Nut p/n U166 & 1 Knurled Nut p/n U411. See hardware section of catalog.

AGENCY RECOGNITION



Model no's. with 'UU' are UL & CSA recognized.
 Models 1233X209 & 1233X209L are VDE recognized.
 Marking: Switches are supplied with recognitions marked.

Solder lug/quick-connect terminals



1212A2		Normally Closed
1213A2UU		Normally Open

The '2' following the 'A' in model no. indicates black actuator. Substitute '6' for red or '7/1' for white, if desired.

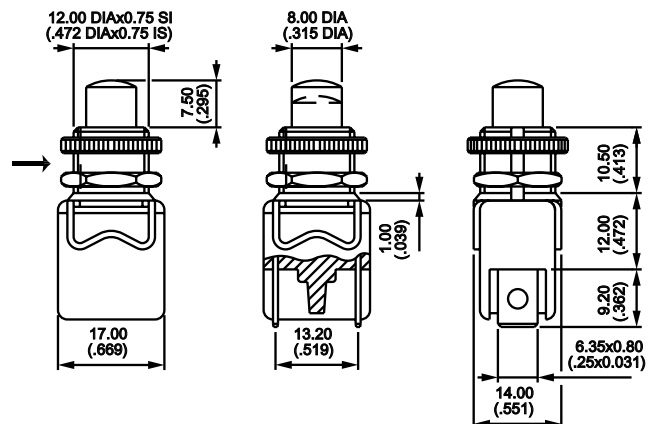

SPECIFICATIONS SUBJECT TO CHANGE WITHOUT NOTICE

1200 SERIES - MOMENTARY PUSHBUTTON SWITCHES

Screw terminals



1222A2  Normally Closed

1223A2UU  Normally Open

The '2' following the 'A' in model no. indicates black actuator. Substitute '6' for red or '7/1' for white, if desired.

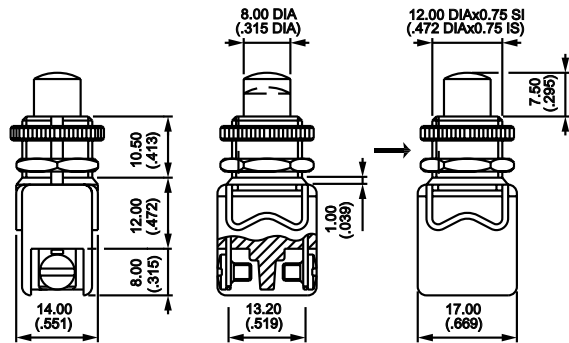

→ Keyway

Straight screw terminals and clamp



1202A2  Normally Closed

1203A2UU  Normally Open

The '2' following the 'A' in model no. indicates black actuator. Substitute '6' for red or '7/1' for white, if desired.

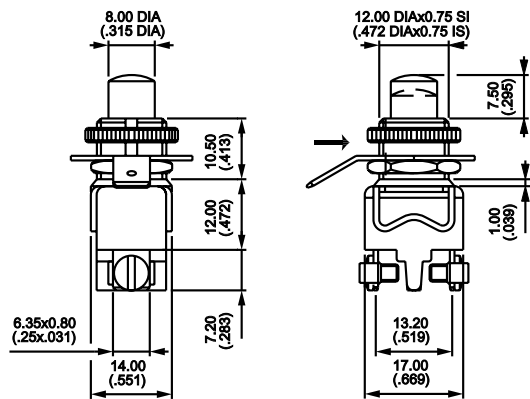

→ Keyway

Right angle screw terminals and clamp



12037A2UU  Normally Open

The '2' following the 'A' in model no. indicates black actuator. Substitute '6' for red or '7/1' for white, if desired.

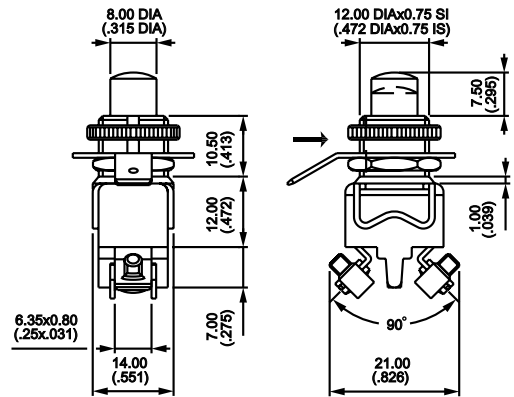

→ Keyway

X209 - UL, CSA, VDE, SEMCO & NF-USE approved - solder lug/quick connect terminals

(Note- U187 ground connector ring required if panel is not metallic or not connected to ground. Order separately).



1233A2X209UU  Normally Open

The '2' following the 'A' in model no. indicates black actuator. Substitute '6' for red or '7/1' for white, if desired.

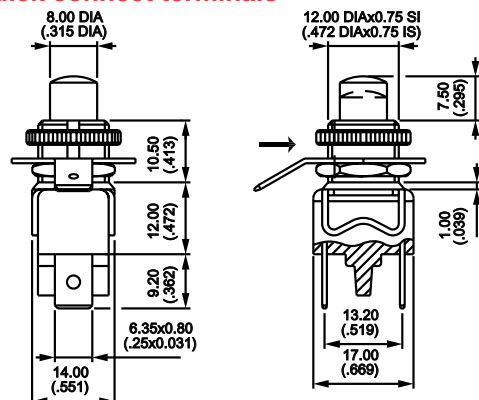

→ Keyway

SPECIFICATIONS SUBJECT TO CHANGE WITHOUT NOTICE

C

1200 SERIES - MOMENTARY PUSHBUTTON SWITCHES

X209 - UL, CSA, VDE, SEMCO & NF-USE approved - solder lug/quick connect terminals

(Note- U187 ground connector ring required if panel is not metallic or not connected to ground. Order separately).



1233A2X209LUU

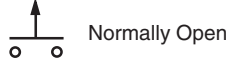

The '2' following the 'A' in model no. indicates black actuator. Substitute '6' for red or '7/1' for white, if desired.

→ Keyway

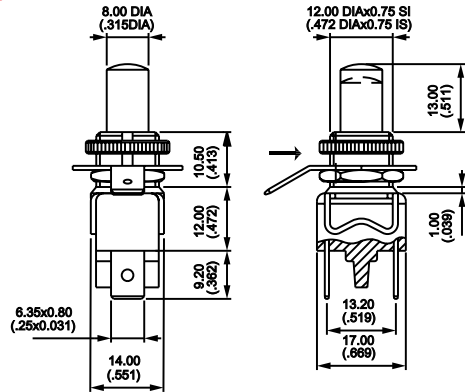

SWITCH ACTION

Arrow indicates keyway

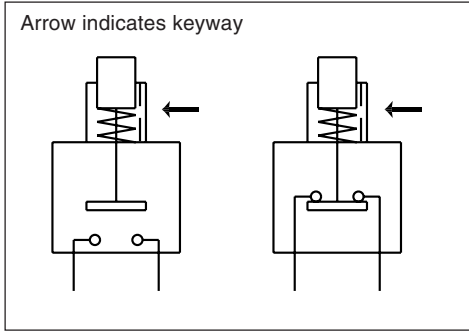

TERMINALS

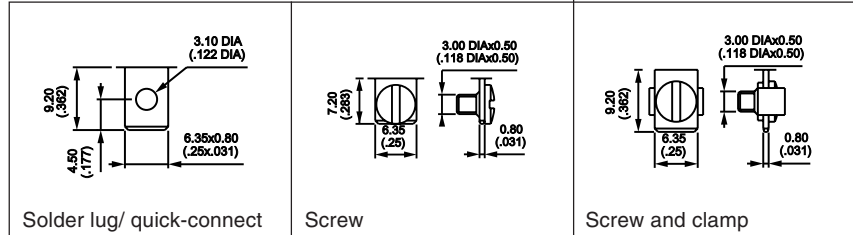

PANEL CUT-OUT: .480" (12.2mm) dia.

GROUND CONNECTOR RING U187

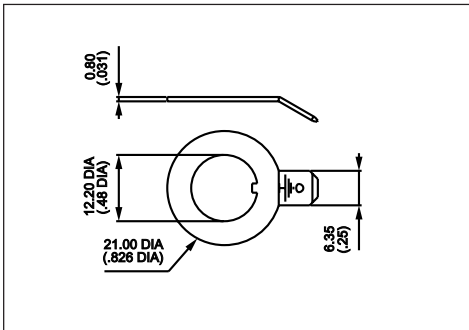

SPECIFICATIONS SUBJECT TO CHANGE WITHOUT NOTICE

1200M & 1200MR SERIES - MOMENTARY PUSHBUTTON SWITCHES



FEATURES

- Single pole panel mounting models.
- NC & NO electrical functions with double break.
- Solder lug, screw and screw with clamp terminals.
- Chrome plated domed or flat metal actuators .

SPECIFICATIONS

Contact ratings (resistive loads):	4 Amps at 250 VAC, 8 Amps at 125 VAC or 4 Amps at 24 VDC	
Initial contact resistance:	10 milliohms max. at 1A 2VDC	
Insulation resistance:	1000 megohms minimum at 500 VDC	
Dielectric strength:	2000 V rms min. between terminals. 3000 V rms between terminals & frame	
Electrical life:	10,000 cycles at full load	
Operating temperature range:	-20°C to +55°C	
Total travel:	NO: .177" (4.5mm) ± .011" (0.3mm)	NC: .137" (3.5mm) ± .011" (0.3mm)

MATERIALS

Contacts:	Silver
Actuator:	Chrome plated brass on polyamide base
Case:	Polyamide
Bushing:	Nickel plated brass
Hardware:	Supplied with 1 Hex Nut p/n U166 & 1 Panel Dress Nut U1868

AGENCY RECOGNITION



Model no's. with 'UU' are UL & CSA recognized.
Marking: Switches are supplied with recognized marks.

Solder lug/quick-connect terminals



1212MA  Normally Closed

1213MAUU  Normally Open

The 'M' in model no. indicates flat actuator.
Substitute 'MR' for domed actuator, if desired.

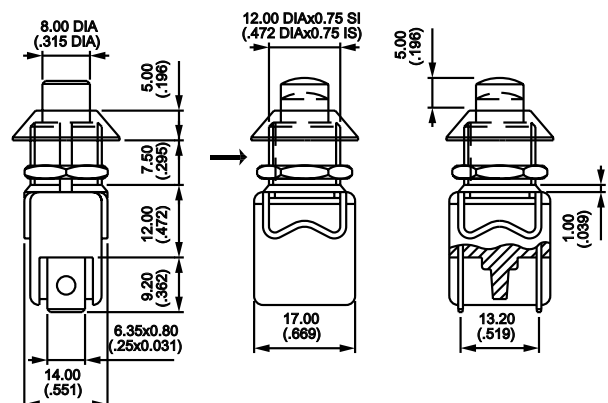

→ Keyway

1200M & 1200MR SERIES - MOMENTARY PUSHBUTTON SWITCHES

Screw terminals



1222MA  Normally Closed

1223MAUU  Normally Open

The 'M' in model no. indicates flat actuator.
Substitute 'MR' for domed actuator, if desired.

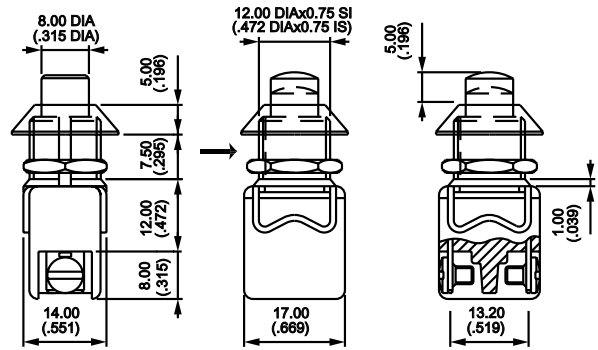

→ Keyway

Straight screw terminals and clamp



1202MA  Normally Closed

1203MAUU  Normally Open

The 'M' in model no. indicates flat actuator.
Substitute 'MR' for domed actuator, if desired.

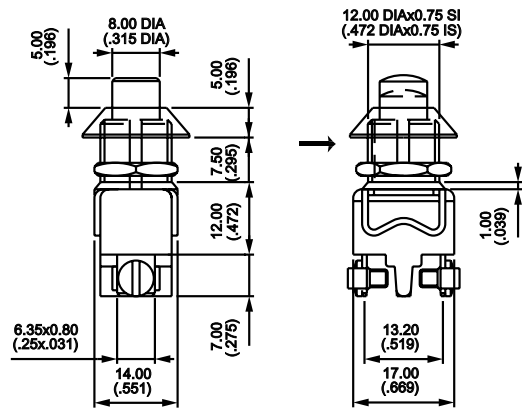

→ Keyway

SWITCH ACTION

Arrow indicates keyway

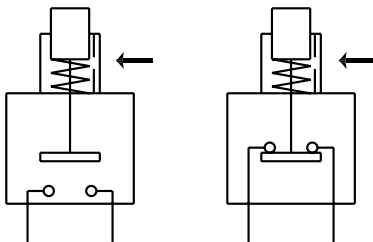

TERMINALS

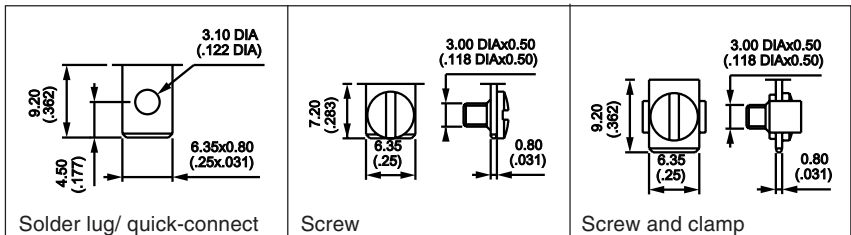

PANEL CUT-OUT: .480" (12.2mm) dia.

SPECIAL CAP NUT

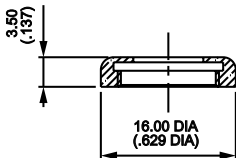

U1874 Chrome plated cap nut, flat & plain
May be ordered in place of panel dress nut.
Order separately.

SPECIFICATIONS SUBJECT TO CHANGE WITHOUT NOTICE

4700 & 4800 SERIES - MOM. & ALT. ACTION PUSHBUTTON SWITCHES



FEATURES

- Single and double pole panel mounting models.
- ON-OFF & ON-ON alternate actions and OFF-MOM momentary action.
- Solder lug, straight p.c. and quick-connect terminals.
- 7 optional actuator colors with matching knurled mounting nut.
- Acuator returns to upper position after actuation.

SPECIFICATIONS

Contact ratings (resistive loads):	3 Amps at 250 VAC or 6 Amps at 125 VAC
Initial contact resistance:	10 milliohms max. at 1A 2VDC
Insulation resistance:	1000 megohms minimum at 500 VDC
Dielectric strength:	2000 V rms min. between terminals. 3000 V rms between terminals & frame
Electrical life:	10,000 cycles at full load
Operating temperature range:	-20°C to +65°C
Total travel:	.177" (4.5mm) ± .019" (0.5mm)

MATERIALS

Contacts:	Silver
Actuator & bushing:	Polyamide
Case:	Melamine-phenolic
Hardware:	Supplied with 1 Hex Nut p/n U166 and 1 insulating Knurled Nut p/n U520. Knurled Nut supplied same color as actuator. See hardware section of catalog.

AGENCY RECOGNITION



Models ending in 'AUU' are UL, CSA and VDE recognized.
 Models 4831A, 4836A, 4841A & 4846A are VDE recognized.
 Marking: Switches are supplied with recognitions marked.

ORDER FORMAT

Fill in boxes below, for complete model number.

Model Number **Actuator & knurled nut color**

--	--	--	--	--

Select model number from those shown on next page.

- | | |
|---------|--------|
| 0 1 | blue |
| 0 2 | black |
| 0 3 | green |
| 0 5 | yellow |
| 0 6 | red |
| 0 7 / 1 | white |
| 0 9 | orange |

4700 & 4800 SERIES - MOM. & ALT. ACTION PUSHBUTTON SWITCHES

Solder lug/quick-connect terminals



SINGLE POLE MODEL NO.	DOUBLE POLE MODEL NO.	CIRCUIT
4731AUU	4741AUU	ON - OFF
4736AUU	4746AUU	ON - ON
4733AUU	4743AUU	OFF - MOM

Note: add color to model number - see Order Format, prior page.

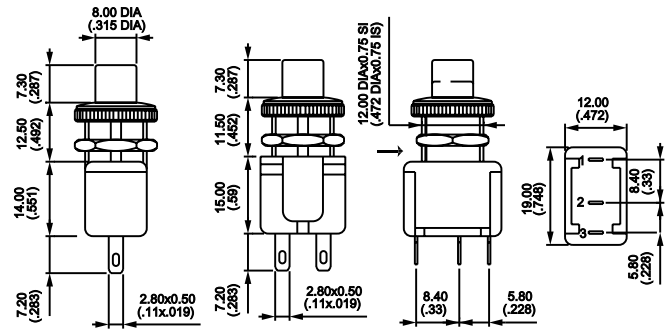

→ Keyway

SP

DP

SP

Straight p.c. terminals



SINGLE POLE MODEL NO.	DOUBLE POLE MODEL NO.	CIRCUIT
4831A	4841A	ON - OFF
4836A	4846A	ON - ON
4833A	4843	OFF - MOM

Note: add color to model number - see Order Format, prior page.

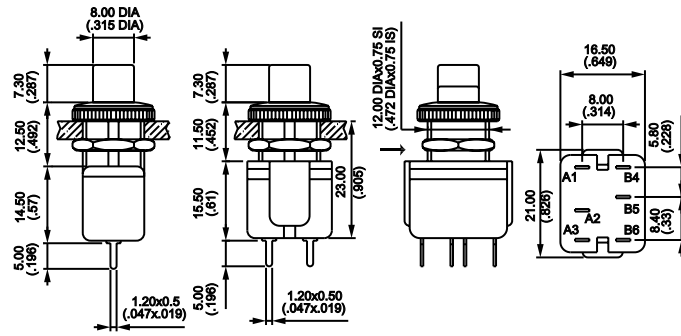

→ Keyway

SP

DP

DP

Quick-connect terminals - .185" x .031" (4.7mm x 0.8mm)



SINGLE POLE MODEL NO.	CIRCUIT
47318AUU	ON - OFF
47368AUU	ON - ON
47338AUU	OFF - MOM

Note: add color to model number - see Order Format, prior page.

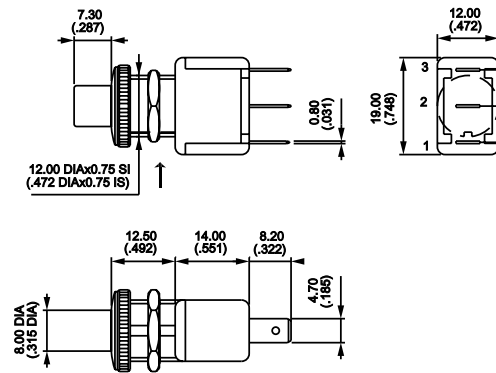

→ Keyway

SWITCH ACTION

Arrow indicates keyway

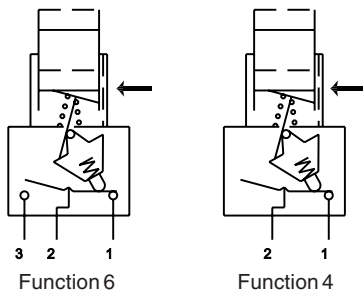

TERMINALS

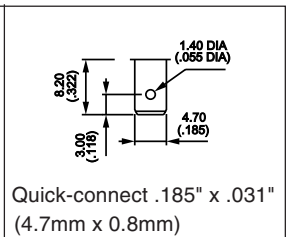
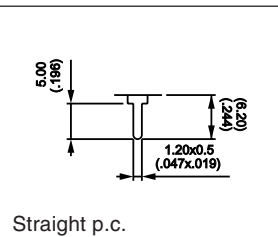
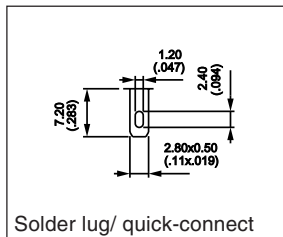

PANEL CUT-OUT: .480" (12.2mm) dia.

SPECIFICATIONS SUBJECT TO CHANGE WITHOUT NOTICE

MD SERIES - PUSHBUTTON SWITCHES

FEATURES

- Momentary or maintained actions.
- 1, 2 & 4 pole 2 throw models.
- Printed circuit & panel mounting models.
- Self-cleaning bifurcated contacts.

SPECIFICATIONS

Contact ratings (resistive loads):	200 mA at 30 VDC
Initial contact resistance:	20 milliohms maximum
Insulation resistance:	100 megohms minimum at 500 VDC
Dielectric strength:	Type 5: 500 VAC for 1 minute. Type 8: 250 VAC for 1 minute.
Electrical life:	10,000 cycles minimum
Operating temperature range:	-20°C to +85°C
Operating force:	Type 5: 300g ± 150g Type 8: 330g ± 150g

MATERIALS

Terminals:	Silver plated brass
Actuator:	Polyacetal
Frame:	Steel with tin plating
Base:	Phenolic laminated sheet
Sliding contact:	Silver plated phosphor bronze

MDPS522PN (MOMENTARY)
MDPA522PN (MAINTAINED)

2P2T P.C. MOUNTING

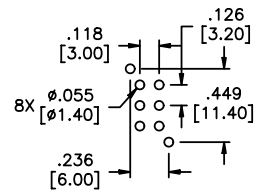
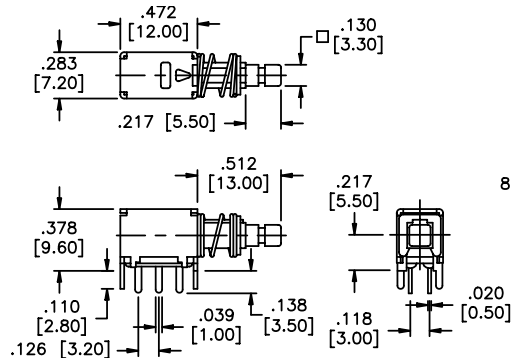
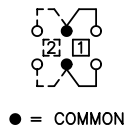

SCHEMATIC

MECHANICAL OUTLINE

P.C. BOARD LAYOUT

SPECIFICATIONS SUBJECT TO CHANGE WITHOUT NOTICE

C

MD SERIES - PUSHBUTTON SWITCHES

C

MDPS522WN (MOMENTARY)
MDPA522WN (MAINTAINED)



2P2T PANEL MOUNTING

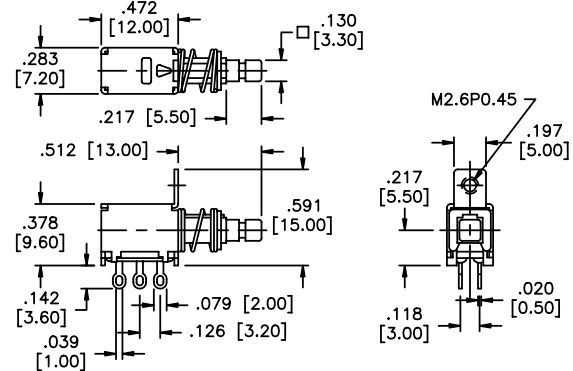
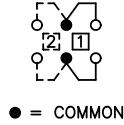

SCHEMATIC

MECHANICAL OUTLINE

MDPS542PN (MOMENTARY)
MDPA542PN (MAINTAINED)



4P2T P.C. MOUNTING

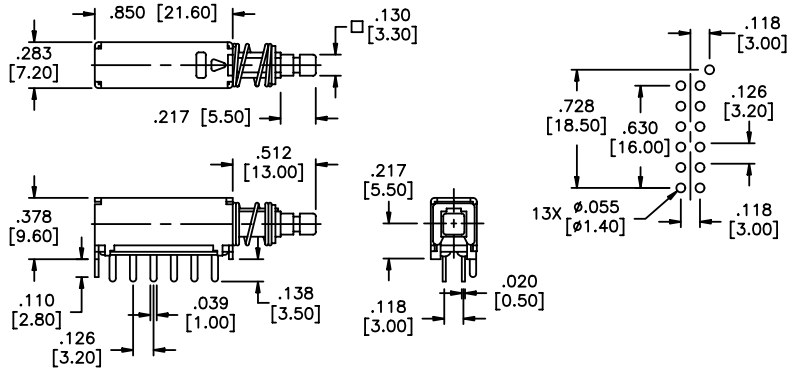
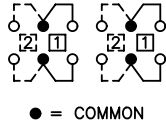

SCHEMATIC

MECHANICAL OUTLINE

P.C. BOARD LAYOUT

MDPS542WN (MOMENTARY)
MDPA542WN (MAINTAINED)

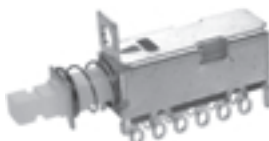

4P2T PANEL MOUNTING

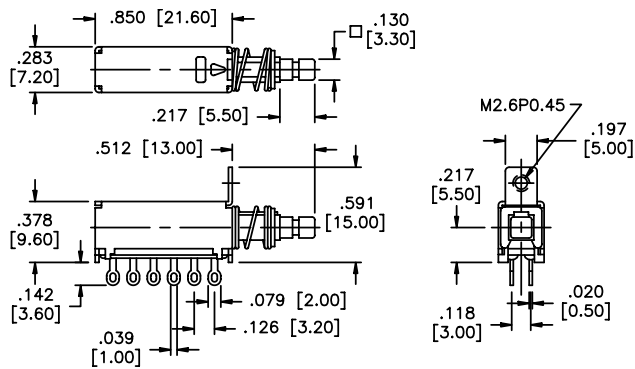
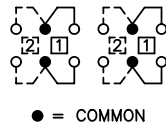

SCHEMATIC

MECHANICAL OUTLINE

MDPS822PN (MOMENTARY)
MDPA822PN (MAINTAINED)



2P2T P.C. MOUNTING

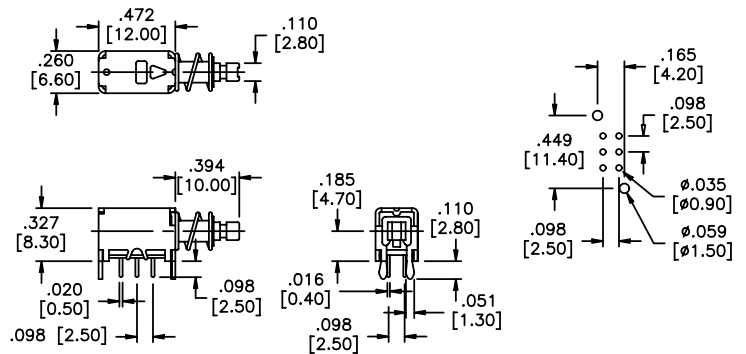
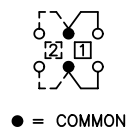

SCHEMATIC

MECHANICAL OUTLINE

P.C. BOARD LAYOUT

SPECIFICATIONS SUBJECT TO CHANGE WITHOUT NOTICE

MD SERIES - PUSHBUTTON SWITCHES

Additional ordering information: Commonly ordered models are shown above with complete model numbers and specifications. Below is an order format that enables you to 'build your own switch' and specify the correct switch model number by simply selecting from all available options shown and filling in the boxes.

'BUILD YOUR OWN SWITCH' ORDER FORMAT

Fill in boxes with selections shown for complete model number.
(Allowable options are shown under each respective box).

TYPE 5:

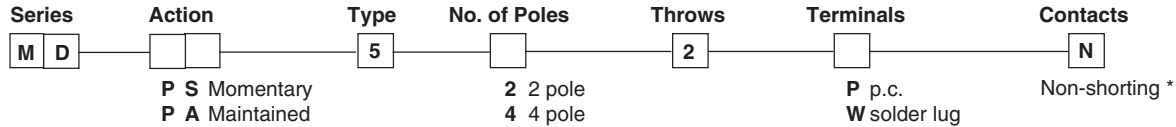

*Shorting available-consult factory.

TYPE 8:

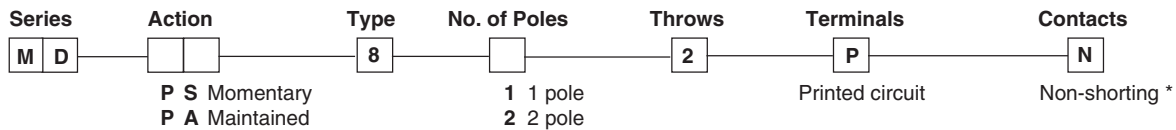

Example of completely specified model number: **MDPS542WN**

TERMINAL CONFIGURATIONS

COLOR KNOBS FOR TYPE 8 MODELS

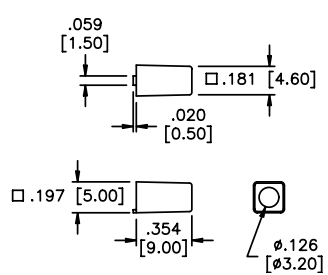
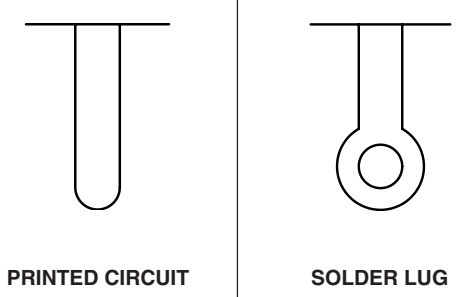

MODEL NO.	COLOR
C152	Black
C154	Gray
C156	Red

New! SNAP FIT CAPS FOR TYPE 5 MODELS (order separately)

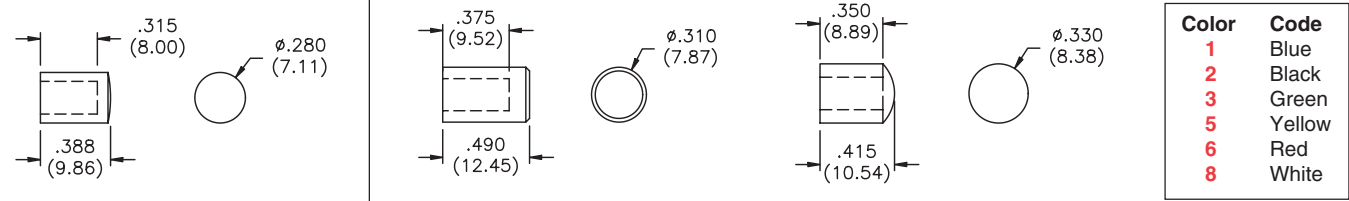

C7 Natural aluminum **C80** Thermoplastic **C90** Thermoplastic
C7A Black aluminum Replace 0 in above model numbers with color code from chart

SPECIFICATIONS SUBJECT TO CHANGE WITHOUT NOTICE



MD2 SERIES - PUSHBUTTON SWITCHES

FEATURES

- Power ratings include TV-5
- Single pole single throw alternate action.
- UL, CSA, VDE and SEMKO recognized.
- Panel mounting with threaded mounting holes and p.c. mounting with restraining bracket.

MATERIALS

Base: Phenolic, UL94V-O
 Frame: Zinc plated steel (panel mtg. models)
 Tin plated steel (p.c. mtg. models)
 Actuator: PBT, nylon 66, UL94V-2 min.
 Terminals: Silver plated copper alloy
 Contacts: Silver copper alloy

GENERAL SPECIFICATIONS

ELECTRICALS

Contact ratings: UL & CSA: 15 amps @ 125 VAC, 10 amps @ 250 VAC, TV-5
 VDE & SEMCO: 5A/80A @ 250 VAC μ T85
 Insulation resistance: 100 megohms min. (500 VDC)
 Dielectric withstanding voltage: 1000 VAC for 1 minute
 Contact resistance: 20 milliohms max.
 Electrical life: 10,000 cycles min.
 Mechanical life: 30,000 cycles min.

MECHANICALS, THERMALS

Actuation force: 400 grams \pm 200 grams
 Operating temperature range: -10 °C to +85 °C

SOLDERING

Solder heat resistance: 230°C max. for 3 \pm 0.5 seconds

MD2BM4T0



PANEL MOUNTING WITH
SOLDER LUG TERMS.

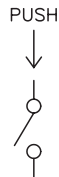

SCHEMATIC

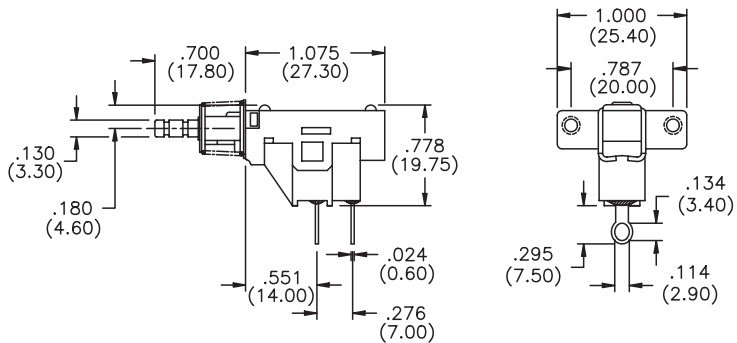

MECHANICAL OUTLINE

MD2CP4T3



P.C. MOUNTING

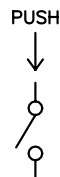

SCHEMATIC

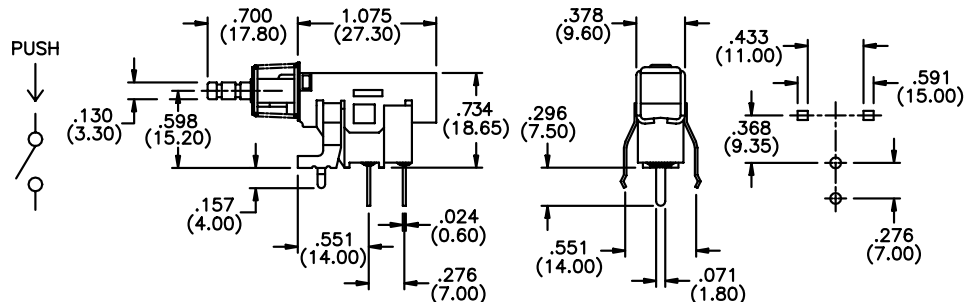

MECHANICAL OUTLINE

P.C. BOARD LAYOUT

SPECIFICATIONS SUBJECT TO CHANGE WITHOUT NOTICE.

New! 1400N SERIES - MOM. SNAP-IN PUSHBUTTON SWITCHES

FEATURES

- Snap-in mounting with square actuator.
- Single pole NO, NC & NC/NO actions.
- Solder lug, straight p.c. or quick-connect terminals.

MATERIALS

Case: Polyamide, black
 Actuator: Polyamide
 Contacts: Silver plated copper

SPECIFICATIONS

Maximum ratings (resistive load):	2 Amps @250VAC pr 4 Amps @125VAC
Initial contact resistance:	10 milliohms at 1A 2VDC
Insulation resistance:	1000 megohms min. (500 VDC)
Dielectric withstanding voltage:	1500 Vrms between terminals - 2000 Vrms between terminals & metal panel
Electrical life:	10,000 cycles min.
Panel thickness:	.078" (2mm) max.
Operating temperature range:	-20 °C to +55 °C

Solder lug or quick-connect terminals

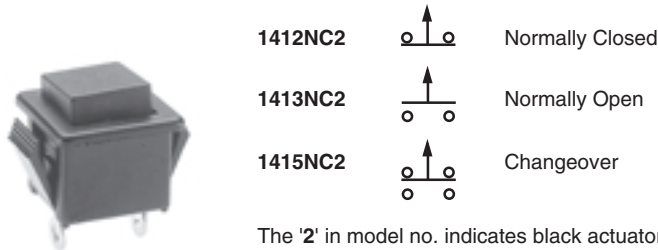

The '2' in model no. indicates black actuator. Substitute '3' for green, '6' for red or '7' for ivory, if desired. Substitute 'N8' for 'N' in model number for quick-connect terminals.

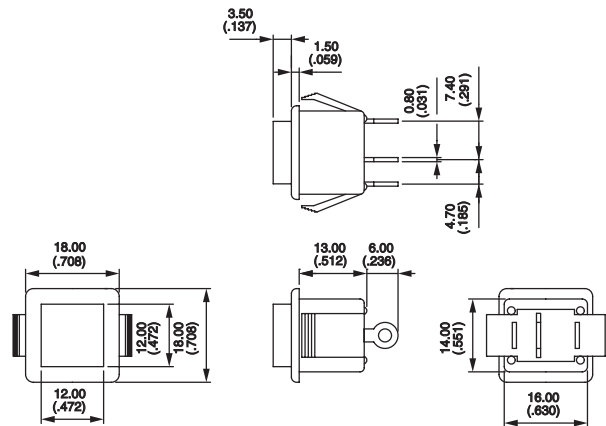

Straight printed circuit terminals

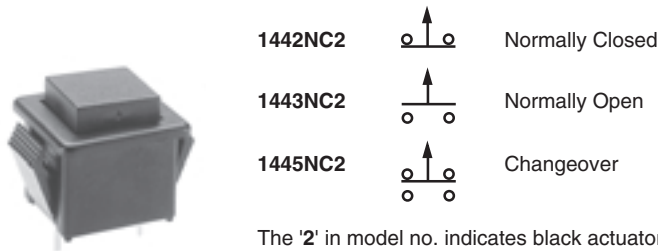

The '2' in model no. indicates black actuator. Substitute '3' for green, '6' for red or '7' for ivory, if desired.

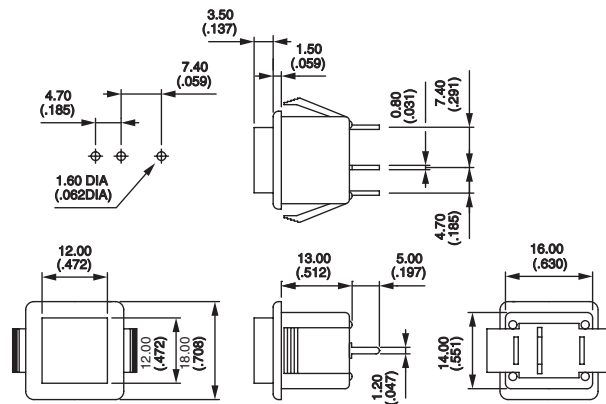

CROSS SECTION

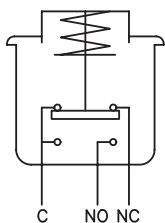

TERMINALS

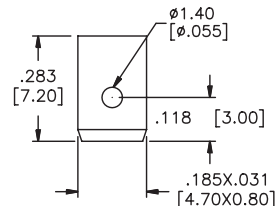
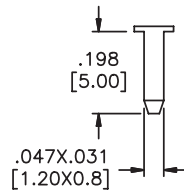
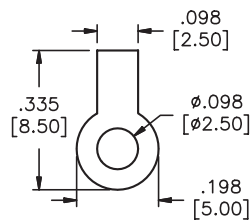

PANEL CUT-OUT

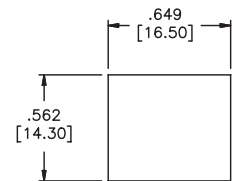

SOLDER LUG

PRINTED CIRCUIT

QUICK-CONNECT
 .185"X.031" (4.7X0.8mm)

SPECIFICATIONS SUBJECT TO CHANGE WITHOUT NOTICE

C

AV SERIES PUSHBUTTON SWITCHES

All AV Series models are rugged, durable, cosmetically attractive and feature:

- Minimum clearance between actuator and bushing, to prevent willful damage by means of insertion of foreign parts or matter.
- Protection against crushing of contacts and switch mechanism.
- Front panel sealing to IEC specification IP54 with optional sealing to IP65 (closest NEMA equivalents are 3S and 6&6P respectively).



SPECIFICATIONS SUBJECT TO CHANGE WITHOUT NOTICE.

The AV Series consists of 3 categories of pushbutton switches designated **Anti-Vandal**, **Security** and **Snap-Action Security**. The distinctive features are:

Anti-Vandal - Highest impact resistance provided by a knurled back nut or mechanical stop and added ruggedness provided by a stainless steel actuator and bushing. The 19mm models meet IK08 which specifies the switch must withstand a hammer blow to the actuator with a striking energy of 6 joules, while the 22mm models meet IK10 which specifies the switch must similarly withstand 20 joules of energy (see table on next page). In both of these cases, no resulting damage is permissible.

Security - High impact resistance and ruggedness with a large variety of options, including actuator shapes, electrical functions, connections, finish and marking options.

Snap-Action Security - High impact resistance and ruggedness. All of these models feature tactile response and optional illumination and marking.

AV SERIES PUSHBUTTON SWITCHES

EXPLANATION OF DEGREES OF PROTECTION (IP AND IK CODES)

IP... defines the degree of protection provided by the enclosures of electric appliances according to IEC529, DIN 40050 and NFC 20-010. Note - the closest NEMA conversions for IP54 and IP65 are 3S and 6&6P, respectively, however they should not be considered equivalent as the NEMA standards test for environmental conditions while the IEC specifications do not.

IK... defines the degree of protection provided by the enclosures of electric appliances against external mechanical impacts according to EN 50102 (NFC 20-015).

The degree of protection is indicated by 2 letters and 3 numbers. The tables list the degree of protection for the 3 numbers.



Example:

IP659— mechanical protection
(optional)
protection against water
protection against dust

SPECIFICATIONS SUBJECT TO CHANGE WITHOUT NOTICE.

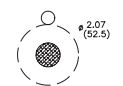
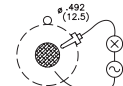
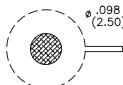
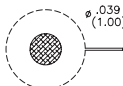
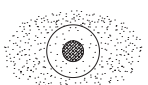
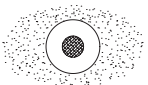
C

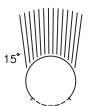
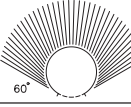
1st number: Protection against entry of solid objects	
IP	Degree of protection
0	Non-protected
1	Protected against solid objects 1.968" (50mm) and greater 
2	Protected against solid objects .492" (12.5mm) and greater 
3	Protected against solid objects .098" (2.5mm) and greater 
4	Protected against solid objects .039" (1mm) and greater 
5	Dust protected (no harmful ingress) 
6	Dust-tight (no ingress) 

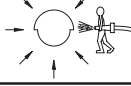
2nd number: Protection against liquids	
IP	Degree of protection
0	Non-protected
1	Protected against vertically falling water drops 
2	Protected against vertically falling water drops when enclosure is tilted up to 15° 
3	Protected against water sprayed vertically at an angle of up to 60° 
4	Protected against splashing water 
5	Protected against water jets from any direction 

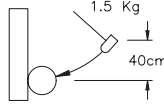
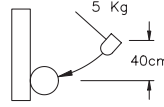
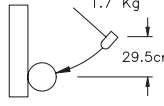
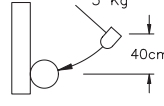
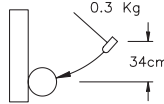
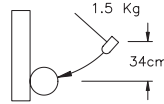
3rd number Protection against external mechanical impacts				
	.748" (19mm) dia. models		.866" (22mm) dia. models	
Degree of protection according to NFC 20-010 (Oct. 86) Hammer radius 50 mm		IP..7 striking energy 6 joules (6 Nm)		IP..9 striking energy 20 joules (20 Nm)
Degree of protection according to EN 50102 (June 95) (NFC 20-015)		IK08 striking energy 5 joules (5Nm) Hammer rad. 25mm		IK10 striking energy 20 joules (20Nm) Hammer rad. 50mm
Impacts on actuator according to CECC 96000 Hammer radius 10 mm		10 strokes striking energy 1 joule 1 Nm		10 strokes striking energy 5 joules 5 Nm

AV SERIES PUSHBUTTON SWITCHES

AV Series switches are listed below by category;
Anti-Vandal, Security and Snap-action Security.

To assist in locating the correct switch for your application, ratings, electrical configuration and mounting bushing diameter are shown. Many special features may be found by reviewing the pages in this section.

C

CATEGORY	RESISTIVE RATINGS & MISCELLANEOUS	ELECTRICAL . CONFIGURATION	SIZE (mm)	PAGE
Anti-Vandal	2 A 48 VDC	SPST NO Momentary	19	C97
	2 A 48 VDC	SPST NO Momentary	22	C98
Security	<i>New!</i> 100-400 mA 48 VDC	SPST NO Momentary	16	C99
	1 A 30 V	SPST NC/NO Momentary	19	C100
	<i>New!</i> 2 A 48 VDC 2 A 48 VDC	SPST NO Momentary SPST NO Momentary	19 22	C101 C102
	3 A 125 VAC, 2 A 250 VAC, & 2.5 A 24 VDC	SPST NC Momentary	22	C103
	3 A 120 VAC or 28 VDC, 1.5 A 250 VAC & Dry Circuit	SPST NO Momentary	19	C104
	3 A 120 VAC or 28 VDC, 1.4 A 250 VAC & Dry Circuit	SPST ON-OFF Alternate action & NO Momentary	19	C105
	<i>New!</i> Large Actuators: 5 A 250 VAC 5 A 250 VAC	SPDT NC/NO Momentary SPDT NC/NO Momentary	22 24	C106 C107
	<i>New!</i> Mushroom Head Actuator: 5 A 250 VAC	SPDT NC/NO Momentary	22	C108
	6 A 125 VAC, 3 A 250 VAC or 24 VDC	DPDT ON-ON alternate action	22	C109
	6 A 125 VAC, 3 A 250 VAC, 7 A 30 VDC & Dry Circuit	SPDT & DPDT NC/NO Momentary	19	C110
	6 A 125 VAC, 3 A 250 VAC, 7 A 30 VDC & Dry Circuit	SPDT NC/NO Momentary	19	C111
	<i>New!</i> Options for Security pushbutton switches			C112
Snap-action Security	<i>New!</i> LED illumination; 50 mA 24 VDC	SPST NO Mom.	19	C113
	<i>New!</i> Options for Snap-Action Security pushbutton switches			C114
	<i>New!</i> 6 A 250 VAC, 10 mA 5 VAC	SPDT & DPDT alternate action	22&24	C115

SPECIFICATIONS SUBJECT TO CHANGE WITHOUT NOTICE.

AV SERIES ANTI-VANDAL PUSHBUTTON SWITCHES

.748" (19mm) or .866" (22mm) bushing diameter

SPECIFICATIONS SUBJECT TO CHANGE WITHOUT NOTICE.



SPECIFICATIONS	FEATURES
<p>Contact ratings: 2 A at 48 VDC max. (resistive load)</p> <p>Initial contact resistance: 10 milliohms max. at 1 A, 2 V</p> <p>Insulation resistance: 1000 megohms min. at 500 VDC</p> <p>Dielectric strength: 2000 V rms min. between terminals and frame and between terminals</p> <p>Electrical life: 10,000 cycles min. at full load</p> <p>Mechanical life: 1,000,000 cycles min.</p> <p>Operating temperature range: -20°C to +55°C</p> <p>Panel thickness: .039" (1mm) to .433" (11mm)</p>	<ul style="list-style-type: none"> ● Single pole NO momentary action. ● Standard - panel sealing protection per IP54. ● Optional - panel sealing protection per IP65. ● Extremely rugged and durable.
	MATERIALS
	<p>Contacts & terminals: Silver plated brass</p> <p>Bushing & Actuator: Stainless steel</p> <p>Case: PBT Hex. Mounting Nut: Nickel plated brass</p>

ORDER FORMAT: For complete model no., fill in empty boxes with selected options shown below. Example of complete model no. - **AV191003C940N**

Series	Bush./Act. Config.	Body Style	Function	Cont. Matl.	Term. Type	Bush./Act. Matl.	Sealing Matl.
AV	[]	100	3	C	[]	40	[]
	09 19 9D				9 2		N T

19mm Bushing/Actuator configurations **Screw terminals (9)** **Solder lug/quick-connect terminals (2)**

9D flat Act. w/flush mount Bush.

19 curved Act. & Bush.

09 flat Act. & curved Bush.

EPOXY

<p>AV091003C940N (Model shown)</p>	<p>N - no sealing - meets IP54 (std'd)</p>	<p>For 09 & 19 Bush/Act</p> <p>For 9D Bush/Act</p>	<p>Complete model no. examples:</p> <p>Flat actuator 09: Screw terminals AV091003C940N Solder lug/quick-connect terminals AV091003C240N</p> <p>Curved actuator 19: Screw terminals AV191003C940N Solder lug/quick-connect terminals AV191003C240N</p> <p>Flat actuator/flush mount 9D: Screw terminals AV9D1003C940N Solder lug/quick-connect terminals AV9D1003C240N</p> <p>STANDARD STOCK MODELS: AV091003C240N AV091003C940N</p>
	<p>T ① Internal seal & ② front panel seals meet IP65</p> <p style="text-align: center;">Sealing</p>	<p>Min. dimensions for matrix mounting: 1.181" (30mm) x 1.181" (30mm).</p> <p style="text-align: center;">Mounting Holes</p>	

AV SERIES ANTI-VANDAL PUSHBUTTON SWITCHES

.748" (19mm) or .866" (22mm) bushing diameter

ORDER FORMAT: For complete model no., fill in empty boxes with selected options shown below. Example of complete model no. - **AV021003C940N**

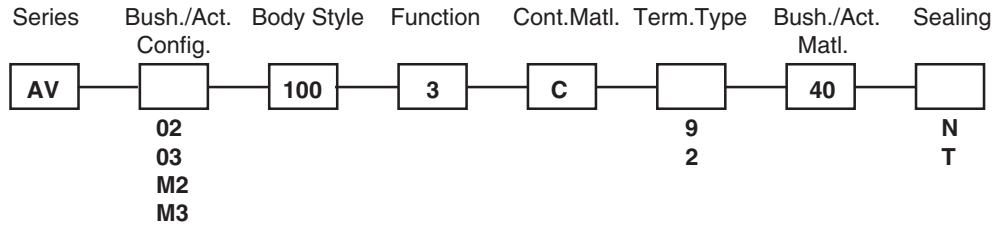

22mm Bushing/Actuator configurations Screw terminals (9) Solder lug/quick-connect terms. (2)

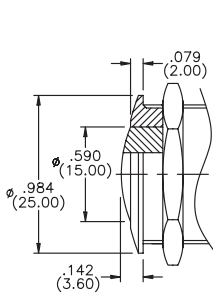

02 curved Act. & Bush.

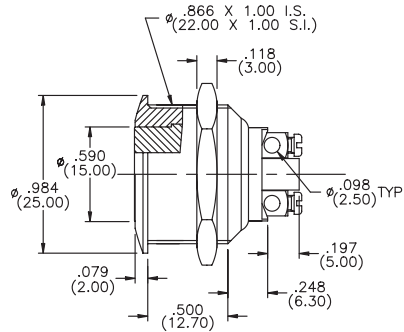

03 flat Act. & curved Bush.

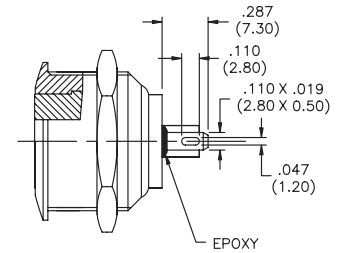

M2 curved Actuator & curved Bushing with 'D' flat on Bushing
or
M3 flat Actuator & curved Bushing with 'D' flat on Bushing

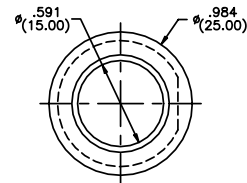

AV021003C940N
(Model shown)



Schematic

N - no sealing - meets IP54 (std'd)

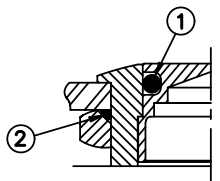

T ① Internal seal & ② front panel seals meet IP65

Sealing

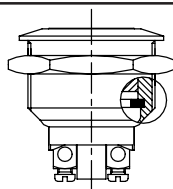

N and T sealing options also feature increased impact resistance provided by an internal ring as shown.

For **02** & **03** Bush/Act

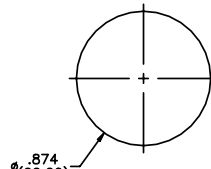

For **M2** & **M3** Bush/Act

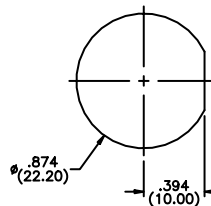

Min. dimensions for matrix mounting: 1.181" (30mm) x 1.181" (30mm).

Mounting Holes

Complete model no. examples:

Flat actuator **03**:
Screw terminals
AV031003C940N
Solder lug/quick-connect terminals
AV031003C240N

Curved actuator **02**:
Screw terminals
AV021003C940N
Solder lug/quick-connect terminals
AV021003C240N

Flatted bushing **M2** & **M3**:
Flat actuator/screw terminals
AVM31003C940N
Curved actuator/screw terminals
AVM21003C940N

STANDARD STOCK MODELS:
AV031003C240N
AV031003C940N
AVM21003C940T

SPECIFICATIONS SUBJECT TO CHANGE WITHOUT NOTICE.

AV SERIES SECURITY PUSHBUTTON SWITCHES

New! .629" (16mm) bushing diameter

SPECIFICATIONS SUBJECT TO CHANGE WITHOUT NOTICE.



SPECIFICATIONS	FEATURES
Contact ratings: 100-400 mA 48VDC max. (resistive Id.) Initial contact resistance: 50 milliohms max. Insulation resistance: 1000 megohms min. at 500 VDC Dielectric strength: 2000 V rms min. between terminals and frame Electrical life: 50,000 cycles min. at 200 mA 48VDC Mechanical life: 1,000,000 cycles min. Operating temperature range: -20°C to +55°C Panel thickness: .039" (1mm) to .236" (6mm)	<ul style="list-style-type: none"> ● Single pole NO momentary action. ● Standard - panel sealing protection per IP54. ● Optional - panel sealing protection per IP65. ● Extremely rugged and durable.
	MATERIALS
	Contacts & terminals: Silver plated brass Bushing & Actuator: Nickel plated brass or stainless steel Case: PBT Hex. Mounting Nut: Nickel plated brass

ORDER FORMAT: For complete model no., fill in empty boxes with selected options shown below. Example of complete model no. - **AV0630C900**

Series	Bush./Act. Config.	Function	Case style	Cont.Matl.	Term.Type	Bush./Act. Matl.	Sealing Matl.
AV	[]	3	0	C	9	[]	[]
	06 16 08					00 40	(NONE) K

16mm	Bushing/Actuator configurations	Screw terminals (9)
	<p style="text-align: center;">08 curved Act. w/chamfer 16 curved Actuator</p>	<p style="text-align: center;">06 flat Act. & curved Bush.</p>

<p>AV0630C900 (Model shown)</p>	<p style="color: red;">(NONE) - no sealing - meets IP54</p> <p>K ① Internal seal & ② front panel seals meet IP65</p>	<p>Min. dimensions for matrix mounting: .944" (24mm) x .944" (24mm).</p> <p style="color: red;">Mounting Hole</p>	<p>Complete model no. examples:</p> <p>Flat actuator 06: Nickel plated brass bushing and actuator 00 AV0630C900</p> <p>Curved actuator 16: Stainless steel bushing and actuator 40 AV1630C940</p> <p>Curved actuator w/chamfer 08: Nickel plated brass bushing and actuator 00, and IP67 sealing K AV0830C900K</p> <p style="color: red;">STANDARD STOCK MODELS: AV0630C900 AV0630C940</p>
<p style="color: red;">Schematic</p>	<p style="color: red;">Sealing</p>		

AV SERIES SECURITY PUSHBUTTON SWITCHES

.748" (19mm) bushing diameter

SPECIFICATIONS

Contact ratings: 1 A at 30 V max. (resistive load)
 10μA at 5 V min.
 Note: current above 100 mA damages the gold plating
Initial contact resistance: 10 milliohms max. at 1 A, 2 V
Insulation resistance: 1000 megohms min. at 500 VDC
Dielectric strength: 2000 V rms min. between terminals and frame
Electrical life: 250,000 cycles min. at full load
Mechanical life: 1,000,000 cycles min.
Operating temperature range: -20°C to +55°C
Panel thickness: .039" (1mm) to .433" (11mm)

FEATURES

- Single pole combined NC/NO momentary action.
- Standard - panel sealing protection per IP54.
- Optional - panel sealing protection per IP65.
- Extremely rugged and durable.

MATERIALS

Contacts & terminals: Gold plated Silver
Bushing & Actuator: Nickel plated brass
Case: PBT **Hex. Mounting Nut:** Nickel plated brass

ORDER FORMAT:

For complete model no., fill in empty boxes with selected options shown below. Example of complete model no. - AV199035D200

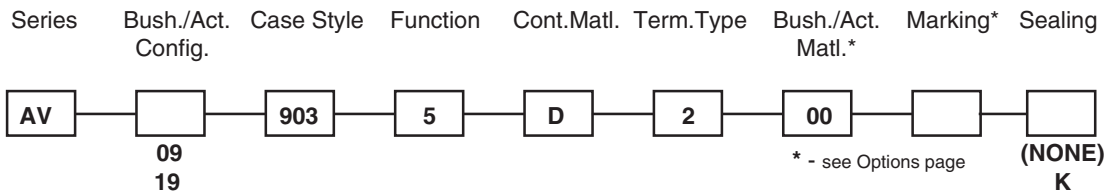

19mm

Bushing/Actuator configurations

Solder lug terminals (2)

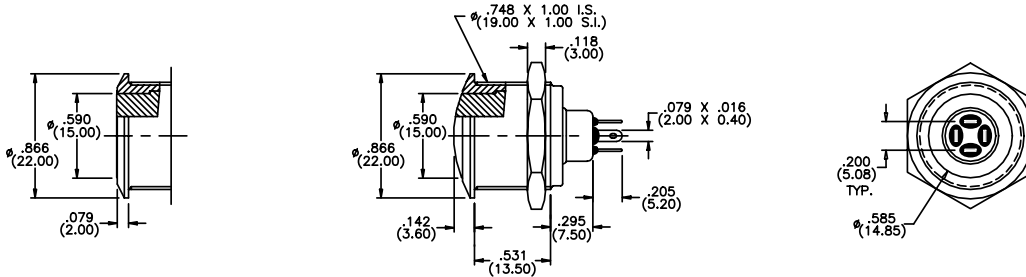

09 flat Act. & curved Bush.

19 curved Act. & Bush.

Rear view of all models



AV199035D200
(Model shown)



Schematic

(NONE) - no sealing - meets IP54

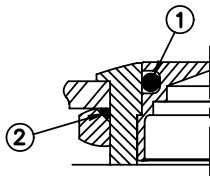

K ① Internal seal & ② front panel seals meet IP65

Sealing

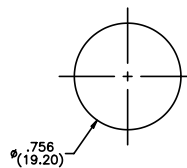

Min. dimensions for matrix mounting: 1.181" (30mm) x 1.181" (30mm).

Mounting Hole

Complete model no. examples:

Flat actuator & curved bushing 09:
AV099035D200

Curved actuator & bushing 19:
AV199035D200

STANDARD STOCK MODELS:
AV099035D200
AV199035D200

SPECIFICATIONS SUBJECT TO CHANGE WITHOUT NOTICE.

AV SERIES SECURITY PUSHBUTTON SWITCHES

New! .748" (19mm) or .866" (22mm) bushing diameter



SPECIFICATIONS SUBJECT TO CHANGE WITHOUT NOTICE.

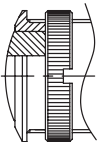
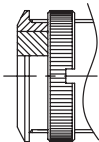
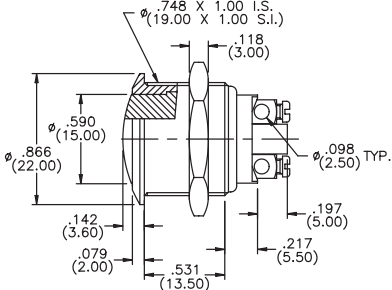
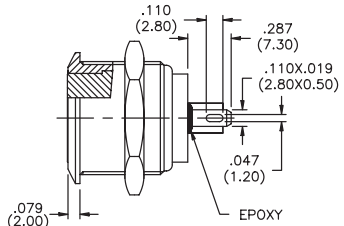

SPECIFICATIONS	FEATURES
<p>Contact ratings: 2 A at 48 VDC max. (resistive load)</p> <p>Initial contact resistance: 10 milliohms max. at 1 A, 2 V</p> <p>Insulation resistance: 1000 megohms min. at 500 VDC</p> <p>Dielectric strength: 2000 V rms min. between terminals and frame and between terminals</p> <p>Electrical life: 10,000 cycles min. at full load</p> <p>Mechanical life: 1,000,000 cycles min.</p> <p>Operating temperature range: -20°C to +55°C</p> <p>Panel thickness: .039" (1mm) to .433" (11mm)</p>	<ul style="list-style-type: none"> ● Single pole NO momentary action. ● Standard - panel sealing protection per IP54. ● Optional - panel sealing protection per IP65. ● Extremely rugged and durable.
	MATERIALS
	<p>Contacts & terminals: Silver plated brass</p> <p>Bushing & Actuator: Nickel plated brass</p> <p>Case: PBT Hex. Mounting Nut: Nickel plated brass</p>

ORDER FORMAT:	Series	Bush./Act. Config.	Case Style	Function	Cont.Matl.	Term.Type	Bush./Act. Matl.*	Marking*	Sealing
<p>For complete model no., fill in empty boxes with selected options shown below. Example of complete model no. - AV191003C900</p>	AV	<div style="border: 1px solid black; padding: 2px; width: 30px; height: 20px; margin: 0 auto;">09</div> <div style="border: 1px solid black; padding: 2px; width: 30px; height: 20px; margin: 0 auto;">19</div> <div style="border: 1px solid black; padding: 2px; width: 30px; height: 20px; margin: 0 auto;">9P</div> <div style="border: 1px solid black; padding: 2px; width: 30px; height: 20px; margin: 0 auto;">9B</div>	100	3	C	<div style="border: 1px solid black; padding: 2px; width: 30px; height: 20px; margin: 0 auto;">9</div> <div style="border: 1px solid black; padding: 2px; width: 30px; height: 20px; margin: 0 auto;">2</div>	<div style="border: 1px solid black; padding: 2px; width: 30px; height: 20px; margin: 0 auto;">00</div>	<div style="border: 1px solid black; padding: 2px; width: 30px; height: 20px; margin: 0 auto;"> </div>	<div style="border: 1px solid black; padding: 2px; width: 30px; height: 20px; margin: 0 auto;">(NONE)</div> <div style="border: 1px solid black; padding: 2px; width: 30px; height: 20px; margin: 0 auto;">K</div>
							* - see Options page		

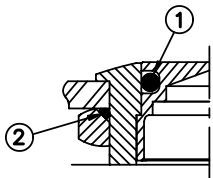
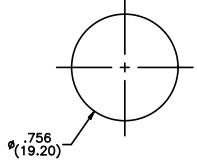
19mm Bushing/Actuator configurations	Screw terminals (9)	Solder lug/quick-connect terminals (2)
<p>With knurled nut for matrix mtg. .984" (25mm) x .984" (25mm)</p> <p>Wrench available p/n U1929, order separately</p>		
 <p>9B curved Act. w/knurled nut</p>	 <p>9P flat Act. w/knurled nut</p>	 <p>19 curved Actuator</p>
		 <p>09 flat Actuator</p>

 <p>AV191003C900 (Model shown)</p>	<p>(NONE) - no sealing - meets IP54</p>  <p>K ① Internal seal & ② front panel seals meet IP65</p>	 <p>Min. dimensions for matrix mounting: 1.181" (30mm) x 1.181" (30mm).</p>	<p>Complete model no. examples:</p> <p>Flat actuator 09: Screw terminals AV091003C900 Solder lug/quick-connect terminals AV091003C200</p> <p>Curved actuator 19: Screw terminals AV191003C900 Solder lug/quick-connect terminals AV191003C200</p> <p>Flat act. w/knurled nut 9P: Screw terminals AV9P1003C900 Solder lug/quick-connect terminals AV9P1003C200</p> <p>STANDARD STOCK MODELS: AV091003C200 AV091003C900 AV091003C900K AV191003C900 AV191003C900K</p>
 <p>Schematic</p>	<p>Sealing</p>	<p>Mounting Hole</p>	

AV SERIES SECURITY PUSHBUTTON SWITCHES

New! .748" (19mm) or .866" (22mm) bushing diameter

C

ORDER FORMAT: For complete model no., fill in empty boxes with select-ed options shown below.
Example of complete model no. - **AV021003C900**

Series	Bush./Act. Config.	Case Style	Function	Cont.Matl.	Term.Type	Bush./Act. Matl.*	Marking*	Sealing
AV		100	3	C		00		
	02 03 M2 M3				9 2	* - see Options page		(NONE) K

22mm Bushing/Actuator configurations Screw terminals (9) Solder lug/quick-connect terms. (2)

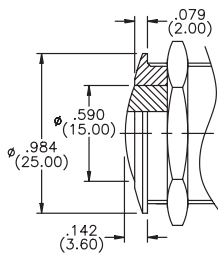

02 curved Act. & Bush.

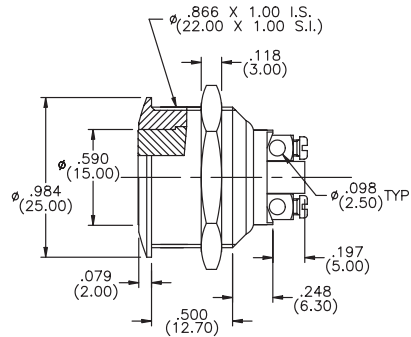

03 flat Act. & curved Bush.

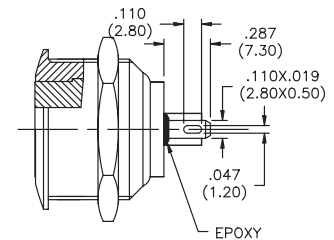

M2 curved Actuator & curved Bushing with 'D' flat on Bushing
or
M3 flat Actuator & curved Bushing with 'D' flat on Bushing

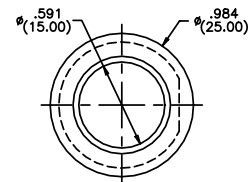

AV021003C900
(Model shown)



Schematic

(NONE) - no sealing - meets IP54

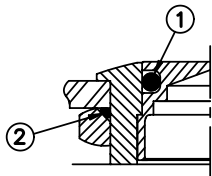

K ① Internal seal & ② front panel seals meet IP65

Sealing

For **02 & 03** Bush/Act

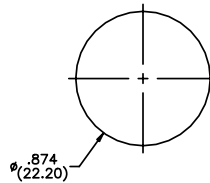

For **M2 & M3** Bush/Act

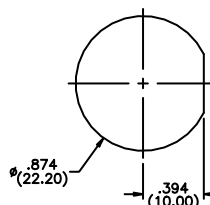

Min. dimensions for matrix mounting: 1.181" (30mm) x 1.181" (30mm).

Mounting Holes

Complete model no. examples:

Flat actuator **03**:
Screw terminals
AV031003C900
Solder lug/quick-connect terminals
AV031003C200

Curved actuator **02**:
Screw terminals
AV021003C900
Solder lug/quick-connect terminals
AV021003C200

Flatted bushing **M2 & M3**:
Flat actuator/screw terminals
AVM31003C900
Curved actuator/screw terminals
AVM21003C200

STANDARD STOCK MODELS:
AV021003C900
AV031003C200
AV031003C900

AV SERIES SECURITY PUSHBUTTON SWITCHES





.866" (22mm) bushing diameter

SPECIFICATIONS SUBJECT TO CHANGE WITHOUT NOTICE.

C

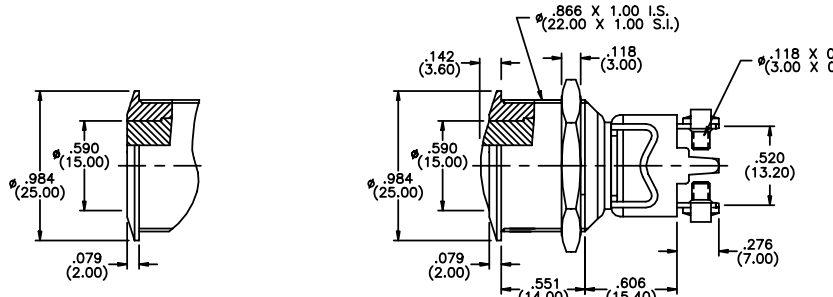
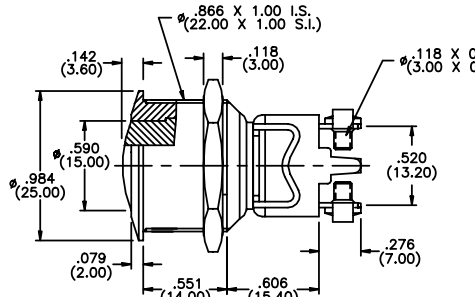
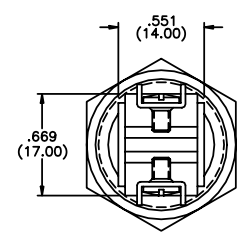
SPECIFICATIONS	FEATURES
<p>Contact ratings: Max. resistive loads; 3 A 125VAC 2 A 250VAC & 2.5 A 24VDC</p> <p>Initial contact resistance: 10 milliohms max. at 1 A, 2 V</p> <p>Insulation resistance: 1000 megohms min. at 500 VDC</p> <p>Dielectric strength: 2000 V rms min. between terminals and frame and between terminals</p> <p>Electrical life: 250,000 cycles min. at full load</p> <p>Mechanical life: 100,000 cycles at 0.3 A 24V, 10,000 cycles at full load</p> <p>Operating temperature range: -20°C to +55°C</p> <p>Panel thickness: .039" (1mm) to .433" (11mm)</p>	<ul style="list-style-type: none"> ● Single pole NC momentary action. ● Standard - panel sealing protection per IP54. ● Optional - panel sealing protection per IP65. ● Extremely rugged and durable.
	MATERIALS
	<p>Contacts & terminals: Silver plated copper</p> <p>Bushing & Actuator: Nickel plated brass</p> <p>Case: PBT Hex. Mounting Nut: Nickel plated brass</p>

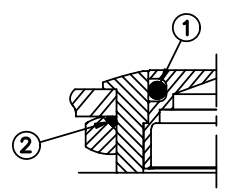
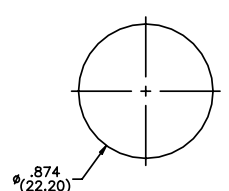
ORDER FORMAT:	Series	Bush./Act. Config.	Case Style	Function	Cont.Matl.	Term.Type	Bush./Act. Matl.*	Marking*	Sealing
<p>For complete model no., fill in empty boxes with selected options shown below. Example of complete model no. - AV021202C000</p>	AV	<div style="border: 1px solid black; width: 30px; height: 30px; margin: 0 auto;"></div> <p style="text-align: center; font-size: 0.8em;">02 03</p>	120	2	C	0	00	<div style="border: 1px solid black; width: 30px; height: 30px; margin: 0 auto;"></div>	<div style="border: 1px solid black; width: 30px; height: 30px; margin: 0 auto;"></div> <p style="text-align: center; font-size: 0.8em;">(NONE) K</p>
							* - see Options page		

22mm	Bushing/Actuator configurations	Straight screw terminals w/clamp (0)	
	 <p style="text-align: center;">03 flat Act. & curved Bush.</p>	 <p style="text-align: center;">02 curved Act. & Bush.</p>	
		 <p style="text-align: center;">Rear view of all models</p>	
 <p style="text-align: center;">AV021202C000 (Model shown)</p>	<p style="text-align: center;">(NONE) - no sealing - meets IP54</p>  <p style="text-align: center;">K ① Internal seal & ② front panel seals meet IP65</p>	 <p style="text-align: center;">Min. dimensions for matrix mounting: 1.181" (30mm) x 1.181" (30mm).</p>	<p>Complete model no. examples:</p> <p>Flat actuator & curved bushing 03: AV031202C000</p> <p>Curved actuator & bushing 02: AV021202C000</p> <p style="color: red; font-weight: bold; text-align: center;">STANDARD STOCK MODELS: AV021202C000 AV031202C000</p>
 <p style="text-align: center; color: red; font-weight: bold;">Schematic</p>	<p style="color: red; font-weight: bold;">Sealing</p>	<p style="color: red; font-weight: bold;">Mounting Hole</p>	

AV SERIES SECURITY PUSHBUTTON SWITCHES

.748" (19mm) bushing diameter

SPECIFICATIONS

Contact ratings: Max. resistive loads: **Q** - 3 A 120 VAC (and life) or 28 VDC, 1.5 A 250 VAC - 10,000 cycles min. Also 1 A 120 VAC or 28 VDC, 0.5 A 250 VAC - 250,000 cycles min. **B** - 0.4 Volt-Amps max at 20 V max. - 250,000 cycles min.

Initial contact resistance: 10 mΩ max. at 3 V, 0.1 A

Insulation resistance: 10,000 megohms min.

Dielectric strength: 1000 V rms min.

Operating temperature range: -30°C to +85°C

For additional specifications: See 300 Series switches

FEATURES

- **.755" (19 mm) dia. models.**
- **Single pole NO momentary action.**
- **Standard - sealing protection per IP54.**
- **Optional - sealing protection per IP65.**
- **Extremely rugged and durable.**

MATERIALS

Contacts: **Q** - Coin silver for power & UL models. **B** - Gold over nickel over brass for dry circuit models.

Bushing & Actuator: Nickel plated brass (std'd)

Case: Diallyl Phthalate **Hex. Mounting Nut:** Nickel plated brass

ORDER FORMAT:

For complete model no., fill in boxes with selected options shown below. Example of complete model no. -

AV19301ZQEKUL

Series	Bush./Act. Config.	Body Style	Term. Type	Cont. Matl.	Term. Seal	Sealing	Agency Recognition
AV	09 19 29 39 49	301 305	Z	B Q	E	(NONE) K	(NONE) U L
For mushroom cap (49) only: Add color code at end of above model number - 0 for natural or 6 for red (consult factory for other colors).							

19mm

Bushing/Actuator configuration

Solder lug terminals - (Z)

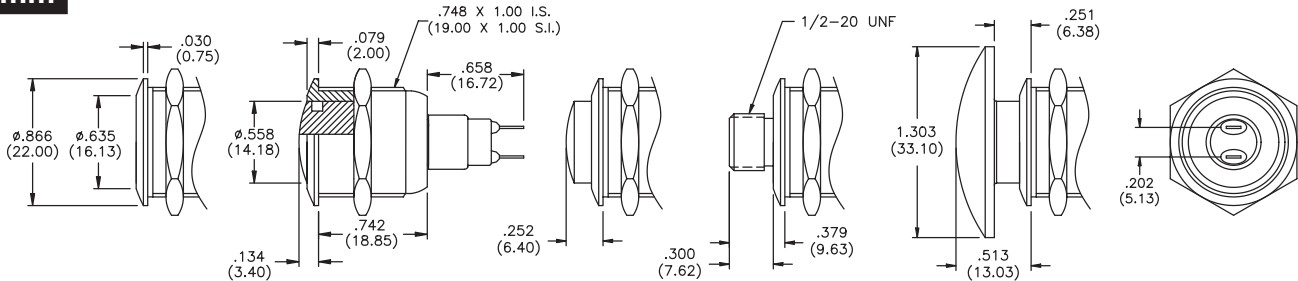

09 flat Act. & curved Bushing

19 curved Act. & Bushing (standard)

29 extended Act. & curved bushing

39 threaded Act. & curved bushing

49 th'd Act. with mushroom cap & curved bushing

Rear view all models



AV19301ZQEUL
(Model shown)



Schematic

Blank - no sealing - meets IP54 (std'd)

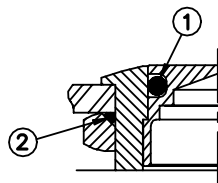

K ① Internal seal & ② front panel seals meet IP65

Sealing

Min. dimensions for matrix mounting: .984" (25mm) x .984" (25mm).

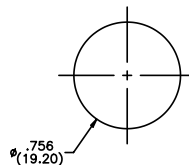

Mounting Hole

Notes to Order Format:
301 models have .020" (0.5mm) overtravel and .110" (2.79mm) total travel.

305 models have .080" (2.03mm) overtravel and .110" (2.79mm) total travel.

UL option available only with Q option. UL rating: 1 A 125 VAC or 0.5 A 250 VAC (75% power factor). UL file E66367.

E option is epoxy terminal seal - standard.

SPECIFICATIONS SUBJECT TO CHANGE WITHOUT NOTICE.

AV SERIES SECURITY PUSHBUTTON SWITCHES

.748" (19mm) bushing diameter

SPECIFICATIONS SUBJECT TO CHANGE WITHOUT NOTICE.



SPECIFICATIONS	FEATURES
<p>Contact ratings: Max. resistive loads: Q - 3 A 120 VAC (and life) or 28 VDC, 1.5 A 250 VAC - 10,000 cycles min. Also 1 A 120 VAC or 28 VDC, 0.5 A 250 VAC - 250,000 cycles min. B - 0.4 Volt-Amps max at 20 V max. - 250,000 cycles min.</p> <p>Initial contact resistance: 10 mΩ max. at 3 V, 0.1 A</p> <p>Insulation resistance: 10,000 megohms min.</p> <p>Dielectric strength: 1000 V rms min.</p> <p>Operating temperature range: -30°C to +85°C</p> <p>For additional specifications: See 400 Series switches</p>	<ul style="list-style-type: none"> ● .755" (19 mm) dia. models. ● Single pole ON-OFF alternate & momentary actions. ● Standard - sealing protection per IP54. ● Optional - sealing protection per IP65. ● Extremely rugged and durable.
	<p>MATERIALS</p> <p>Contacts: Q - Coin silver for power & UL models. B - Gold over nickel over brass for dry circuit models.</p> <p>Bushing & Actuator: Nickel plated brass (std'd)</p> <p>Case: Diallyl Phthalate Hex. Mounting Nut: Nickel plated brass</p>

	Series	Bush./Act. Config.	Body Style	Term. Type	Cont. Matl.	Term. Seal	Sealing	Agency Recognition
<p>ORDER FORMAT: For complete model no., fill in boxes with selected options shown below. Example of complete model no. - AV19401ZQEKUL</p>	AV	<div style="border: 1px solid black; width: 20px; height: 20px; margin: 0 auto;"></div> <p style="text-align: center; margin: 0;">09</p> <p style="text-align: center; margin: 0;">19</p> <p style="text-align: center; margin: 0;">29</p> <p style="text-align: center; margin: 0;">39</p> <p style="text-align: center; margin: 0;">49</p>	<div style="border: 1px solid black; width: 20px; height: 20px; margin: 0 auto;"></div> <p style="text-align: center; margin: 0;">401</p> <p style="text-align: center; margin: 0;">402</p>	Z	<div style="border: 1px solid black; width: 20px; height: 20px; margin: 0 auto;"></div> <p style="text-align: center; margin: 0;">B</p> <p style="text-align: center; margin: 0;">Q</p>	E	<div style="border: 1px solid black; width: 20px; height: 20px; margin: 0 auto;"></div> <p style="text-align: center; margin: 0;">(NONE)</p> <p style="text-align: center; margin: 0;">K</p>	<div style="border: 1px solid black; width: 20px; height: 20px; margin: 0 auto;"></div> <p style="text-align: center; margin: 0;">(NONE)</p> <p style="text-align: center; margin: 0;">UL</p>
	<p>For mushroom cap (49) only: Add color code at end of above model number - 0 for natural or 6 for red (consult factory for other colors).</p>							

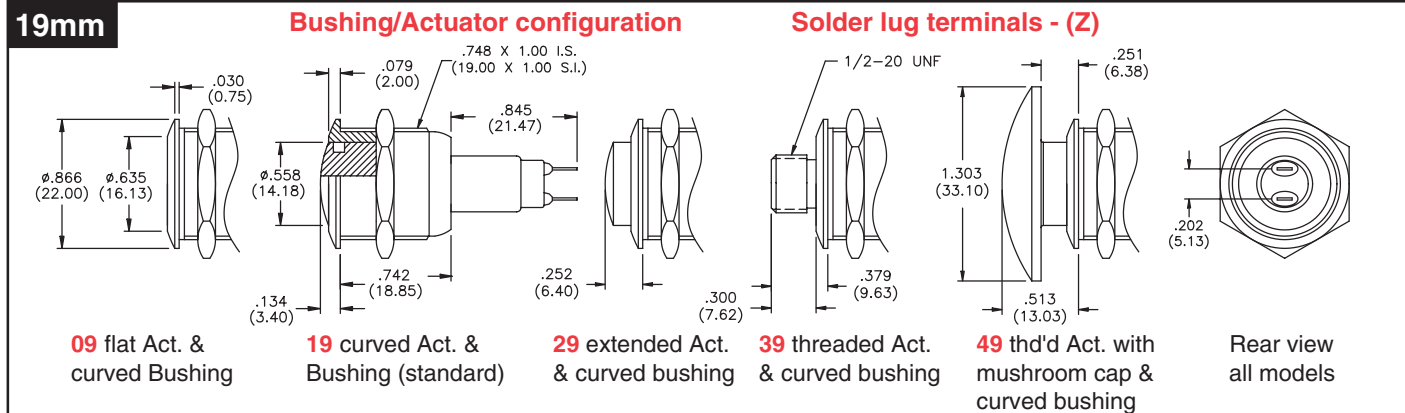

<p>AV19401ZQEUL (Model shown)</p>	<p>Blank - no sealing - meets IP54(std'd)</p>	<p>Min. dimensions for matrix mounting: .984" (25mm) x .984" (25mm).</p>	<p>Notes to Order Format:</p> <p>401 is alternate action. 402 is momentary action.</p> <p>401 models have .026" (0.7mm) to contact closure, .106" (2.7mm) travel to activate switch and .137" (3.5mm) total travel.</p> <p>UL option available only with Q option. UL rating: 1 A 125 VAC or 0.5 A 250 VAC (75% power factor). UL file E66367.</p> <p>E option is epoxy terminal seal - standard.</p>
<p>Schematic</p>	<p>K ① Internal seal & ② front panel seals meet IP65</p> <p style="text-align: center;">Sealing</p>	<p>Mounting Hole</p>	

AV SERIES SECURITY PUSHBUTTON SWITCHES WITH LARGE ACTUATOR

New!

SPECIFICATIONS

Contact ratings: 5 A at 250VAC
Initial contact resistance: 100 milliohms max.
Insulation resistance: 1000 megohms min. at 500 VDC
Dielectric strength: 2000 V rms min. between terminals and frame
Electrical life: 1,000,000 cycles min. at 1A 250VAC or 100,000 cycles at full load
Mechanical life: 3,000,000 cycles min.
Operating temperature range: -20°C to +55°C
Panel thickness: .039" (1mm) to .236" (6mm)

FEATURES

- .866" (22 mm) dia. or .944" (24mm) dia. bushing.
- Single pole combined NC/NO momentary action.
- Standard - panel sealing protection per IP65.
- Extremely rugged and durable.

MATERIALS

Contacts: Silver/nickel alloy
Bushing & Actuator: Stainless steel
Case: Polyester, glass filled **Hex. Mtg. Nut:** Nickel plated brass

ORDER FORMAT: For complete model no., fill in empty boxes with selected options shown below. Example of complete model no. - **AV22LP402**

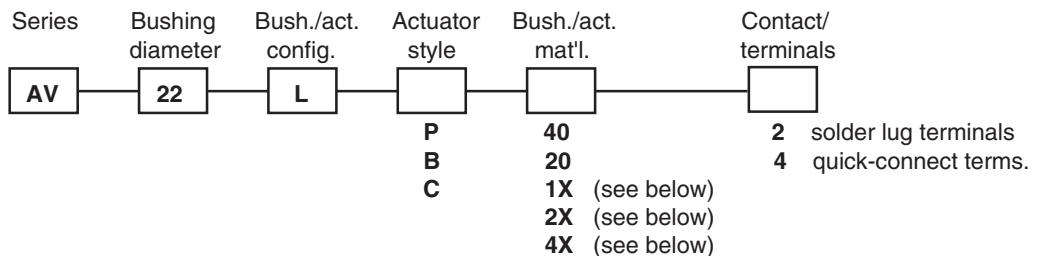

22mm

Bushing/Actuator configurations

Solder lug (2) or quick-connect terminals (4)

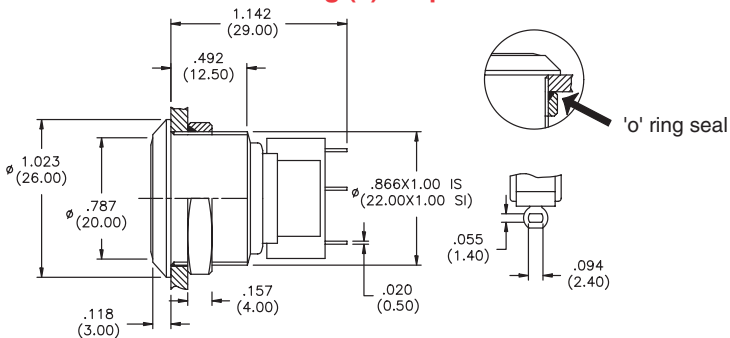
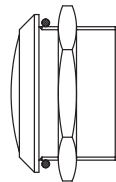
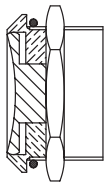

C recessed Actuator **B** curved Actuator

P flat Actuator



AV22LP402
(Model shown)

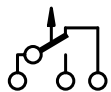

Schematic

40 Stainless steel bushing and actuator material is standard.
Other options -
20 Chrome plated brass bushing and actuator material.
Colored actuators* -
1X Black chrome plated brass bushing with anodized aluminum actuator.
2X Chrome plated brass bushing with anodized aluminum actuator.
4X Stainless steel bushing with anodized aluminum actuator.

* Replace **X** in above option numbers for color: **2** black, **3** pale green, **5** gold yellow or **6** red

Bushing/actuator Mat'l.'s

0- ring front panel seal meets IP67
Sealing (standard)

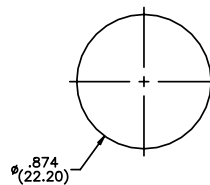

Min. dimensions for matrix mounting:
 1.181" (30mm) x 1.181" (30mm).

Mounting Hole

Complete model no. examples:
Flat actuator P:
 Solder lug terminals **AV22LP402**
 Solder lug terms., black bushing and red actuator **AV22LP164**
Curved actuator B:
 Solder lug terminals **AV22LB402**
 Quick-connect terminals **AV22LB404**
Recessed actuator C:
 Solder lug terminals **AV22LC402**
 Quick-connect terminals **AV22LC404**

STANDARD STOCK MODELS:
AV22LC164
AV22LP402

SPECIFICATIONS SUBJECT TO CHANGE WITHOUT NOTICE.

AV SERIES SECURITY PUSHBUTTON SWITCHES WITH LARGE ACTUATOR

New!

ORDER FORMAT: For complete model no., fill in empty boxes with selected options shown below. Example of complete model no. - **AV24LP402**

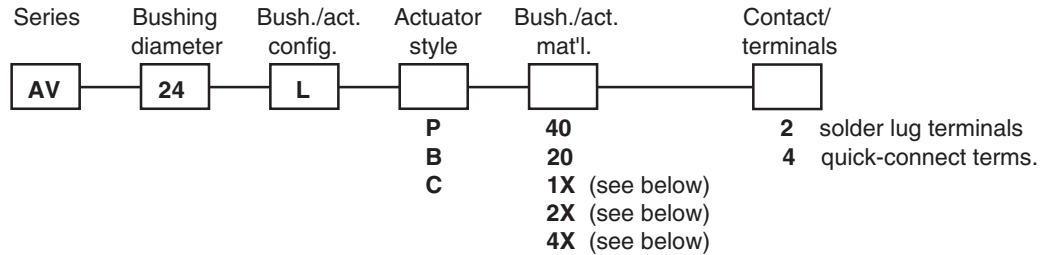

24mm

Bushing/Actuator configurations

Solder lug (2) or quick-connect terminals (4)

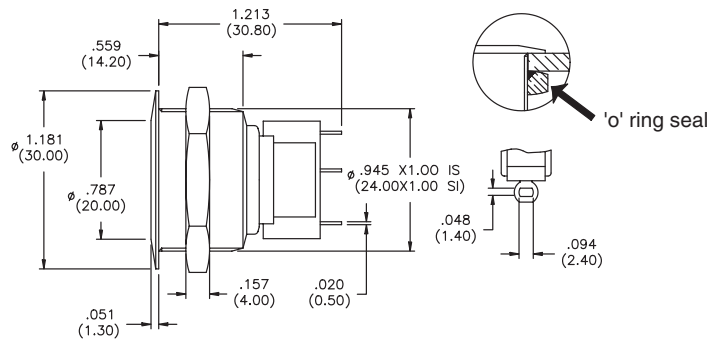
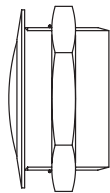
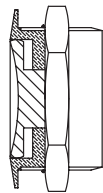

C recessed Actuator **B** curved Actuator

P flat Actuator



**AV24LP402
(Model shown)**

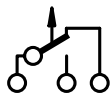

Schematic

O- ring front panel seal meets IP67
Sealing (standard)

- 40** Stainless steel bushing and actuator material is standard.
- Other options -**
- 20** Chrome plated brass bushing and actuator material.
- Colored actuators* -**
- 1X** Black chrome plated brass bushing with anodized aluminum actuator.
- 2X** Chrome plated brass bushing with anodized aluminum actuator.
- 4X** Stainless steel bushing with anodized aluminum actuator.

* Replace **X** in above option numbers for color: **2** black, **3** pale green, **5** gold yellow or **6** red

Bushing/actuator Material

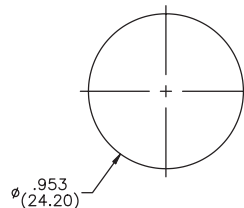

Min. dimensions for matrix mounting:
1.299" (33mm) x 1.299" (33mm).

Mounting Hole

Complete model no. examples:

Flat actuator **P**:
Solder lug terminals
AV24LP402
Solder lug terms., black bushing and red actuator
AV24LP164

Curved actuator **B**:
Solder lug terminals
AV24LB402
Quick-connect terminals
AV24LB404

Recessed actuator **C**:
Solder lug terminals
AV24LC402
Quick-connect terminals
AV24LC404

SPECIFICATIONS SUBJECT TO CHANGE WITHOUT NOTICE.

C

AV SERIES SECURITY PUSHBUTTON SWITCHES

New! WITH MUSHROOM HEAD ACTUATOR

C

SPECIFICATIONS

Contact ratings: 5 A at 250VAC
Initial contact resistance: 100 milliohms max.
Insulation resistance: 1000 megohms min. at 500 VDC
Dielectric strength: 2000 V rms min. between terminals and frame
Electrical life: 1,000,000 cycles min. at 1A 250VAC or 100,000 cycles at full load
Mechanical life: 1,000,000 cycles min.
Operating temperature range: -20°C to +55°C
Panel thickness: .039" (1mm) to .236" (6mm)

FEATURES

- .866" (22 mm) diameter bushing.
- Single pole combined NC/NO momentary action.
- Standard - panel sealing protection per IP65.
- Extremely rugged and durable.

MATERIALS

Contacts: Silver/nickel alloy
Bushing: Nickel plated brass **Actuator:** Anodized aluminum
Case: Polyester, glass filled **Hex. Mtg. Nut:** Nickel plated brass

ORDER FORMAT: For complete model no., fill in empty boxes with selected options shown below. Example of complete model no. - **AV22PNA62**

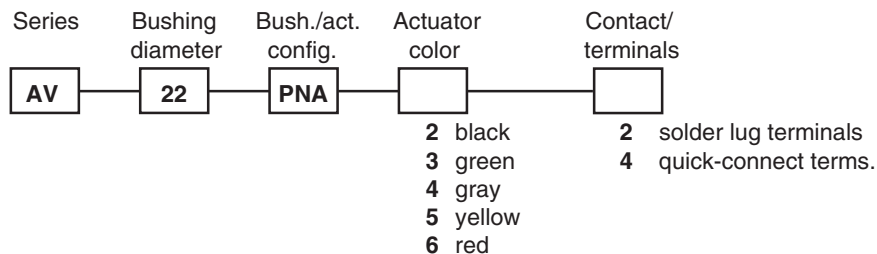

22mm

Bushing/Actuator configuration

Solder lug (2) or quick-connect terminals (4)

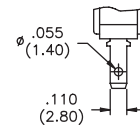
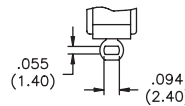
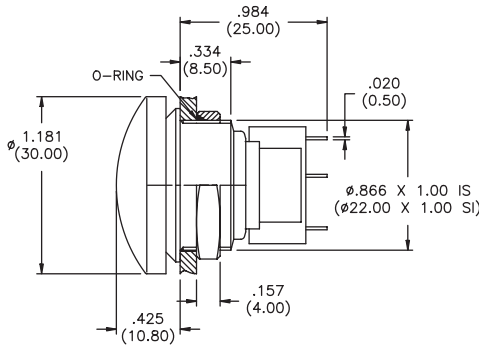

AV22PNA62
(Model shown)

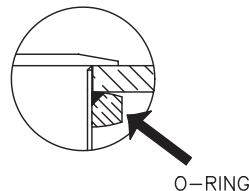

O-ring front panel seal meets IP67

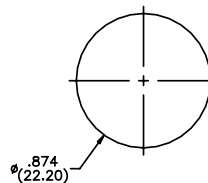

Min. dimensions for matrix mounting:
1.203" (30.5mm) x 1.203" (30.5mm).

Complete model no. examples

Black actuator and solder lug terminals
AV22PNA22

Red actuator and quick-connect terminals
AV22PNA64

STANDARD STOCK MODEL:
AV22PNA62

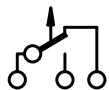

Schematic

Sealing (standard)

Mounting Hole

SPECIFICATIONS SUBJECT TO CHANGE WITHOUT NOTICE.

AV SERIES SECURITY PUSHBUTTON SWITCHES

.866" (22mm) bushing diameter

SPECIFICATIONS SUBJECT TO CHANGE WITHOUT NOTICE.



SPECIFICATIONS	FEATURES
<p>Contact ratings: Max. resistive loads; 6 A 125VAC, 3 A 250VAC & 3 A 24 VDC</p> <p>Initial contact resistance: 10 milliohms max. at 1 A, 2 V</p> <p>Insulation resistance: 1000 megohms min. at 500 VDC</p> <p>Dielectric strength: 3000 V rms min. between terminals and frame</p> <p>Electrical life: 50,000 cycles at 1 A 24V, 10,000 cycles at full load</p> <p>Mechanical life: 100,000 cycles at 0.3 A 24V</p> <p>Operating temperature range: -20°C to +55°C</p> <p>Panel thickness: .039" (1mm) to .433" (11mm)</p>	<ul style="list-style-type: none"> ● Double pole alternate action (ON-ON). ● Standard - panel sealing protection per IP54. ● Optional - panel sealing protection per IP65. ● Extremely rugged and durable.
	MATERIALS
	<p>Contacts: Silver</p> <p>Bushing & Actuator: Nickel plated brass</p> <p>Case: PBT Hex. Mounting Nut: Nickel plated brass</p>

ORDER FORMAT: For complete model no., fill in empty boxes with selected options shown below. Example of complete model no. - **AV044746A200**

Series	Bush./Act. Config.	Case Style	Function	Cont.Matl.	Term.Type	Bush./Act. Matl.*	Marking*	Sealing
AV	04	474	6	A	2	00		(NONE) K

* - see Options page

22mm

Bushing/Actuator configurations

Solder lug/quick-connect terminals (2)

04 curved Act. & Bush.

<p>AV044746A200 (Model shown)</p>	<p style="color: red; font-weight: bold;">(NONE)</p> <p>- no sealing - meets IP54</p> <p style="color: red; font-weight: bold;">K</p> <p>① Internal seal & ② front panel seals meet IP65</p>	<p>Min. dimensions for matrix mounting: 1.181" (30mm) x 1.181" (30mm).</p>	<p style="color: red; font-weight: bold;">STANDARD STOCK MODEL: AV044746A200</p>
<p style="color: red; font-weight: bold;">Schematic</p>	<p style="color: red; font-weight: bold;">Sealing</p>	<p style="color: red; font-weight: bold;">Mounting Hole</p>	

AV SERIES SECURITY PUSHBUTTON SWITCHES

.748" (19mm) bushing diameter

SPECIFICATIONS

Contact ratings: Max. resistive loads: **Q** - 6 A 125 VAC, 3 A 250 VAC or 7 A 30 VDC.
B - 0.4 Volt-Amps max at 20 V max.
Initial contact resistance: 20 mΩ max. at 3 VDC, 0.1 A
Insulation resistance: 200,000 megohms minimum between terminals & case ground.
Dielectric strength: 1500 VAC min. between terminals and case ground.
Electrical life: 60,000 cycles min.
Operating temperature range: -30°C to +85°C
For additional specifications: See 800 Series switches

FEATURES

- .755" (19 mm) dia. models.
- SPDT and DPDT with NO & NC momentary action.
- Standard - sealing protection per IP54.
- Optional - sealing protection per IP65.
- Extremely rugged and durable.

MATERIALS

Contacts: **Q** - Coin silver for power & UL models. **B** - Gold over nickel over brass for dry circuit models.
Bushing & Actuator: Nickel plated brass (std'd)
Case: Diallyl Phthalate **Hex. Mounting Nut:** Nickel plated brass

ORDER FORMAT:

For complete model no., fill in boxes with selected options shown below.
 Example of complete model no. -
AV19810KMZQKUL

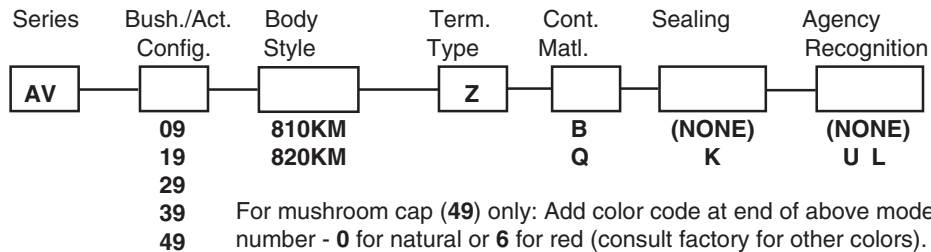

19mm

Bushing/Actuator configuration

Solder lug terminals - (Z)

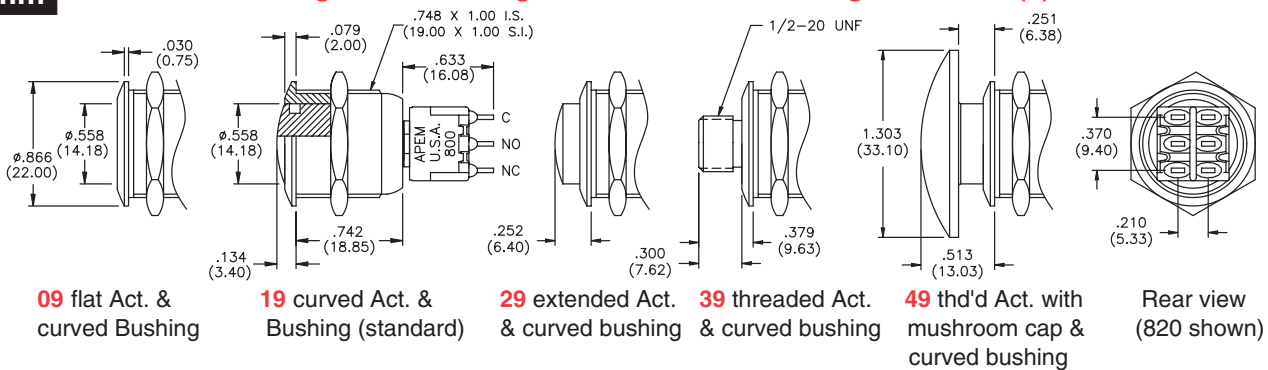

AV19820KMZQUL
(Model shown)

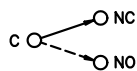

Schematic

Blank - no sealing - meets IP54 (std'd)

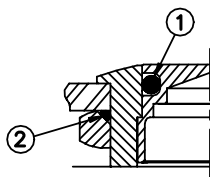

K ① Internal seal & ② front panel seals meet IP65

Sealing

Min. dimensions for matrix mounting: .984" (25mm) x .984" (25mm).

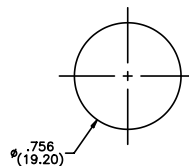

Mounting Hole

Notes to Order Format:

810KM is SPDT

820KM is DPDT

UL option available only with Q option. UL rating: 6 A 125 VAC or 3 A 250 VAC (75% power factor). UL file E66367.

Epoxy terminal seal is standard on all models.

SPECIFICATIONS SUBJECT TO CHANGE WITHOUT NOTICE.

AV SERIES SECURITY PUSHBUTTON SWITCHES

.748" (19mm) bushing diameter

SPECIFICATIONS SUBJECT TO CHANGE WITHOUT NOTICE.

C

SPECIFICATIONS	FEATURES
<p>Contact ratings: Max. resistive loads: Q - 6 A 125 VAC, 3 A 250 VAC or 7 A 30 VDC. B - 0.4 Volt-Amps max at 20 V max.</p> <p>Initial contact resistance: 5 mΩ max. at 3 VDC, 0.1 A</p> <p>Insulation resistance: 200,000 megohms minimum between terminals & case ground.</p> <p>Dielectric strength: 2000 VAC min. between terminals and case ground.</p> <p>Electrical life: 100,000 cycles min.</p> <p>Operating temperature range: -30°C to +85°C</p> <p>For additional specifications: See PB Series switches</p>	<ul style="list-style-type: none"> .755" (19 mm) dia. models. Single pole double throw NO & NC momentary action. Standard - sealing protection per IP54. Optional - sealing protection per IP65. Extremely rugged and durable.
MATERIALS	
<p>Contacts: Q - Coin silver for power & UL models. B - Gold over nickel over brass for dry circuit models.</p> <p>Bushing & Actuator: Nickel plated brass (std'd)</p> <p>Case: Diallyl Phthalate Hex. Mounting Nut: Nickel plated brass</p>	

ORDER FORMAT:	Series Bush./Act. Config. Body Style Term. Type Cont. Matl. Term. Seal Sealing Agency Recognition																
<p>For complete model no., fill in boxes with selected options shown below.</p> <p>Example of complete model no. -</p> <p>AV19PB1-3P2Y1ZQEKUL</p>	<table style="margin: auto;"> <tr> <td style="border: 1px solid black; padding: 5px;">AV</td> <td style="border: 1px solid black; padding: 5px;"> </td> <td style="border: 1px solid black; padding: 5px;">PB13P2Y1</td> <td style="border: 1px solid black; padding: 5px;">Z</td> <td style="border: 1px solid black; padding: 5px;"> </td> <td style="border: 1px solid black; padding: 5px;">E</td> <td style="border: 1px solid black; padding: 5px;">(NONE) K</td> <td style="border: 1px solid black; padding: 5px;">(NONE) UL</td> </tr> <tr> <td></td> <td style="text-align: center;">09 19 29 39 49</td> <td></td> <td></td> <td style="text-align: center;">B Q</td> <td></td> <td></td> <td></td> </tr> </table> <p>For mushroom cap (49) only: Add color code at end of above model number - 0 for natural or 6 for red (consult factory for other colors).</p>	AV		PB13P2Y1	Z		E	(NONE) K	(NONE) UL		09 19 29 39 49			B Q			
AV		PB13P2Y1	Z		E	(NONE) K	(NONE) UL										
	09 19 29 39 49			B Q													

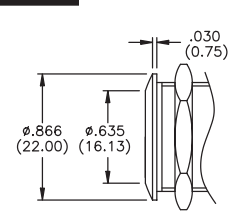
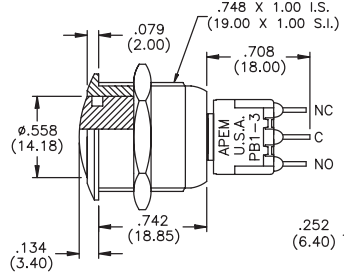
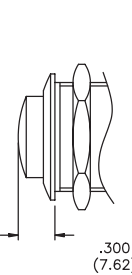
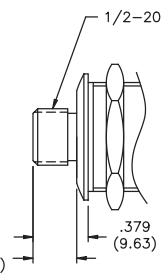
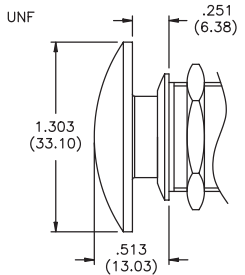
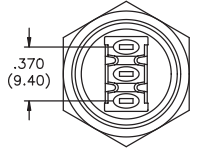
19mm	Bushings/Actuator configuration	Solder lug terminals - (Z)	
 <p>09 flat Act. & curved Bushing</p>	 <p>19 curved Act. & Bushing (standard)</p>	 <p>29 extended Act. & curved bushing</p>	 <p>39 threaded Act. & curved bushing</p>
 <p>49 thd'd Act. with mushroom cap & curved bushing</p>	 <p>Rear view all models</p>		

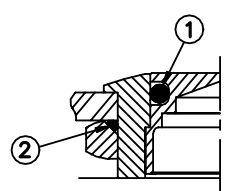
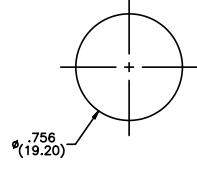
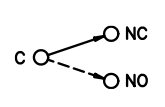
 <p>AV19PB1-3P2Y1ZQE (Model shown)</p>	<p>Blank - no sealing (std'd)</p>  <p>K ① Internal seal & ② front panel seals meet IP65</p>	<p>Min. dimensions for matrix mounting: .984" (25mm) x .984" (25mm).</p>  <p style="text-align: center;">Mounting Hole</p>	<p>Notes to Order Format:</p> <p>UL option available only with Q option. UL rating: 6 A 125 VAC or 3 A 250 VAC (75% power factor). UL file E66367.</p> <p>E option is epoxy terminal seal - standard.</p>
 <p style="text-align: center;">Schematic</p>			

AV SERIES SECURITY PUSHBUTTON SWITCHES

New! Options - Bushing/Actuator materials and marking

After selecting basic model number from previous pages of AV Series Security Pushbutton switches, fill in indicated boxes with desired options below.

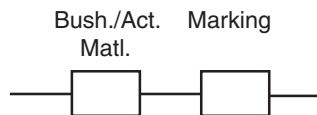

BUSHING/ACTUATOR MATERIAL

Replace **00** with one of the following codes.

models with flat or curved metal actuator

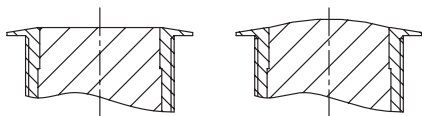

Code	Bushing	Actuator
00 (std'd)	Nickel plated brass	Nickel plated brass
10	Nickel plated brass	Stainless steel
12	Nickel plated brass	Chrome plated brass
20	Chrome plated brass	Chrome plated brass
30	Chrome plated brass	Stainless steel
80	Varnished polished brass	Varnished polished brass

models with flat thermoplastic actuator

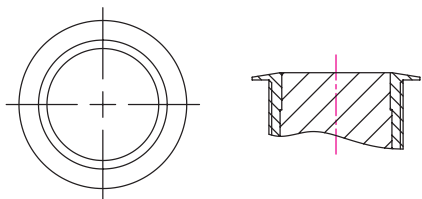

Code	Bushing	Actuator
0X (std'd)	Nickel plated brass	Nickel plated brass
2X	Nickel plated brass	Stainless steel
8X	Nickel plated brass	Chrome plated brass

Replace X above with color: 1 blue, 2 black, 3 green, 4 gray, 5 yellow, 6 red, 7/1 white, 9 orange

MARKING

Select an option from each of the two tables. Consult factory for special symbols.

For models with flat actuator only.
Not available on model AV031202C0.
Marking method: by engraving on metal actuators, (brass only)
by hot stamping on thermoplastic actuators

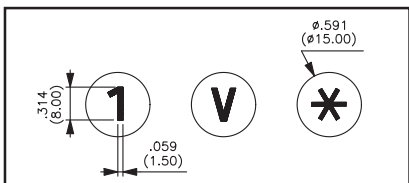

MARKING

Code	Mark
0 to 9	Numbers 0 to 9
X	Symbol *
Y	Symbol #
A to N	Letters A to N
P to W	Letters P to W
0	Letter O
Letter O: same code and design as number 0.	

MARKING COLOR

Code	Color
Brass actuator	
0 (std'd)	Same as finish
2	Black
Note: Code '0' finish cannot be modified to code '2'.	
Thermoplastic actuator	
2	Black
7	White

SPECIFICATIONS SUBJECT TO CHANGE WITHOUT NOTICE.

AV SERIES SNAP-ACTION SECURITY PUSHBUTTON SWITCHES

New! .748" (19mm) bushing diameter - illumination option

SPECIFICATIONS SUBJECT TO CHANGE WITHOUT NOTICE.



SPECIFICATIONS	FEATURES
Contact ratings: 50 mA 24 VDC max. (resistive load) Initial contact resistance: 100 milliohms max. Insulation resistance: 1000 megohms min. at 500 VDC Dielectric strength: 500 V rms min. between terminals 2000 V rms between terminals and bushing Electrical life: 1000,000 cycles at full load Mechanical life: 100,000 cycles at 0.3 A 24V Operating force: 7 N ±2 N Operating temperature range: -30°C to +70°C Panel thickness: .039" (1mm) to .433" (11mm) LED ratings: Two color LED: 2V (3V max.) 20 mA Other colors: 2V (3V max.) 10 mA (Series resistor must be added by user)	<ul style="list-style-type: none"> ● Single pole NO momentary action. ● Standard - panel sealing protection per IP54. ● Optional - panel sealing protection per IP65. ● Extremely rugged and durable.
	MATERIALS
	Contacts: Gold plated dome Terminals: Gold plated brass Bushing & Actuator: Nickel plated brass Case: PBT Hex. Mounting Nut: Nickel plated brass
	LED COLORS
	(NONE) No LED 2 Red/Green 3 Green 5 Yellow 6 Red

ORDER FORMAT: For complete model number, fill in empty boxes with selected options shown below. * - see options on next page

Series	Bush./Act. Config.	Case Style	LED	Function	Contact mat'l.	Terminal type	Bush./Act. mat'l.*	LED color	Marking*	Sealing
AV	<input type="text"/>	C7	<input type="text"/>	<input type="text"/>	D	2	<input type="text"/>	<input type="text"/>	<input type="text"/>	<input type="text"/>
	09 19		L Yes 0 No	3				see above None, 2, 3, 5 or 6		(NONE) K

19mm

Bushing/Actuator configurations

Solder lug terminals (2)

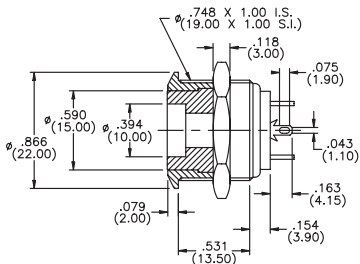

AV09C7L3D200 flat actuator, illuminated

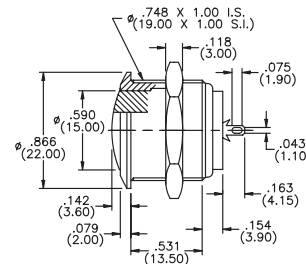
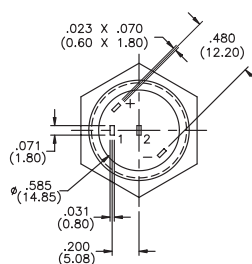

AV19C703D200 curved actuator, non-illuminated



(NONE) - no sealing - meets IP54

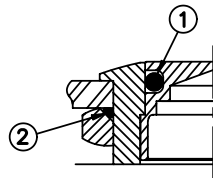

K ① Internal seal & ② front panel seals meet IP65

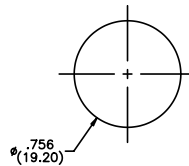

Min. dimensions for matrix mounting: 1.181" (30mm) x 1.181" (30mm).

Complete model no. examples:

Flat actuator, non-illuminated:
AV09C703D200

Curved actuator, non-illuminated:
(not shown)
AV19C703D200

Flat actuator, illuminated:
AV09C7L3D200

STANDARD STOCK MODELS:
AV09C703D200
AV09C703D200K

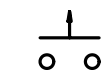

Schematic

Sealing

Mounting Hole

AV SERIES SNAP-ACTION SECURITY PUSHBUTTON SWITCHES

New! Options - Bushing/Actuator materials and marking

After selecting basic model number from previous page of AV Series Snap-action Security Pushbutton switches, fill in indicated boxes with desired options below.

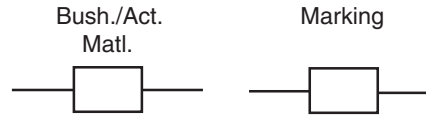

BUSHING/ACTUATOR MATERIAL

Non-illuminated models:

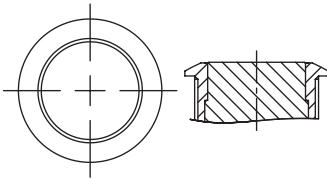

Code	Bushing	Actuator
00 (std'd)	Nickel plated brass	Nickel plated brass
10	Nickel plated brass	Stainless steel
30	Chrome plated brass	Stainless steel
40	Stainless steel	Stainless steel
80	Varnished polished brass	Varnished polished brass

Illuminated models:

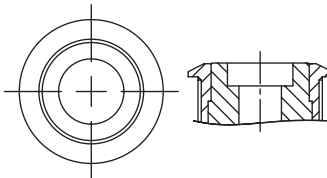

Code	Bushing	Actuator
00 (std'd)	Nickel plated brass	Nickel plated brass
20	Chrome plated brass	Chrome plated brass
40	Stainless steel	Stainless steel
45	Stainless steel	Nickel plated brass
80	Varnished polished brass	Varnished polished brass

MARKING

Select an option from each of the two tables. Consult factory for special symbols.
For models with flat actuator only. Marking method: by engraving on metal actuators, (brass only) by hot stamping on thermoplastic insert (illuminated actuators)

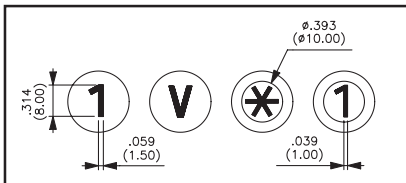

MARKING

Code	Mark
0 to 9	Numbers 0 to 9
X	Symbol *
Y	Symbol #
A to N	Letters A to N
P to W	Letters P to W
0	Letter O
Letter O: same code and design as number 0.	

MARKING COLOR

Code	Color
Non-illuminated actuators	
0 (std'd)	Same as finish
2	Black
Note: Code '0' finish cannot be modified to code '2'.	
Illuminated actuators	
2	Black (on white)

SPECIFICATIONS SUBJECT TO CHANGE WITHOUT NOTICE.

AV SERIES SNAP-ACTION SECURITY PUSHBUTTON SWITCHES

New! WITH REMOVABLE SWITCH BLOCK

SPECIFICATIONS SUBJECT TO CHANGE WITHOUT NOTICE.

C

SPECIFICATIONS

Contact ratings: 6A 250VAC max.- 10mA 5VAC min. (resistive loads)
Initial contact resistance: 10 mΩ max. at 1A 4VDC
Insulation resistance: 50 MΩ min. at 500 VDC
Dielectric strength: 750 V rms min. between terminals
 5 KV rms between terminals and bushing
Electrical life: 50,000 cycles at full load
Mechanical life: 1,000,000 cycles
Contact gap: .047" (1.2mm)
Operating temperature range: -20°C to +55°C
Panel sealing: IP65 per IEC 529
Panel cut-out: .874" (22.2mm) for AV22
 .953" (24.2mm) for AV24

FEATURES

- Single and double poles with alternate action.
- Standard - panel sealing protection per IP65.
- VDE, UL, CSA (CUL) AND BEAB recognized.
- Extremely rugged and durable.
- Switch block easily snaps on or off operator.

MATERIALS

Contacts: Gold plated
Finish: Stainless steel, chrome plated or nickel plated brass or anodized aluminum

OPTIONS Markings and colors

Recessed actuator .787" (20mm) dia. , bushing .866" (22mm) dia.



Stainless steel actuator & bushing
AV22LC40A Single pole
AV22LC40B Double pole

Red anodized actuator, stainless steel bushing
AV22LC46A Single pole
AV22LC46B Double pole

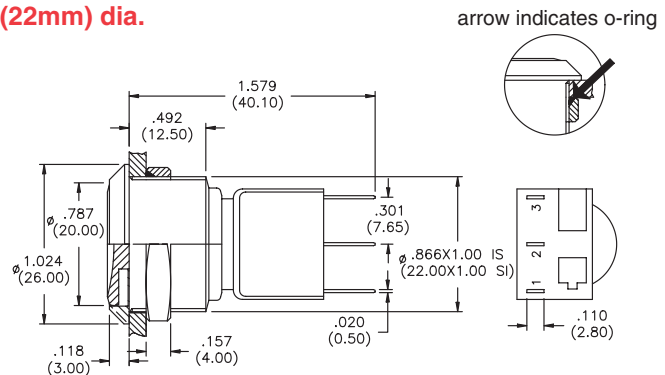

Curved actuator .787" (20mm) dia. , bushing .945" (24mm) dia.



Stainless steel actuator & bushing
AV24LB40A Single pole
AV24LB40B Double pole

Chrome plated actuator & bushing
AV24LB20A Single pole
AV24LB20B Double pole

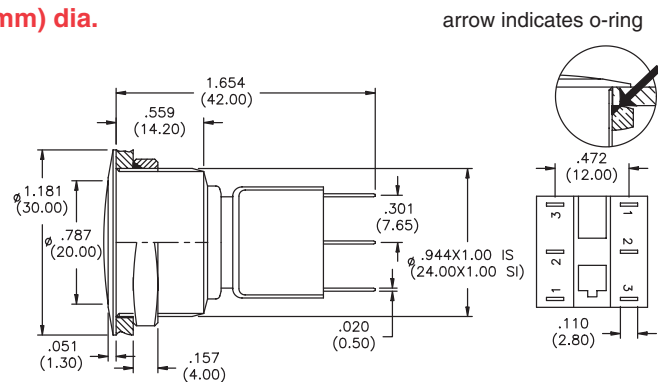

Mushroom head actuator 1.181" (30mm) dia. , bushing .866" (22mm) dia.



Yellow anodized actuator
AV22PNA3A Single pole
AV22PNA3B Double pole

Red anodized actuator
AV22PNA6A Single pole
AV22PNA6B Double pole

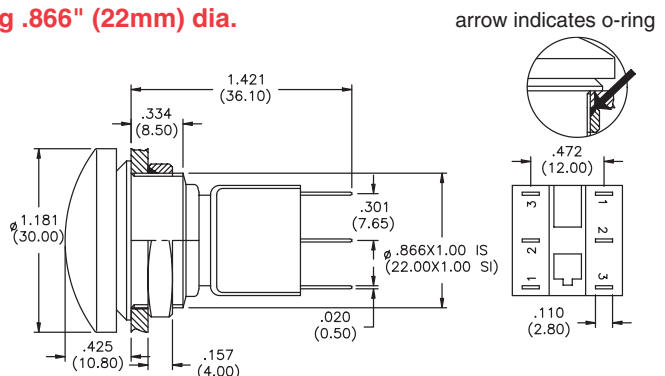

AV SERIES SNAP-ACTION SECURITY PUSHBUTTON SWITCHES

New! WITH REMOVABLE SWITCH BLOCK

C

PRINTED CIRCUIT BOARD SOCKETS

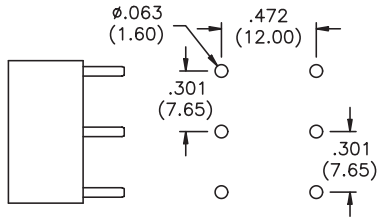

A01PC1 Single pole

A01PC2 Double pole

SWITCH BLOCK

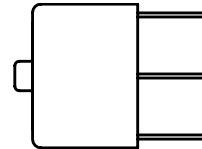

OPERATORS (arrow indicates o-ring)

.787" (20mm) recessed actuator
.866" (22mm) bushing

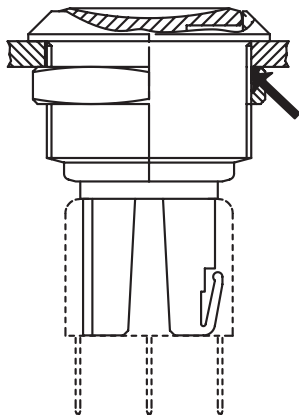

.787" (20mm) curved actuator
.945" (24mm) bushing

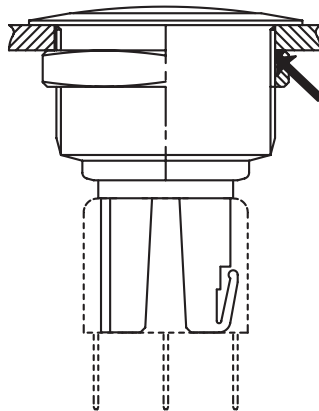

1.181" (30mm) mushroom hd. actuator
.866" (22mm) bushing

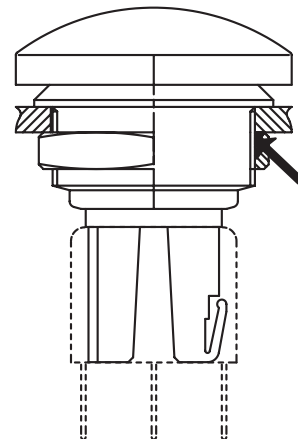

SCHEMATIC

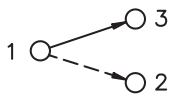

PANEL MOUNTING

Remove switch block from actuator by depressing the latch. Mount operator on pane with hex nut provided. Wire switch block. Slide wired switch block onto operator until latch engages.

SPECIFICATIONS SUBJECT TO CHANGE WITHOUT NOTICE.



Компания «ЭлектроПласт» предлагает заключение долгосрочных отношений при поставках импортных электронных компонентов на взаимовыгодных условиях!

Наши преимущества:

- Оперативные поставки широкого спектра электронных компонентов отечественного и импортного производства напрямую от производителей и с крупнейших мировых складов;
- Поставка более 17-ти миллионов наименований электронных компонентов;
- Поставка сложных, дефицитных, либо снятых с производства позиций;
- Оперативные сроки поставки под заказ (от 5 рабочих дней);
- Экспресс доставка в любую точку России;
- Техническая поддержка проекта, помощь в подборе аналогов, поставка прототипов;
- Система менеджмента качества сертифицирована по Международному стандарту ISO 9001;
- Лицензия ФСБ на осуществление работ с использованием сведений, составляющих государственную тайну;
- Поставка специализированных компонентов (Xilinx, Altera, Analog Devices, Intersil, Interpoint, Microsemi, Aeroflex, Peregrine, Syfer, Eurofarad, Texas Instrument, Miteq, Cobham, E2V, MA-COM, Hittite, Mini-Circuits, General Dynamics и др.);

Помимо этого, одним из направлений компании «ЭлектроПласт» является направление «Источники питания». Мы предлагаем Вам помощь Конструкторского отдела:

- Подбор оптимального решения, техническое обоснование при выборе компонента;
- Подбор аналогов;
- Консультации по применению компонента;
- Поставка образцов и прототипов;
- Техническая поддержка проекта;
- Защита от снятия компонента с производства.



Как с нами связаться

Телефон: 8 (812) 309 58 32 (многоканальный)

Факс: 8 (812) 320-02-42

Электронная почта: org@eplast1.ru

Адрес: 198099, г. Санкт-Петербург, ул. Калинина, дом 2, корпус 4, литера А.