

2.3V to 5.5V Micropower Bi-CMOS Op Amps

Features

- Low Input Offset Voltage: $\pm 150 \mu\text{V}$ (maximum)
- Low Noise: $2.2 \mu\text{V}_{\text{P-P}}$ (typical, 0.1 Hz to 10 Hz)
- Rail-to-Rail Output
- Low Input Offset Current: 0.3 nA (typical)
- Low Quiescent Current: 25 μA (maximum)
- Power Supply Voltage: 2.3V to 5.5V
- Unity Gain Stable
- Chip Select (CS) Capability: MCP618
- Industrial Temperature Range: -40°C to $+85^{\circ}\text{C}$
- No Phase Reversal
- Available in Single, Dual and Quad Packages

Typical Applications

- Battery Power Instruments
- Weight Scales
- Strain Gauges
- Medical Instruments
- Test Equipment

Design Aids

- SPICE Macro Models
- Microchip Advanced Part Selector (MAPS)
- Mindi™ Circuit Designer & Simulator
- Analog Demonstration and Evaluation Boards
- Application Notes

Input Offset Voltage



Description

The MCP616/7/8/9 family of operational amplifiers (op amps) from Microchip Technology Inc. are capable of precision, low-power, single-supply operation. These op amps are unity-gain stable, have low input offset voltage ($\pm 150 \mu\text{V}$, maximum), rail-to-rail output swing and low input offset current (0.3 nA, typical). These features make this family of op amps well suited for battery-powered applications.

The single MCP616, the single MCP618 with Chip Select (CS) and the dual MCP617 are all available in standard 8-lead PDIP, SOIC and MSOP packages. The quad MCP619 is offered in standard 14-lead PDIP, SOIC and TSSOP packages. All devices are fully specified from -40°C to $+85^{\circ}\text{C}$, with power supplies from 2.3V to 5.5V.

Package Types



MCP616/7/8/9

NOTES:

1.0 ELECTRICAL CHARACTERISTICS

Absolute Maximum Ratings †

$V_{DD} - V_{SS}$	7.0V
Current at Analog Input Pins (V_{IN+} and V_{IN-}).....	± 2 mA
Analog Inputs (V_{IN+} and V_{IN-}) †† ..	$V_{SS} - 0.3V$ to $V_{DD} + 0.3V$
All other Inputs and Outputs	$V_{SS} - 0.3V$ to $V_{DD} + 0.3V$
Difference Input Voltage	$ V_{DD} - V_{SS} $
Output Short Circuit Current	Continuous
Current at Output and Supply Pins	± 30 mA
Storage Temperature	$-65^{\circ}C$ to $+150^{\circ}C$
Maximum Junction Temperature (T_J).....	$+150^{\circ}C$
ESD Protection On All Pins (HBM; MM)	≥ 4 kV; 400V

† **Notice:** Stresses above those listed under “Absolute Maximum Ratings” may cause permanent damage to the device. This is a stress rating only and functional operation of the device at those or any other conditions above those indicated in the operational listings of this specification is not implied. Exposure to maximum rating conditions for extended periods may affect device reliability.

†† See Section 4.1.2 “Input Voltage and Current Limits”.

DC ELECTRICAL CHARACTERISTICS

Electrical Specifications: Unless otherwise indicated, $V_{DD} = +2.3V$ to $+5.5V$, $V_{SS} = GND$, $T_A = +25^{\circ}C$, $V_{CM} = V_{DD}/2$, $V_{OUT} \approx V_{DD}/2$ and $R_L = 100$ k Ω to $V_{DD}/2$.

Parameters	Sym	Min	Typ	Max	Units	Conditions
Input Offset						
Input Offset Voltage	V_{OS}	-150	—	+150	μV	
Input Offset Drift with Temperature	$\Delta V_{OS}/\Delta T_A$	—	± 2.5	—	$\mu V/^{\circ}C$	$T_A = -40^{\circ}C$ to $+85^{\circ}C$
Power Supply Rejection	PSRR	86	105	—	dB	
Input Bias Current and Impedance						
Input Bias Current	I_B	-35	-15	-5	nA	
At Temperature	I_B	-70	-21	—	nA	$T_A = -40^{\circ}C$
At Temperature	I_B	—	-12	—	nA	$T_A = +85^{\circ}C$
Input Offset Current	I_{OS}	—	± 0.15	—	nA	
Common Mode Input Impedance	Z_{CM}	—	600 4	—	M Ω pF	
Differential Input Impedance	Z_{DIFF}	—	3 2	—	M Ω pF	
Common Mode						
Common Mode Input Voltage Range	V_{CMR}	V_{SS}		$V_{DD} - 0.9$	V	
Common Mode Rejection Ratio	CMRR	80	100	—	dB	$V_{DD} = 5.0V$, $V_{CM} = 0.0V$ to $4.1V$
Open-Loop Gain						
DC Open-Loop Gain (large signal)	A_{OL}	100	120	—	dB	$R_L = 25$ k Ω to $V_{DD}/2$, $V_{OUT} = 0.05V$ to $V_{DD} - 0.05V$
DC Open-Loop Gain (large signal)	A_{OL}	95	115	—	dB	$R_L = 5$ k Ω to $V_{DD}/2$, $V_{OUT} = 0.1V$ to $V_{DD} - 0.1V$
Output						
Maximum Output Voltage Swing	V_{OL}, V_{OH}	$V_{SS} + 15$	—	$V_{DD} - 20$	mV	$R_L = 25$ k Ω to $V_{DD}/2$, 0.5V input overdrive
	V_{OL}, V_{OH}	$V_{SS} + 45$	—	$V_{DD} - 60$	mV	$R_L = 5$ k Ω to $V_{DD}/2$, 0.5V input overdrive
Linear Output Voltage Range	V_{OUT}	$V_{SS} + 50$	—	$V_{DD} - 50$	mV	$R_L = 25$ k Ω to $V_{DD}/2$, $A_{OL} \geq 100$ dB
	V_{OUT}	$V_{SS} + 100$	—	$V_{DD} - 100$	mV	$R_L = 5$ k Ω to $V_{DD}/2$, $A_{OL} \geq 95$ dB
Output Short Circuit Current	I_{SC}	—	± 7	—	mA	$V_{DD} = 2.3V$
	I_{SC}	—	± 17	—	mA	$V_{DD} = 5.5V$
Power Supply						
Supply Voltage	V_{DD}	2.3	—	5.5	V	
Quiescent Current per Amplifier	I_Q	12	19	25	μA	$I_O = 0$

MCP616/7/8/9

AC ELECTRICAL CHARACTERISTICS

Electrical Specifications: Unless otherwise indicated, $V_{DD} = +2.3V$ to $+5.5V$, $V_{SS} = GND$, $T_A = 25^\circ C$, $V_{CM} = V_{DD}/2$, $V_{OUT} \approx V_{DD}/2$, $R_L = 100\text{ k}\Omega$ to $V_{DD}/2$ and $C_L = 60\text{ pF}$.

Parameters	Sym	Min	Typ	Max	Units	Conditions
AC Response						
Gain Bandwidth Product	GBWP	—	190	—	kHz	
Phase Margin	PM	—	57	—	°	$G = +1V/V$
Slew Rate	SR	—	0.08	—	V/ μs	
Noise						
Input Noise Voltage	E_{ni}	—	2.2	—	μV_{P-P}	$f = 0.1\text{ Hz to }10\text{ Hz}$
Input Noise Voltage Density	e_{ni}	—	32	—	nV/ $\sqrt{\text{Hz}}$	$f = 1\text{ kHz}$
Input Noise Current Density	i_{ni}	—	70	—	fA/ $\sqrt{\text{Hz}}$	$f = 1\text{ kHz}$

MCP618 CHIP SELECT (\overline{CS}) ELECTRICAL CHARACTERISTICS

Electrical Specifications: Unless otherwise indicated, $V_{DD} = +2.3V$ to $+5.5V$, $V_{SS} = GND$, $T_A = 25^\circ C$, $V_{CM} = V_{DD}/2$, $V_{OUT} \approx V_{DD}/2$, $R_L = 100\text{ k}\Omega$ to $V_{DD}/2$ and $C_L = 60\text{ pF}$.

Parameters	Sym	Min	Typ	Max	Units	Conditions
\overline{CS} Low Specifications						
\overline{CS} Logic Threshold, Low	V_{IL}	V_{SS}	—	$0.2 V_{DD}$	V	
\overline{CS} Input Current, Low	I_{CSL}	-1.0	0.01	—	μA	$\overline{CS} = V_{SS}$
\overline{CS} High Specifications						
\overline{CS} Logic Threshold, High	V_{IH}	$0.8 V_{DD}$	—	V_{DD}	V	
\overline{CS} Input Current, High	I_{CSH}	—	0.01	2	μA	$\overline{CS} = V_{DD}$
GND Current	I_{SS}	-2	-0.05	—	μA	$\overline{CS} = V_{DD}$
Amplifier Output Leakage	$I_{O(LEAK)}$	—	10	—	nA	$\overline{CS} = V_{DD}$
\overline{CS} Dynamic Specifications						
\overline{CS} Low to Amplifier Output Turn-on Time	t_{ON}	—	9	100	μs	$\overline{CS} = 0.2V_{DD}$ to $V_{OUT} = 0.9V_{DD}/2$, $G = +1\text{ V/V}$, $R_L = 1\text{ k}\Omega$ to V_{SS}
\overline{CS} High to Amplifier Output High-Z	t_{OFF}	—	0.1	—	μs	$\overline{CS} = 0.8V_{DD}$ to $V_{OUT} = 0.1V_{DD}/2$, $G = +1\text{ V/V}$, $R_L = 1\text{ k}\Omega$ to V_{SS}
\overline{CS} Hysteresis	V_{HYST}	—	0.6	—	V	$V_{DD} = 5.0V$

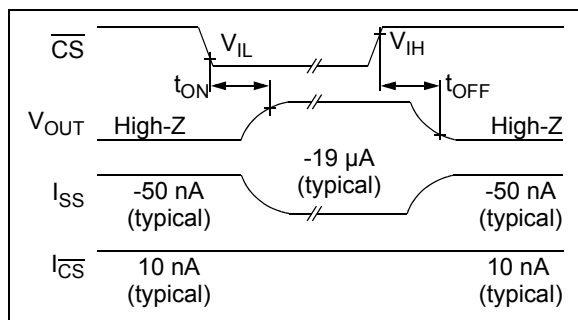

FIGURE 1-1: Timing Diagram for the \overline{CS} Pin on the MCP618.

TEMPERATURE CHARACTERISTICS

Electrical Specifications: Unless otherwise indicated, $V_{DD} = +2.3V$ to $+5.5V$ and $V_{SS} = GND$.						
Parameters	Sym	Min	Typ	Max	Units	Conditions
Temperature Ranges						
Specified Temperature Range	T_A	-40	—	+85	°C	
Operating Temperature Range	T_A	-40	—	+125	°C	Note 1
Storage Temperature Range	T_A	-65	—	+150	°C	
Thermal Package Resistances						
Thermal Resistance, 8L-MSOP	θ_{JA}	—	211	—	°C/W	
Thermal Resistance, 8L-PDIP	θ_{JA}	—	89.3	—	°C/W	
Thermal Resistance, 8L-SOIC	θ_{JA}	—	149.5	—	°C/W	
Thermal Resistance, 14L-PDIP	θ_{JA}	—	70	—	°C/W	
Thermal Resistance, 14L-SOIC	θ_{JA}	—	95.3	—	°C/W	
Thermal Resistance, 14L-TSSOP	θ_{JA}	—	100	—	°C/W	

Note 1: The MCP616/7/8/9 operate over this extended temperature range, but with reduced performance. In any case, the Junction Temperature (T_J) must not exceed the Absolute Maximum specification of $+150^\circ\text{C}$.

1.1 Test Circuits

The test circuits used for the DC and AC tests are shown in [Figure 1-2](#) and [Figure 1-3](#). The bypass capacitors are laid out according to the rules discussed in [Section 4.6 “Supply Bypass”](#).



FIGURE 1-2: AC and DC Test Circuit for Most Non-Inverting Gain Conditions.



FIGURE 1-3: AC and DC Test Circuit for Most Inverting Gain Conditions.

MCP616/7/8/9

NOTES:

2.0 TYPICAL PERFORMANCE CURVES

Note: The graphs and tables provided following this note are a statistical summary based on a limited number of samples and are provided for informational purposes only. The performance characteristics listed herein are not tested or guaranteed. In some graphs or tables, the data presented may be outside the specified operating range (e.g., outside specified power supply range) and therefore outside the warranted range.

Note: Unless otherwise indicated, $V_{DD} = +2.3V$ to $+5.5V$, $V_{SS} = GND$, $T_A = +25^\circ C$, $V_{CM} = V_{DD}/2$, $V_{OUT} \approx V_{DD}/2$, $R_L = 100\text{ k}\Omega$ to $V_{DD}/2$ and $C_L = 60\text{ pF}$.

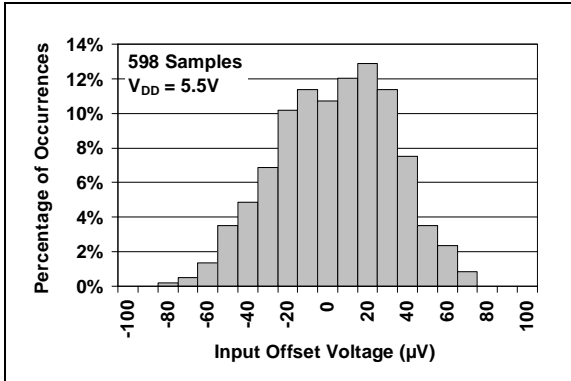

FIGURE 2-1: Input Offset Voltage at $V_{DD} = 5.5V$.

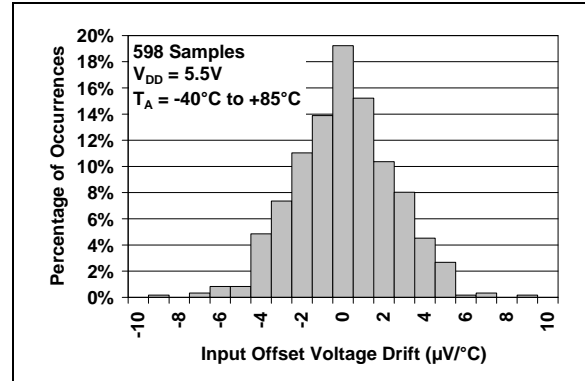

FIGURE 2-4: Input Offset Voltage Drift at $V_{DD} = 5.5V$.

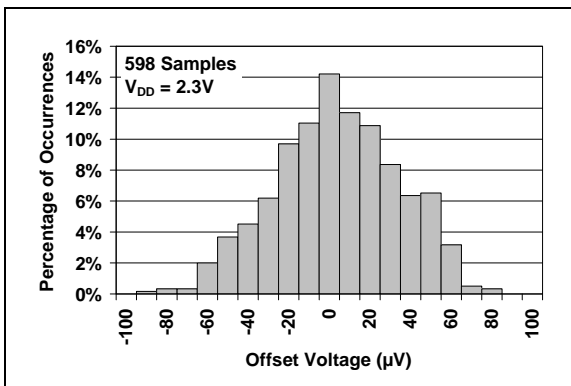

FIGURE 2-2: Input Offset Voltage at $V_{DD} = 2.3V$.

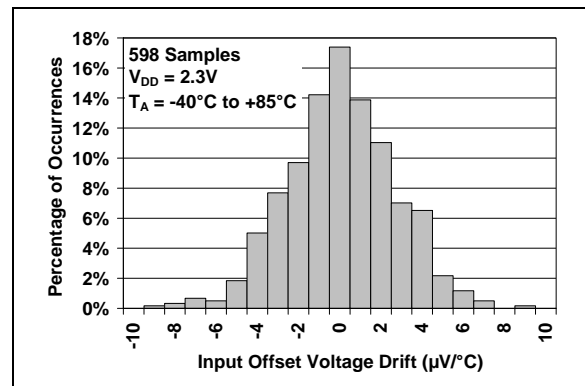

FIGURE 2-5: Input Offset Voltage Drift at $V_{DD} = 2.3V$.

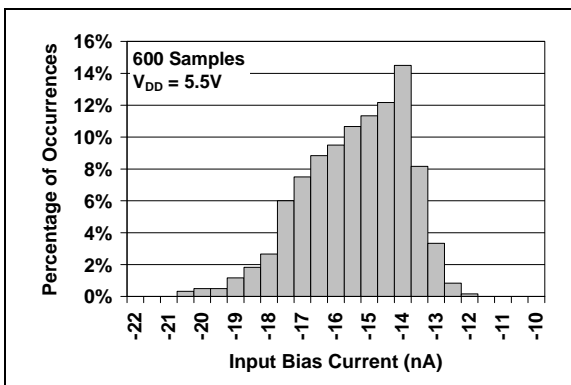

FIGURE 2-3: Input Bias Current at $V_{DD} = 5.5V$.

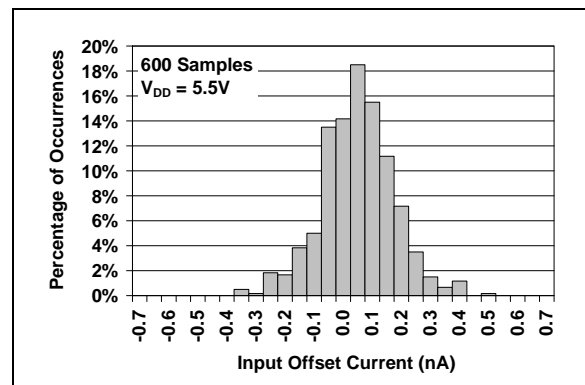

FIGURE 2-6: Input Offset Current at $V_{DD} = 5.5V$.

MCP616/7/8/9

Note: Unless otherwise indicated, $V_{DD} = +2.3V$ to $+5.5V$, $V_{SS} = GND$, $T_A = 25^\circ C$, $V_{CM} = V_{DD}/2$, $V_{OUT} \approx V_{DD}/2$, $R_L = 100\text{ k}\Omega$ to $V_{DD}/2$ and $C_L = 60\text{ pF}$.



FIGURE 2-7: Input Offset Voltage vs. Ambient Temperature.



FIGURE 2-10: Input Bias, Offset Currents vs. Ambient Temperature.



FIGURE 2-8: Quiescent Current vs. Ambient Temperature.



FIGURE 2-11: CMRR, PSRR vs. Ambient Temperature.



FIGURE 2-9: Maximum Output Voltage Swing vs. Ambient Temperature at $R_L = 5\text{ k}\Omega$.



FIGURE 2-12: Maximum Output Voltage Swing vs. Ambient Temperature at $R_L = 25\text{ k}\Omega$.

Note: Unless otherwise indicated, $V_{DD} = +2.3V$ to $+5.5V$, $V_{SS} = GND$, $T_A = 25^\circ C$, $V_{CM} = V_{DD}/2$, $V_{OUT} \approx V_{DD}/2$, $R_L = 100\text{ k}\Omega$ to $V_{DD}/2$ and $C_L = 60\text{ pF}$.

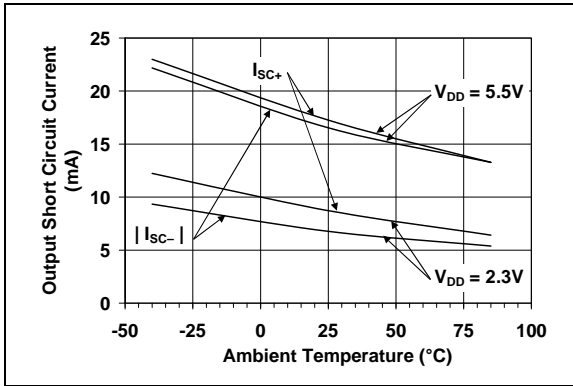

FIGURE 2-13: Output Short Circuit Current vs. Ambient Temperature.

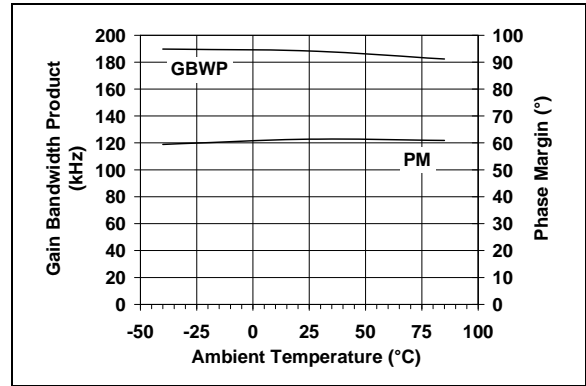

FIGURE 2-16: Gain Bandwidth Product, Phase Margin vs. Ambient Temperature.

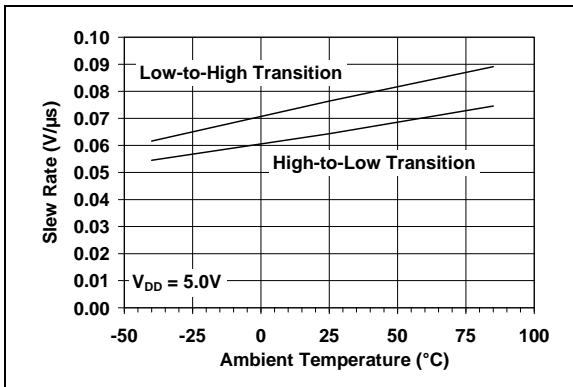

FIGURE 2-14: Slew Rate vs. Ambient Temperature.

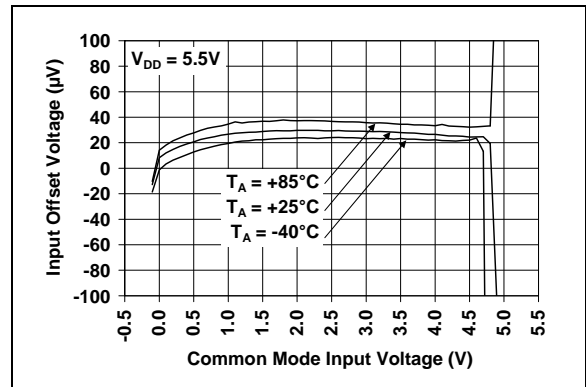

FIGURE 2-17: Input Offset Voltage vs. Common Mode Input Voltage.

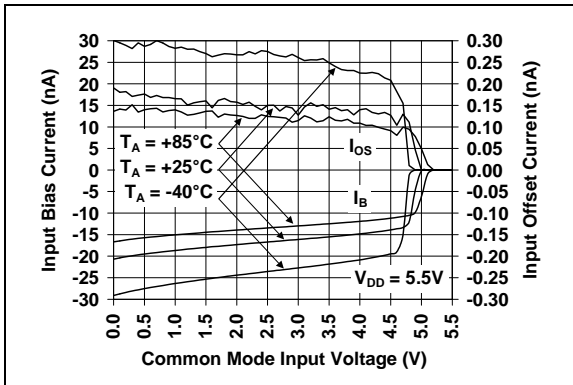

FIGURE 2-15: Input Bias, Offset Currents vs. Common Mode Input Voltage.

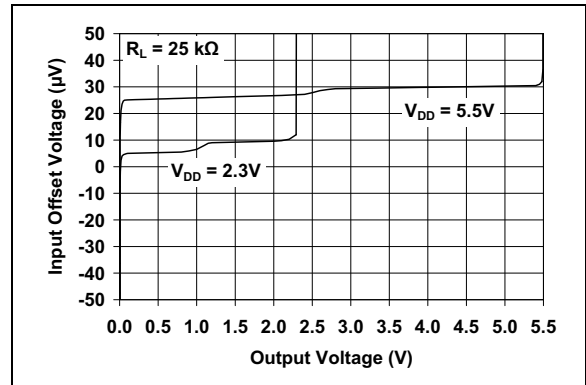

FIGURE 2-18: Input Offset Voltage vs. Output Voltage.

MCP616/7/8/9

Note: Unless otherwise indicated, $V_{DD} = +2.3V$ to $+5.5V$, $V_{SS} = GND$, $T_A = 25^\circ C$, $V_{CM} = V_{DD}/2$, $V_{OUT} \approx V_{DD}/2$, $R_L = 100\text{ k}\Omega$ to $V_{DD}/2$ and $C_L = 60\text{ pF}$.



FIGURE 2-19: Quiescent Current vs. Power Supply Voltage.



FIGURE 2-22: Output Voltage Headroom vs. Output Current Magnitude.



FIGURE 2-20: DC Open-Loop Gain vs. Load Resistance.



FIGURE 2-23: DC Open-Loop Gain vs. Power Supply Voltage.



FIGURE 2-21: Gain-Bandwidth Product, Phase Margin vs. Load Resistance.



FIGURE 2-24: Channel-to-Channel Separation vs. Frequency (MCP617 and MCP619 only).

Note: Unless otherwise indicated, $V_{DD} = +2.3V$ to $+5.5V$, $V_{SS} = GND$, $T_A = 25^\circ C$, $V_{CM} = V_{DD}/2$, $V_{OUT} \approx V_{DD}/2$, $R_L = 100\text{ k}\Omega$ to $V_{DD}/2$ and $C_L = 60\text{ pF}$.

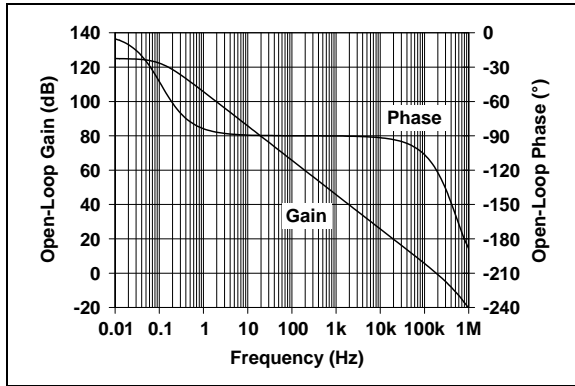

FIGURE 2-25: Open-Loop Gain, Phase vs. Frequency.

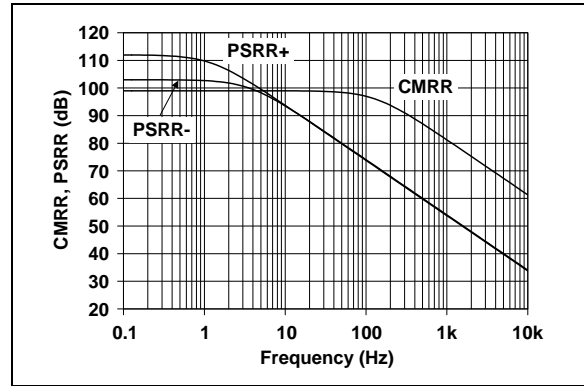

FIGURE 2-28: CMRR, PSRR vs. Frequency.

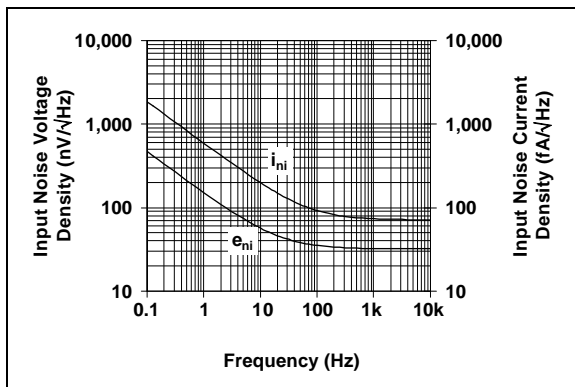

FIGURE 2-26: Input Noise Voltage, Current Densities vs. Frequency.

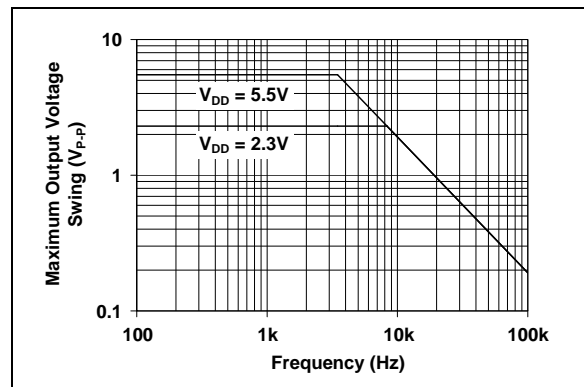

FIGURE 2-29: Maximum Output Voltage Swing vs. Frequency.

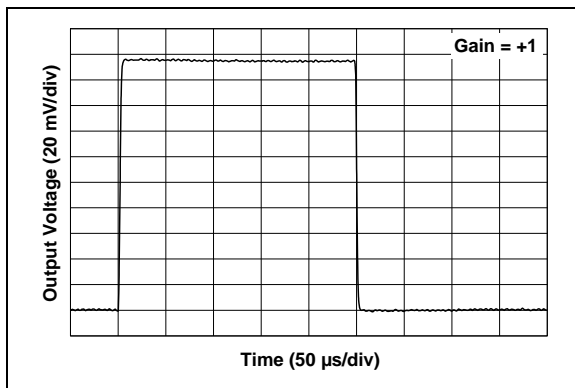

FIGURE 2-27: Small-Signal, Non-Inverting Pulse Response.

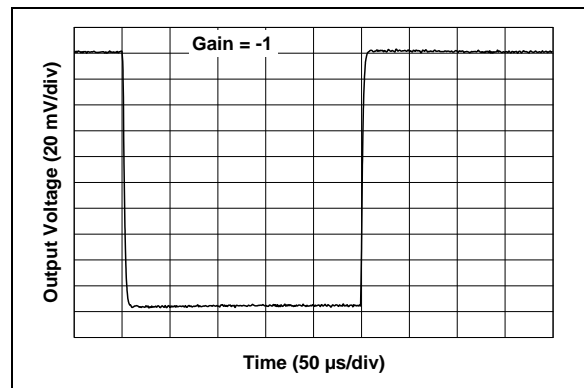

FIGURE 2-30: Small-Signal, Inverting Pulse Response.

MCP616/7/8/9

Note: Unless otherwise indicated, $V_{DD} = +2.3V$ to $+5.5V$, $V_{SS} = GND$, $T_A = 25^\circ C$, $V_{CM} = V_{DD}/2$, $V_{OUT} \approx V_{DD}/2$, $R_L = 100\text{ k}\Omega$ to $V_{DD}/2$ and $C_L = 60\text{ pF}$.



FIGURE 2-31: Large-Signal, Non-Inverting Pulse Response.



FIGURE 2-34: Large-Signal, Inverting Pulse Response.



FIGURE 2-32: Chip Select (\overline{CS}) to Amplifier Output Response Time (MCP618 only).



FIGURE 2-35: Chip Select (\overline{CS}) Internal Hysteresis (MCP618 only).

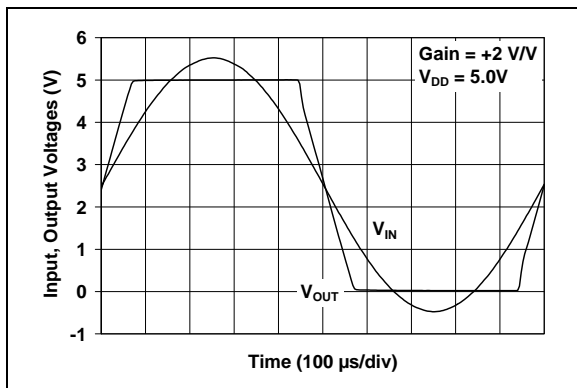

FIGURE 2-33: The MCP616/7/8/9 Show No Phase Reversal.

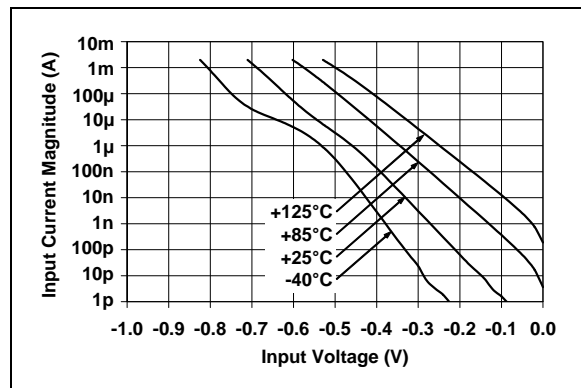

FIGURE 2-36: Measured Input Current vs. Input Voltage (below V_{SS}).

3.0 PIN DESCRIPTIONS

Descriptions of the pins are listed in [Table 3-1](#).

TABLE 3-1: PIN FUNCTION TABLE

MCP616	MCP617	MCP618	MCP619	Symbol	Description
MSOP, PDIP, SOIC	MSOP, PDIP, SOIC	MSOP, PDIP, SOIC	PDIP, SOIC, TSSOP		
6	1	6	1	V_{OUT}, V_{OUTA}	Output (op amp A)
2	2	2	2	V_{IN}^-, V_{INA}^-	Inverting Input (op amp A)
3	3	3	3	V_{IN}^+, V_{INA}^+	Non-inverting Input (op amp A)
7	8	7	4	V_{DD}	Positive Power Supply
—	5	—	5	V_{INB}^+	Non-inverting Input (op amp B)
—	6	—	6	V_{INB}^-	Inverting Input (op amp B)
—	7	—	7	V_{OUTB}	Output (op amp B)
—	—	—	8	V_{OUTC}	Output (op amp B)
—	—	—	9	V_{INC}^-	Inverting Input (op amp C)
—	—	—	10	V_{INC}^+	Non-inverting Input (op amp C)
4	4	4	11	V_{SS}	Negative Power Supply
—	—	—	12	V_{IND}^+	Non-inverting Input (op amp D)
—	—	—	13	V_{IND}^-	Inverting Input (op amp D)
—	—	—	14	V_{OUTD}	Output (op amp D)
—	—	8	—	\overline{CS}	Chip Select
1, 5, 8	—	1, 5	—	NC	No Internal Connection

3.1 Analog Outputs

The output pins are low-impedance voltage sources.

3.2 Analog Inputs

The non-inverting and inverting inputs are high-impedance PNP inputs with low bias currents.

3.3 Chip Select Digital Input (\overline{CS})

This is a CMOS, Schmitt-triggered input that places the MCP618 op amp into a low-power mode of operation.

3.4 Power Supply Pins (V_{DD} , V_{SS})

The positive power supply (V_{DD}) is 2.3V to 5.5V higher than the negative power supply (V_{SS}). For normal operation, the other pins are at voltages between V_{SS} and V_{DD} .

Typically, these parts are used in a single-supply (positive) supply configuration. In this case, V_{SS} is connected to ground and V_{DD} is connected to the supply. V_{DD} will need bypass capacitors.

MCP616/7/8/9

NOTES:

4.0 APPLICATIONS INFORMATION

The MCP616/7/8/9 family of op amps is manufactured using Microchip's state-of-the-art CMOS process, which includes PNP transistors. These op amps are unity-gain stable and suitable for a wide range of general purpose applications.

4.1 Rail-to-Rail Inputs

4.1.1 PHASE REVERSAL

The MCP616/7/8/9 op amp is designed to prevent phase reversal when the input pins exceed the supply voltages. Figure 2-36 shows the input voltage exceeding the supply voltage without any phase reversal.

4.1.2 INPUT VOLTAGE AND CURRENT LIMITS

The ESD protection on the inputs can be depicted as shown in Figure 4-1. This structure was chosen to protect the input transistors, and to minimize input bias current (I_B). The input ESD diodes clamp the inputs when they try to go more than one diode drop below V_{SS} . They also clamp any voltages that go too far above V_{DD} ; their breakdown voltage is high enough to allow normal operation, and low enough to bypass quick ESD events within the specified limits.



FIGURE 4-1: Simplified Analog Input ESD Structures.

In order to prevent damage and/or improper operation of these op amps, the circuit they are in must limit the currents and voltages at the V_{IN+} and V_{IN-} pins (see “**Absolute Maximum Ratings †**” at the beginning of **Section 1.0 “Electrical Characteristics”**). Figure 4-2 shows the recommended approach to protecting these inputs. The internal ESD diodes prevent the input pins (V_{IN+} and V_{IN-}) from going too far below ground, and the resistors R_1 and R_2 limit the possible current drawn out of the input pins. Diodes D_1 and D_2 prevent the input pins (V_{IN+} and V_{IN-}) from going too far above V_{DD} , and dump any currents onto V_{DD} . When implemented as shown, resistors R_1 and R_2 also limit the current through D_1 and D_2 .



FIGURE 4-2: Protecting the Analog Inputs.

It is also possible to connect the diodes to the left of resistors R_1 and R_2 . In this case, current through the diodes D_1 and D_2 needs to be limited by some other mechanism. The resistors then serve as in-rush current limiters; the DC current into the input pins (V_{IN+} and V_{IN-}) should be very small.

A significant amount of current can flow out of the inputs when the common mode voltage (V_{CM}) is below ground (V_{SS}). (See Figure 2-36.) Applications that are high impedance may need to limit the usable voltage range.

4.1.3 NORMAL OPERATION

The inputs of the MCP616/7/8/9 op amps connect to a differential PNP input stage. The common mode input voltage range (V_{CMR}) includes ground in single-supply systems (V_{SS}), but does not include V_{DD} . This means that the amplifier input behaves linearly as long as the common mode input voltage (V_{CM}) is kept within the specified V_{CMR} limits (V_{SS} to $V_{DD}-0.9V$ at $+25^\circ C$).

4.2 DC Offsets

The MCP616/7/8/9 family of op amps have a PNP input differential pair that gives good DC performance. They have very low input offset voltage ($\pm 150 \mu V$, maximum) at $T_A = +25^\circ C$, with a typical bias current of -15 nA (sourced out of the inputs).

There must be a DC path to ground (or power supply) from both inputs, or the op amp will not bias properly. The DC resistances seen by the op amp inputs ($R_1 || R_2$ and $R_4 || R_5$ in Figure 4-3) need to be equal and less than $100 \text{ k}\Omega$, to minimize the total DC offset.

MCP616/7/8/9



FIGURE 4-3: Example Circuit for Calculating DC Offset.

To calculate the DC bias point and DC offset, convert the circuit to its DC equivalent:

- Replace capacitors with open circuits
- Replace inductors with short circuits
- Replace AC voltage sources with short circuits
- Replace AC current sources with open circuits
- Convert DC sources and resistances into their Thevenin equivalent form

The DC equivalent circuit for [Figure 4-3](#) is shown in [Figure 4-4](#).



FIGURE 4-4: Equivalent DC Circuit.

Now calculate the nominal DC bias point with offset:

EQUATION 4-1:

$$G_N = 1 + R_2/R_1$$

$$V_{OOS} = G_N [V_{OS} + I_B ((R_1 \parallel R_2) - R_{EQ}) - I_{OS} ((R_1 \parallel R_2) + R_{EQ}) / 2]$$

$$V_{CM} = V_{EQ} - (I_B + I_{OS}/2) R_{EQ}$$

$$V_{OUT} = V_{EQ} (G_N) - V_I (G_N - 1) + V_{OOS}$$

Where:

G_N	=	op amp's noise gain (from the non-inverting input to the output)
V_{OOS}	=	circuit's output offset voltage
V_{OS}	=	op amp's input offset voltage
I_B	=	op amp's input bias current
I_{OS}	=	op amp's input offset current
V_{CM}	=	op amp's common mode input voltage

Use the worst-case specs and source values to determine the worst-case output voltage range and offset for your design. Make sure the common mode input voltage range and output voltage range are not exceeded.

4.3 Rail-to-Rail Output

There are two specifications that describe the output swing capability of the MCP616/7/8/9 family of op amps. The first specification (Maximum Output Voltage Swing) defines the absolute maximum swing that can be achieved under the specified load conditions. For instance, the output voltage swings to within 15 mV of the negative rail with a 25 kΩ load tied to $V_{DD}/2$. [Figure 2-33](#) shows how the output voltage is limited when the input goes beyond the linear region of operation.

The second specification that describes the output swing capability of these amplifiers is the Linear Output Voltage Range. This specification defines the maximum output swing that can be achieved while the amplifier still operates in its linear region. To verify linear operation in this range, the large-signal DC Open-Loop Gain (A_{OL}) is measured at points inside the supply rails. The measurement must meet the specified A_{OL} conditions in the specification table.

4.4 Capacitive Loads

Driving large capacitive loads can cause stability problems for voltage feedback op amps. As the load capacitance increases, the feedback loop's phase margin decreases and the closed-loop bandwidth is reduced. This produces gain peaking in the frequency response, with overshoot and ringing in the step response. A unity-gain buffer ($G = +1$) is the most sensitive to capacitive loads, though all gains show the same general behavior.

When driving large capacitive loads with these op amps (e.g., $> 60 \text{ pF}$ when $G = +1$), a small series resistor at the output (R_{ISO} in Figure 4-5) improves the feedback loop's phase margin (stability) by making the output load resistive at higher frequencies. The bandwidth will be generally lower than the bandwidth with no capacitive load.

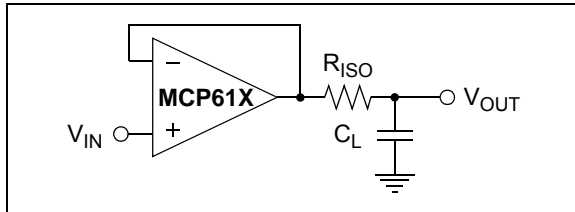

FIGURE 4-5: Output Resistor, R_{ISO} stabilizes large capacitive loads.

Figure 4-6 gives recommended R_{ISO} values for different capacitive loads and gains. The x-axis is the normalized load capacitance (C_L/G_N), where G_N is the circuit's noise gain. For non-inverting gains, G_N and the Signal Gain are equal. For inverting gains, G_N is $1 + |\text{Signal Gain}|$ (e.g., -1 V/V gives $G_N = +2 \text{ V/V}$).

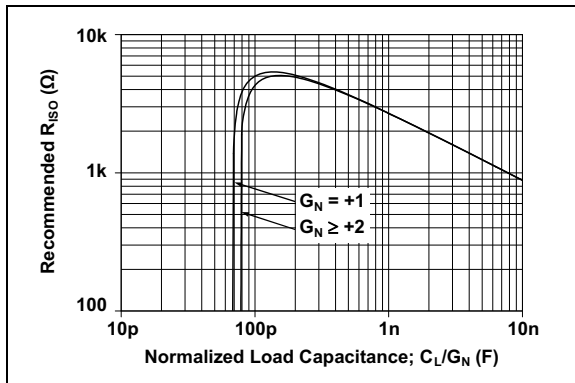

FIGURE 4-6: Recommended R_{ISO} Values for Capacitive Loads.

After selecting R_{ISO} for your circuit, double-check the resulting frequency response peaking and step response overshoot. Modify R_{ISO} 's value until the response is reasonable. Bench evaluation and simulations with the MCP616/7/8/9 SPICE macro model are helpful.

4.5 MCP618 Chip Select (\overline{CS})

The MCP618 is a single op amp with Chip Select (\overline{CS}). When \overline{CS} is pulled high, the supply current drops to 50 nA (typical) and flows through the \overline{CS} pin to V_{SS} . When this happens, the amplifier output is put into a high-impedance state. By pulling \overline{CS} low, the amplifier is enabled. The \overline{CS} pin has an internal $5 \text{ M}\Omega$ (typical) pull-down resistor connected to V_{SS} , so it will go low if the \overline{CS} pins is left floating. Figure 1-1 shows the output voltage and supply current response to a \overline{CS} pulse.

4.6 Supply Bypass

With this family of operational amplifiers, the power supply pin (V_{DD} for single supply) should have a local bypass capacitor (i.e., $0.01 \text{ }\mu\text{F}$ to $0.1 \text{ }\mu\text{F}$) within 2 mm for good high-frequency performance. It may use a bulk capacitor (i.e., $1 \text{ }\mu\text{F}$ or larger) within 100 mm to provide large, slow currents. This bulk capacitor is not required and can be shared with other analog parts.

4.7 Unused Op Amps

An unused op amp in a quad package (MCP619) should be configured as shown in Figure 4-7. These circuits prevent the output from toggling and causing crosstalk. Circuit A sets the op amp at its minimum noise gain. The resistor divider produces any desired reference voltage within the output voltage range of the op amp; the op amp buffers that reference voltage. Circuit B uses the minimum number of components and operates as a comparator, but it may draw more current.



FIGURE 4-7: Unused Op Amps.

MCP616/7/8/9

4.8 PCB Surface Leakage

In applications where low input bias current is critical, Printed Circuit Board (PCB) surface leakage effects need to be considered. Surface leakage is caused by humidity, dust or other contamination on the board. Under low humidity conditions, a typical resistance between nearby traces is $10^{12}\Omega$. A 5V difference would cause 5 pA of current to flow, which is greater than the MCP616/7/8/9 family's bias current at 25°C (1 pA, typical).

The easiest way to reduce surface leakage is to use a guard ring around sensitive pins (or traces). The guard ring is biased at the same voltage as the sensitive pin. An example is shown below in [Figure 4-8](#).

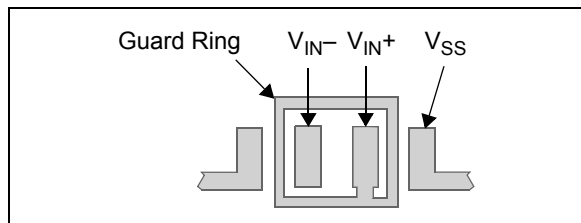

FIGURE 4-8: Example Guard Ring Layout for Inverting Gain.

1. Non-inverting Gain and Unity Gain Buffer:
 - a) Connect the non-inverting pin (V_{IN+}) to the input with a wire that does not touch the PCB surface.
 - b) Connect the guard ring to the inverting input pin (V_{IN-}). This biases the guard ring to the common mode input voltage.
2. Inverting Gain and Transimpedance gain (convert current to voltage, such as photo detectors) amplifiers:
 - a) Connect the guard ring to the non-inverting input pin (V_{IN+}). This biases the guard ring to the same reference voltage as the op amp (e.g., $V_{DD}/2$ or ground).
 - b) Connect the inverting pin (V_{IN-}) to the input with a wire that does not touch the PCB surface.

4.9 Application Circuits

4.9.1 HIGH GAIN PRE-AMPLIFIER

The MCP616/7/8/9 op amps are well suited to amplifying small signals produced by low-impedance sources/sensors. The low offset voltage, low offset current and low noise fit well in this role. [Figure 4-9](#) shows a typical pre-amplifier connected to a low-impedance source (V_S and R_S).

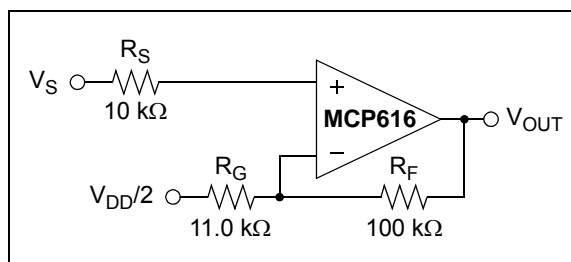

FIGURE 4-9: High Gain Pre-amplifier.

For the best noise and offset performance, the source resistance R_S needs to be less than 15 kΩ. The DC resistances at the inputs are equal to minimize the offset voltage caused by the input bias currents ([Section 4.2 “DC Offsets”](#)). In this circuit, the DC gain is 10 V/V, which will give a typical bandwidth of 19 kHz.

4.9.2 TWO OP AMP INSTRUMENTATION AMPLIFIER

The two-op amp instrumentation amplifier shown in [Figure 4-10](#) serves the function of taking the difference of two input voltages, level-shifting it and gaining it to the output. This configuration is best suited for higher gains (i.e., gain > 3 V/V). The reference voltage (V_{REF}) is typically at mid-supply ($V_{DD}/2$) in a single-supply environment.

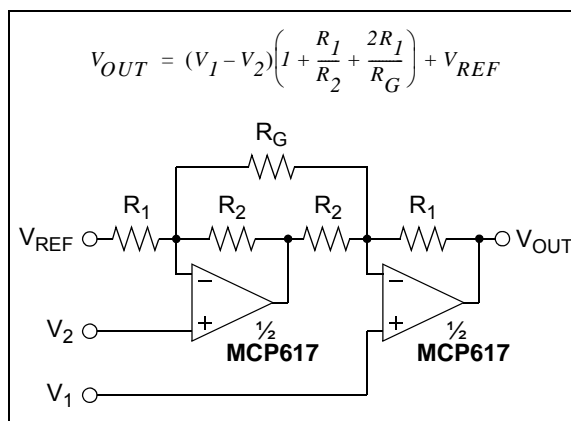

FIGURE 4-10: Two-Op Amp Instrumentation Amplifier.

The key specifications that make the MCP616/7/8/9 family appropriate for this application circuit are low input bias current, low offset voltage and high common-mode rejection.

4.9.3 THREE OP AMP INSTRUMENTATION AMPLIFIER

A classic, three-op amp instrumentation amplifier is illustrated in Figure 4-11. The two-input op amps provide differential signal gain and a common mode gain of +1. The output op amp is a difference amplifier, which converts its input signal from differential to a single-ended output; it rejects common mode signals at its input. The gain of this circuit is simply adjusted with one resistor (R_G). The reference voltage (V_{REF}) is typically referenced to mid-supply ($V_{DD}/2$) in single-supply applications.



FIGURE 4-11: Three-Op Amp Instrumentation Amplifier.

4.9.4 PRECISION GAIN WITH GOOD LOAD ISOLATION

In Figure 4-12, the MCP616 op amp, R_1 and R_2 provide a high gain to the input signal (V_{IN}). The MCP616's low offset voltage makes this an accurate circuit.

The MCP606 is configured as a unity-gain buffer. It isolates the MCP616's output from the load, increasing the high gain stage's precision. Since the MCP606 has a higher output current, and the two amplifiers are housed in separate packages, there is minimal change in the MCP616's offset voltage due to loading effect.

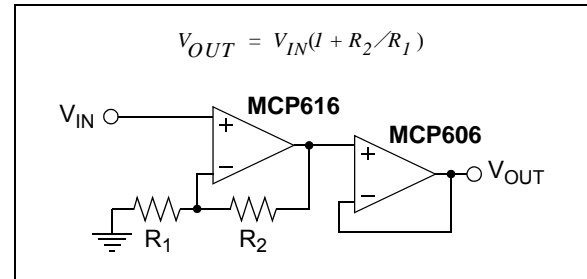

FIGURE 4-12: Precision Gain with Good Load Isolation.

MCP616/7/8/9

NOTES:

5.0 DESIGN AIDS

Microchip provides the basic design tools needed for the MCP616/7/8/9 family of op amps.

5.1 SPICE Macro Model

The latest SPICE macro model for the MCP616/7/8/9 op amps is available on the Microchip web site at www.microchip.com. This model is intended to be an initial design tool that works well in the op amp's linear region of operation over the temperature range. See the model file for information on its capabilities.

Bench testing is a very important part of any design and cannot be replaced with simulations. Also, simulation results using this macro model need to be validated by comparing them to the data sheet specifications and characteristic curves.

5.2 Mindi™ Circuit Designer & Simulator

Microchip's Mindi™ Circuit Designer & Simulator aids in the design of various circuits useful for active filter, amplifier and power-management applications. It is a free online circuit designer & simulator available from the Microchip web site at www.microchip.com/mindi. This interactive circuit designer & simulator enables designers to quickly generate circuit diagrams, simulate circuits. Circuits developed using the Mindi Circuit Designer & Simulator can be downloaded to a personal computer or workstation.

5.3 Microchip Advanced Part Selector (MAPS)

MAPS is a software tool that helps semiconductor professionals efficiently identify Microchip devices that fit a particular design requirement. Available at no cost from the Microchip website at www.microchip.com/maps, the MAPS is an overall selection tool for Microchip's product portfolio that includes Analog, Memory, MCUs and DSCs. Using this tool you can define a filter to sort features for a parametric search of devices and export side-by-side technical comparison reports. Helpful links are also provided for Datasheets, Purchase, and Sampling of Microchip parts.

5.4 Analog Demonstration and Evaluation Boards

Microchip offers a broad spectrum of Analog Demonstration and Evaluation Boards that are designed to help you achieve faster time to market. For a complete listing of these boards and their corresponding user's guides and technical information, visit the Microchip web site at www.microchip.com/analogtools.

Two of our boards that are especially useful are:

- **P/N SOIC8EV:** *8-Pin SOIC/MSOP/TSSOP/DIP Evaluation Board*
- **P/N SOIC14EV:** *14-Pin SOIC/TSSOP/DIP Evaluation Board*

5.5 Application Notes

The following Microchip Application Notes are available on the Microchip web site at www.microchip.com/appnotes and are recommended as supplemental reference resources.

ADN003: *"Select the Right Operational Amplifier for your Filtering Circuits"*, DS21821

AN722: *"Operational Amplifier Topologies and DC Specifications"*, DS00722

AN723: *"Operational Amplifier AC Specifications and Applications"*, DS00723

AN884: *"Driving Capacitive Loads With Op Amps"*, DS00884

AN990: *"Analog Sensor Conditioning Circuits – An Overview"*, DS00990

These application notes and others are listed in the design guide:

"Signal Chain Design Guide", DS21825

MCP616/7/8/9

NOTES:

6.0 PACKAGING INFORMATION

6.1 Package Marking Information

8-Lead MSOP



Example:

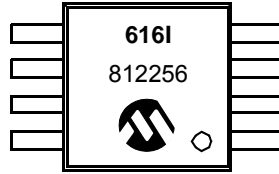

8-Lead PDIP (300 mil)



Examples:



8-Lead SOIC (150 mil)



Examples:



Legend:	XX...X	Customer-specific information
	Y	Year code (last digit of calendar year)
	YY	Year code (last 2 digits of calendar year)
	WW	Week code (week of January 1 is week '01')
	NNN	Alphanumeric traceability code
	(e3)	Pb-free JEDEC designator for Matte Tin (Sn)
	*	This package is Pb-free. The Pb-free JEDEC designator (e3) can be found on the outer packaging for this package.

Note: In the event the full Microchip part number cannot be marked on one line, it will be carried over to the next line, thus limiting the number of available characters for customer-specific information.

MCP616/7/8/9

Package Marking Information (Continued)

14-Lead PDIP (300 mil) (MCP619)

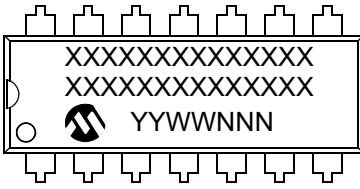

Examples:

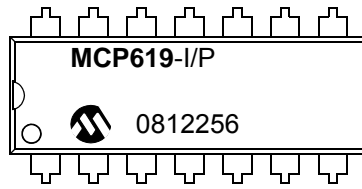

OR

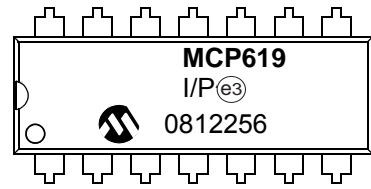

14-Lead SOIC (150 mil) (MCP619)

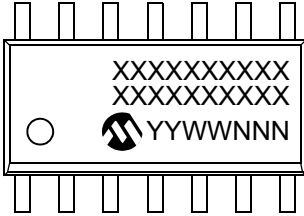

Examples:

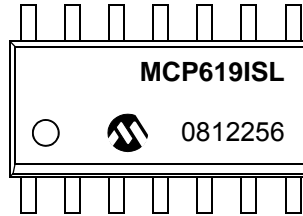

OR

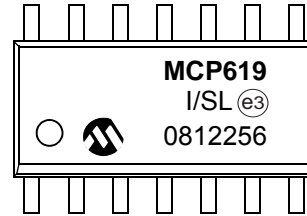

14-Lead TSSOP (MCP619)

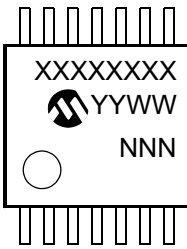

Example:

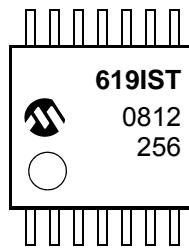

8-Lead Plastic Micro Small Outline Package (MS) [MSOP]

Note: For the most current package drawings, please see the Microchip Packaging Specification located at <http://www.microchip.com/packaging>



Dimension Limits	Units	MILLIMETERS		
		MIN	NOM	MAX
Number of Pins	N	8		
Pitch	e	0.65 BSC		
Overall Height	A	–	–	1.10
Molded Package Thickness	A2	0.75	0.85	0.95
Standoff	A1	0.00	–	0.15
Overall Width	E	4.90 BSC		
Molded Package Width	E1	3.00 BSC		
Overall Length	D	3.00 BSC		
Foot Length	L	0.40	0.60	0.80
Footprint	L1	0.95 REF		
Foot Angle	ϕ	0°	–	8°
Lead Thickness	c	0.08	–	0.23
Lead Width	b	0.22	–	0.40

Notes:

- Pin 1 visual index feature may vary, but must be located within the hatched area.
- Dimensions D and E1 do not include mold flash or protrusions. Mold flash or protrusions shall not exceed 0.15 mm per side.
- Dimensioning and tolerancing per ASME Y14.5M.

BSC: Basic Dimension. Theoretically exact value shown without tolerances.

REF: Reference Dimension, usually without tolerance, for information purposes only.

Microchip Technology Drawing C04-111B

MCP616/7/8/9

8-Lead Plastic Dual In-Line (P) – 300 mil Body [PDIP]

Note: For the most current package drawings, please see the Microchip Packaging Specification located at <http://www.microchip.com/packaging>



Dimension Limits	Units	INCHES		
		MIN	NOM	MAX
Number of Pins	N	8		
Pitch	e	.100 BSC		
Top to Seating Plane	A	–	–	.210
Molded Package Thickness	A2	.115	.130	.195
Base to Seating Plane	A1	.015	–	–
Shoulder to Shoulder Width	E	.290	.310	.325
Molded Package Width	E1	.240	.250	.280
Overall Length	D	.348	.365	.400
Tip to Seating Plane	L	.115	.130	.150
Lead Thickness	c	.008	.010	.015
Upper Lead Width	b1	.040	.060	.070
Lower Lead Width	b	.014	.018	.022
Overall Row Spacing §	eB	–	–	.430

Notes:

- Pin 1 visual index feature may vary, but must be located with the hatched area.
- § Significant Characteristic.
- Dimensions D and E1 do not include mold flash or protrusions. Mold flash or protrusions shall not exceed .010" per side.
- Dimensioning and tolerancing per ASME Y14.5M.

BSC: Basic Dimension. Theoretically exact value shown without tolerances.

Microchip Technology Drawing C04-018B

8-Lead Plastic Small Outline (SN) – Narrow, 3.90 mm Body [SOIC]

Note: For the most current package drawings, please see the Microchip Packaging Specification located at <http://www.microchip.com/packaging>

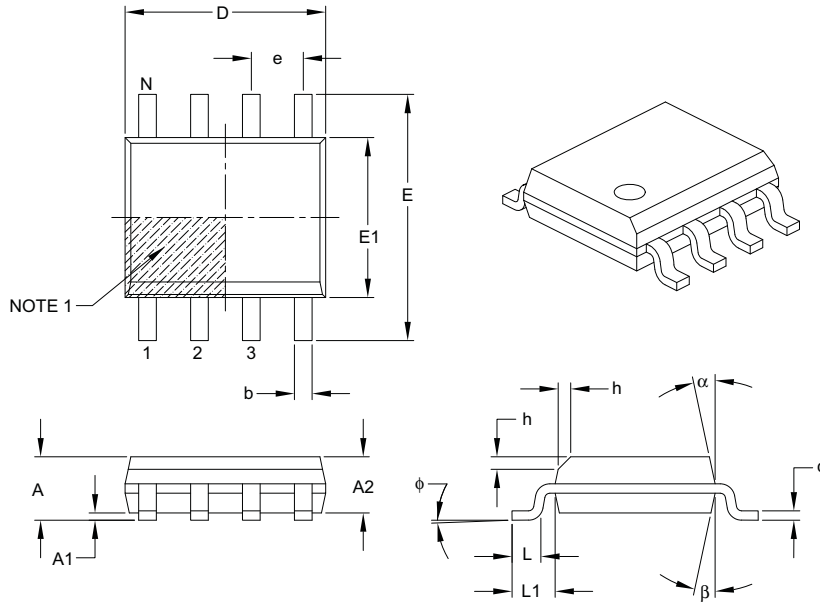

Dimension Limits	Units	MILLIMETERS		
		MIN	NOM	MAX
Number of Pins	N	8		
Pitch	e	1.27 BSC		
Overall Height	A	–	–	1.75
Molded Package Thickness	A2	1.25	–	–
Standoff §	A1	0.10	–	0.25
Overall Width	E	6.00 BSC		
Molded Package Width	E1	3.90 BSC		
Overall Length	D	4.90 BSC		
Chamfer (optional)	h	0.25	–	0.50
Foot Length	L	0.40	–	1.27
Footprint	L1	1.04 REF		
Foot Angle	ϕ	0°	–	8°
Lead Thickness	c	0.17	–	0.25
Lead Width	b	0.31	–	0.51
Mold Draft Angle Top	α	5°	–	15°
Mold Draft Angle Bottom	β	5°	–	15°

Notes:

- Pin 1 visual index feature may vary, but must be located within the hatched area.
- § Significant Characteristic.
- Dimensions D and E1 do not include mold flash or protrusions. Mold flash or protrusions shall not exceed 0.15 mm per side.
- Dimensioning and tolerancing per ASME Y14.5M.

BSC: Basic Dimension. Theoretically exact value shown without tolerances.

REF: Reference Dimension, usually without tolerance, for information purposes only.

Microchip Technology Drawing C04-057B

MCP616/7/8/9

8-Lead Plastic Small Outline (SN) – Narrow, 3.90 mm Body [SOIC]

Note: For the most current package drawings, please see the Microchip Packaging Specification located at <http://www.microchip.com/packaging>



RECOMMENDED LAND PATTERN

Dimension Limits	Units	MILLIMETERS		
		MIN	NOM	MAX
Contact Pitch	E	1.27 BSC		
Contact Pad Spacing	C		5.40	
Contact Pad Width (X8)	X1			0.60
Contact Pad Length (X8)	Y1			1.55

Notes:

1. Dimensioning and tolerancing per ASME Y14.5M

BSC: Basic Dimension. Theoretically exact value shown without tolerances.

Microchip Technology Drawing No. C04-2057A

14-Lead Plastic Dual In-Line (P) – 300 mil Body [PDIP]

Note: For the most current package drawings, please see the Microchip Packaging Specification located at <http://www.microchip.com/packaging>

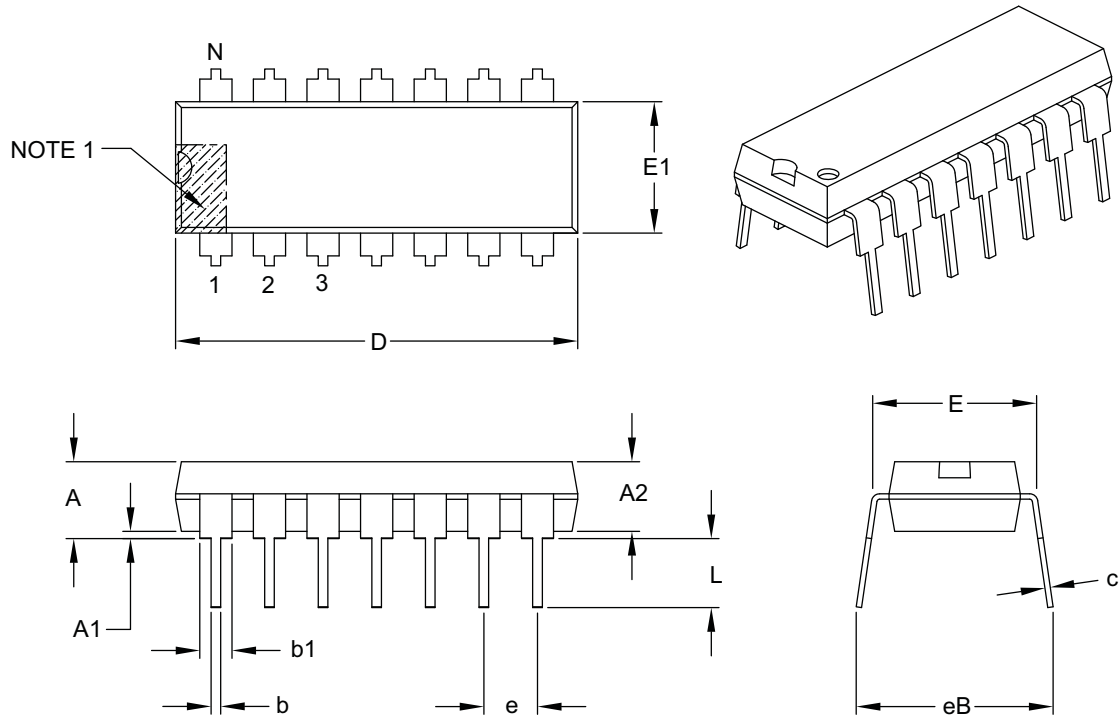

Dimension Limits	Units	INCHES		
		MIN	NOM	MAX
Number of Pins	N	14		
Pitch	e	.100 BSC		
Top to Seating Plane	A	–	–	.210
Molded Package Thickness	A2	.115	.130	.195
Base to Seating Plane	A1	.015	–	–
Shoulder to Shoulder Width	E	.290	.310	.325
Molded Package Width	E1	.240	.250	.280
Overall Length	D	.735	.750	.775
Tip to Seating Plane	L	.115	.130	.150
Lead Thickness	c	.008	.010	.015
Upper Lead Width	b1	.045	.060	.070
Lower Lead Width	b	.014	.018	.022
Overall Row Spacing §	eB	–	–	.430

Notes:

- Pin 1 visual index feature may vary, but must be located with the hatched area.
- § Significant Characteristic.
- Dimensions D and E1 do not include mold flash or protrusions. Mold flash or protrusions shall not exceed .010" per side.
- Dimensioning and tolerancing per ASME Y14.5M.

BSC: Basic Dimension. Theoretically exact value shown without tolerances.

Microchip Technology Drawing C04-005B

MCP616/7/8/9

14-Lead Plastic Small Outline (SL) – Narrow, 3.90 mm Body [SOIC]

Note: For the most current package drawings, please see the Microchip Packaging Specification located at <http://www.microchip.com/packaging>



Dimension Limits	Units	MILLIMETERS		
		MIN	NOM	MAX
Number of Pins	N	14		
Pitch	e	1.27 BSC		
Overall Height	A	–	–	1.75
Molded Package Thickness	A2	1.25	–	–
Standoff §	A1	0.10	–	0.25
Overall Width	E	6.00 BSC		
Molded Package Width	E1	3.90 BSC		
Overall Length	D	8.65 BSC		
Chamfer (optional)	h	0.25	–	0.50
Foot Length	L	0.40	–	1.27
Footprint	L1	1.04 REF		
Foot Angle	ϕ	0°	–	8°
Lead Thickness	c	0.17	–	0.25
Lead Width	b	0.31	–	0.51
Mold Draft Angle Top	α	5°	–	15°
Mold Draft Angle Bottom	β	5°	–	15°

Notes:

- Pin 1 visual index feature may vary, but must be located within the hatched area.
- § Significant Characteristic.
- Dimensions D and E1 do not include mold flash or protrusions. Mold flash or protrusions shall not exceed 0.15 mm per side.
- Dimensioning and tolerancing per ASME Y14.5M.

BSC: Basic Dimension. Theoretically exact value shown without tolerances.

REF: Reference Dimension, usually without tolerance, for information purposes only.

Microchip Technology Drawing C04-065B

14-Lead Plastic Small Outline (SL) - Narrow, 3.90 mm Body [SOIC]

Note: For the most current package drawings, please see the Microchip Packaging Specification located at <http://www.microchip.com/packaging>



RECOMMENDED LAND PATTERN

Dimension Limits	Units	MILLIMETERS		
		MIN	NOM	MAX
Contact Pitch	E	1.27 BSC		
Contact Pad Spacing	C		5.40	
Contact Pad Width	X			0.60
Contact Pad Length	Y			1.50
Distance Between Pads	Gx	0.67		
Distance Between Pads	G	3.90		

Notes:

1. Dimensioning and tolerancing per ASME Y14.5M

BSC: Basic Dimension. Theoretically exact value shown without tolerances.

Microchip Technology Drawing No. C04-2065A

MCP616/7/8/9

14-Lead Plastic Thin Shrink Small Outline (ST) – 4.4 mm Body [TSSOP]

Note: For the most current package drawings, please see the Microchip Packaging Specification located at <http://www.microchip.com/packaging>



Dimension Limits	Units	MILLIMETERS		
		MIN	NOM	MAX
Number of Pins	N	14		
Pitch	e	0.65 BSC		
Overall Height	A	–	–	1.20
Molded Package Thickness	A2	0.80	1.00	1.05
Standoff	A1	0.05	–	0.15
Overall Width	E	6.40 BSC		
Molded Package Width	E1	4.30	4.40	4.50
Molded Package Length	D	4.90	5.00	5.10
Foot Length	L	0.45	0.60	0.75
Footprint	L1	1.00 REF		
Foot Angle	ϕ	0°	–	8°
Lead Thickness	c	0.09	–	0.20
Lead Width	b	0.19	–	0.30

Notes:

- Pin 1 visual index feature may vary, but must be located within the hatched area.
- Dimensions D and E1 do not include mold flash or protrusions. Mold flash or protrusions shall not exceed 0.15 mm per side.
- Dimensioning and tolerancing per ASME Y14.5M.

BSC: Basic Dimension. Theoretically exact value shown without tolerances.

REF: Reference Dimension, usually without tolerance, for information purposes only.

Microchip Technology Drawing C04-087B

APPENDIX A: REVISION HISTORY

Revision C (October 2008)

The following is the list of modifications:

1. Added **Section 1.1 “Test Circuits”**.
2. Added [Figure 2-36](#).
3. Added **Section 4.1.1 “Phase Reversal”**, **Section 4.1.2 “Input Voltage and Current Limits”**, and **Section 4.1.3 “Normal Operation”**.
4. Updated [Figure 4-7](#).
5. Updated **Section 5.0 “Design Aids”**.
6. Updated **Section 6.0 “Packaging Information”**

Revision B (April 2005)

The following is the list of modifications:

1. Clarified specifications found in **Section 1.0 “Electrical Characteristics”**.
2. Updated **Section 2.0 “Typical Performance Curves”** and added input noise current density plot.
3. Added **Section 3.0 “Pin Descriptions”**.
4. Updated **Section 4.0 “Applications Information”**.
5. Updated the SPICE macro model and added information on the FilterLab software, in **Section 5.0 “Design Aids”**.
6. Corrected package marking information (**Section 6.0 “Packaging Information”**).
7. Added **Appendix A: “Revision History”**.

Revision A (April 2001)

- Original Release of this Document.

MCP616/7/8/9

NOTES:

PRODUCT IDENTIFICATION SYSTEM

To order or obtain information, e.g., on pricing or delivery, refer to the factory or the listed sales office.

PART NO.	X	/XX	
Device	Temperature Range	Package	
Device:	MCP616:	Single Operational Amplifier	
	MCP616T:	Single Operational Amplifier (Tape and Reel for SOIC, MSOP)	
	MCP617:	Dual Operational Amplifier	
	MCP617T:	Dual Operational Amplifier (Tape and Reel for SOIC and MSOP)	
	MCP618:	Single Operational Amplifier w/Chip Select (\overline{CS})	
	MCP618T:	Single Operational Amplifier w/Chip Select (\overline{CS}) (Tape and Reel for SOIC and MSOP)	
	MCP619:	Quad Operational Amplifier	
	MCP619T:	Quad Operational Amplifier (Tape and Reel for SOIC and TSSOP)	
Temperature Range:	I	= -40°C to +85°C	
Package:	MS	= Plastic MSOP, 8-lead	
	P	= Plastic DIP (300 mil Body), 8-lead, 14-lead	
	SN	= Plastic SOIC (3.90 mm body), 8-lead	
	SL	= Plastic SOIC (3.90 mm Body), 14-lead (MCP619)	
	ST	= Plastic TSSOP (4.4mm Body), 14-lead (MCP619)	
			Examples:
			a) MCP616-I/P: Industrial Temperature, 8 lead PDIP.
			b) MCP616-I/SN: Industrial Temperature, 8 lead SOIC.
			c) MCP616T-I/MS: Tape and Reel, Industrial Temperature, 8 lead MSOP.
			a) MCP617-I/MS: Industrial Temperature, 8 lead MSOP.
			b) MCP617T-I/MS: Tape and Reel, Industrial Temperature, 8 lead MSOP.
			c) MCP617-I/P: Industrial Temperature, 8 lead PDIP.
			a) MCP618-I/SN: Industrial Temperature, 8 lead SOIC.
			b) MCP618T-I/SN: Tape and Reel, Industrial Temperature, 8 lead SOIC.
			c) MCP618-I/P: Industrial Temperature, 8 lead PDIP.
			a) MCP619T-I/SL: Tape and Reel, Industrial Temperature, 14 lead SOIC.
			b) MCP619T-I/ST: Tape and Reel, Industrial Temperature, 14 lead TSSOP.
			c) MCP619-I/P: Industrial Temperature, 14 lead PDIP.

MCP616/7/8/9

NOTES:

Note the following details of the code protection feature on Microchip devices:

- Microchip products meet the specification contained in their particular Microchip Data Sheet.
- Microchip believes that its family of products is one of the most secure families of its kind on the market today, when used in the intended manner and under normal conditions.
- There are dishonest and possibly illegal methods used to breach the code protection feature. All of these methods, to our knowledge, require using the Microchip products in a manner outside the operating specifications contained in Microchip's Data Sheets. Most likely, the person doing so is engaged in theft of intellectual property.
- Microchip is willing to work with the customer who is concerned about the integrity of their code.
- Neither Microchip nor any other semiconductor manufacturer can guarantee the security of their code. Code protection does not mean that we are guaranteeing the product as "unbreakable."

Code protection is constantly evolving. We at Microchip are committed to continuously improving the code protection features of our products. Attempts to break Microchip's code protection feature may be a violation of the Digital Millennium Copyright Act. If such acts allow unauthorized access to your software or other copyrighted work, you may have a right to sue for relief under that Act.

Information contained in this publication regarding device applications and the like is provided only for your convenience and may be superseded by updates. It is your responsibility to ensure that your application meets with your specifications. MICROCHIP MAKES NO REPRESENTATIONS OR WARRANTIES OF ANY KIND WHETHER EXPRESS OR IMPLIED, WRITTEN OR ORAL, STATUTORY OR OTHERWISE, RELATED TO THE INFORMATION, INCLUDING BUT NOT LIMITED TO ITS CONDITION, QUALITY, PERFORMANCE, MERCHANTABILITY OR FITNESS FOR PURPOSE. Microchip disclaims all liability arising from this information and its use. Use of Microchip devices in life support and/or safety applications is entirely at the buyer's risk, and the buyer agrees to defend, indemnify and hold harmless Microchip from any and all damages, claims, suits, or expenses resulting from such use. No licenses are conveyed, implicitly or otherwise, under any Microchip intellectual property rights.

Trademarks

The Microchip name and logo, the Microchip logo, Accuron, dsPIC, KEELOQ, KEELOQ logo, MPLAB, PIC, PICmicro, PICSTART, rfPIC, SmartShunt and UNI/O are registered trademarks of Microchip Technology Incorporated in the U.S.A. and other countries.

FilterLab, Linear Active Thermistor, MXDEV, MXLAB, SEEVAL, SmartSensor and The Embedded Control Solutions Company are registered trademarks of Microchip Technology Incorporated in the U.S.A.

Analog-for-the-Digital Age, Application Maestro, CodeGuard, dsPICDEM, dsPICDEM.net, dsPICworks, dsSPEAK, ECAN, ECONOMONITOR, FanSense, In-Circuit Serial Programming, ICSP, ICEPIC, Mindi, MiWi, MPASM, MPLAB Certified logo, MPLIB, MPLINK, mTouch, PICkit, PICDEM, PICDEM.net, PICtail, PIC³² logo, PowerCal, PowerInfo, PowerMate, PowerTool, REAL ICE, rfLAB, Select Mode, Total Endurance, WiperLock and ZENA are trademarks of Microchip Technology Incorporated in the U.S.A. and other countries.

SQTP is a service mark of Microchip Technology Incorporated in the U.S.A.

All other trademarks mentioned herein are property of their respective companies.

© 2008, Microchip Technology Incorporated, Printed in the U.S.A., All Rights Reserved.

 Printed on recycled paper.

QUALITY MANAGEMENT SYSTEM
CERTIFIED BY DNV
== ISO/TS 16949:2002 ==

Microchip received ISO/TS-16949:2002 certification for its worldwide headquarters, design and wafer fabrication facilities in Chandler and Tempe, Arizona; Gresham, Oregon and design centers in California and India. The Company's quality system processes and procedures are for its PIC® MCUs and dsPIC® DSCs, KEELOQ® code hopping devices, Serial EEPROMs, microperipherals, nonvolatile memory and analog products. In addition, Microchip's quality system for the design and manufacture of development systems is ISO 9001:2000 certified.



WORLDWIDE SALES AND SERVICE

AMERICAS

Corporate Office
2355 West Chandler Blvd.
Chandler, AZ 85224-6199
Tel: 480-792-7200
Fax: 480-792-7277
Technical Support:
<http://support.microchip.com>
Web Address:
www.microchip.com

Atlanta
Duluth, GA
Tel: 678-957-9614
Fax: 678-957-1455

Boston
Westborough, MA
Tel: 774-760-0087
Fax: 774-760-0088

Chicago
Itasca, IL
Tel: 630-285-0071
Fax: 630-285-0075

Dallas
Addison, TX
Tel: 972-818-7423
Fax: 972-818-2924

Detroit
Farmington Hills, MI
Tel: 248-538-2250
Fax: 248-538-2260

Kokomo
Kokomo, IN
Tel: 765-864-8360
Fax: 765-864-8387

Los Angeles
Mission Viejo, CA
Tel: 949-462-9523
Fax: 949-462-9608

Santa Clara
Santa Clara, CA
Tel: 408-961-6444
Fax: 408-961-6445

Toronto
Mississauga, Ontario,
Canada
Tel: 905-673-0699
Fax: 905-673-6509

ASIA/PACIFIC

Asia Pacific Office
Suites 3707-14, 37th Floor
Tower 6, The Gateway
Harbour City, Kowloon
Hong Kong
Tel: 852-2401-1200
Fax: 852-2401-3431

Australia - Sydney
Tel: 61-2-9868-6733
Fax: 61-2-9868-6755

China - Beijing
Tel: 86-10-8528-2100
Fax: 86-10-8528-2104

China - Chengdu
Tel: 86-28-8665-5511
Fax: 86-28-8665-7889

China - Hong Kong SAR
Tel: 852-2401-1200
Fax: 852-2401-3431

China - Nanjing
Tel: 86-25-8473-2460
Fax: 86-25-8473-2470

China - Qingdao
Tel: 86-532-8502-7355
Fax: 86-532-8502-7205

China - Shanghai
Tel: 86-21-5407-5533
Fax: 86-21-5407-5066

China - Shenyang
Tel: 86-24-2334-2829
Fax: 86-24-2334-2393

China - Shenzhen
Tel: 86-755-8203-2660
Fax: 86-755-8203-1760

China - Wuhan
Tel: 86-27-5980-5300
Fax: 86-27-5980-5118

China - Xiamen
Tel: 86-592-2388138
Fax: 86-592-2388130

China - Xian
Tel: 86-29-8833-7252
Fax: 86-29-8833-7256

China - Zhuhai
Tel: 86-756-3210040
Fax: 86-756-3210049

ASIA/PACIFIC

India - Bangalore
Tel: 91-80-4182-8400
Fax: 91-80-4182-8422

India - New Delhi
Tel: 91-11-4160-8631
Fax: 91-11-4160-8632

India - Pune
Tel: 91-20-2566-1512
Fax: 91-20-2566-1513

Japan - Yokohama
Tel: 81-45-471- 6166
Fax: 81-45-471-6122

Korea - Daegu
Tel: 82-53-744-4301
Fax: 82-53-744-4302

Korea - Seoul
Tel: 82-2-554-7200
Fax: 82-2-558-5932 or
82-2-558-5934

Malaysia - Kuala Lumpur
Tel: 60-3-6201-9857
Fax: 60-3-6201-9859

Malaysia - Penang
Tel: 60-4-227-8870
Fax: 60-4-227-4068

Philippines - Manila
Tel: 63-2-634-9065
Fax: 63-2-634-9069

Singapore
Tel: 65-6334-8870
Fax: 65-6334-8850

Taiwan - Hsin Chu
Tel: 886-3-572-9526
Fax: 886-3-572-6459

Taiwan - Kaohsiung
Tel: 886-7-536-4818
Fax: 886-7-536-4803

Taiwan - Taipei
Tel: 886-2-2500-6610
Fax: 886-2-2508-0102

Thailand - Bangkok
Tel: 66-2-694-1351
Fax: 66-2-694-1350

EUROPE

Austria - Wels
Tel: 43-7242-2244-39
Fax: 43-7242-2244-393

Denmark - Copenhagen
Tel: 45-4450-2828
Fax: 45-4485-2829

France - Paris
Tel: 33-1-69-53-63-20
Fax: 33-1-69-30-90-79

Germany - Munich
Tel: 49-89-627-144-0
Fax: 49-89-627-144-44

Italy - Milan
Tel: 39-0331-742611
Fax: 39-0331-466781

Netherlands - Drunen
Tel: 31-416-690399
Fax: 31-416-690340

Spain - Madrid
Tel: 34-91-708-08-90
Fax: 34-91-708-08-91

UK - Wokingham
Tel: 44-118-921-5869
Fax: 44-118-921-5820



Компания «ЭлектроПласт» предлагает заключение долгосрочных отношений при поставках импортных электронных компонентов на взаимовыгодных условиях!

Наши преимущества:

- Оперативные поставки широкого спектра электронных компонентов отечественного и импортного производства напрямую от производителей и с крупнейших мировых складов;
- Поставка более 17-ти миллионов наименований электронных компонентов;
- Поставка сложных, дефицитных, либо снятых с производства позиций;
- Оперативные сроки поставки под заказ (от 5 рабочих дней);
- Экспресс доставка в любую точку России;
- Техническая поддержка проекта, помощь в подборе аналогов, поставка прототипов;
- Система менеджмента качества сертифицирована по Международному стандарту ISO 9001;
- Лицензия ФСБ на осуществление работ с использованием сведений, составляющих государственную тайну;
- Поставка специализированных компонентов (Xilinx, Altera, Analog Devices, Intersil, Interpoint, Microsemi, Aeroflex, Peregrine, Syfer, Eurofarad, Texas Instrument, Miteq, Cobham, E2V, MA-COM, Hittite, Mini-Circuits, General Dynamics и др.);

Помимо этого, одним из направлений компании «ЭлектроПласт» является направление «Источники питания». Мы предлагаем Вам помощь Конструкторского отдела:

- Подбор оптимального решения, техническое обоснование при выборе компонента;
- Подбор аналогов;
- Консультации по применению компонента;
- Поставка образцов и прототипов;
- Техническая поддержка проекта;
- Защита от снятия компонента с производства.



Как с нами связаться

Телефон: 8 (812) 309 58 32 (многоканальный)

Факс: 8 (812) 320-02-42

Электронная почта: org@eplast1.ru

Адрес: 198099, г. Санкт-Петербург, ул. Калинина, дом 2, корпус 4, литера А.