



## Rail-to-Rail Output, High Quality Audio, Dual Operational Amplifier

### ■ GENERAL DESCRIPTION

The MUSES8832 is a Rail-to-Rail output High quality audio operational amplifier, which is optimized for high-end audio and portable audio applications.

The MUSES8832 features 2.1nV/ $\sqrt{\text{Hz}}$  low noise, 10MHz wide gain bandwidth, 0.0009% low distortion, 600 $\Omega$  drive capability, -40°C to +125°C operating temperature range, and various reliabilities and conveniences are improved.

It is the best for audio preamplifiers, active filters, microphone amplifiers, and line amplifiers with excellent sound.

### ■ APPLICATIONS

- Home Audio
- PC Audio
- Portable Audio
- Car Audio

### ■ FEATURES

- Operating Voltage                    +2.7V to +14V  
     $\pm 1.35\text{V}$  to  $\pm 7.0\text{V}$
- Low Noise                                2.1nV/ $\sqrt{\text{Hz}}$  typ. at f=1kHz  
    0.3 $\mu\text{Vrms}$  typ. (20Hz to 20kHz)
- Output Current                         32mA typ. (Capability of driving 600 $\Omega$  loads)
- GBW                                        10MHz typ.
- Low Distortion                         0.0009% typ. at  $V_{\text{+}}=+5\text{V}$ ,  $V_{\text{o}}=1.3\text{Vrms}$
- Slew Rate                                1V/ $\mu\text{s}$  typ.
- Bipolar Technology
- Package Outline                        SOP8 JEDEC 150 mil, SSOP8-A3
- Operating Temperature Range    -40 to +125°C

### ■ PACKAGE OUTLINE



MUSES8832E  
(SOP8 JEDEC 150 mil)



MUSES8832VA3  
(SSOP8-A3)

### ■ PIN CONFIGURATION

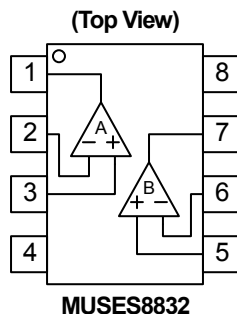

#### PIN FUNCTION

1. A OUTPUT
2. A -INPUT
3. A +INPUT
4. V-
5. B +INPUT
6. B -INPUT
7. B OUTPUT
8. V+



MUSES and this logo are trademarks of New Japan Radio Co., Ltd.

# MUSES8832

## ■ ABSOLUTE MAXIMUM RATINGS (Ta=25°C)

PARAMETER	SYMBOL	RATING	UNIT
Supply Voltage	$V^+$ ( $V^+V$ )	+15 ( $\pm 7.5$ )	V
Input Voltage	$V_{IN}$	+15 (Note1)	V
Differential Input Voltage	$V_{ID}$	$\pm 15$	V
Power Dissipation	$P_D$	SOP8 JEDEC 150 mil: 900 SSOP8-A3: 650(Note2)	mW
Operating Temperature Range	$T_{opr}$	-40 to +125	°C
Storage Temperature Range	$T_{stg}$	-65 to +150	°C

(Note1) For supply Voltages less than +15 V, the maximum input voltage is equal to the Supply Voltage.

(Note2) Mounted on the EIA/JEDEC standard board (114.3×76.2×1.6mm, two layer, FR-4).

## ■ RECOMMENDED OPERATING CONDITION (Ta=25°C)

PARAMETER	SYMBOL	TEST CONDITION	MIN.	TYP.	MAX.	UNIT
Supply Voltage	$V^+$		+2.7	-	+14.0	V
	$V^+V$		$\pm 1.35$	-	$\pm 7.0$	V

## ■ ELECTRIC CHARACTERISTICS

$V^+ = +5V$ ,  $V = 0V$ ,  $T_a = 25^\circ C$ ,  $R_L$  to  $V^+/2$ , unless otherwise specified

PARAMETER	SYMBOL	TEST CONDITION	MIN.	TYP.	MAX.	UNIT
Supply Current	$I_{CC}$	No Signal, $R_L = \infty$	-	7.5	10	mA
Power Dissipation	$P_D$	No Signal	-	42.5	60	mW
Input Offset Voltage	$V_{IO}$	$R_S = 50\Omega$	-	0.1	0.5	mV
Input Bias Current	$I_B$		-	4	6.5	$\mu A$
Input Offset Current	$I_{IO}$		-	100	500	nA
Open-Loop Voltage Gain	$A_V$	$R_L = 10k\Omega$ to $V^+/2$ , $V_O = 0.5$ to $4.5V$	90	115	-	dB
Common Mode Input Voltage Range	$V_{ICM}$	CMR $\geq 90$ dB	0.5	-	3.7	V
Common Mode Rejection Ratio	CMR	$R_S = 50\Omega$	90	110	-	dB
Supply Voltage Rejection Ratio	SVR	$R_S = 50\Omega$	90	105	-	dB
Maximum Output Voltage 1	$V_{OH1}$	$R_L = 10k\Omega$ to $0V$	4.9	4.95	-	V
	$V_{OL1}$	$R_L = 10k\Omega$ to $0V$	-	0.05	0.1	V
Maximum Output Voltage 2	$V_{OH2}$	$R_L = 600\Omega$ to $V^+/2$	4.8	4.9	-	V
	$V_{OL2}$	$R_L = 600\Omega$ to $V^+/2$	-	0.1	0.2	V
Output Source Current	$I_{SOURCE}$	$V_O = V^+ - 0.5V$	10	32	-	mA
Output Sink Current	$I_{SINK}$	$V_O = 0.5V$	10	20	-	mA
Gain Bandwidth Product	GBW	$f = 10kHz$	-	10	-	MHz
Slew Rate	SR	$R_L = 2k\Omega$	-	1	-	V/ $\mu s$
Total Harmonic Distortion + Noise	THD+N	Gain=10, $V_O = 1.3V_{rms}$ , $R_L = 2k\Omega$ , $f = 1kHz$	-	0.0009	-	%
Channel Separation	CS	Gain=100, $R_S = 1k\Omega$ , $R_L = 10k\Omega$ , $f = 1kHz$	-	140	-	dB
Input Noise Voltage1	$e_n$	$f = 1kHz$	-	2.1	-	nV/ $\sqrt{Hz}$
Input Noise Voltage2	$V_n$	$f = 20Hz$ to $20kHz$	-	0.30	-	$\mu V_{rms}$

■ **NOTE**

1. The closed gain should be 6dB or higher to prevent the oscillation. Unity gain follower application may cause the oscillation.
2. Minimize the load capacitor for the better performance. A large load capacitor CL reduces the frequency response and causes oscillation or ringing.
3. Be careful to the circuit of high impedance. Input bias current influences an input noise and output offset voltage.

■ **APPLICATION CIRCUIT**

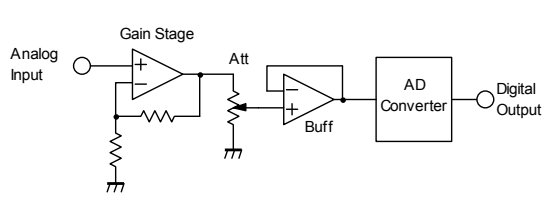

(Fig.1:ADC Input)

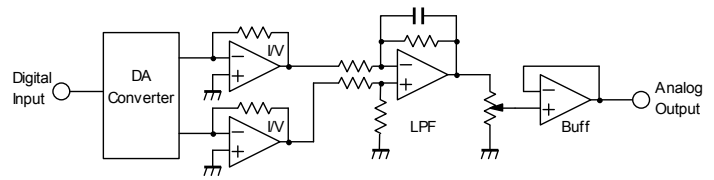

(Fig.2:DAC Output)

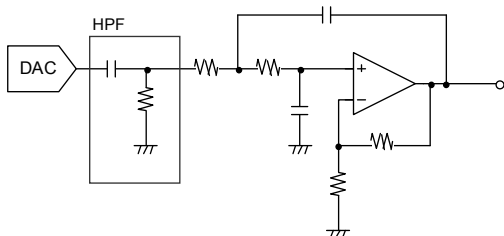

(Fig.3:DAC LPF Circuit )

# MUSES8832

## ■ TYPICAL CHARACTERISTICS ( $V^- = 0V$ , $V_{CM} = V^+ / 2$ , unless otherwise specified)

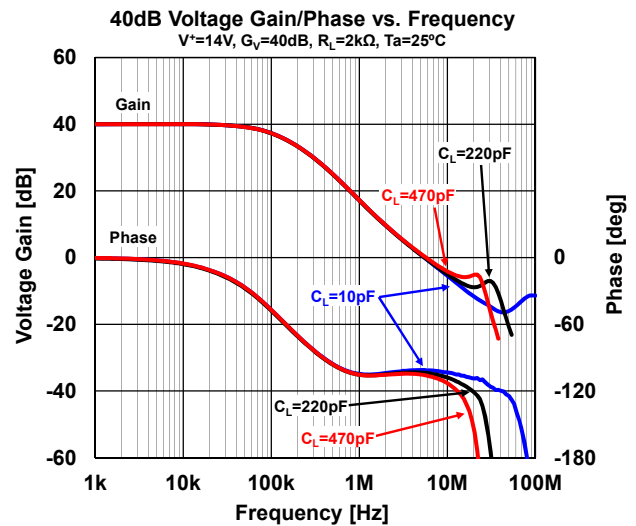
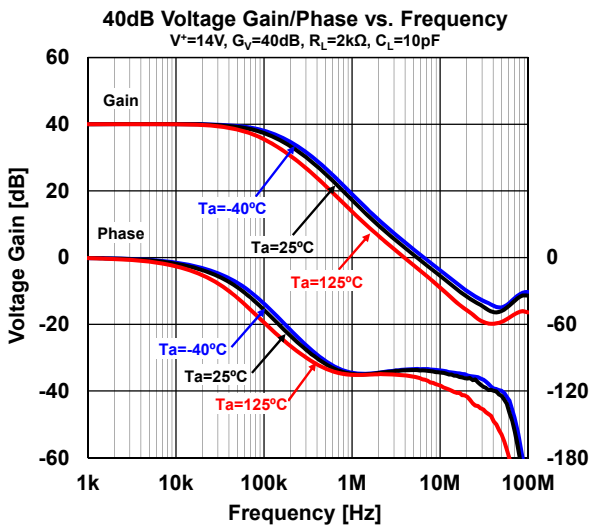
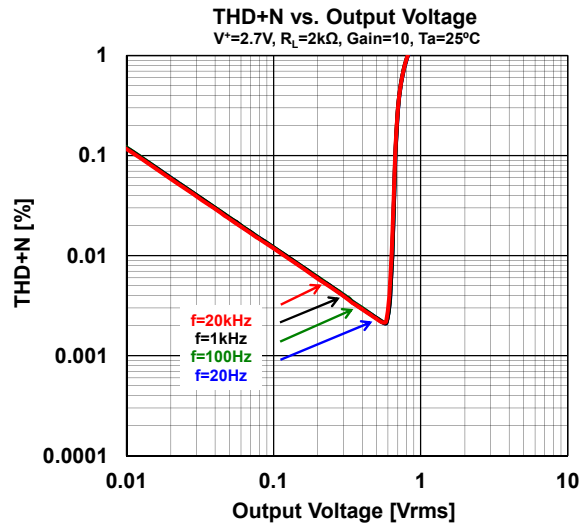
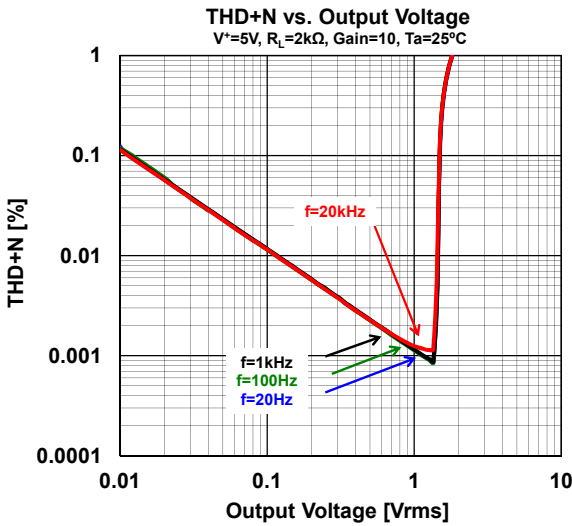
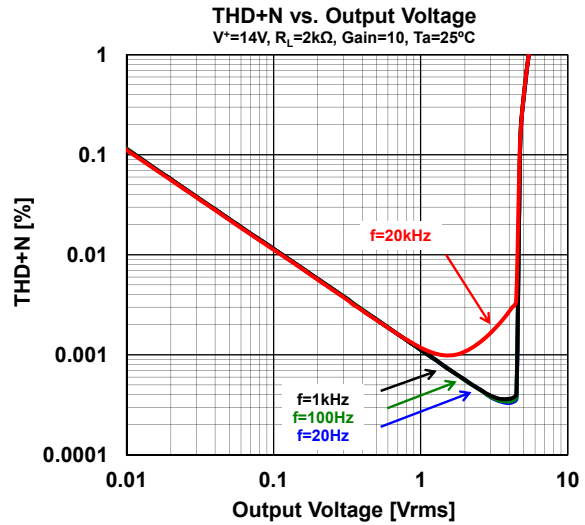
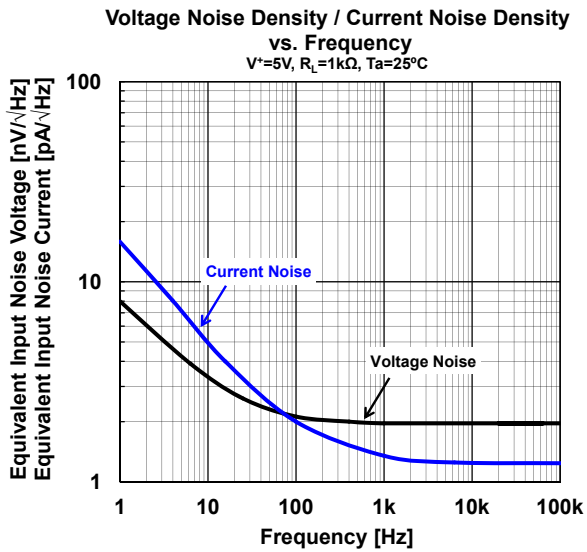

■ TYPICAL CHARACTERISTICS ( $V^- = 0V$ ,  $V_{CM} = V^+ / 2$ , unless otherwise specified)

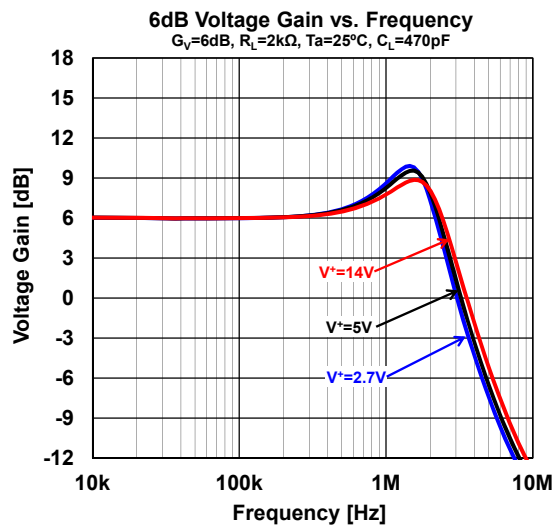
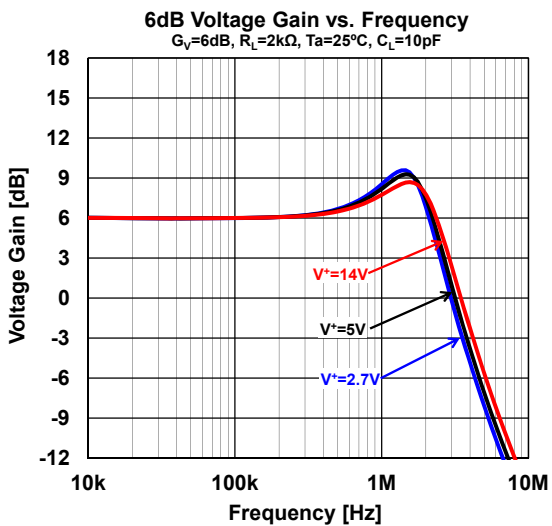
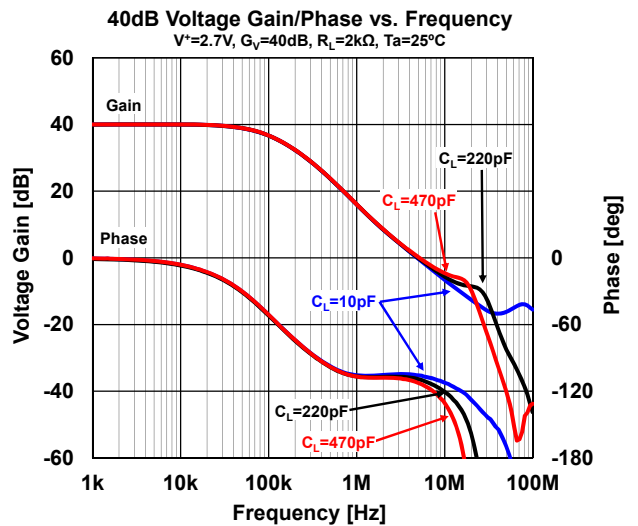
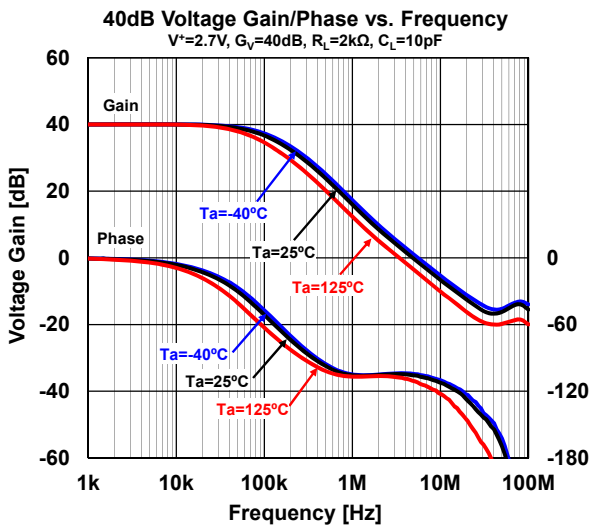
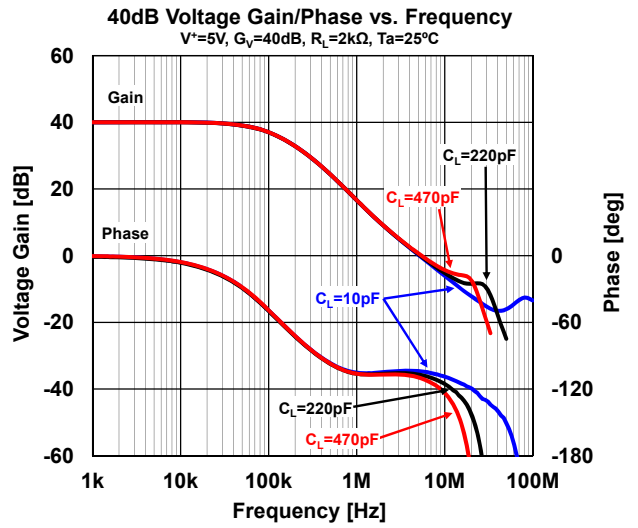
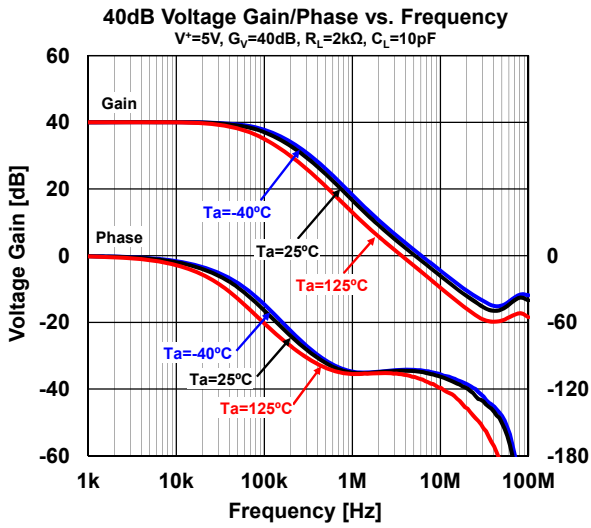

# MUSES8832

## ■ TYPICAL CHARACTERISTICS ( $V^- = 0V$ , $V_{CM} = V^+ / 2$ , unless otherwise specified)

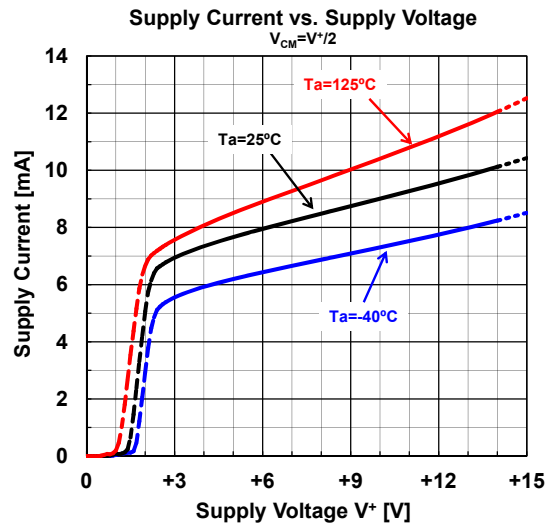
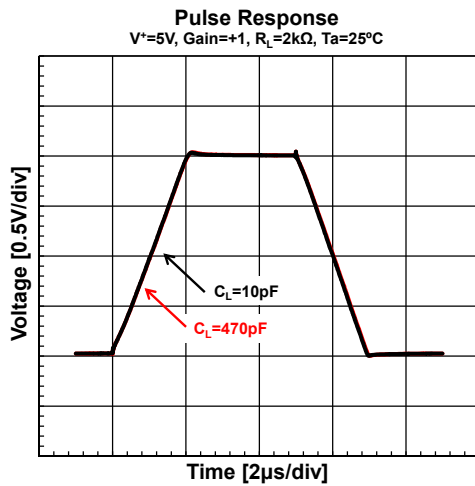
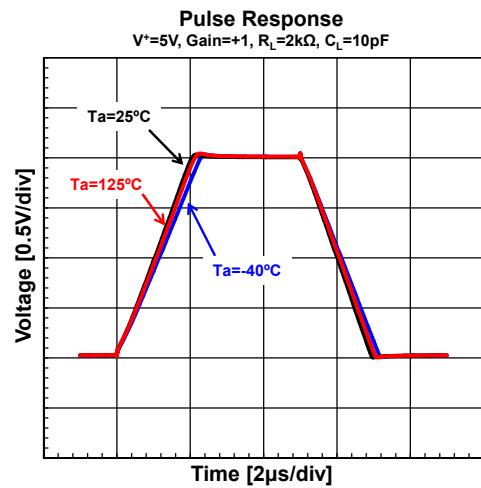
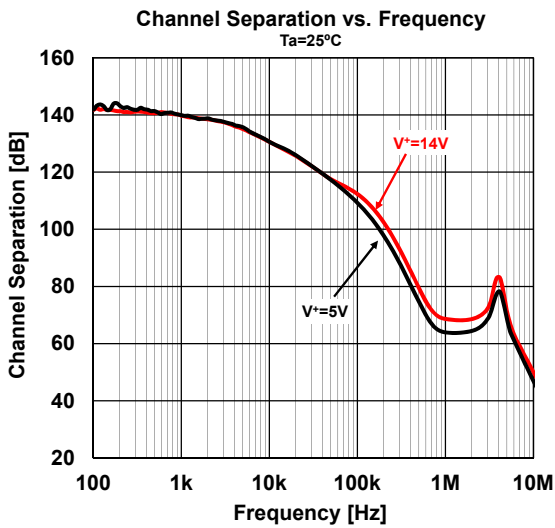
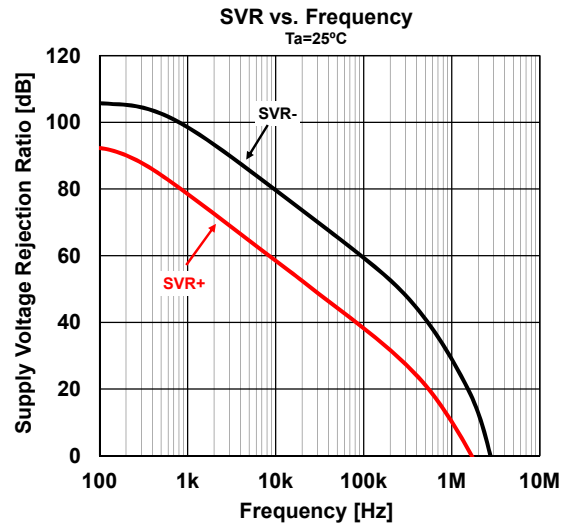
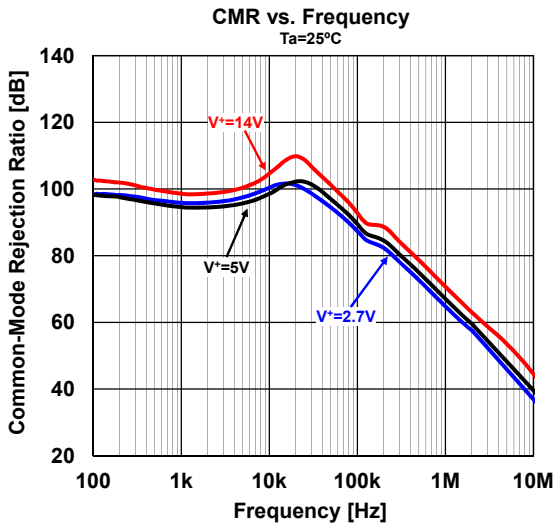

■ TYPICAL CHARACTERISTICS ( $V^- = 0V$ ,  $V_{CM} = V^+ / 2$ , unless otherwise specified)

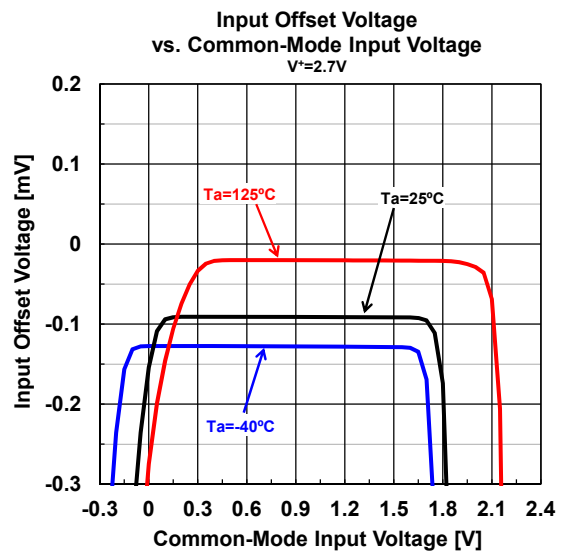
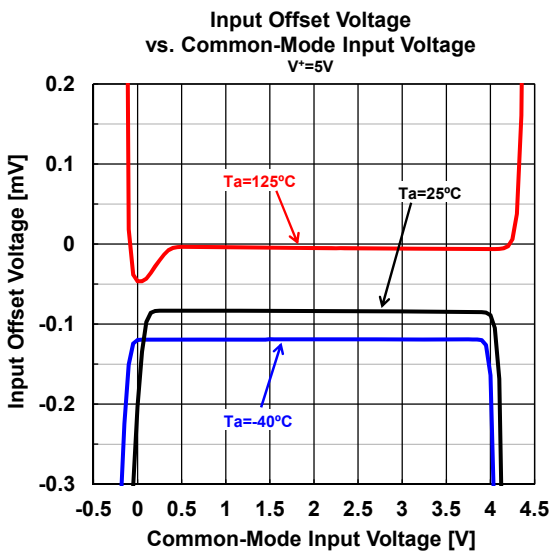
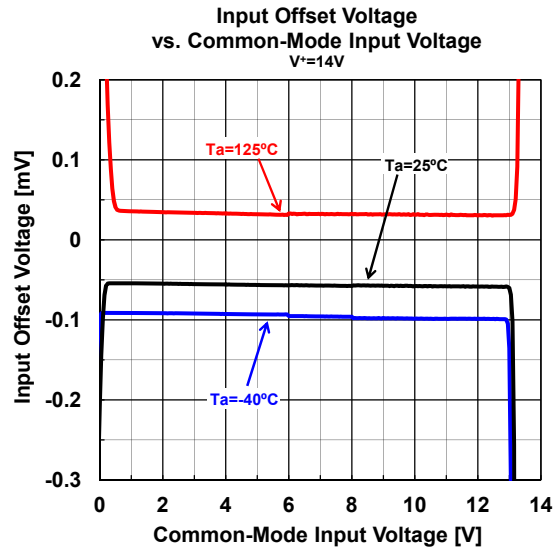
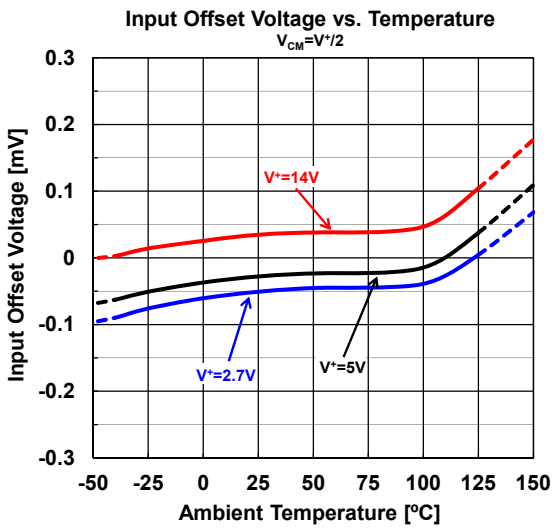
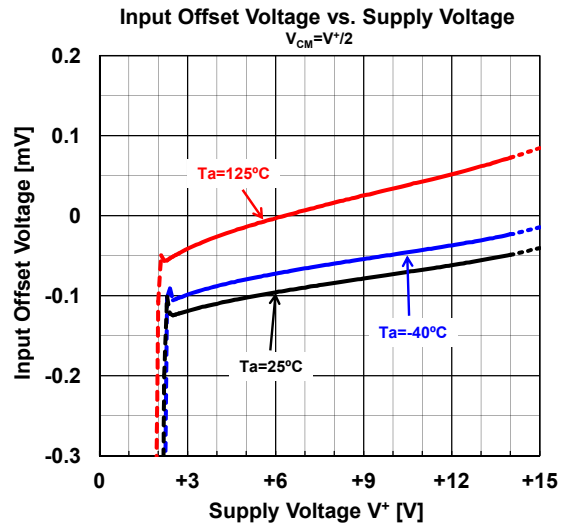
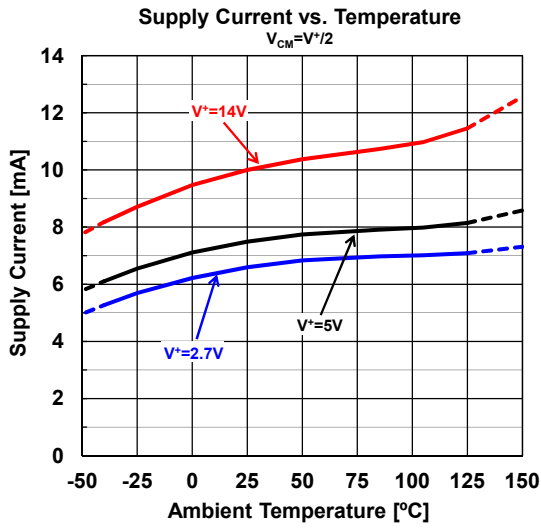

# MUSES8832

## ■ TYPICAL CHARACTERISTICS ( $V^- = 0V$ , $V_{CM} = V^+ / 2$ , unless otherwise specified)

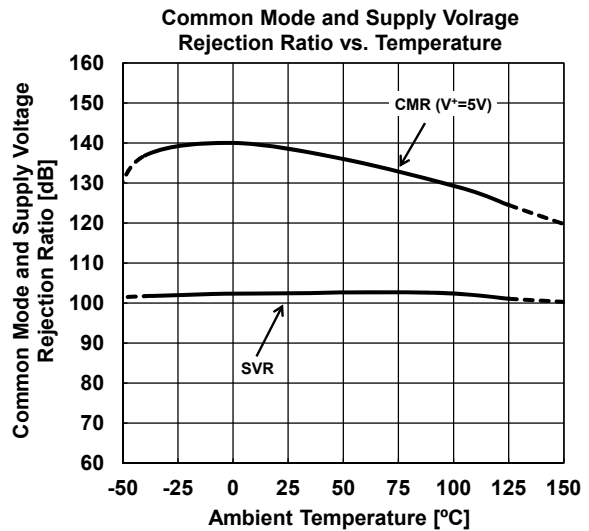
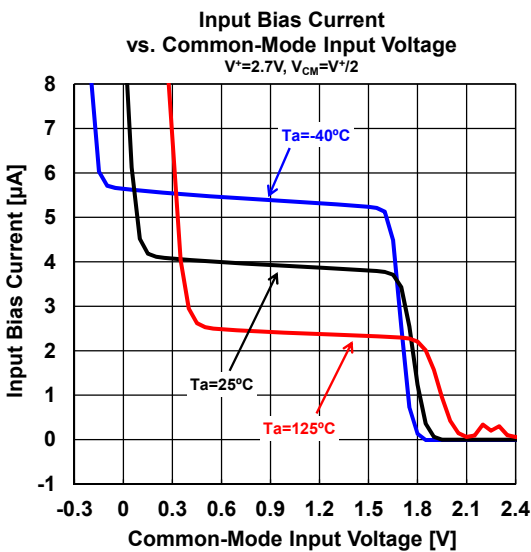
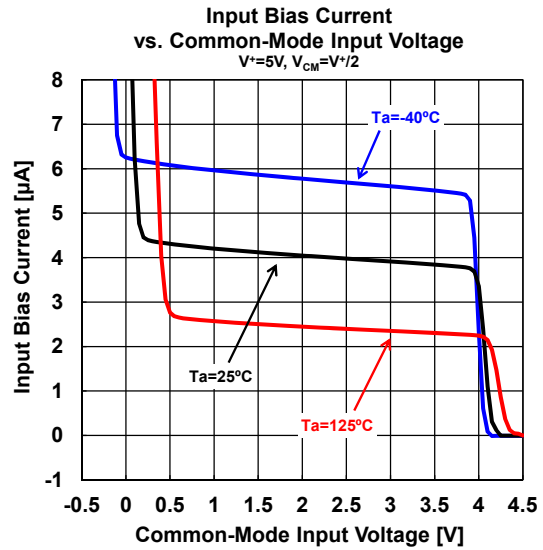
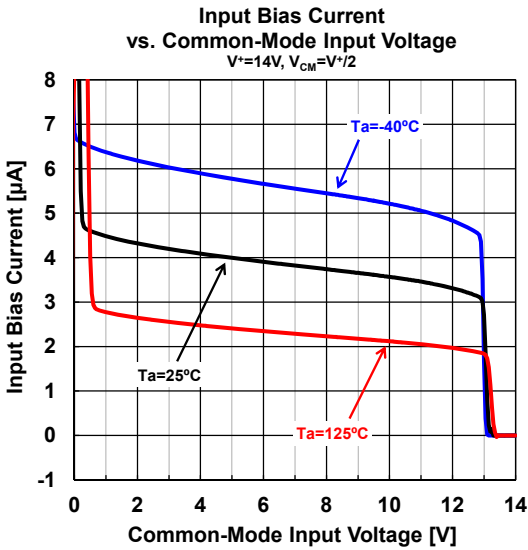
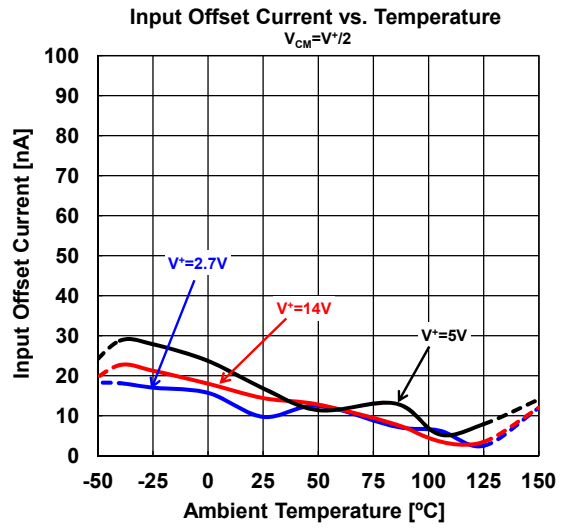
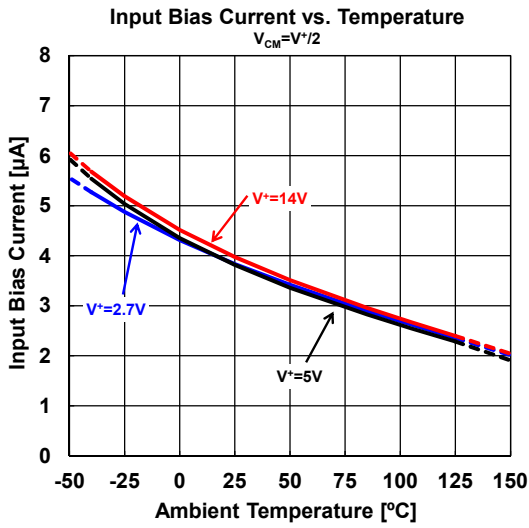



■ TYPICAL CHARACTERISTICS ( $V^- = 0V$ ,  $V_{CM} = V^+ / 2$ , unless otherwise specified)

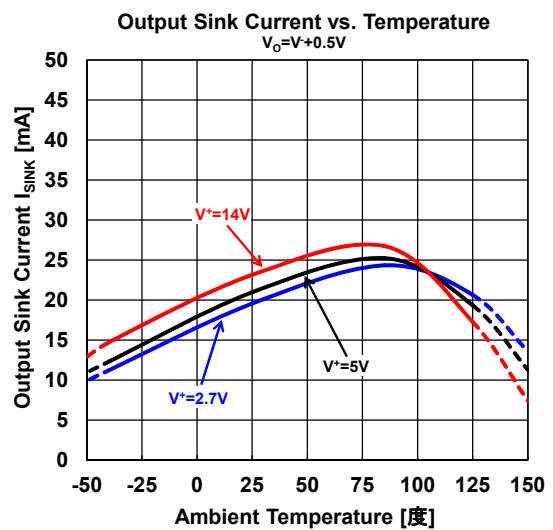
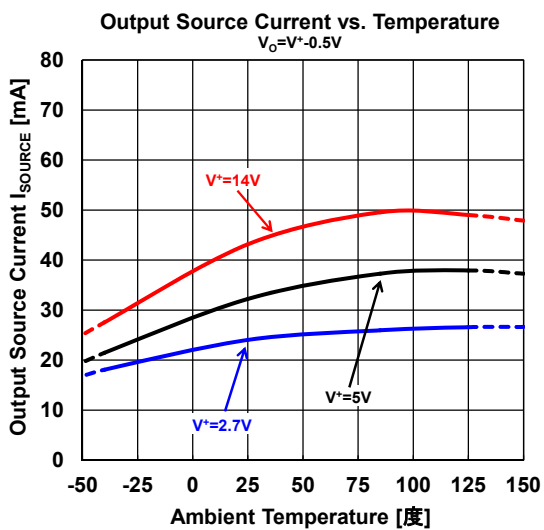
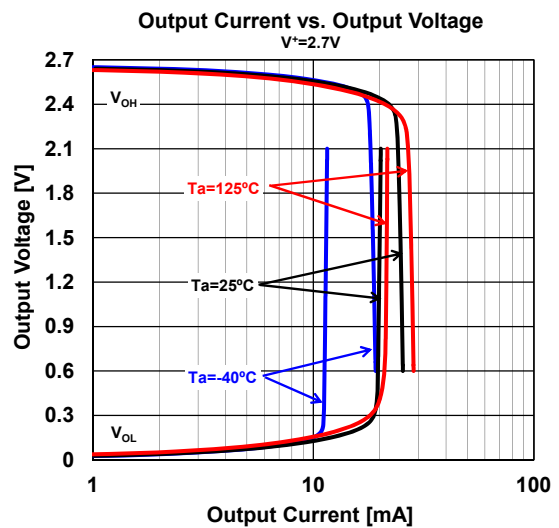
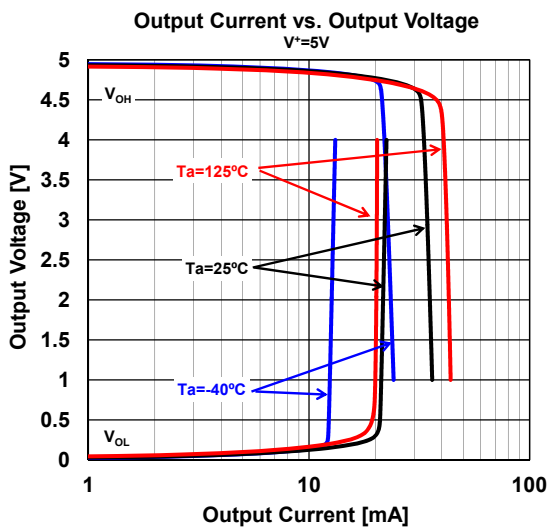
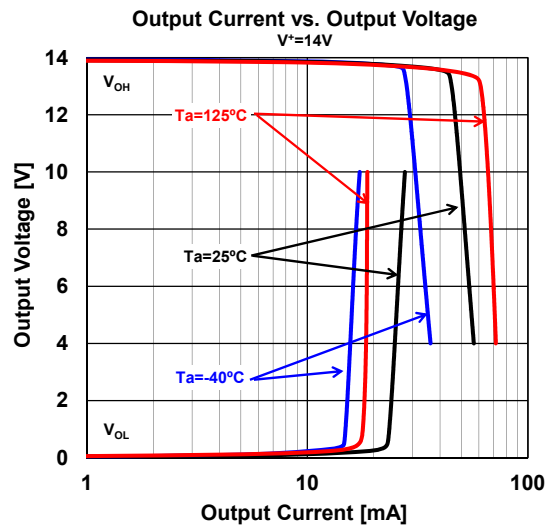
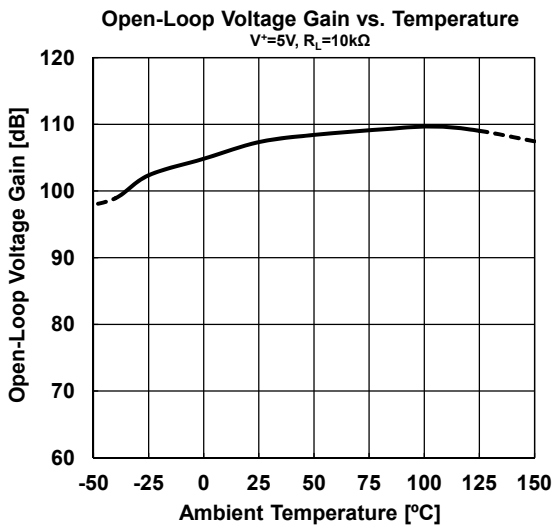

# MUSES8832

## ■ TYPICAL CHARACTERISTICS ( $V^- = 0V$ , $V_{CM} = V^+ / 2$ , unless otherwise specified)

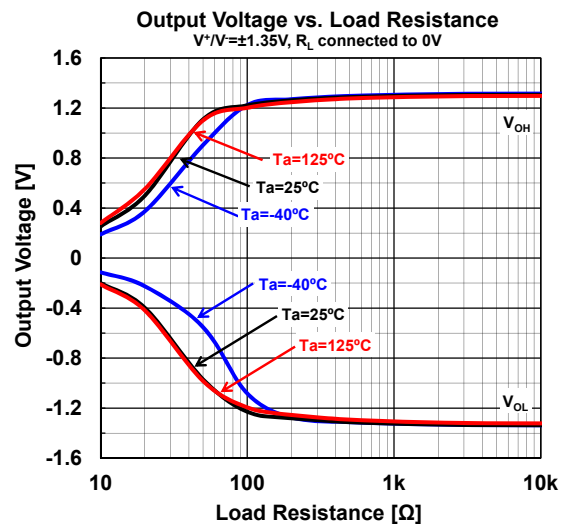
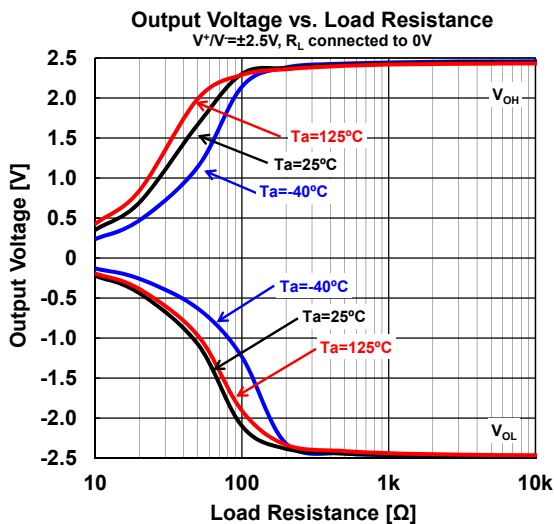
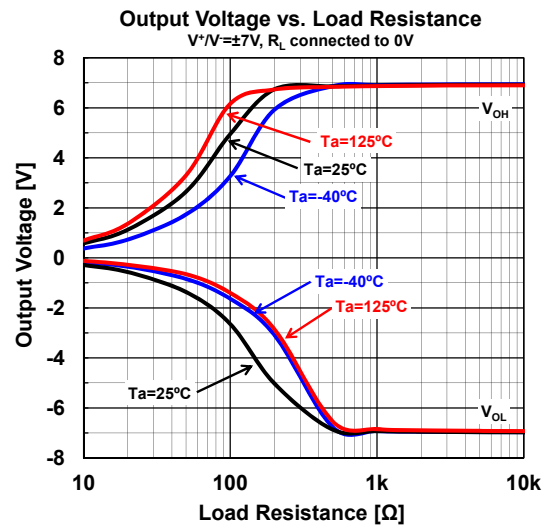
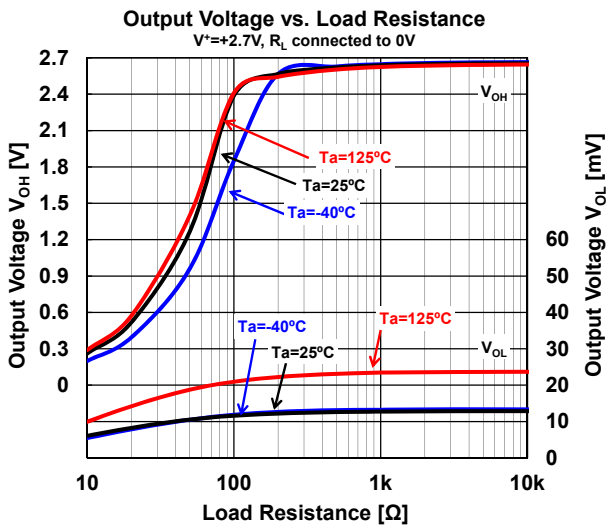
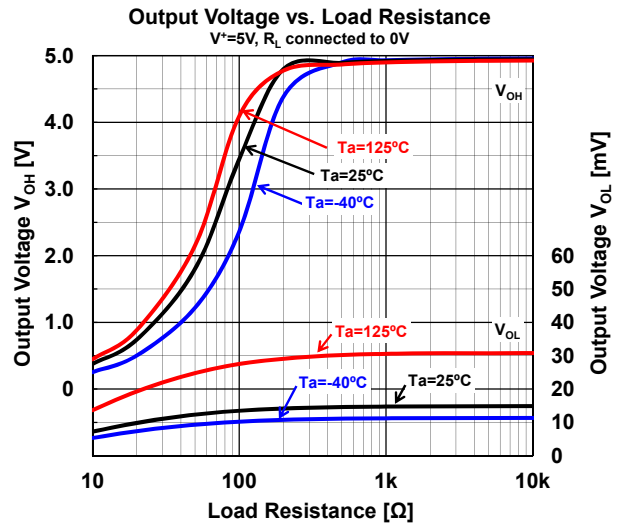
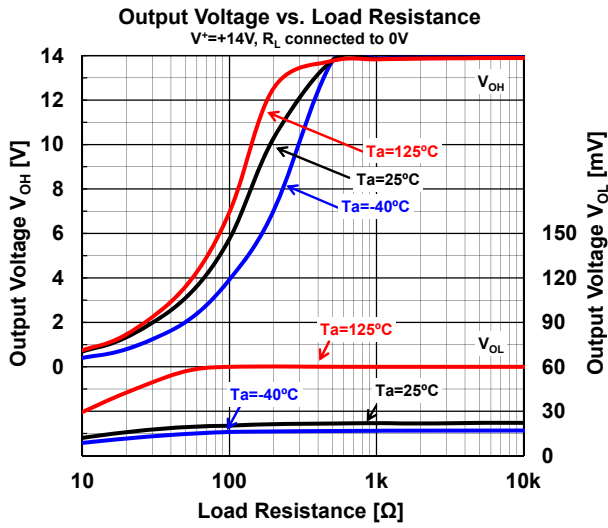

## ■ MEMO

[CAUTION]  
The specifications on this databook are only given for information, without any guarantee as regards either mistakes or omissions. The application circuits in this databook are described only to show representative usages of the product and not intended for the guarantee or permission of any right including the industrial rights.

# Mouser Electronics

Authorized Distributor

Click to View Pricing, Inventory, Delivery & Lifecycle Information:

[NJR:](#)

[MUSES8832E](#) [MUSES8832VA3](#)



Компания «ЭлектроПласт» предлагает заключение долгосрочных отношений при поставках импортных электронных компонентов на взаимовыгодных условиях!

Наши преимущества:

- Оперативные поставки широкого спектра электронных компонентов отечественного и импортного производства напрямую от производителей и с крупнейших мировых складов;
- Поставка более 17-ти миллионов наименований электронных компонентов;
- Поставка сложных, дефицитных, либо снятых с производства позиций;
- Оперативные сроки поставки под заказ (от 5 рабочих дней);
- Экспресс доставка в любую точку России;
- Техническая поддержка проекта, помощь в подборе аналогов, поставка прототипов;
- Система менеджмента качества сертифицирована по Международному стандарту ISO 9001;
- Лицензия ФСБ на осуществление работ с использованием сведений, составляющих государственную тайну;
- Поставка специализированных компонентов (Xilinx, Altera, Analog Devices, Intersil, Interpoint, Microsemi, Aeroflex, Peregrine, Syfer, Eurofarad, Texas Instrument, Miteq, Cobham, E2V, MA-COM, Hittite, Mini-Circuits, General Dynamics и др.);

Помимо этого, одним из направлений компании «ЭлектроПласт» является направление «Источники питания». Мы предлагаем Вам помощь Конструкторского отдела:

- Подбор оптимального решения, техническое обоснование при выборе компонента;
- Подбор аналогов;
- Консультации по применению компонента;
- Поставка образцов и прототипов;
- Техническая поддержка проекта;
- Защита от снятия компонента с производства.



#### Как с нами связаться

**Телефон:** 8 (812) 309 58 32 (многоканальный)

**Факс:** 8 (812) 320-02-42

**Электронная почта:** [org@eplast1.ru](mailto:org@eplast1.ru)

**Адрес:** 198099, г. Санкт-Петербург, ул. Калинина, дом 2, корпус 4, литера А.