

---

### 600 mA PWM/VFM Step-Down DC/DC Converter with Synchronous Rectifier

---

NO.EA-259-150130

#### OUTLINE

The RP504x is a low supply current CMOS-based PWM/VFM step-down DC/DC converter with synchronous rectifier featuring 600 mA<sup>\*1</sup> output current. Internally, a single converter consists of an oscillator, a reference voltage unit, an error amplifier, a switching control circuit, a mode control circuit (RP504xxx1A/D), a soft-start circuit, a Latch-type protection circuit, an under voltage lockout (UVLO) circuit and switching transistors.

The RP504x is employing synchronous rectification for improving the efficiency of rectification by replacing diodes with built-in switching transistors. Using synchronous rectification not only increases circuit performance but also allows a design to reduce parts count.

Power controlling method can be selected from forced PWM control type or PWM/VFM auto switching control type by inputting a signal to the MODE pin. In low output current, forced PWM control switches at fixed frequency rate in order to reduce noise. Likewise, in low output current, PWM/VFM auto switching control automatically switches from PWM mode to VFM mode in order to achieve high efficiency.

Output voltage is internally fixed type which allows output voltages that range from 0.8 V to 3.3 V in 0.1 V step. The output voltage accuracy is as high as  $\pm 1.5\%$  or  $\pm 18$  mV.

Protection circuits included in the RP504x are overcurrent protection circuit and latch type protection circuit. Overcurrent protection circuit supervises the inductor peak current in each switching cycle, and if the current exceeds the  $I_{LX}$  current limit ( $I_{LXLIM}$ ), it turns off P-channel Tr. Latch type protection circuit latches the built-in driver to the OFF state and stops the operation of the step-down DC/DC converter if the overcurrent status continues or  $V_{OUT}$  continues being the half of the setting voltage for equal or longer than protection delay time ( $t_{prot}$ ). To cancel the latch type protection circuit, select the standby mode or the active mode with the CE pin, or drop the power supply voltage below the UVLO detector threshold.

The RP504x is offered in 6-pin DFN(PLP)1216-6F, 6-pin DFN1616-6B and 5-pin SOT-23-5 packages which achieve the smallest possible footprint solution on boards where area is limited.

<sup>\*1</sup> This is an approximate value. The output current is dependent on conditions and external components.

## FEATURES

- Supply Current ..... Typ. 25  $\mu$ A in VFM mode without any load
- Standby Current..... Max. 5  $\mu$ A
- Input Voltage Range ..... 2.3 V to 5.5 V ( $V_{OUT} \geq 1.0$  V)
- Output Voltage Range..... 0.8 V to 3.3 V in 0.1 V step
- Output Voltage Accuracy.....  $\pm 1.5\%$  ( $V_{OUT} \geq 1.2$  V),  $\pm 18$  mV ( $V_{OUT} < 1.2$  V)
- Temperature-Drift Coefficient of Output Voltage ... Typ.  $\pm 40$  ppm/ $^{\circ}$ C
- Oscillator Frequency ..... Typ. 2.25 MHz
- Oscillator Maximum Duty Cycle ..... Min. 100%
- Built-in Driver ON Resistance ..... Typ. Pch. 0.34  $\Omega$ , Nch. 0.43  $\Omega$  ( $V_{IN} = 3.6$  V)
- UVLO Detector Threshold..... Typ. 2.0 V
- Soft Start Time ..... Typ. 0.15 ms
- Lx Current Limit..... Typ. 900 mA
- Latch-type Protection Circuit..... Typ. 1.5 ms
- Auto-discharge Function ..... Only for RP504xxxxD
- Power Controlling Method..... forced PWM control or PWM/VFM auto switching control
- MODE Pin<sup>\*1</sup> ..... “H”: forced PWM control,  
“L”: PWM/VFM auto switching control
- Package<sup>\*1</sup> ..... DFN1616-6B, DFN(PLP)1216-6F, SOT-23-5

<sup>\*1</sup> DFN(PLP)1216-6F, DFN1616-6B: forced PWM control by pulling MODE pin “H” or PWM/VFM auto switching control by pulling MODE pin “L”

SOT-23-5: forced PWM control for RP504xxxxC and PWM/VFM auto switching control for RP504xxxxB

## APPLICATIONS

- Power source for battery-powered equipment.
- Power source for hand-held communication equipment, cameras, VCRs, camcorders.
- Power source for HDD, portable equipment.

**BLOCK DIAGRAMS**



**RP504xxxxA Block Diagram**



**RP504xxxxB Block Diagram**



RP504xxxxC Block Diagram



RP504xxxxD Block Diagram

## SELECTION GUIDE

The set output voltage, the package type, the MODE control pin function and the auto-discharge\*<sup>1</sup> function are user-selectable options.

Product Name	Package	Quantity per Reel	Pb Free	Halogen Free
RP504Kxx1\$-E2	DFN(PLP)1216-6F	5,000 pcs	Yes	Yes
RP504Lxx1\$-TR	DFN1616-6B	5,000 pcs	Yes	Yes
RP504Nxx1\$-TR-FE	SOT-23-5	3,000 pcs	Yes	Yes

xx: Specify the set output voltage ( $V_{SET}$ ) within the range of 0.8 V(08) to 3.3 V(33) in 0.1 V steps.  
Refer to the section of *PACKAGE INFORMATION* for detailed information.

\$: Specify the package type, the MODE control pin function and the auto-discharge function.

\$	Package	MODE Control Pin Function		Auto-discharge Function
		MODE Pin	Power Controlling Method	
A	DFN1616-6B	Yes	“H”: forced PWM “L”: PWM/VFM auto switching control	No
	DFN(PLP)1216-6F			
B	SOT-23-5	No	PWM/VFM auto switching control	No
C	SOT-23-5	No	forced PWM control	No
D	DFN1616-6B	Yes	“H”: forced PWM control “L”: PWM/VFM auto switching control	Yes
	DFN(PLP)1216-6F			

\*<sup>1</sup> Auto-discharge function quickly lowers the output voltage to 0 V, when the chip enable signal is switched from the active mode to the standby mode, by releasing the electrical charge accumulated in the external capacitor.

\*<sup>2</sup> 0.05 V step is also available as a custom code.

## PIN DESCRIPTION



DFN(PLP)1216-6F Pin Configurations    DFN1616-6B Pin Configurations    SOT-23-5 Pin Configurations

### RP504Kxx1A, RP504Kxx1D: DFN(PLP)1216-6F Pin Description

Pin No.	Symbol	Description
1	V <sub>IN</sub>	Input Pin
2	MODE	Mode Control Pin ("H": forced PWM control, "L": PWM/VFM auto switching control)
3	CE	Chip Enable Pin (Active-high)
4	V <sub>OUT</sub>	Output Pin
5	GND	Ground Pin
6	L <sub>x</sub>	L <sub>x</sub> Switching Pin

### RP504Lxx1A, RP504Lxx1D: DFN1616-6B Pin Description

Pin No.	Symbol	Description
1	CE	Chip Enable Pin (Active-high)
2	MODE	Mode Control Pin ("H": forced PWM control, "L": PWM/VFM auto switching control)
3	V <sub>IN</sub>	Input Pin
4	L <sub>x</sub>	L <sub>x</sub> Switching Pin
5	GND	Ground Pin
6	V <sub>OUT</sub>	Output Pin

\* The tab on the bottom of the package enhances thermal performance and is electrically connected to GND (substrate level). It is recommended that the tab be connected to the ground plane on the board. If not, the tab can be left open.

### RP504Nxx1B, RP504Nxx1C: SOT-23-5 Pin Description

Pin No.	Symbol	Description
1	V <sub>OUT</sub>	Output Pin
2	GND	Ground Pin
3	L <sub>x</sub>	L <sub>x</sub> Switching Pin
4	V <sub>IN</sub>	Input Pin
5	CE	Chip Enable Pin (Active-high)

## ABSOLUTE MAXIMUM RATINGS

### Absolute Maximum Ratings

(GND = 0 V)

Symbol	Item	Rating	Unit
$V_{IN}$	$V_{IN}$ Input Voltage	-0.3 to 6.5	V
$V_{LX}$	$L_X$ Pin Voltage	-0.3 to $V_{IN} + 0.3$	V
$V_{CE}$	CE Pin Input Voltage	-0.3 to 6.5	V
$V_{MODE}$	Mode Control Pin Voltage	-0.3 to 6.5	V
$V_{OUT}$	$V_{OUT}$ Pin Voltage	-0.3 to 6.5	V
$I_{LX}$	$L_X$ Pin Output Current	900	mA
$P_D$	Power Dissipation (Standard Land Pattern)* <sup>1</sup>	DFN(PLP)1216-6F	385
		DFN1616-6B	640
		SOT-23-5	420
$T_a$	Operating Temperature Range	-40 to 85	°C
$T_{stg}$	Storage Temperature Range	-55 to 125	°C

\*<sup>1</sup> Refer to *PACKAGE INFORMATION* for detailed information.

### ABSOLUTE MAXIMUM RATINGS

Electronic and mechanical stress momentarily exceeded absolute maximum ratings may cause the permanent damages and may degrade the life time and safety for both device and system using the device in the field. The functional operation at or over these absolute maximum ratings is not assured.

### RECOMMENDED OPERATING CONDITIONS (ELECTRICAL CHARACTERISTICS)

All of electronic equipment should be designed that the mounted semiconductor devices operate within the recommended operating conditions. The semiconductor devices cannot operate normally over the recommended operating conditions, even if when they are used over such conditions by momentary electronic noise or surge. And the semiconductor devices may receive serious damage when they continue to operate over the recommended operating conditions.

## ELECTRICAL CHARACTERISTICS

### RP504xxx1A, RP504xxx1D Electrical Characteristics

(Ta = 25°C)

Symbol	Item	Conditions	Min.	Typ.	Max.	Unit	
V <sub>IN</sub>	Operating Input Voltage	V <sub>OUT</sub> ≥ 1.0	2.3		5.5	V	
		V <sub>OUT</sub> < 1.0	2.3		4.5		
V <sub>OUT</sub>	Output Voltage	V <sub>IN</sub> = V <sub>CE</sub> = 3.6 V or V <sub>SET</sub> +1 V	V <sub>OUT</sub> ≥ 1.2 V	x0.985		x1.015	V
			V <sub>OUT</sub> < 1.2 V	-0.018		+0.018	
ΔV <sub>OUT</sub> /ΔTa	Output Voltage Temperature Coefficient	-40°C ≤ Ta ≤ 85°C		±40		ppm/°C	
fosc	Oscillator Frequency	V <sub>IN</sub> = V <sub>CE</sub> = 3.6 V or V <sub>SET</sub> +1 V	1.95	2.25	2.55	MHz	
I <sub>DD1</sub>	Supply Current 1	V <sub>IN</sub> = V <sub>CE</sub> = 5.5 V, V <sub>OUT</sub> = V <sub>SET</sub> × 0.8		400	800	μA	
I <sub>DD2</sub>	Supply Current 2	V <sub>IN</sub> = V <sub>CE</sub> = V <sub>OUT</sub> = 5.5 V	V <sub>MODE</sub> = 0 V		25	40	μA
			V <sub>MODE</sub> = 5.5 V		400	800	
I <sub>standby</sub>	Standby Current	V <sub>IN</sub> = 5.5 V, V <sub>CE</sub> = 0 V		0	5	μA	
I <sub>CEH</sub>	CE "H" Input Voltage	V <sub>IN</sub> = V <sub>CE</sub> = 5.5 V	-1	0	1	μA	
I <sub>CEL</sub>	CE "L" Input Voltage	V <sub>IN</sub> = 5.5 V, V <sub>CE</sub> = 0 V	-1	0	1	μA	
I <sub>MODEH</sub>	Mode "H" Input Current	V <sub>IN</sub> = V <sub>MODE</sub> = 5.5 V	-1	0	1	μA	
I <sub>MODEL</sub>	Mode "L" Input Current	V <sub>IN</sub> = 5.5 V, V <sub>MODE</sub> = 0 V	-1	0	1	μA	
I <sub>VOUTH</sub>	V <sub>OUT</sub> "H" Input Current <sup>*1</sup>	V <sub>IN</sub> = V <sub>OUT</sub> = 5.5 V, V <sub>CE</sub> = 0 V	-1	0	1	μA	
I <sub>VOUTL</sub>	V <sub>OUT</sub> "L" Input Current	V <sub>IN</sub> = 5.5 V, V <sub>CE</sub> = V <sub>OUT</sub> = 0 V	-1	0	1	μA	
I <sub>LXLEAKH</sub>	Lx Leakage Current "H"	V <sub>IN</sub> = V <sub>LX</sub> = 5.5 V, V <sub>CE</sub> = 0 V	-1	0	5	μA	
I <sub>LXLEAKL</sub>	Lx Leakage Current "L"	V <sub>IN</sub> = 5.5 V, V <sub>CE</sub> = V <sub>LX</sub> = 0 V	-5	0	1	μA	
V <sub>CEH</sub>	CE "H" Input Voltage	V <sub>IN</sub> = 5.5 V	1.0			V	
V <sub>CEL</sub>	CE "L" Input Voltage	V <sub>IN</sub> = 2.3 V			0.4	V	
V <sub>MODEH</sub>	Mode "H" Input Voltage	V <sub>IN</sub> = 5.5 V	1.0			V	
V <sub>MODEL</sub>	Mode "L" Input Voltage	V <sub>IN</sub> = 2.3 V			0.4	V	
R <sub>LOW</sub>	Nch On Resistance <sup>*2</sup>	V <sub>IN</sub> = 3.6 V, V <sub>CE</sub> = 0 V		30		Ω	
R <sub>ONP</sub>	On Resistance of Pch Tr.	V <sub>IN</sub> = 3.6 V, I <sub>LX</sub> = -100 mA		0.34		Ω	
R <sub>ONN</sub>	On Resistance of Nch Tr.	V <sub>IN</sub> = 3.6 V, I <sub>LX</sub> = -100 mA		0.43		Ω	
Maxduty	Oscillator Maximum Duty Cycle		100			%	
tstart	Soft-start Time	V <sub>IN</sub> = V <sub>CE</sub> = 3.6 V or V <sub>SET</sub> +1 V		150	310	μs	
I <sub>LXLIM</sub>	Lx Current Limit	V <sub>IN</sub> = V <sub>CE</sub> = 3.6 V or V <sub>SET</sub> +1 V	700	900		mA	
tprot	Protection Delay Time	V <sub>IN</sub> = V <sub>CE</sub> = 3.6 V or V <sub>SET</sub> +1 V	0.5	1.5	5	ms	
V <sub>UVLO1</sub>	UVLO Detector Threshold	V <sub>IN</sub> = V <sub>CE</sub>	1.9	2.0	2.1	V	
V <sub>UVLO2</sub>	UVLO Released Voltage	V <sub>IN</sub> = V <sub>CE</sub>	2.0	2.1	2.2	V	

All test items listed under *ELECTRICAL CHARACTERISTICS* are done under the pulse load condition (T<sub>j</sub> ≈ Ta = 25°C) except Output Voltage Temperature Coefficient.

Test circuit is "OPEN LOOP" and AGND = PGND = 0 V unless otherwise specified.

\*1 Only for RP504xxx1A/B/C with no auto-discharge

\*2 Only for RP504xxx1D with auto-discharge



RP504xxxxB, RP504xxxxC Electrical Characteristics

(Ta = 25°C)

Symbol	Item	Conditions	Min.	Typ.	Max.	Unit	
V <sub>IN</sub>	Operating Input Voltage	V <sub>OUT</sub> ≥ 1.0	2.3		5.5	V	
		V <sub>OUT</sub> < 1.0	2.3		4.5		
V <sub>OUT</sub>	Output Voltage	V <sub>IN</sub> = V <sub>CE</sub> = 3.6 V or V <sub>SET</sub> +1 V	V <sub>OUT</sub> ≥ 1.2 V	x0.985		x1.015	V
			V <sub>OUT</sub> < 1.2 V	-0.018		+0.018	
ΔV <sub>OUT</sub> /ΔTa	Output Voltage Temperature Coefficient	-40°C ≤ Ta ≤ 85°C		±40		ppm/°C	
fosc	Oscillator Frequency	V <sub>IN</sub> = V <sub>CE</sub> = 3.6 V or V <sub>SET</sub> +1 V	1.95	2.25	2.55	MHz	
I <sub>DD1</sub>	Supply Current 1	V <sub>IN</sub> = V <sub>CE</sub> = 5.5 V, V <sub>OUT</sub> = V <sub>SET</sub> × 0.8		400	800	μA	
I <sub>DD2</sub>	Supply Current 2	V <sub>IN</sub> = V <sub>CE</sub> = V <sub>OUT</sub> = 5.5 V	RP504xxx1B	25	40	μA	
			RP504xxx1C	400	800		
Istandby	Standby Current	V <sub>IN</sub> = 5.5 V, V <sub>CE</sub> = 0 V		0	5	μA	
I <sub>CEH</sub>	CE "H" Input Voltage	V <sub>IN</sub> = V <sub>CE</sub> = 5.5 V	-1	0	1	μA	
I <sub>CEL</sub>	CE "L" Input Voltage	V <sub>IN</sub> = 5.5 V, V <sub>CE</sub> = 0 V	-1	0	1	μA	
I <sub>VOUTH</sub>	V <sub>OUT</sub> "H" Input Current	V <sub>IN</sub> = V <sub>OUT</sub> = 5.5 V, V <sub>CE</sub> = 0 V	-1	0	1	μA	
I <sub>VOU TL</sub>	V <sub>OUT</sub> "L" Input Current	V <sub>IN</sub> = 5.5 V, V <sub>CE</sub> = V <sub>OUT</sub> = 0 V	-1	0	1	μA	
I <sub>LXLEAKH</sub>	Lx Leakage Current "H"	V <sub>IN</sub> = V <sub>LX</sub> = 5.5 V, V <sub>CE</sub> = 0 V	-1	0	5	μA	
I <sub>LXLEAKL</sub>	Lx Leakage Current "L"	V <sub>IN</sub> = 5.5 V, V <sub>CE</sub> = V <sub>LX</sub> = 0 V	-5	0	1	μA	
V <sub>CEH</sub>	CE "H" Input Voltage	V <sub>IN</sub> = 5.5 V	1.0			V	
V <sub>CEL</sub>	CE "L" Input Voltage	V <sub>IN</sub> = 2.3 V			0.4	V	
R <sub>ONP</sub>	On Resistance of Pch Tr.	V <sub>IN</sub> = 3.6 V, I <sub>LX</sub> = -100 mA		0.34		Ω	
R <sub>ONN</sub>	On Resistance of Nch Tr.	V <sub>IN</sub> = 3.6 V, I <sub>LX</sub> = -100 mA		0.43		Ω	
Maxduty	Oscillator Maximum Duty Cycle		100			%	
tstart	Soft-start Time	V <sub>IN</sub> = V <sub>CE</sub> = 3.6 V or V <sub>SET</sub> +1 V		150	310	μs	
I <sub>LXLIM</sub>	Lx Current Limit	V <sub>IN</sub> = V <sub>CE</sub> = 3.6 V or V <sub>SET</sub> +1 V	700	900		mA	
tprot	Protection Delay Time	V <sub>IN</sub> = V <sub>CE</sub> = 3.6 V or V <sub>SET</sub> +1 V	0.5	1.5	5	ms	
V <sub>UVLO1</sub>	UVLO Detector Threshold	V <sub>IN</sub> = V <sub>CE</sub>	1.9	2.0	2.1	V	
V <sub>UVLO2</sub>	UVLO Released Voltage	V <sub>IN</sub> = V <sub>CE</sub>	2.0	2.1	2.2	V	

All test items listed under *ELECTRICAL CHARACTERISTICS* are done under the pulse load condition (T<sub>j</sub> ≈ Ta = 25°C) except Output Voltage Temperature Coefficient.

Test circuit is "OPEN LOOP" and AGND = PGND = 0 V unless otherwise specified.

## TYPICAL APPLICATION



RP504N Typical Application: MODE Pin not included



RP504K/L Typical Application: MODE Pin included

\*1 MODE = "H": forced PWM control, MODE = "L": PWM/VFM auto switching control

### Recommended Components

Symbol	Capacitance	Type	Manufacturer
C <sub>IN</sub>	2.2 µF	Ceramic Capacitor	C1608JB0J225K(TDK)
	2.2 µF x 2		C1005JB0J225K (TDK) JMK105BJ225MV (Taiyo Yuden)
	4.7 µF		C1005X5R0J475M (TDK) JMK105BJ475MV (Taiyo Yuden)
C <sub>OUT</sub>	4.7 µF	Ceramic Capacitor	C1608JB0J475K (TDK) GRM188B30J475KE18 (Murata)
L	2.2 µH	Inductor	MIPSZ2520D2R2 (FDK) MIPS2520D2R2 (FDK) MLP2520S2R2M (TDK) VLS252010T-2R2M (TDK)

## TECHNICAL NOTES

The performance of power supply circuits using this IC largely depends on the peripheral circuits. Please be very careful when setting the peripheral parts. When designing the peripheral circuits of each part, PCB patterns, and this IC, please do not exceed the rated values (Voltage, Current, Power).

- Ensure the  $V_{IN}$  and GND lines are sufficiently robust. A large switching current flows through the GND lines, the  $V_{DD}$  line, the  $V_{OUT}$  line, an inductor, and  $L_X$ . If their impedance is too high, noise pickup or unstable operation may result. Set the external components as close as possible to the IC and minimize the wiring between the components and the IC, especially between a capacitor ( $C_{IN}$ ) and the  $V_{IN}$  pin. The wiring between  $V_{OUT}$  and load and between L and  $V_{OUT}$  should be separated.
- Choose a low ESR ceramic capacitor. The capacitance of  $C_{IN}$  should be more than or equal to 2.2  $\mu\text{F}$ . The capacitance of a capacitor ( $C_{OUT}$ ) should be between 4.7  $\mu\text{F}$  to 10  $\mu\text{F}$ .
- The Inductance value should be set within the range of 2.2  $\mu\text{H}$  to 4.7  $\mu\text{H}$ . However, the inductance value is limited by output voltage. Refer to the table below. The phase compensation of this IC is designed according to the  $C_{OUT}$  and L values. Choose an inductor that has small DC resistance, has enough allowable current and is hard to cause magnetic saturation. If the inductance value of an inductor is extremely small, the peak current of  $L_X$  may increase. The increased  $L_X$  peak current reaches "L<sub>X</sub> limit current" to trigger overcurrent protection circuit even if the load current is less than 600 mA.
- Overcurrent protection circuit, Latch-type protection circuit may be affected by self-heating and heat radiation environment.

## OPERATION OF STEP-DOWN CONVERTER AND OUTPUT CURRENT

The step-down DC/DC converter charges energy in the inductor when  $L_x$  Tr. turns “ON”, and discharges the energy from the inductor when  $L_x$  Tr. turns “OFF” and operates with less energy loss, so that a lower output voltage ( $V_{OUT}$ ) than the input voltage ( $V_{IN}$ ) can be obtained. The operation of the step-down DC/DC converter is explained in the following figures.



Figure 1. Basic Circuit



Figure 2. Inductor Current (IL) flowing through Inductor

- Step1.** P-channel Tr. turns “ON” and  $I_L$  ( $i_1$ ) flows,  $L$  is charged with energy. At this moment,  $i_1$  increases from the minimum inductor current ( $I_{Lmin}$ ), which is 0 A, and reaches the maximum inductor current ( $I_{Lmax}$ ) in proportion to the on-time period ( $t_{on}$ ) of P-channel Tr.
- Step2.** When P-channel Tr. turns “OFF”,  $L$  tries to maintain  $I_L$  at  $I_{Lmax}$ , so  $L$  turns N-channel Tr. “ON” and  $I_L$  ( $i_2$ ) flows into  $L$ .
- Step3.**  $i_2$  decreases gradually and reaches  $I_{Lmin}$  after the open-time period ( $t_{open}$ ) of N-channel Tr., and then N-channel Tr. turns “OFF”. This is called discontinuous current mode. As the output current ( $I_{OUT}$ ) increases, the off-time period ( $t_{off}$ ) of P-channel Tr. runs out before  $I_L$  reaches  $I_{Lmin}$ . The next cycle starts, and P-channel Tr. turns “ON” and N-channel Tr. turns “OFF”, which means  $I_L$  starts increasing from  $I_{Lmin}$ . This is called continuous current mode.

In the case of PWM mode,  $V_{OUT}$  is maintained by controlling  $t_{on}$ . During the PWM mode, the oscillator frequency ( $f_{osc}$ ) is constantly maintained.

As shown in Figure 2, when the step-down DC/DC operation is constant,  $I_{Lmin}$  and  $I_{Lmax}$  during  $t_{on}$  of P-channel Tr. would be the same as  $I_{Lmin}$  and  $I_{Lmax}$  during  $t_{off}$  of the P-channel Tr.

The current differential between  $I_{Lmax}$  and  $I_{Lmin}$  is described as  $\Delta I$ .

$$\Delta I = I_{Lmax} - I_{Lmin} = V_{OUT} \times t_{open} / L = (V_{IN} - V_{OUT}) \times t_{on} / L \dots \dots \dots \text{Equation 1}$$

However,

$$T = 1 / f_{osc} = t_{on} + t_{off}$$

$$\text{Duty (\%)} = t_{on} / T \times 100 = t_{on} \times f_{osc} \times 100$$

$$t_{open} \leq t_{off}$$

In Equation 1, “ $V_{OUT} \times t_{open} / L$ ” shows the amount of current change in “OFF” state. Also, “ $(V_{IN} - V_{OUT}) \times t_{on} / L$ ” shows the amount of current change at “ON” state.

## DISCONTINUOUS MODE AND CONTINUOUS MODE

As illustrated in Figure 3., when  $I_{OUT}$  is relatively small,  $t_{open} < t_{off}$ . In this case, the energy charged into L during  $t_{on}$  will be completely discharged during  $t_{off}$ , as a result,  $I_{LMIN} = 0$ . This is called discontinuous mode.

When  $I_{OUT}$  is gradually increased, eventually  $t_{open} = t_{off}$  and when  $I_{OUT}$  is increased further, eventually  $I_{LMIN} > 0$ . This is called continuous mode.



Figure 3. Discontinuous Mode



Figure 4. Continuous Mode

In the continuous mode, the solution of Equation 1 is described as  $t_{onc}$ .

$$t_{onc} = T \times V_{OUT} / V_{IN} \dots\dots\dots \text{Equation 2}$$

When  $t_{on} < t_{onc}$ , it indicates discontinuous mode, and when  $t_{on} = t_{onc}$ , it indicates continuous mode.

## OUTPUT CURRENT AND SELECTION OF EXTERNAL COMPONENTS

The following equations explain the relationship between output current and peripheral components used in the diagrams in *TYPICAL APPLICATIONS*.

Ripple Current P-P value is described as  $I_{RP}$ , ON resistance of P-channel Tr. is described as  $R_{ONP}$ , ON resistance of N-channel Tr. is described as  $R_{ONN}$ , and DC resistor of the inductor is described as  $R_L$ .

$$V_{IN} = V_{OUT} + (R_{ONP} + R_L) \times I_{OUT} + L \times I_{RP} / t_{on} \dots\dots\dots \text{Equation 3}$$

Second, when P-channel Tr. is “OFF” (N-channel Tr. Is “ON”), the following equation is satisfied.

$$L \times I_{RP} / t_{off} = R_{ONN} \times I_{OUT} + V_{OUT} + R_L \times I_{OUT} \dots\dots\dots \text{Equation 4}$$

Put Equation 4 into Equation 3 to solve ON duty of P-channel Tr. ( $D_{ON} = t_{on} / (t_{off} + t_{on})$ ):

$$D_{ON} = (V_{OUT} + R_{ONN} \times I_{OUT} + R_L \times I_{OUT}) / (V_{IN} + R_{ONN} \times I_{OUT} - R_{ONP} \times I_{OUT}) \dots\dots\dots \text{Equation 5}$$

Ripple Current is described as follows:

$$I_{RP} = (V_{IN} - V_{OUT} - R_{ONP} \times I_{OUT} - R_L \times I_{OUT}) \times D_{ON} / f_{osc} / L \dots\dots\dots \text{Equation 6}$$

Peak current that flows through L, and Lx Tr. is described as follows:

$$I_{LXMAX} = I_{OUT} + I_{RP} / 2 \dots\dots\dots \text{Equation 7}$$

Consider  $I_{LXMAX}$  when setting conditions of input and output, as well as selecting the external components. The above calculation formulas are based on the ideal operation of the ICS in continuous mode.

## TIMING CHART

### SOFT-START TIME

#### Starting-up with CE Pin

The IC starts to operate when the CE pin voltage ( $V_{CE}$ ) exceeds the threshold voltage. The threshold voltage is preset between CE “H” input voltage ( $V_{CEH}$ ) and CE “L” input voltage ( $V_{CEL}$ ).

After the start-up of the IC, soft-start circuit starts to operate. Then, after a certain period of time, the reference voltage ( $V_{REF}$ ) in the IC gradually increases up to the specified value.



Soft-start time starts when soft-start circuit is activated, and ends when the reference voltage reaches the specified voltage.

Soft start time is not always equal to the turn-on speed of the step-down DC/DC converter. Please note that the turn-on speed could be affected by the power supply capacity, the output current, the inductance value and the  $C_{OUT}$  value.

#### Starting-up with Power Supply

After the power-on, when  $V_{IN}$  exceeds the UVLO released voltage ( $V_{UVLO2}$ ), the IC starts to operate. Then, soft-start circuit starts to operate and after a certain period of time,  $V_{REF}$  gradually increases up to the specified value. Soft-start time starts when soft-start circuit is activated, and ends when  $V_{REF}$  reaches the specified voltage.



Please note that the turn-on speed of  $V_{OUT}$  could be affected by the power supply capacity, the output current, the inductance value, the  $C_{OUT}$  value and the turn-on speed of  $V_{IN}$  determined by  $C_{IN}$ .

**Under Voltage Lockout (UVLO) Circuit**

If  $V_{IN}$  becomes lower than  $V_{SET}$ , the step-down DC/DC converter stops the switching operation and ON duty becomes 100%, and then  $V_{OUT}$  gradually drops according to  $V_{IN}$ .

If the  $V_{IN}$  becomes lower than the UVLO detector threshold ( $V_{UVLO1}$ ), the UVLO circuit starts to operate,  $V_{REF}$  stops, and P-channel and N-channel built-in switch transistors turn "OFF". As a result,  $V_{OUT}$  drops according to the  $C_{OUT}$  capacitance value and the load.

To restart the operation,  $V_{IN}$  needs to be higher than  $V_{UVLO2}$ . The timing chart below shows the voltage shifts of  $V_{REF}$ ,  $V_{LX}$  and  $V_{OUT}$  when  $V_{IN}$  value is varied.

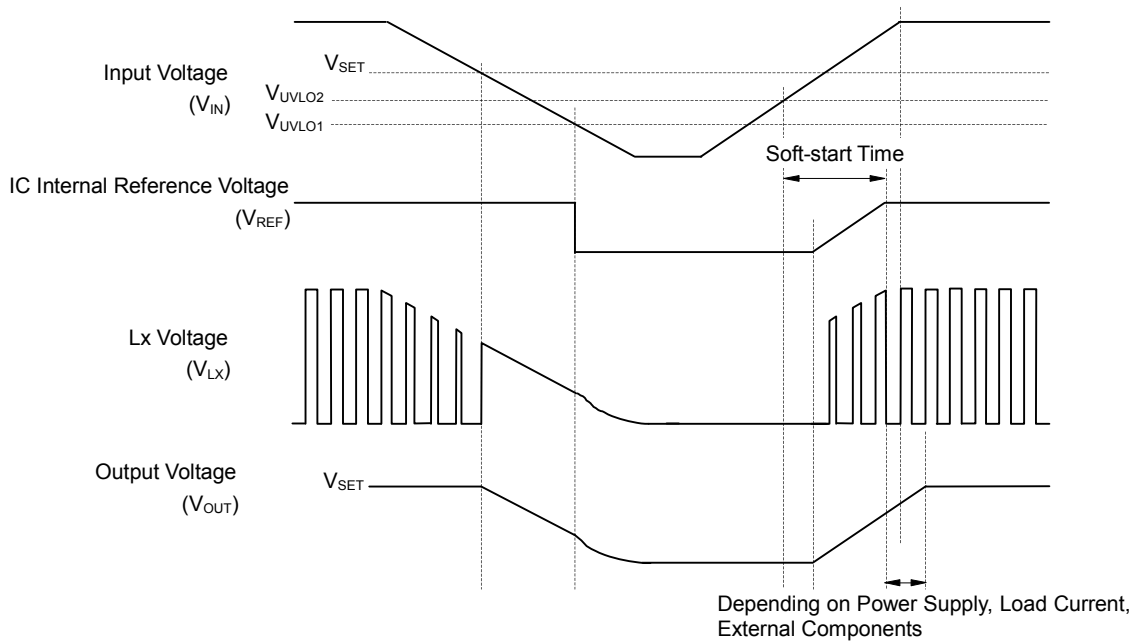

Falling edge (operating) and rising edge (releasing) waveforms of  $V_{OUT}$  could be affected by the initial voltage of  $C_{OUT}$  and the output current of  $V_{OUT}$ .



**Overcurrent Protection Circuit, Latch Type Protection Circuit**

Overcurrent protection circuit supervises the inductor peak current (the peak current flowing through Pch Tr.) in each switching cycle, and if the current exceeds the Lx current limit ( $I_{LXLIM}$ ), it turns off Pch Tr.  $I_{LXLIM}$  of the RP504x is set to Typ.900 mA.

Latch type protection circuit latches the built-in driver to the OFF state and stops the operation of the step-down DC/DC converter if the overcurrent status continues or  $V_{OUT}$  continues being the half of the setting voltage for equal or longer than protection delay time ( $t_{prot}$ ).

Please note that  $I_{LXLIM}$  and  $t_{prot}$  could be easily affected by self-heating or ambient environment. If the  $V_{IN}$  drops dramatically or becomes unstable due to short-circuit, protection operation and  $t_{prot}$  could be affected.



To release the latch type protection circuit, restart the IC by inputting "L" signal to the CE pin, or restart the IC with power-on or make the supply voltage lower than  $V_{UVLO1}$ .

The timing chart below shows the voltage shift of  $V_{CE}$ ,  $V_{LX}$  and  $V_{OUT}$  when the IC status is changed by the following orders:  $V_{IN}$  rising → stable operation → high load → CE reset → stable operation →  $V_{IN}$  falling →  $V_{IN}$  recovering (UVLO reset) → stable operation.

- (1)(2) If the large current flows through the circuit or if the IC goes into low  $V_{OUT}$  condition due to short-circuit or other reasons, the latch type protection circuit latches the built-in driver to "OFF" state after  $t_{prot}$ . Then,  $V_{LX}$  becomes "L" and  $V_{OUT}$  turns "OFF".
- (3) The latch type protection circuit is released by CE reset, which puts the IC into "L" once with the CE pin and back into "H".
- (4) The latch type protection circuit is released by UVLO reset, which makes  $V_{IN}$  lower than  $V_{UVLO1}$ .



## PACKAGE INFORMATION

### POWER DISSIPATION (DFN(PLP)1216-6F)

Power Dissipation ( $P_D$ ) of the package is dependent on PCB material, layout, and environmental conditions. The following conditions are used in this measurement.

#### Measurement Conditions

	Standard Land Pattern
Environment	Mounting on Board (Wind Velocity = 0 m/s)
Board Material	Glass Cloth Epoxy Plastic (Double-sided)
Board Dimensions	40 mm x 40 mm x 1.6 mm
Copper Ratio	Topside: Approx. 50%, Backside: Approx. 50%
Through-holes	$\phi$ 0.3 mm x 26 pcs

#### Measurement Result

( $T_a = 25^\circ\text{C}$ ,  $T_{j\text{max}} = 125^\circ\text{C}$ )

	Standard Land Pattern
Power Dissipation	385 mW
Thermal Resistance	$\theta_{ja} = (125 - 25^\circ\text{C}) / 0.385\text{W} = 260^\circ\text{C/W}$
	$\theta_{jc} = 30^\circ\text{C/W}$



Power Dissipation vs. Ambient Temperature



Measurement Board Pattern

**PACKAGE DIMENSIONS (DFN(PLP)1216-6F)**



**Bottom View**

(Unit : mm)

**DFN(PLP)1216-6F Package Dimensions**

**MARK SPECIFICATION (DFN(PLP)1216-6F)**

①②③④: Product Code ... **Refer to MARK SPECIFICATION TABLE (DFN(PLP)1216-6F).**

⑤⑥: Lot Number ... Alphanumeric Serial Number



**DFN(PLP)1216-6F Mark Specification**

**MARK SPECIFICATION TABLE (DFN(PLP)1216-6F)**

**RP504K**

<b>Product Name</b>	<b>①②③④</b>	<b>Product Name</b>	<b>①②③④</b>
RP504K081A	<b>DA08</b>	RP504K081D	<b>DB08</b>
RP504K091A	<b>DA09</b>	RP504K091D	<b>DB09</b>
RP504K101A	<b>DA10</b>	RP504K101D	<b>DB10</b>
RP504K111A	<b>DA11</b>	RP504K111D	<b>DB11</b>
RP504K121A	<b>DA12</b>	RP504K121D	<b>DB12</b>
RP504K131A	<b>DA13</b>	RP504K131D	<b>DB13</b>
RP504K141A	<b>DA14</b>	RP504K141D	<b>DB14</b>
RP504K151A	<b>DA15</b>	RP504K151D	<b>DB15</b>
RP504K161A	<b>DA16</b>	RP504K161D	<b>DB16</b>
RP504K171A	<b>DA17</b>	RP504K171D	<b>DB17</b>
RP504K181A	<b>DA18</b>	RP504K181D	<b>DB18</b>
RP504K191A	<b>DA19</b>	RP504K191D	<b>DB19</b>
RP504K201A	<b>DA20</b>	RP504K201D	<b>DB20</b>
RP504K211A	<b>DA21</b>	RP504K211D	<b>DB21</b>
RP504K221A	<b>DA22</b>	RP504K221D	<b>DB22</b>
RP504K231A	<b>DA23</b>	RP504K231D	<b>DB23</b>
RP504K241A	<b>DA24</b>	RP504K241D	<b>DB24</b>
RP504K251A	<b>DA25</b>	RP504K251D	<b>DB25</b>
RP504K261A	<b>DA26</b>	RP504K261D	<b>DB26</b>
RP504K271A	<b>DA27</b>	RP504K271D	<b>DB27</b>
RP504K281A	<b>DA28</b>	RP504K281D	<b>DB28</b>
RP504K291A	<b>DA29</b>	RP504K291D	<b>DB29</b>
RP504K301A	<b>DA30</b>	RP504K301D	<b>DB30</b>
RP504K311A	<b>DA31</b>	RP504K311D	<b>DB31</b>
RP504K321A	<b>DA32</b>	RP504K321D	<b>DB32</b>
RP504K331A	<b>DA33</b>	RP504K331D	<b>DB33</b>
RP504K121A5	<b>DA01</b>	RP504K121D5	<b>DB01</b>
RP504K131A5	<b>DA02</b>	RP504K131D5	<b>DB02</b>
RP504K121A2	<b>DA03</b>	RP504K121D2	<b>DB03</b>
RP504K101A5	<b>DA04</b>	RP504K101D5	<b>DB04</b>

**POWER DISSIPATION (DFN1616-6B)**

Power Dissipation ( $P_D$ ) of the package is dependent on PCB material, layout, and environmental conditions. The following conditions are used in this measurement.

Measurement Conditions

	Standard Land Pattern
Environment	Mounting on Board (Wind Velocity = 0 m/s)
Board Material	Glass Cloth Epoxy Plastic (Double-sided)
Board Dimensions	40 mm x 40 mm x 1.6 mm
Copper Ratio	Topside: Approx. 50%, Backside: Approx. 50%
Through-holes	$\phi$ 0.5 mm x 32 pcs

Measurement Result

( $T_a = 25^\circ\text{C}$ ,  $T_{j\text{max}} = 125^\circ\text{C}$ )

	Standard Land Pattern
Power Dissipation	640 mW
Thermal Resistance	$\theta_{ja} = (125 - 25^\circ\text{C}) / 0.64 \text{ W} = 156^\circ\text{C/W}$
	$\theta_{jc} = 23^\circ\text{C/W}$



Power Dissipation vs. Ambient Temperature



Measurement Board Pattern

**PACKAGE DIMENSIONS (DFN1616-6B)**



\*1 The tab on the bottom of the package enhances thermal performance and is electrically connected to GND (substrate level). It is recommended that the tab be connected to the ground plane on the board. If not, the tab can be left open.

**DFN1616-6B Package Dimensions**

**MARK SPECIFICATION (DFN1616-6B)**

①②③④: Product Code ... Refer to MARK SPECIFICATION TABLE (DFN1616-6B).

⑤⑥: Lot Number ... Alphanumeric Serial Number



**DFN1616-6B Mark Specification**

**MARK SPECIFICATION TABLE (DFN1616-6B)**

**RP504L**

<b>Product Name</b>	<b>①②③④</b>
RP504L081A	<b>A Z 0 8</b>
RP504L091A	<b>A Z 0 9</b>
RP504L101A	<b>A Z 1 0</b>
RP504L111A	<b>A Z 1 1</b>
RP504L121A	<b>A Z 1 2</b>
RP504L131A	<b>A Z 1 3</b>
RP504L141A	<b>A Z 1 4</b>
RP504L151A	<b>A Z 1 5</b>
RP504L161A	<b>A Z 1 6</b>
RP504L171A	<b>A Z 1 7</b>
RP504L181A	<b>A Z 1 8</b>
RP504L191A	<b>A Z 1 9</b>
RP504L201A	<b>A Z 2 0</b>
RP504L211A	<b>A Z 2 1</b>
RP504L221A	<b>A Z 2 2</b>
RP504L231A	<b>A Z 2 3</b>
RP504L241A	<b>A Z 2 4</b>
RP504L251A	<b>A Z 2 5</b>
RP504L261A	<b>A Z 2 6</b>
RP504L271A	<b>A Z 2 7</b>
RP504L281A	<b>A Z 2 8</b>
RP504L291A	<b>A Z 2 9</b>
RP504L301A	<b>A Z 3 0</b>
RP504L311A	<b>A Z 3 1</b>
RP504L321A	<b>A Z 3 2</b>
RP504L331A	<b>A Z 3 3</b>
RP504L121A5	<b>A Z 0 1</b>
RP504L131A5	<b>A Z 0 2</b>
RP504L121A2	<b>A Z 0 3</b>
RP504L101A5	<b>A Z 0 4</b>

<b>Product Name</b>	<b>①②③④</b>
RP504L081D	<b>C Z 0 8</b>
RP504L091D	<b>C Z 0 9</b>
RP504L101D	<b>C Z 1 0</b>
RP504L111D	<b>C Z 1 1</b>
RP504L121D	<b>C Z 1 2</b>
RP504L131D	<b>C Z 1 3</b>
RP504L141D	<b>C Z 1 4</b>
RP504L151D	<b>C Z 1 5</b>
RP504L161D	<b>C Z 1 6</b>
RP504L171D	<b>C Z 1 7</b>
RP504L181D	<b>C Z 1 8</b>
RP504L191D	<b>C Z 1 9</b>
RP504L201D	<b>C Z 2 0</b>
RP504L211D	<b>C Z 2 1</b>
RP504L221D	<b>C Z 2 2</b>
RP504L231D	<b>C Z 2 3</b>
RP504L241D	<b>C Z 2 4</b>
RP504L251D	<b>C Z 2 5</b>
RP504L261D	<b>C Z 2 6</b>
RP504L271D	<b>C Z 2 7</b>
RP504L281D	<b>C Z 2 8</b>
RP504L291D	<b>C Z 2 9</b>
RP504L301D	<b>C Z 3 0</b>
RP504L311D	<b>C Z 3 1</b>
RP504L321D	<b>C Z 3 2</b>
RP504L331D	<b>C Z 3 3</b>
RP504L121D5	<b>C Z 0 1</b>
RP504L131D5	<b>C Z 0 2</b>
RP504L121D2	<b>C Z 0 3</b>
RP504L101D5	<b>C Z 0 4</b>

**POWER DISSIPATION (SOT-23-5)**

Power Dissipation ( $P_D$ ) of the package is dependent on PCB material, layout, and environmental conditions. The following conditions are used in this measurement. This data is taken from SOT-23-6.

Measurement Conditions

	Standard Land Pattern
Environment	Mounting on Board (Wind Velocity = 0 m/s)
Board Material	Glass Cloth Epoxy Plastic (Double-sided)
Board Dimensions	40 mm x 40 mm x 1.6 mm
Copper Ratio	Top side: Approx. 50%, Back side: Approx. 50%
Through-holes	$\phi$ 0.5 mm x 44 pcs

Measurement Result

( $T_a = 25^\circ\text{C}$ ,  $T_{j\text{max}} = 125^\circ\text{C}$ )

	Standard Land Pattern	Free Air
Power Dissipation	420 mW	250 mW
Thermal Resistance	$\theta_{ja} = (125 - 25^\circ\text{C}) / 0.42 \text{ W} = 238^\circ\text{C/W}$	400 $^\circ\text{C/W}$

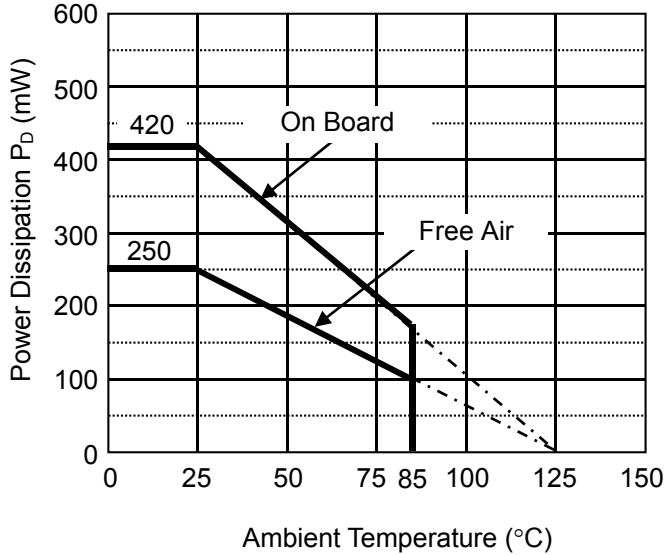

Power Dissipation vs. Ambient Temperature



Measurement Board Pattern



**PACKAGE DIMENSIONS (SOT-23-5)**



**SOT-23-5 Package Dimensions**

**MARK SPECIFICATION (SOT-23-5)**

①②③: Product Code ... **Refer to MARK SPECIFICATION TABLE (SOT-23-5).**

④⑤: Lot Number ... Alphanumeric Serial Number

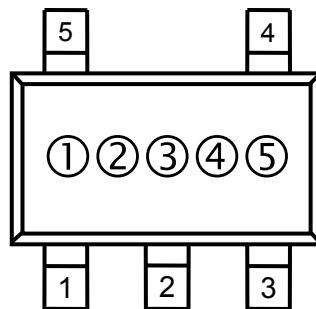

**SOT-23-5 Mark Specification**

**MARK SPECIFICATION TABLE (SOT-23-5)**

**RP504N**

<b>Product Name</b>	<b>①②③</b>	<b>Product Name</b>	<b>①②③</b>
RP504N081B	<b>M 0 8</b>	RP504N081C	<b>N 0 8</b>
RP504N091B	<b>M 0 9</b>	RP504N091C	<b>N 0 9</b>
RP504N101B	<b>M 1 0</b>	RP504N101C	<b>N 1 0</b>
RP504N111B	<b>M 1 1</b>	RP504N111C	<b>N 1 1</b>
RP504N121B	<b>M 1 2</b>	RP504N121C	<b>N 1 2</b>
RP504N131B	<b>M 1 3</b>	RP504N131C	<b>N 1 3</b>
RP504N141B	<b>M 1 4</b>	RP504N141C	<b>N 1 4</b>
RP504N151B	<b>M 1 5</b>	RP504N151C	<b>N 1 5</b>
RP504N161B	<b>M 1 6</b>	RP504N161C	<b>N 1 6</b>
RP504N171B	<b>M 1 7</b>	RP504N171C	<b>N 1 7</b>
RP504N181B	<b>M 1 8</b>	RP504N181C	<b>N 1 8</b>
RP504N191B	<b>M 1 9</b>	RP504N191C	<b>N 1 9</b>
RP504N201B	<b>M 2 0</b>	RP504N201C	<b>N 2 0</b>
RP504N211B	<b>M 2 1</b>	RP504N211C	<b>N 2 1</b>
RP504N221B	<b>M 2 2</b>	RP504N221C	<b>N 2 2</b>
RP504N231B	<b>M 2 3</b>	RP504N231C	<b>N 2 3</b>
RP504N241B	<b>M 2 4</b>	RP504N241C	<b>N 2 4</b>
RP504N251B	<b>M 2 5</b>	RP504N251C	<b>N 2 5</b>
RP504N261B	<b>M 2 6</b>	RP504N261C	<b>N 2 6</b>
RP504N271B	<b>M 2 7</b>	RP504N271C	<b>N 2 7</b>
RP504N281B	<b>M 2 8</b>	RP504N281C	<b>N 2 8</b>
RP504N291B	<b>M 2 9</b>	RP504N291C	<b>N 2 9</b>
RP504N301B	<b>M 3 0</b>	RP504N301C	<b>N 3 0</b>
RP504N311B	<b>M 3 1</b>	RP504N311C	<b>N 3 1</b>
RP504N321B	<b>M 3 2</b>	RP504N321C	<b>N 3 2</b>
RP504N331B	<b>M 3 3</b>	RP504N331C	<b>N 3 3</b>
RP504N121B5	<b>M 0 1</b>	RP504N121C5	<b>N 0 1</b>
RP504N131B5	<b>M 0 2</b>	RP504N131C5	<b>N 0 2</b>

# TYPICAL CHARACTERISTICS

Note: Typical Characteristics are intended to be used as reference data; they are not guaranteed.

## 1) Output Voltage vs. Output Current

RP504x  $V_{OUT} = 0.8\text{ V}$

MODE = "L" PWM/VFM Auto Switching Control

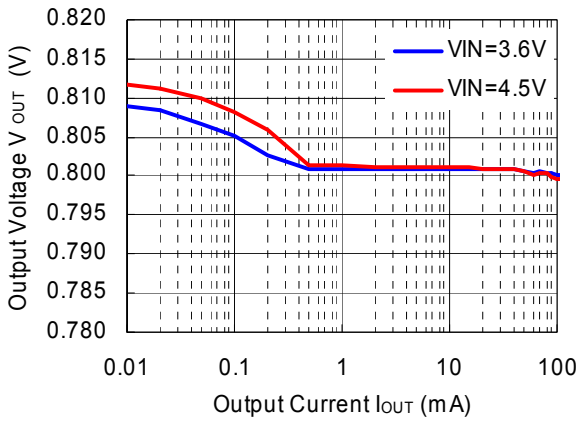

RP504x  $V_{OUT} = 0.8\text{ V}$

MODE = "H" Forced PWM Control

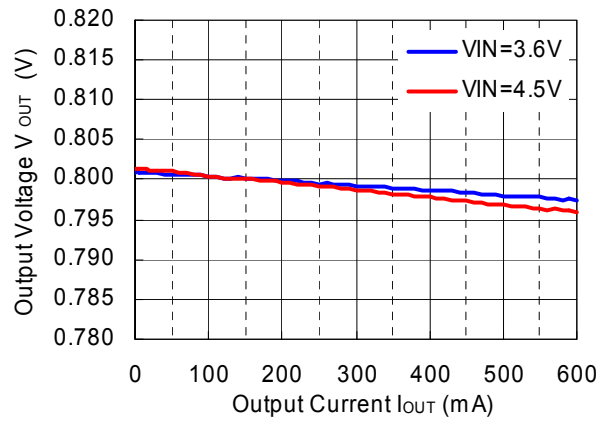

RP504x  $V_{OUT} = 1.2\text{ V}$

MODE = "L" PWM/VFM Auto Switching Control

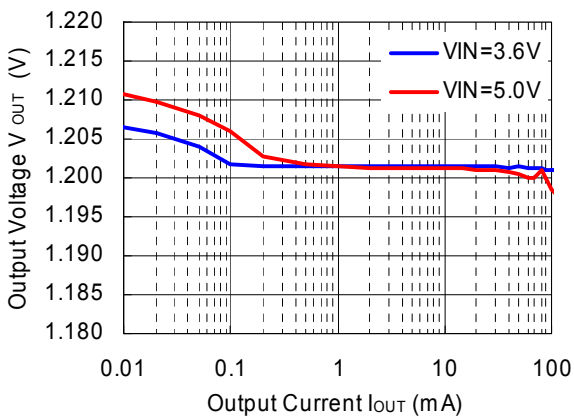

RP504x  $V_{OUT} = 1.2\text{ V}$

MODE = "H" Forced PWM Control

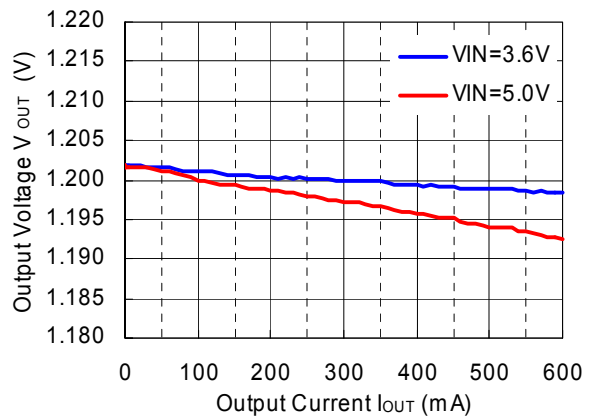

RP504x  $V_{OUT} = 1.8\text{ V}$

MODE = "L" PWM/VFM Auto Switching Control

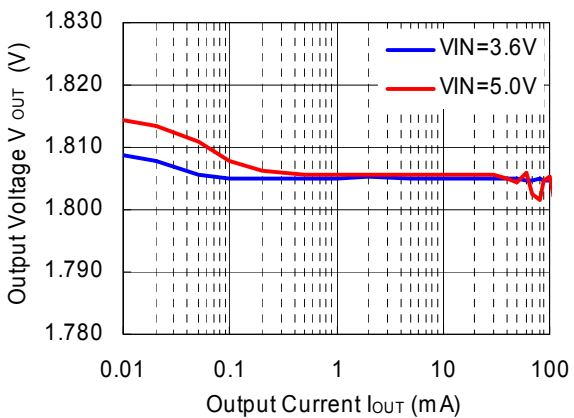

RP504x  $V_{OUT} = 1.8\text{ V}$

MODE = "H" Forced PWM Control

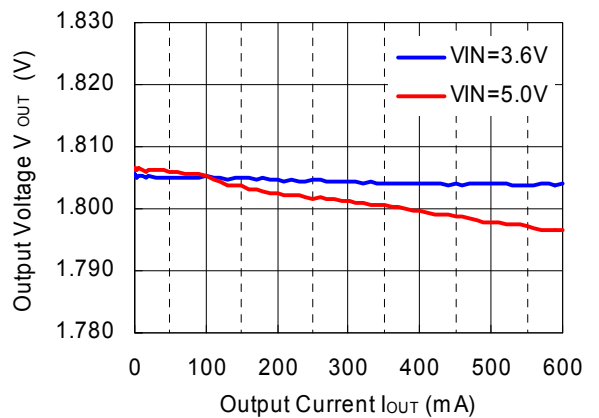

**RP504x  $V_{OUT} = 3.3\text{ V}$**   
**MODE = "L" PWM/VFM Auto Switching Control**

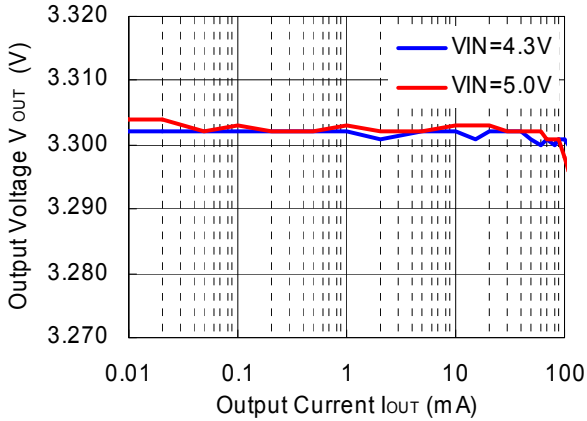

**RP504x  $V_{OUT} = 3.3\text{ V}$**   
**MODE = "H" Forced PWM Control**

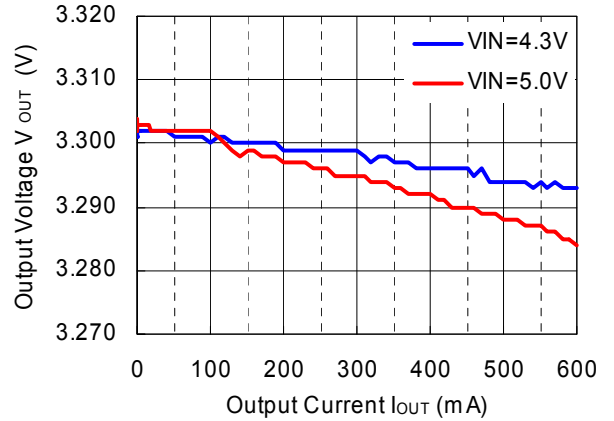

**2) Output Voltage vs. Input Voltage**

**RP504x  $V_{OUT} = 0.8\text{ V}$**   
**MODE = "H" Forced PWM Control**



**RP504x  $V_{OUT} = 1.2\text{ V}$**   
**MODE = "H" Forced PWM Control**



**RP504x  $V_{OUT} = 1.8\text{ V}$**   
**MODE = "H" Forced PWM Control**



**RP504x  $V_{OUT} = 3.3\text{ V}$**   
**MODE = "H" Forced PWM Control**



### 3) Output Voltage vs. Temperature



### 4) Efficiency vs. Output Current

RP504x  $V_{OUT} = 0.8V$



RP504x  $V_{OUT} = 1.2V$



RP504x  $V_{OUT} = 1.8V$



RP504x  $V_{OUT} = 3.3V$



5) Supply Current vs. Temperature

RP504x  $V_{OUT} = 1.8\text{ V}$  ( $V_{IN} = 5.5\text{ V}$ )

MODE = "L" PWM/VFM Auto Switching Control



6) Supply Current vs. Input Voltage

RP504x  $V_{OUT} = 1.8\text{ V}$

MODE = "L" PWM/VFM Auto Switching Control



7) Output Voltage Waveform

RP504x  $V_{OUT} = 0.8\text{ V}$  ( $V_{IN} = 3.6\text{ V}$ )

MODE = "L" PWM/VFM Auto Switching Control

$I_{OUT}=10\text{mA}$

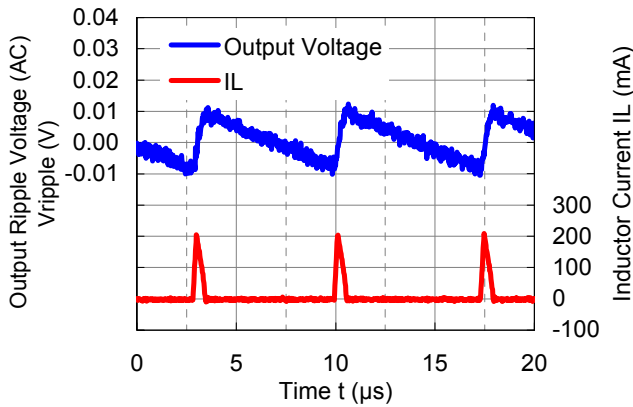

RP504x  $V_{OUT} = 0.8\text{ V}$  ( $V_{IN} = 3.6\text{ V}$ )

MODE = "H" Forced PWM Control

$I_{OUT}=10\text{mA}$

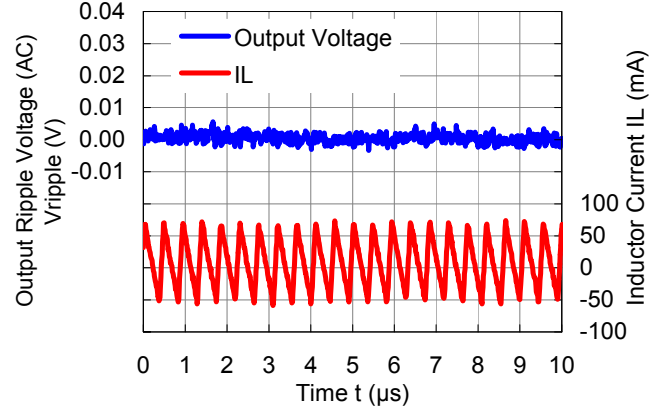

RP504x  $V_{OUT} = 1.2\text{ V}$  ( $V_{IN} = 3.6\text{ V}$ )

MODE = "L" PWM/VFM Auto Switching Control

$I_{OUT}=10\text{mA}$



RP504x  $V_{OUT} = 1.2\text{ V}$  ( $V_{IN} = 3.6\text{ V}$ )

MODE = "H" Forced PWM Control

$I_{OUT}=10\text{mA}$

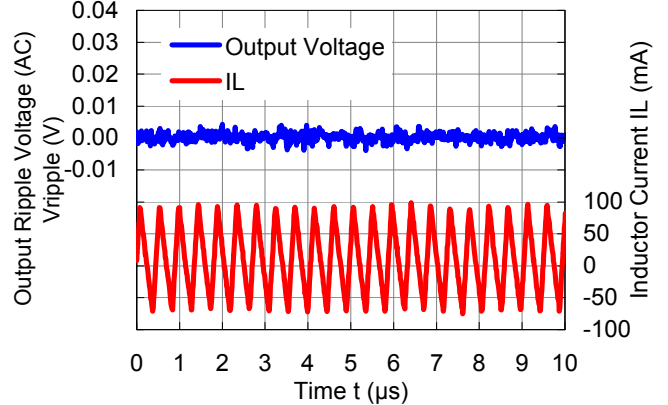

**RP504x**  $V_{OUT} = 1.8\text{ V}$  ( $V_{IN} = 3.6\text{ V}$ )  
**MODE = "L" PWM/VFM Auto Switching Control**



**RP504x**  $V_{OUT} = 1.8\text{ V}$  ( $V_{IN} = 3.6\text{ V}$ )  
**MODE = "H" Forced PWM Control**

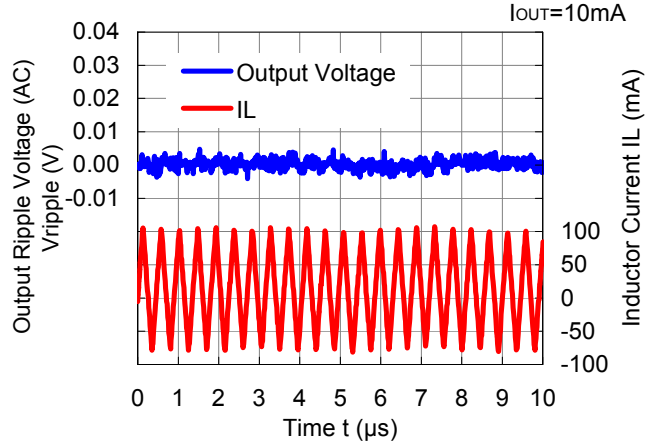

**RP504x**  $V_{OUT} = 3.3\text{ V}$  ( $V_{IN} = 5.0\text{ V}$ )  
**MODE = "L" PWM/VFM Auto Switching Control**



**RP504x**  $V_{OUT} = 3.3\text{ V}$  ( $V_{IN} = 5.0\text{ V}$ )  
**MODE = "H" Forced PWM Control**

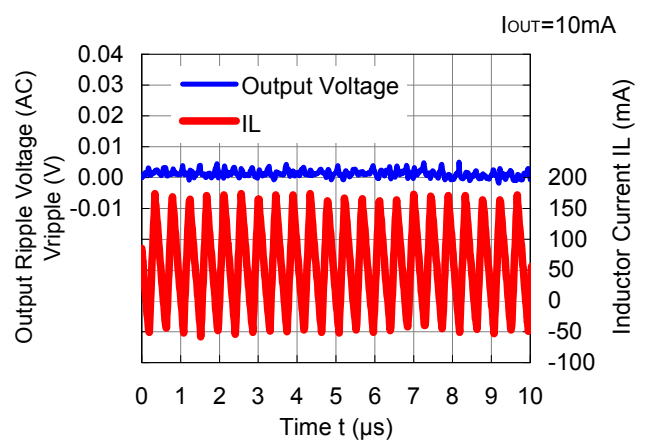

**8) Frequency vs. Temperature**



**9) Frequency vs. Input Voltage**



10) Soft Start Time vs. Temperature



11) UVLO Detector Threshold / Released Voltage vs. Temperature

UVLO Detector Threshold Voltage



UVLO Released Voltage



12) CE Input Voltage vs. Temperature

CE "H" Input Voltage (V<sub>IN</sub> = 5.5 V)



CE "H" Input Voltage (V<sub>IN</sub> = 2.3 V)





13) L<sub>x</sub> Current Limit vs. Temperature



14) Nch Tr. ON Resistance vs. Temperature



15) Pch Tr. ON Resistance vs. Temperature



16) Load Transient Response

RP504x081x (V<sub>IN</sub> = 3.6 V)

MODE = "L" PWM/VFM Auto Switching Control



RP504x081x (V<sub>IN</sub> = 3.6 V)

MODE = "L" PWM/VFM Auto Switching Control



RP504x081x ( $V_{IN} = 3.6\text{ V}$ )  
MODE = "H" Forced PWM Control



RP504x081x ( $V_{IN} = 3.6\text{ V}$ )  
MODE = "H" Forced PWM Control



RP504x081x ( $V_{IN} = 3.6\text{ V}$ )



RP504x081x ( $V_{IN} = 3.6\text{ V}$ )



RP504x121x ( $V_{IN} = 3.6\text{ V}$ )  
MODE = "L" PWM/VFM Auto Switching Control



RP504x121x ( $V_{IN} = 3.6\text{ V}$ )  
MODE = "L" PWM/VFM Auto Switching Control



**RP504x121x ( $V_{IN} = 3.6\text{ V}$ )**  
**MODE = "H" Forced PWM Control**



**RP504x121x ( $V_{IN} = 3.6\text{ V}$ )**  
**MODE = "H" Forced PWM Control**



**RP504x121x ( $V_{IN} = 3.6\text{ V}$ )**



**RP504x121x ( $V_{IN} = 3.6\text{ V}$ )**

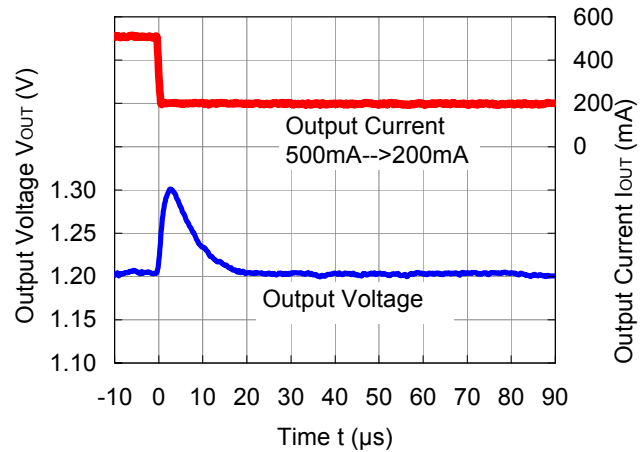

**RP504x181x ( $V_{IN} = 3.6\text{ V}$ )**  
**MODE = "L" PWM/VFM Auto Switching Control**



**RP504x181x ( $V_{IN} = 3.6\text{ V}$ )**  
**MODE = "L" PWM/VFM Auto Switching Control**

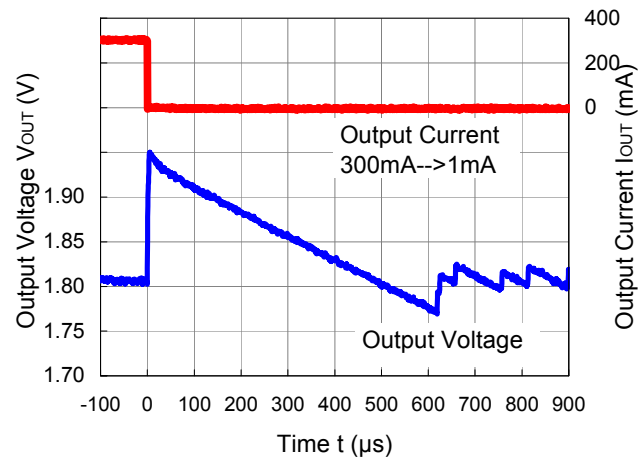

RP504x181x ( $V_{IN} = 3.6\text{ V}$ )  
MODE = "H" Forced PWM Control



RP504x181x ( $V_{IN} = 3.6\text{ V}$ )  
MODE = "H" Forced PWM Control



RP504x181x ( $V_{IN} = 3.6\text{ V}$ )

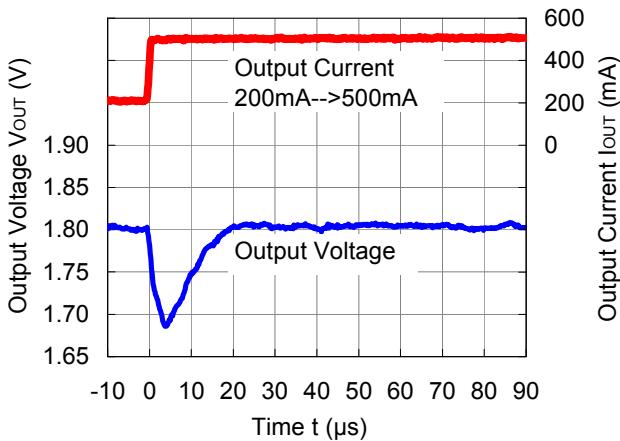

RP504x181x ( $V_{IN} = 3.6\text{ V}$ )

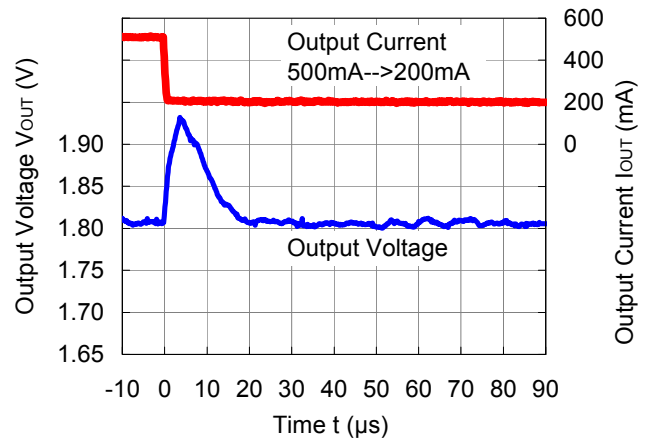

RP504x331x ( $V_{IN} = 5.0\text{ V}$ )  
MODE = "L" PWM/VFM Auto Switching Control



RP504x331x ( $V_{IN} = 5.0\text{ V}$ )  
MODE = "L" PWM/VFM Auto Switching Control





**17) Mode Switching Waveform**



RP504x ( $V_{OUT} = 1.8\text{ V}$ ,  $I_{OUT} = 1\text{ mA}$ )  
MODE = "L" --> MODE = "H"



RP504x ( $V_{OUT} = 1.8\text{ V}$ ,  $I_{OUT} = 1\text{ mA}$ )  
MODE = "H" --> MODE = "L"





1. The products and the product specifications described in this document are subject to change or discontinuation of production without notice for reasons such as improvement. Therefore, before deciding to use the products, please refer to Ricoh sales representatives for the latest information thereon.
2. The materials in this document may not be copied or otherwise reproduced in whole or in part without prior written consent of Ricoh.
3. Please be sure to take any necessary formalities under relevant laws or regulations before exporting or otherwise taking out of your country the products or the technical information described herein.
4. The technical information described in this document shows typical characteristics of and example application circuits for the products. The release of such information is not to be construed as a warranty of or a grant of license under Ricoh's or any third party's intellectual property rights or any other rights.
5. The products listed in this document are intended and designed for use as general electronic components in standard applications (office equipment, telecommunication equipment, measuring instruments, consumer electronic products, amusement equipment etc.). Those customers intending to use a product in an application requiring extreme quality and reliability, for example, in a highly specific application where the failure or misoperation of the product could result in human injury or death (aircraft, spacevehicle, nuclear reactor control system, traffic control system, automotive and transportation equipment, combustion equipment, safety devices, life support system etc.) should first contact us.
6. We are making our continuous effort to improve the quality and reliability of our products, but semiconductor products are likely to fail with certain probability. In order to prevent any injury to persons or damages to property resulting from such failure, customers should be careful enough to incorporate safety measures in their design, such as redundancy feature, fire containment feature and fail-safe feature. We do not assume any liability or responsibility for any loss or damage arising from misuse or inappropriate use of the products.
7. Anti-radiation design is not implemented in the products described in this document.
8. Please contact Ricoh sales representatives should you have any questions or comments concerning the products or the technical information.



**Ricoh is committed to reducing the environmental loading materials in electrical devices with a view to contributing to the protection of human health and the environment.**

Ricoh has been providing RoHS compliant products since April 1, 2006 and Halogen-free products since April 1, 2012.

**RICOH** RICOH ELECTRONIC DEVICES CO., LTD.

<http://www.e-devices.ricoh.co.jp/en/>

#### Sales & Support Offices

##### **RICOH ELECTRONIC DEVICES CO., LTD.**

**Higashi-Shinagawa Office (International Sales)**  
3-32-3, Higashi-Shinagawa, Shinagawa-ku, Tokyo 140-8655, Japan  
Phone: +81-3-5479-2857 Fax: +81-3-5479-0502

##### **RICOH EUROPE (NETHERLANDS) B.V.**

**Semiconductor Support Centre**  
Prof. W.H. Keesomlaan 1, 1183 DJ Amstelveen, The Netherlands  
Phone: +31-20-5474-309

##### **RICOH ELECTRONIC DEVICES KOREA CO., LTD.**

3F, Haesung Bldg. 504, Teheran-ro, Gangnam-gu, Seoul, 135-725, Korea  
Phone: +82-2-2135-5700 Fax: +82-2-2051-5713

##### **RICOH ELECTRONIC DEVICES SHANGHAI CO., LTD.**

Room 403, No.2 Building, No.690 Bilbo Road, Pu Dong New District, Shanghai 201203, People's Republic of China  
Phone: +86-21-5027-3200 Fax: +86-21-5027-3299

##### **RICOH ELECTRONIC DEVICES CO., LTD.**

**Taipei office**  
Room 109, 10F-1, No.51, Hengyang Rd., Taipei City, Taiwan (R.O.C.)  
Phone: +886-2-2313-1621/1622 Fax: +886-2-2313-1623

# Mouser Electronics

Authorized Distributor

Click to View Pricing, Inventory, Delivery & Lifecycle Information:

## Ricoh Electronics:

[RP504L191D-TR](#) [RP504L181D-TR](#) [RP504N301B-TR-FE](#) [RP504N151B-TR-FE](#) [RP504N121B-TR-FE](#) [RP504N331B-TR-FE](#) [RP504N331C-TR-FE](#) [RP504L281D-TR](#) [RP504L241D-TR](#) [RP504K111D-E2](#) [RP504L101A-TR](#) [RP504N101B-TR-FE](#) [RP504N251B-TR-FE](#) [RP504K301D-E2](#) [RP504K311D-E2](#) [RP504L121D-TR](#) [RP504L131D5-TR](#) [RP504K101A-E2](#) [RP504L151D-TR](#) [RP504K121D-E2](#) [RP504N121C-TR-FE](#) [RP504N181C-TR-FE](#) [RP504K231D-E2](#) [RP504N181B-TR-FE](#) [RP504L331D-TR](#) [RP504K121D5-E2](#)





Компания «ЭлектроПласт» предлагает заключение долгосрочных отношений при поставках импортных электронных компонентов на взаимовыгодных условиях!

Наши преимущества:

- Оперативные поставки широкого спектра электронных компонентов отечественного и импортного производства напрямую от производителей и с крупнейших мировых складов;
- Поставка более 17-ти миллионов наименований электронных компонентов;
- Поставка сложных, дефицитных, либо снятых с производства позиций;
- Оперативные сроки поставки под заказ (от 5 рабочих дней);
- Экспресс доставка в любую точку России;
- Техническая поддержка проекта, помощь в подборе аналогов, поставка прототипов;
- Система менеджмента качества сертифицирована по Международному стандарту ISO 9001;
- Лицензия ФСБ на осуществление работ с использованием сведений, составляющих государственную тайну;
- Поставка специализированных компонентов (Xilinx, Altera, Analog Devices, Intersil, Interpoint, Microsemi, Aeroflex, Peregrine, Syfer, Eurofarad, Texas Instrument, Miteq, Cobham, E2V, MA-COM, Hittite, Mini-Circuits, General Dynamics и др.);

Помимо этого, одним из направлений компании «ЭлектроПласт» является направление «Источники питания». Мы предлагаем Вам помощь Конструкторского отдела:

- Подбор оптимального решения, техническое обоснование при выборе компонента;
- Подбор аналогов;
- Консультации по применению компонента;
- Поставка образцов и прототипов;
- Техническая поддержка проекта;
- Защита от снятия компонента с производства.



#### Как с нами связаться

**Телефон:** 8 (812) 309 58 32 (многоканальный)

**Факс:** 8 (812) 320-02-42

**Электронная почта:** [org@eplast1.ru](mailto:org@eplast1.ru)

**Адрес:** 198099, г. Санкт-Петербург, ул. Калинина, дом 2, корпус 4, литера А.