

# PCA3

PCIe x4 Cable Adapter, for PCIe Gen3

## USER MANUAL

# CONTENTS

<b>Chapter 1</b>	<b>Introduction .....</b>	<b>2</b>
1.1	Package Contents.....	2
1.2	Features.....	3
1.3	Getting Help .....	4
<b>Chapter 2</b>	<b>Architecture .....</b>	<b>5</b>
2.1	Layout and Components.....	5
2.2	Block Diagram of the PCA3 card.....	6
<b>Chapter 3</b>	<b>Card Components .....</b>	<b>8</b>
3.1	PCIe Edge Connector .....	8
3.2	PCIe Cable Connector .....	10
3.3	LEDs.....	14
3.4	Lane Re-driver IC.....	14
<b>Chapter 4</b>	<b>Setup Example.....</b>	<b>16</b>
4.1	Introduction .....	16
4.2	PC PCI Express Software SDK.....	16
4.3	Reference Design - Fundamental .....	28
4.4	PCIe Reference Design – DDR3 .....	34
<b>Chapter 5</b>	<b>Appendix .....</b>	<b>41</b>
5.1	Revision History.....	41
5.2	Copyright Statement .....	41

# Chapter 1

## *Introduction*

PCA3 (PCIe Cable Adapter, Gen 3) is a conversion card to connect boards with your host PC. It can support up to PCIe Gen 3 x4. Users with boards such as Terasic TR4 and TR5 can establish high-speed data transmission through this card and the PCIe cable via PCIe connector to any host PC. It provides automatic rate-detect and adaptation to PCIe Gen-1, Gen-2, and Gen-3 speeds.

### 1.1 Package Contents

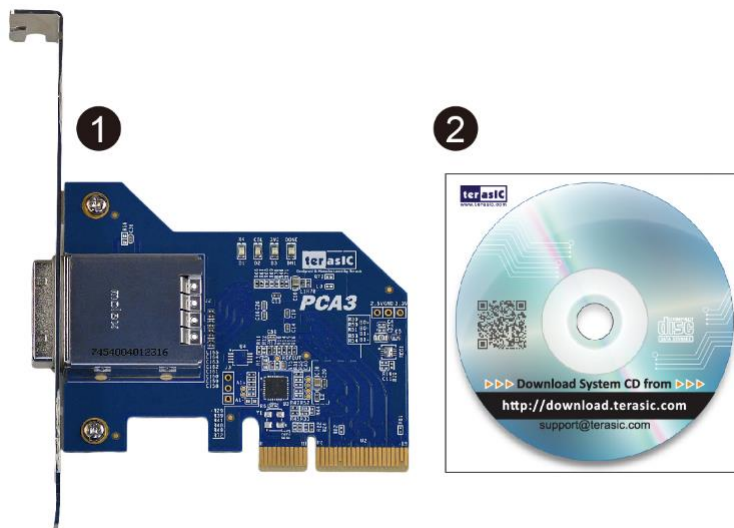

Figure 1-1 The PCA3 package contents

The PCA3 package includes:

- 1 PCA3 card
- 2 System CD Download Guide



## 1.2 Features

Figure 1- shows a photograph of the PCA3.



Figure 1-2 Exterior View

The key features of the card are listed below:

- Up to 8.0Gbps PCIe 3.0 Serial Re-Driver
- PCIe x4 Gen 3
- Adjustable receiver equalization
- Adjustable transmitter amplitude and de-emphasis

## 1.3 Getting Help

Here is information of how to get help if you encounter any problem:

Terasic Technologies

- Tel: +886-3-550-8800
- Email: [support@terasic.com](mailto:support@terasic.com)

# Chapter 2

## Architecture

This chapter provides information about architecture and block diagram of the PCA3 card.

### 2.1 Layout and Components

The picture of the Terasic PCIe x4 Cable Adapter (PCA3) is shown in **Figure 2-1** and **Figure 2-2**. It depicts the layout of the card and indicates the locations of the connectors and key components.

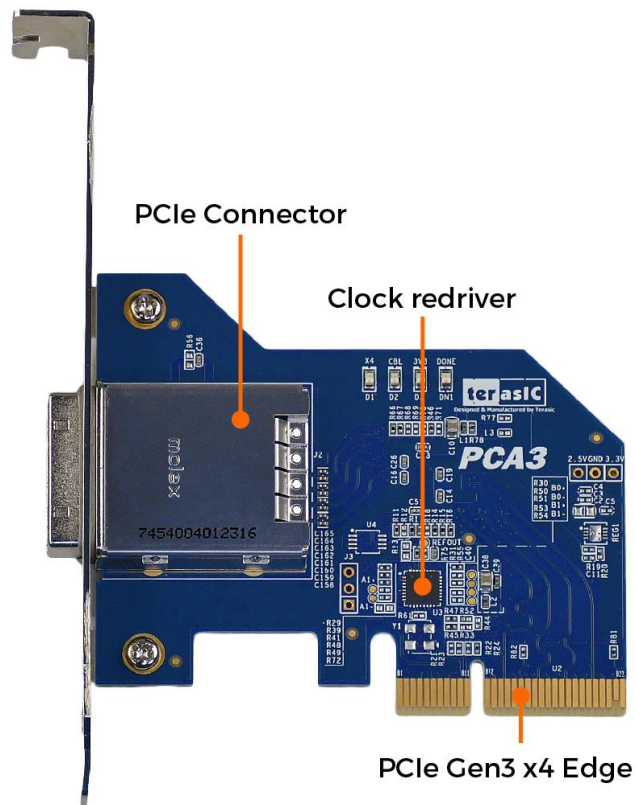

Figure 2-1 The PCA3 Card PCB and Component Diagram (top view)

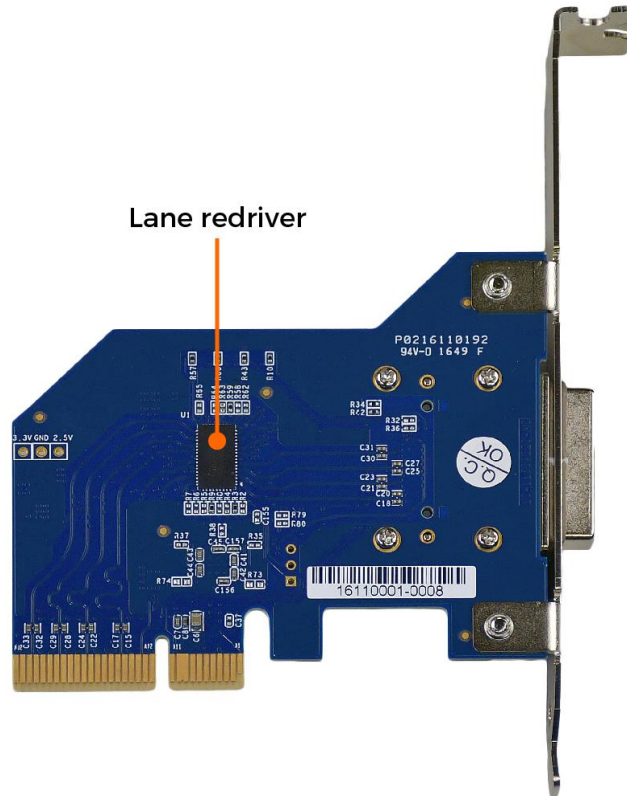

Figure 2-2 The PCA3 Card PCB and Component Diagram (bottom view)

## 2.2 Block Diagram of the PCA3 card

Figure 2-3 shows the block diagram of the PCA3 card.

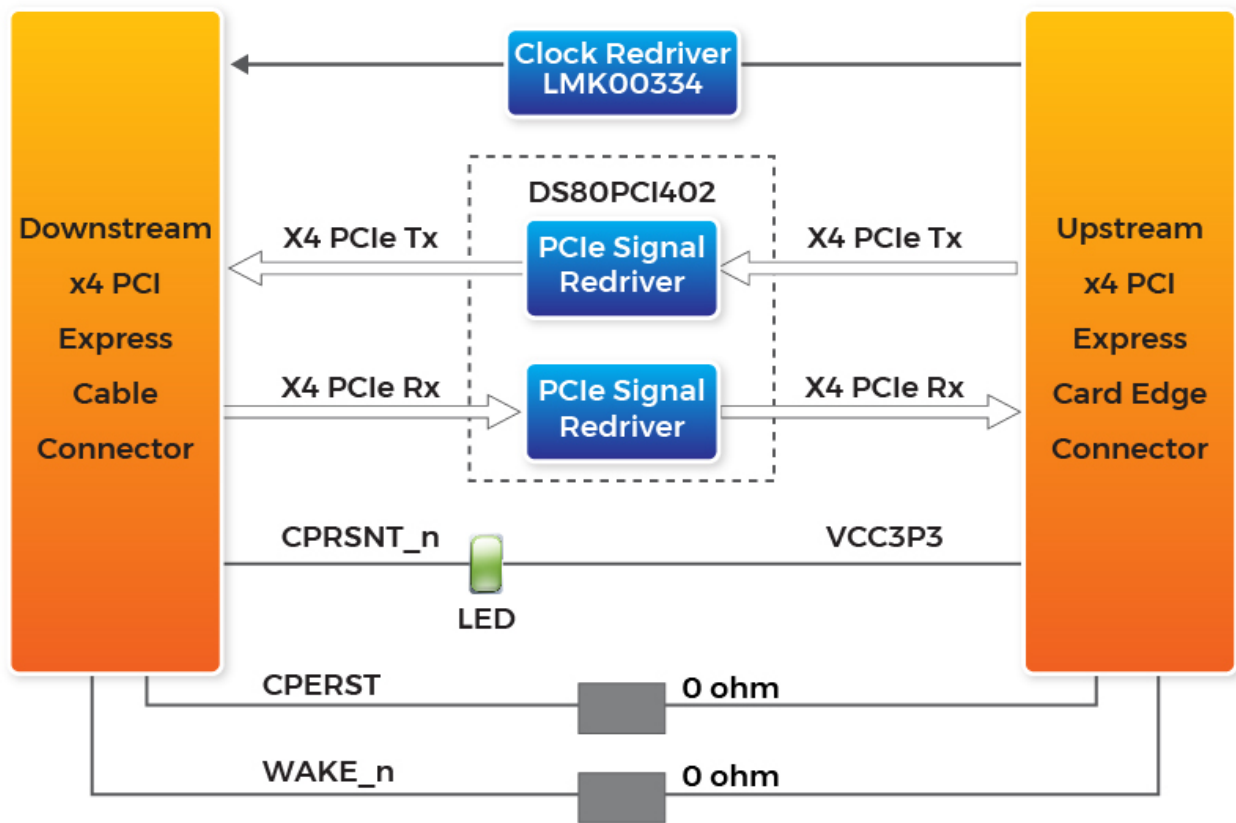

Figure 2-3 Block Diagram of PCA3



## Chapter 3

# *Card Components*

This chapter describes the specifications of the onboard components.

### **3.1 PCIe Edge Connector**

This PCIe edge connector is used to connect the PCA3 with PC motherboard PCIe slot, as show **Figure 3-1** and **Figure 3-2**.

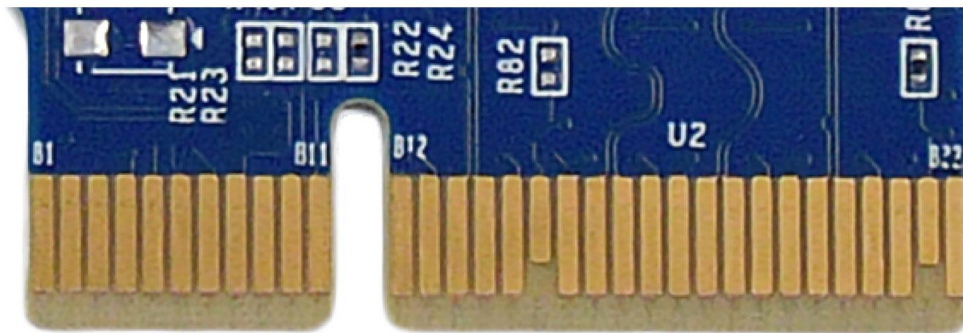

Figure 3-1 PCA3 Edge Connector

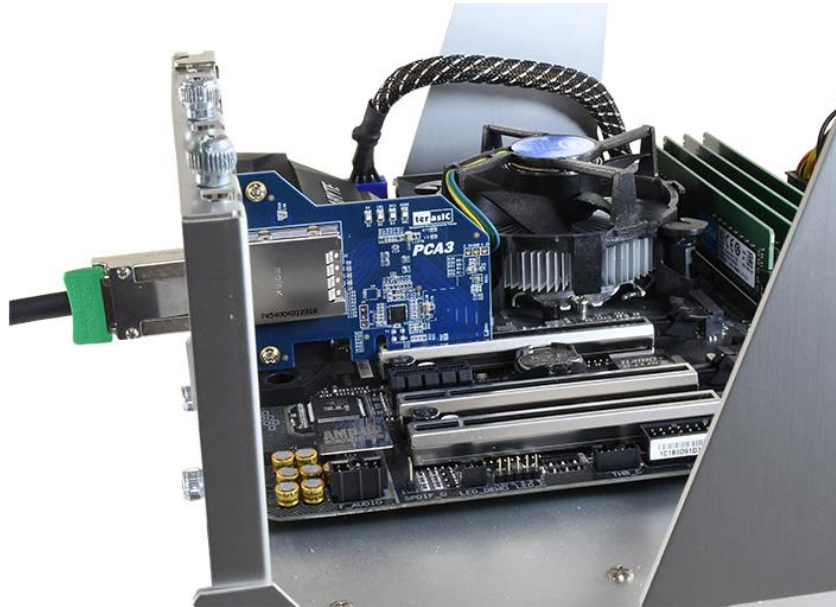

Figure 3-2 Plug the PCA3 into the PCIe slot of the Motherboard

The pins are defined as shown in Table 3-1 with side A on the top of the center-line on the solder side of the card and side B on the bottom of the centerline on the component side of the card.

The PCIe interface pins PETpx, PETnx, PERpx, and PERnx are named with the following convention: “PE” stands for PCIe high speed, “T” for Transmitter, “R” for Receiver, “p” for positive (+), and “n” for negative (-).

Note that adjacent differential pairs are separated by two ground pins to manage the connector crosstalk.

**Table 3-1** gives the wiring information of the PCIe Edge connector.

Table 3-1 Pin assignments and descriptions on PCIe Edge connector

Pin Numbers	Side B		Side A	
	Name	Description	Name	Description
1	NC	NC	PRSNT1n	Hot-Plug presence detect
2	NC	NC	NC	NC
3	NC	NC	NC	NC
4	GND	Ground	GND	Ground
5	SMCLK	System Clock	NC	NC

6	SMDAT	System Data Line	NC	NC
7	GND	Ground	NC	NC
8	VCC3P3	3.3V Power	NC	NC
9	NC	NC	VCC3P3	3.3V Power
10	3.3VAUX	3.3 V Auxiliary Power	VCC3P3	3.3V Power
11	WAKE	NC	PERSTn	Fundamental Reset
Mechanical Key				
12	RSVD	Reserved	GND	Ground
13	GND	Ground	REFCLK+	Reference clock
14	PETp0	Transmitter differential pair,	REFCLK-	(differential pair)
15	PETn0	Lane 0	GND	Ground
16	GND	Ground	PERp0	Receiver
17	PRSNT2n	Hot-Plug presence detect	PERn0	differential pair, Lane 0
18	GND	Ground	GND	Ground
19	PETp1	Transmitter	RSVD	Reserved
20	PETn1	differential pair, Lane 1	GND	Ground
21	GND	Ground	PERp1	Receiver
22	GND	Ground	PERn1	differential pair, Lane 1
23	PETp2	Transmitter	GND	Ground
24	PETn2	differential pair, Lane 2	GND	Ground
25	GND	Ground	PERp2	Receiver
26	GND	Ground	PERn2	differential pair, Lane 2
27	PETp3	Transmitter	GND	Ground
28	PETn3	differential pair, Lane 3	GND	Ground
29	GND	Ground	PERp3	Receiver
30	RSVD	Reserved	PERn3	differential pair, Lane 3
31	PRSNT2n	Hot-Plug presence detect	GND	Ground
32	GND	Ground	RSVD	Reserved

## 3.2 PCIe Cable Connector

A PCIe cable connector is used to connect the PCIe x4 Cable and PCA cable connector, connect the

adapter by using a PCIe x4 Cable, as show **Figure 3-3**.

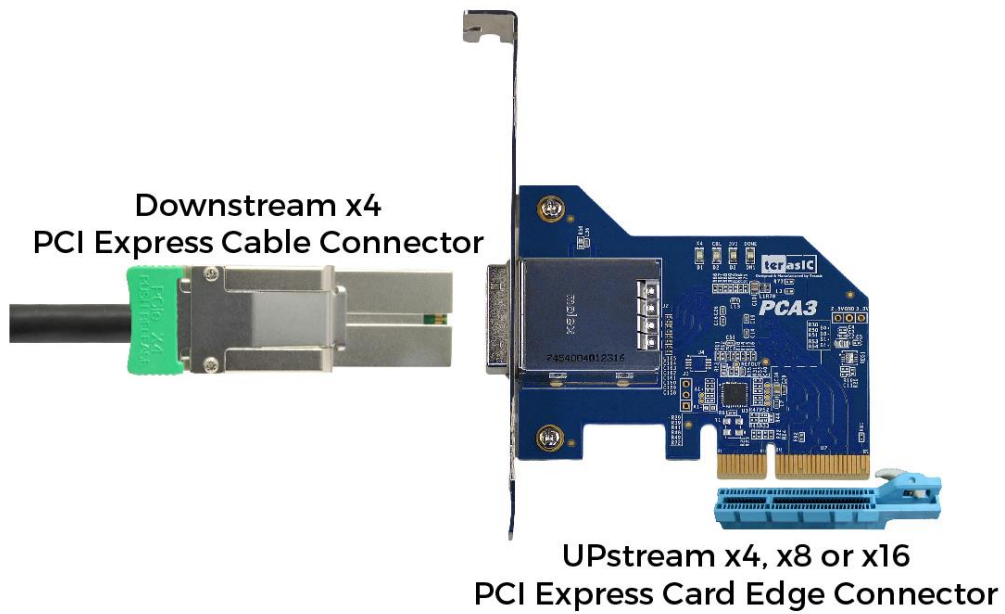

Figure 3-3 PCIe x4 Cable and PCA3

To purchase the PCIe x4 Cable, please refer to the url: [PCIe.Cable.terasic.com](http://PCIe.Cable.terasic.com).

**Figure 3-4** shows the PCIe Cable connects PCA3 connector

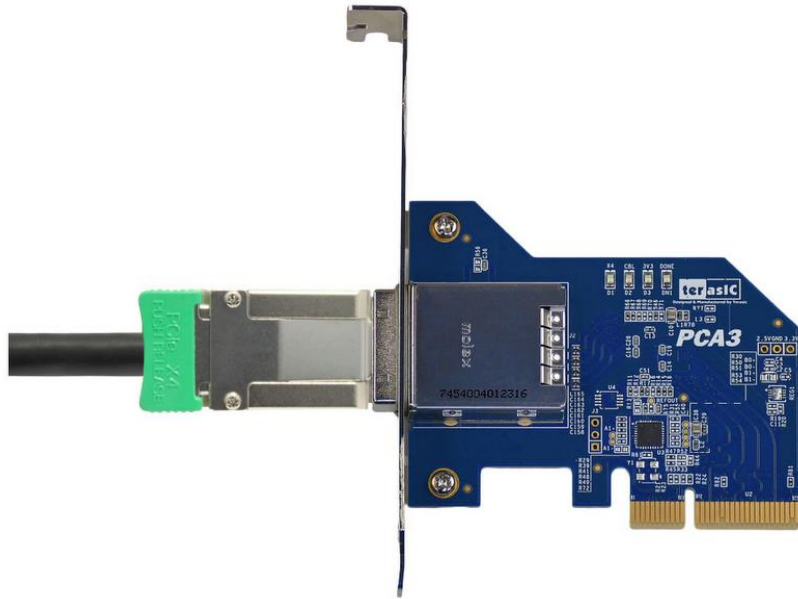

Figure 3-4 PCIe Cable and PCA3 connector Connected

Table 3-2 gives the wiring information of the PCIe Cable connector.

Table 3-2 wiring information of the PCIe Cable connector

Pin Numbers	Name	Description
A1	GND	Ground reference for PCI Express transmitter Lanes
A2	PETp0	Differential PCI Express transmitter Lane 0
A3	PETn0	Differential PCI Express transmitter Lane 0
A4	GND	Ground reference for PCI Express transmitter Lanes
A5	PETp1	Differential PCI Express transmitter Lane 1
A6	PETn1	Differential PCI Express transmitter Lane 1
A7	GND	Ground reference for PCI Express transmitter Lanes
A8	PETp2	Differential PCI Express transmitter Lane 2
A9	PETn2	Differential PCI Express transmitter Lane 2
A10	GND	Ground reference for PCI



		Express transmitter Lanes
A11	PETp3	Differential PCI Express transmitter Lane 3
A12	PETn3	Differential PCI Express transmitter Lane 3
A13	GND	Ground reference for PCI Express transmitter Lanes
A14	CREFLK+	Differential 100MHz cable reference clock
A15	CREFLK-	Differential 100MHz cable reference clock
A16	GND	Ground reference for PCI Express transmitter Lanes
A17	SB_RTN	Signal return for single ended sideband signals
A18	CPRSNTn	Used for detection of whether a cable is installed and the downstream subsystem is powered
A19	CPWRON	Turns power on / off to slave type downstream subsystems
B1	GND	Ground reference for PCI Express transmitter Lanes
B2	PERp0	Differential PCI Express receiver Lane 0
B3	PERn0	Differential PCI Express receiver Lane 0
B4	GND	Ground reference for PCI Express transmitter Lanes
B5	PERp1	Differential PCI Express receiver Lane 1
B6	PERn1	Differential PCI Express receiver Lane 1
B7	GND	Ground reference for PCI Express transmitter Lanes
B8	PERp2	Differential PCI Express receiver Lane 2
B9	PERn2	Differential PCI Express receiver Lane 2
B10	GND	Ground reference for PCI Express transmitter Lanes
B11	PERp3	Differential PCI Express receiver Lane 3
B12	PERn3	Differential PCI Express

		receiver Lane 3
B13	GND	Ground reference for PCI Express transmitter Lanes
B14	PWR	+3.3V Cable power
B15	PWR	+3.3V Cable power
B16	PWR RTN	Cable power return
B17	PWR RTN	Cable power return
B18	CWAKEn	Power management signal for wakeup events (optional)
B19	CPERSTn	Cable PERSTn

### 3.3 LEDs

The PCA3 includes status LEDs, please refer to **Table 3-3** for the status of the LED indicator.

Table 3-3 Status of the LED indicator

Board Reference	LED name	Description
D1	CBL	Cable PRSNT1n
D2	EDGE	Edge PRSNT1n
D3	POWER	Power LED

### 3.4 Lane Re-driver IC

A Lane Re-driver IC U1(DS80PCI402) is implemented on PCA3 card. In addition to supporting the 4-lane repeater function, DS80PCI402 chip also supports some modifiable parameters, such as input equalization, internal Signal Detect Threshold and loopback function. These functions can be set up by some of the resistances on PCA3 card, Figure 3-5 shows the resistances setting. **Table 3-4** lists pin configuration and function.

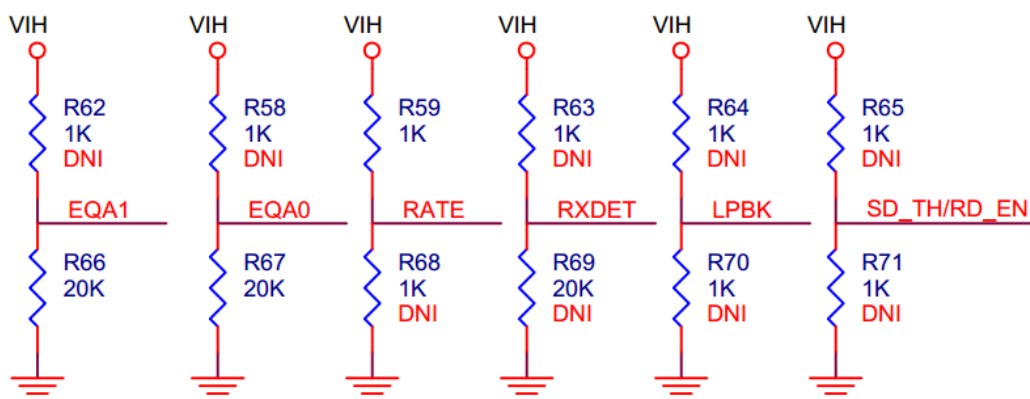

Figure 3-5 Resistances setting

Table 3-4 Pin configuration and function

Pin Numbers	Name	Description
19	EQA1	EQA1 control the level of equalization on the input pins. The pins are active only when ENSMB is deasserted (low).
20	EQA0	EQA0 control the level of equalization on the input pins. The pins are active only when ENSMB is deasserted (low).
21	RATE	RATE control pin selects GEN 1,2 and GEN 3 operating modes. Tie 1kΩ to GND = GEN 1,2 FLOAT = AUTO Rate Select of Gen1/2 and Gen3 with de-emphasis Tie 20kΩ to GND = GEN 3 without de-emphasis Tied 1kΩ to VDD = RESERVED
22	RXDET	The RXDET pin controls the receiver detect function. Depending on the input level, a 50Ω or > 50kΩ termination to the power rail is enabled.
23	LPBK	Controls the loopback function Tie 1kΩ to GND = Root Complex Loopback (INA_n to OUTB_n) Float = Normal Operation Tie 1kΩ to VDD = End-point Loopback (INB_n to OUTA_n)
26	SD_TH/RD_EN	Controls the internal Signal Detect Threshold

## Chapter 4

# Setup Example

This chapter demonstrates how to use PCA3 daughtercard with FPGA host board. In the system CD, we provide demonstration projects for Terasic TR4 and TR5 FPGA board. We will introduce how to use PCA3 daughtercard and Terasic TR5 FPGA development board to communicate with the PC via PCIe interface. For PCA3 with TR4 board, please refer to the CD folder .../Demonstrations/TR4/doc/ for detailed document description.

### 4.1 Introduction

The application reference design shows how to implement fundamental control and data transfer by using **PCIe** port on the TR5. In the design, basic I/O is used to read or write the buttons and LEDs on the TR5. High-speed data transfer is performed by DMA. Both Memory-Mapped and FIFO memory types are demonstrated in the reference design. The demonstration also makes use of the associated PCIe cable adapter card (PCA3). System Requirements

The following items are required for the PCA demonstration

- TR5 board           x1
- PCA3 card           x1
- PCIe x4 Cable       x1
- PC                    x1

### 4.2 PC PCI Express Software SDK

The CD contains a PC Windows based SDK to allow users to develop their 64-bits software application on Windows XP/7/10 64-bits. The SDK is located in the “CDROM \Demonstrations\TR5\PCIe\_SW\_KIT” folder which includes:

- PCI Express Driver
- PCI Express Library

- PCI Express Examples

The kernel mode driver assumes the PCIe vendor ID (VID) is 0x1172 and the device ID (DID) is 0xE003. If different VID and DID are used in the design, users need to modify the PCIe vendor ID (VID) and device ID (DID) in the driver INF file accordingly.

The PCI Express Library is implemented as a single DLL called TERASIC\_PCIE\_AVMM.DLL. This file is a 64-bits DLL. With the DLL exported to the software API, users can easily communicate with the FPGA. The library provides the following functions:

- Basic Data Read and Write
- Data Read and Write by DMA

For high performance data transmission, DMA is required as the read and write operations are specified under the hardware design on the FPGA.

## ■ PCI Express Software Stack

**Figure 7-8** shows the software stack for the PCI Express application software on 64-bit Windows. The PCI Express driver incorporated in the DLL library is called TERASIC\_PCIE\_AVMM.dll. Users can develop their applications based on this DLL. The altera\_pcie\_win\_driver.sys kernel driver is provided by Altera.



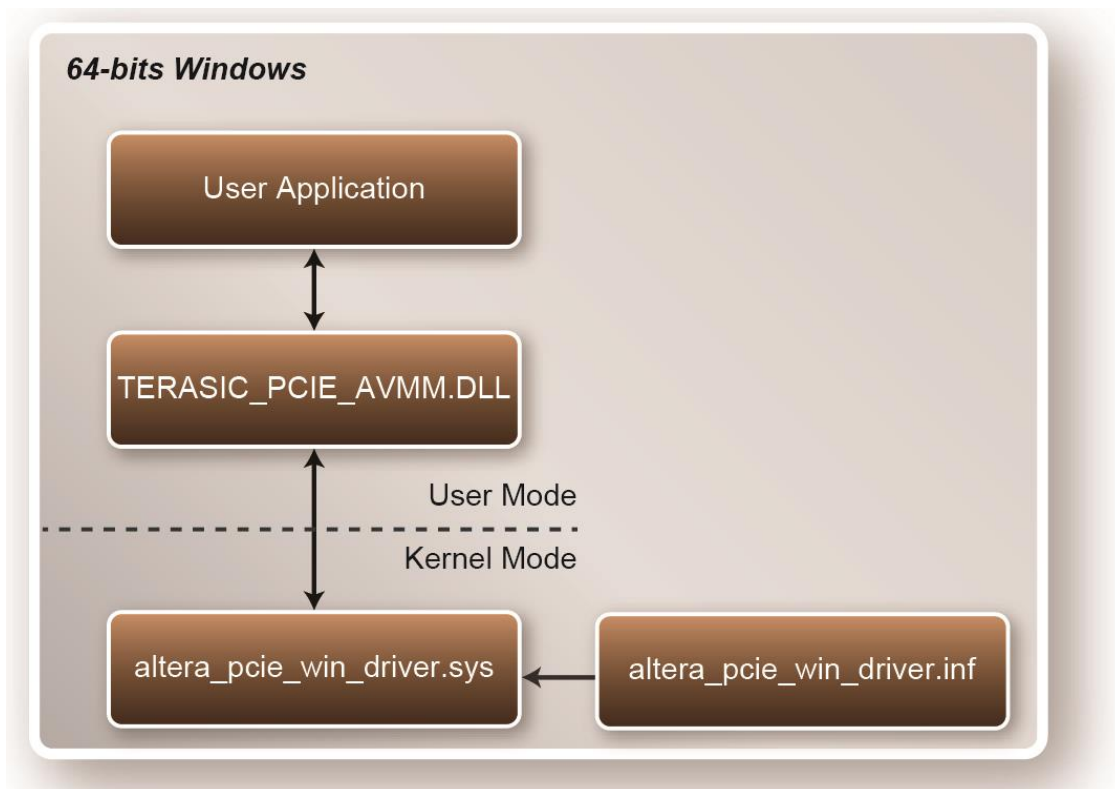

**Figure 4-1 PCI Express Software Stack**

## ■ Install PCI Express Driver on Windows

The PCIe driver is located in the folder:

“CDROM\Demonstrations\TR5\PCIe\_SW\_KIT\PCIe\_Driver “

The folder includes the following four files:

- Altera\_pcie\_win\_driver.cat
- Altera\_pcie\_win\_driver.inf
- Altera\_pcie\_win\_driver.sys
- WdfCoinstaller01011.dll

To install the PCI Express driver, execute the steps below:

1. Make sure the TR5 and the PC are both powered off.
2. Plug the PCIe adapter card(**PCA3**) into the PCIe slot on the PC motherboard. Use the PCIe cable to connect to the TR5 PCIE connector and the **PCA3** (See **Figure 4-2** )

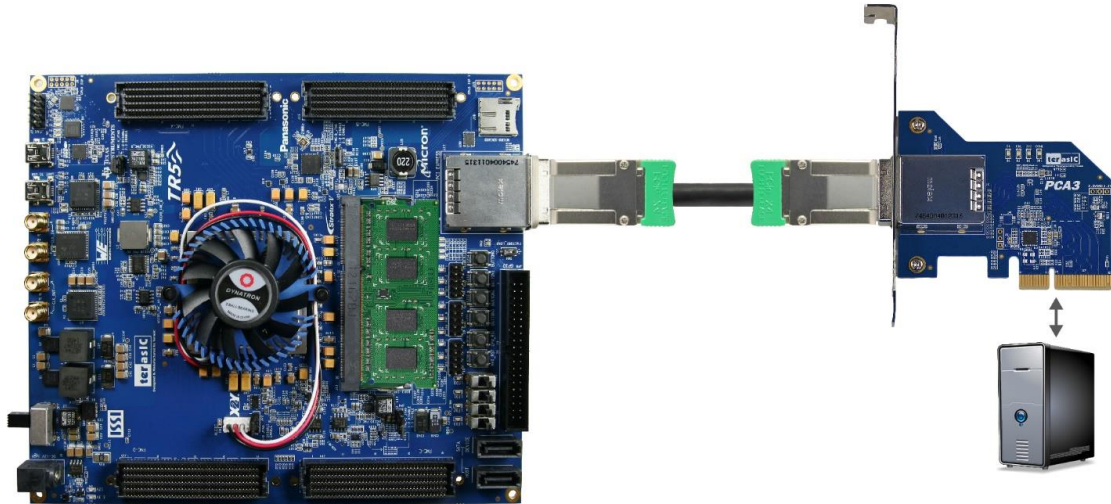

**Figure 4-2 FPGA board connect to PC**

3. Power on your TR5 board and the host PC
4. Make sure Altera Programmer and USB-Blaster II driver are installed
5. Execute test.bat in “CDROM\Demonstrations\TR5\PCIE\_Fundamental\demo\_batch” to configure the FPGA
6. Restart windows Operation System
7. Click the Control Panel menu from the Windows Start menu. Click the Hardware and the Sound item before clicking the Device Manager to launch the Device Manager dialog. There will be a PCI Device item in the dialog, as shown in **Figure 4-3**. Move the mouse cursor to the PCI Device item and right click it to select the Update Driver Software... item.

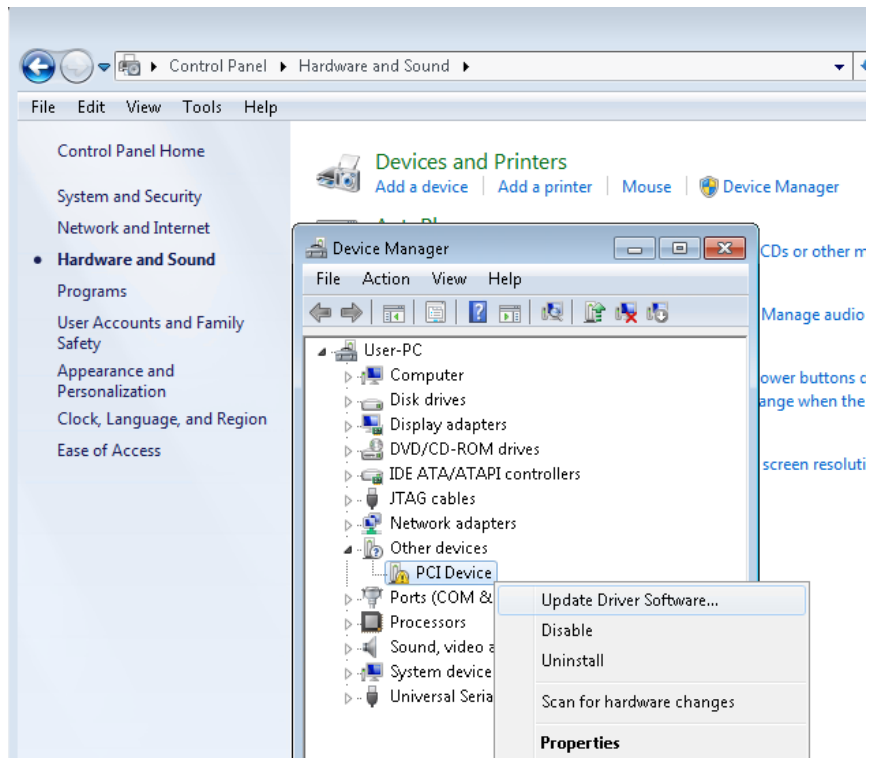

**Figure 4-3 Screenshot of launching Update Driver Software dialog**

8. In the **How do you want to search for driver software** dialog, click **Browse my computer for driver software** item, as shown in **Figure 4-4**. Click “OK” and then “Exit” to close the installation program.

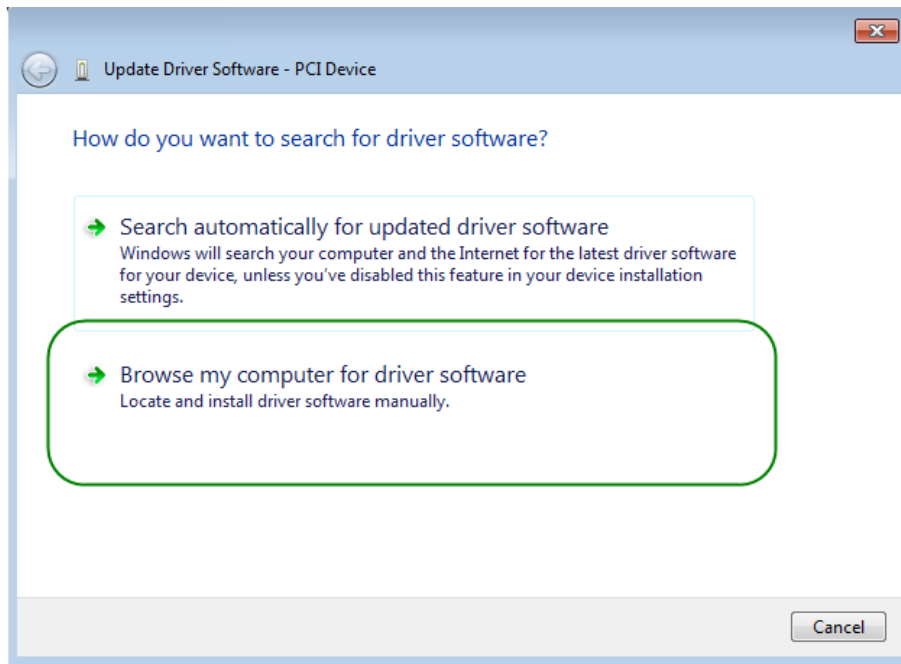

**Figure 4-4 Dialog of Browse my computer for driver software**

9. In the **Browse for driver software on your computer** dialog, click the **Browse** button to specify the folder where altera\_pcie\_din\_driver.inf is located, as shown in **Figure 4-5** Click the **Next** button.

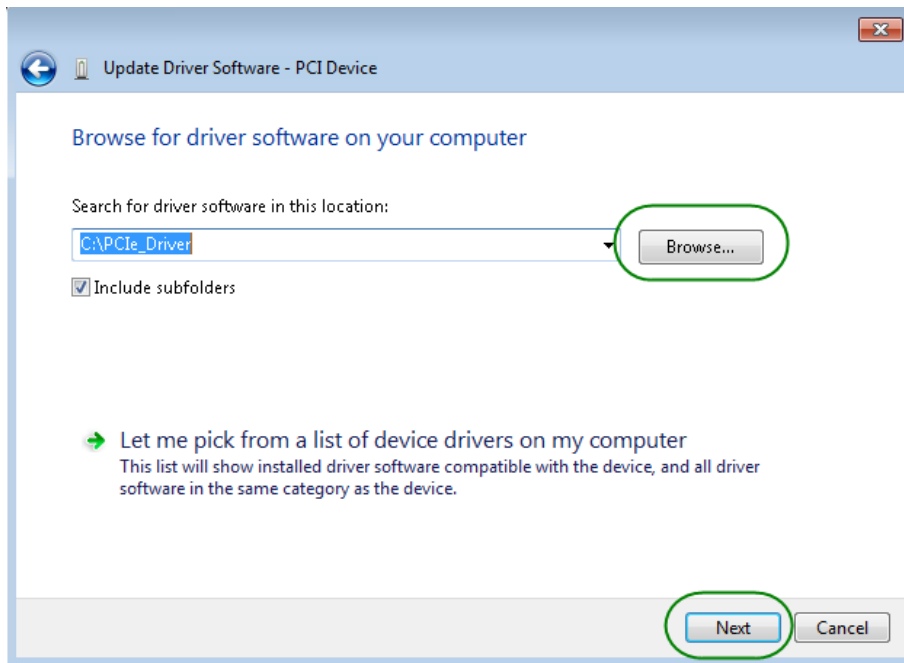

**Figure 4-5 Browse for driver software on your computer**

10. When the **Windows Security** dialog appears, as shown [Figure 4-6](#) , click the **Install** button.

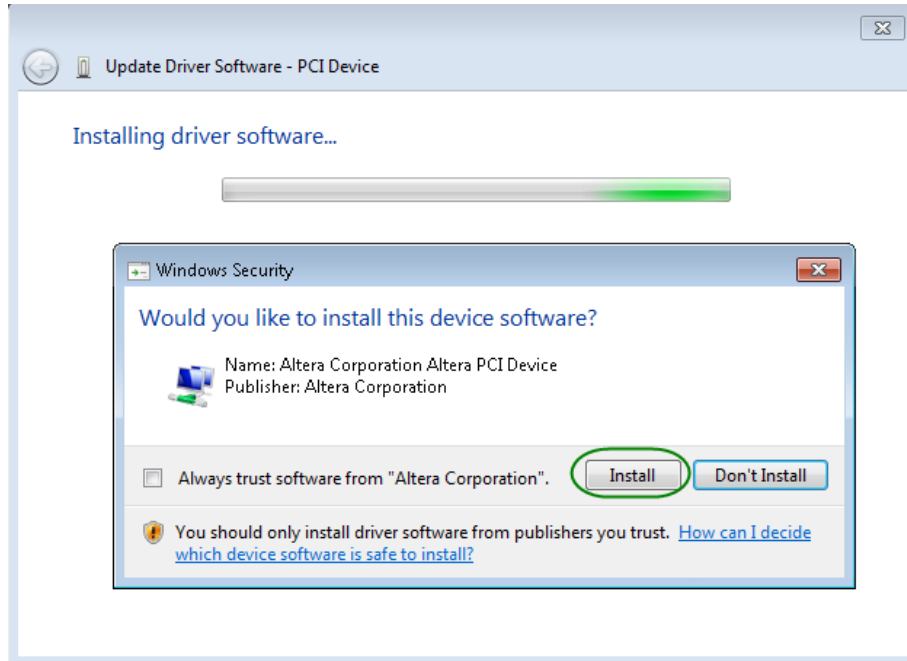

**Figure 4-6 Click Install in the dialog of Windows Security**

11. When the driver is installed successfully, the successfully dialog will appear, as shown in [Figure 4-7](#). Click the **Close** button.

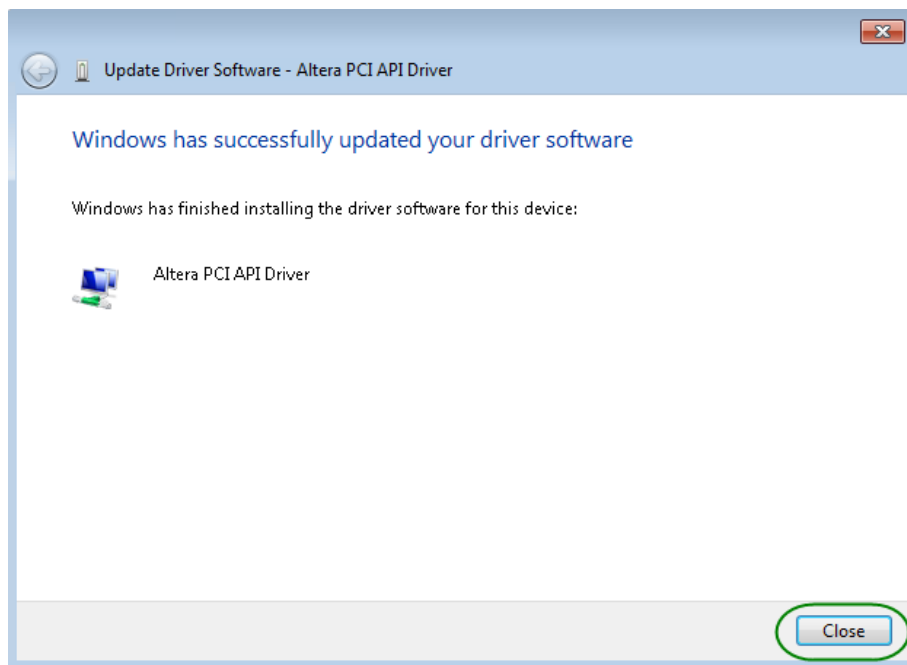



**Figure 4-7 Click Close when the installation of Altera PCI API Driver is complete**

12. Once the driver is successfully installed, users can see the **Altera PCI API Driver** under the device manager window, as shown in **Figure 4-8**.

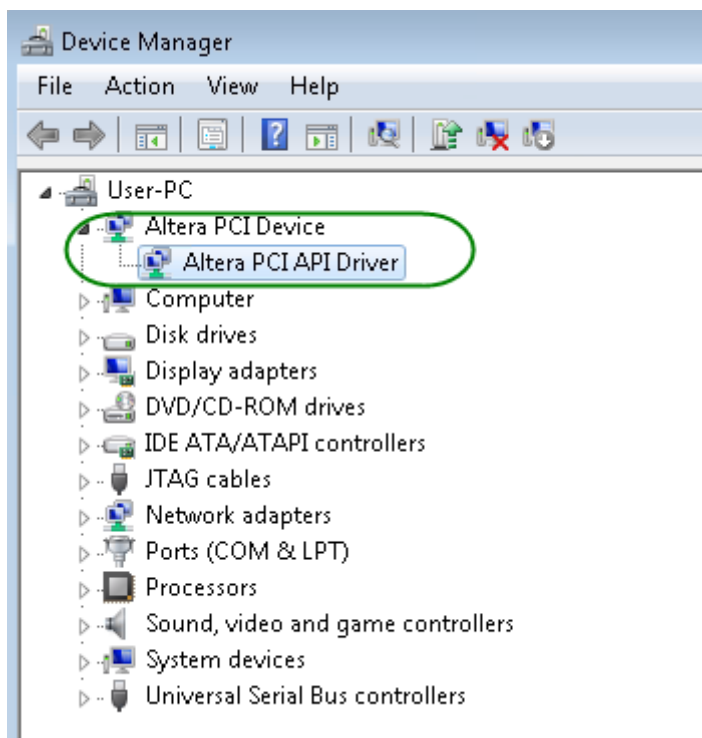

**Figure 4-8 Altera PCI API Driver in Device Manager**

## ■ Create a Software Application

All necessary files to create a PCIe software application are located in the *CDROM\Demonstration\TR5\PCIe\_SW\_KIT\PCIe\_Library*, the files are as follows:

- TERASIC\_PCIE\_AVMM.h
- TERASIC\_PCIE\_AVMM.DLL (64-bit DLL)

Below lists the procedures to use the SDK files in users' C/C++ project :

- Create a 64-bit C/C++ project.
- Include TERASIC\_PCIE\_AVMM.h in the C/C++ project.

- Copy TERASIC\_PCIE\_AVMM.DLL to the folder where the project.exe is located.
- Dynamically load TERASIC\_PCIE\_AVMM.DLL in C/C++ program. To load the DLL, please refer to the PCIe fundamental example below.
- Call the SDK API to implement the desired application.
- TERASIC\_PCIE.DLL/TERASIC\_PCIEx64.DLL Software API

Users can easily communicate with the FPGA through the PCIe bus through the TERASIC\_PCIE\_AVMM.DLL API. The details of API are described below:

## ■ PCIE\_Open

<b>Function:</b>	Open a specified PCIe card with vendor ID, device ID, and matched card index.
<b>Prototype:</b>	<pre>PCIE_HANDLE PCIE_Open(     WORD wVendorID,     WORD wDeviceID,     WORD wCardIndex);</pre>
<b>Parameters:</b>	<p>wVendorID: Specify the desired vendor ID. A zero value means to ignore the vendor ID.</p> <p>wDeviceID: Specify the desired device ID. A zero value means to ignore the device ID.</p> <p>wCardIndex: Specify the matched card index, a zero based index, based on the matched vendor ID and device ID.</p>
<b>Return Value:</b>	<p>Return a handle to presents specified PCIe card. A positive value is return if the PCIe card is opened successfully. A value zero means failed to connect the target PCIe card.</p> <p>This handle value is used as a parameter for other functions, e.g. PCIE_Read32.</p> <p>Users need to call PCIE_Close to release handle once the handle is no more used.</p>

## ■ PCIE\_Close

<b>Function:</b>	Close a handle associated to the PCIe card.
<b>Prototype:</b>	<pre>void PCIE_Close(     PCIE_HANDLE hPCIE);</pre>
<b>Parameters:</b>	<p>hPCIE:</p>

A PCIe handle return by PCIE\_Open function.

**Return Value:**

None.

## ■ PCIE\_Read32

**Function:**

Read a 32-bit data from the FPGA board.

**Prototype:**

```
bool PCIE_Read32(  
    PCIE_HANDLE hPCIE,  
    PCIE_BAR PcieBar,  
    PCIE_ADDRESS PcieAddress,  
    DWORD * pdwData);
```

**Parameters:**

**hPCIE:**  
A PCIe handle return by PCIE\_Open function.

**PcieBar:**  
Specify the target BAR.

**PcieAddress:**  
Specify the target address in FPGA.

**pdwData:**  
A buffer to retrieve the 32-bit data.

**Return Value:**

Return TRUE if read data is successful; otherwise FALSE is returned.

## ■ PCIE\_Write32

**Function:**

Write a 32-bit data to the FPGA Board.

**Prototype:**

```
bool PCIE_Write32(  
    PCIE_HANDLE hPCIE,  
    PCIE_BAR PcieBar,  
    PCIE_ADDRESS PcieAddress,  
    DWORD dwData);
```

**Parameters:**

**hPCIE:**

A PCIe handle return by PCIE\_Open function.

**PcieBar:**

Specify the target BAR.

**PcieAddress:**

Specify the target address in FPGA.

**dwData:**

Specify a 32-bit data which will be written to FPGA board.

**Return Value:**

Return TRUE if write data is successful; otherwise FALSE is returned.

## ■ PCIE\_DmaRead

**Function:**

Read data from the memory-mapped memory of FPGA board in DMA.

**Prototype:**

```
bool PCIE_DmaRead(  
    PCIE_HANDLE hPCIE,  
    PCIE_LOCAL_ADDRESS LocalAddress,  
    void *pBuffer,  
    DWORD dwBufSize  
);
```

**Parameters:**

**hPCIE:**

A PCIe handle return by PCIE\_Open function.

**LocalAddress:**

Specify the target memory-mapped address in FPGA.

**pBuffer:**

A pointer to a memory buffer to retrieved the data from FPGA. The size of buffer should be equal or larger the dwBufSize.

**dwBufSize:**

Specify the byte number of data retrieved from FPGA.

**Return Value:**

Return TRUE if read data is successful; otherwise FALSE is returned.

## ■ PCIE\_DmaWrite

**Function:**

Write data to the memory-mapped memory of FPGA board in DMA.

**Prototype:**

```
bool PCIE_DmaWrite(  
    PCIE_HANDLE hPCIE,  
    PCIE_LOCAL_ADDRESS LocalAddress,  
    void *pData,  
    DWORD dwDataSize  
);
```

**Parameters:**

hPCIE:

A PCIe handle return by PCIE\_Open function.

LocalAddress:

Specify the target memory mapped address in FPGA.

pData:

A pointer to a memory buffer to store the data which will be written to FPGA.

dwDataSize:

Specify the byte number of data which will be written to FPGA.

**Return Value:**

Return TRUE if write data is successful; otherwise FALSE is returned.

## ■ PCIE\_ConfigRead32

**Function:**

Read PCIe Configuration Table. Read a 32-bit data by given a byte offset.

**Prototype:**

```
bool PCIE_ConfigRead32 (  
    PCIE_HANDLE hPCIE,  
    DWORD Offset,  
    DWORD *pdwData  
);
```

**Parameters:**

hPCIE:

A PCIe handle return by PCIE\_Open function.

Offset:

Specify the target byte of offset in PCIe configuration table.

pdwData:

A 4-bytes buffer to retrieve the 32-bit data.

**Return Value:**

Return TRUE if read data is successful; otherwise FALSE is returned.

## 4.3 Reference Design - Fundamental

The application reference design shows how to implement fundamental control and data transfer in DMA. In the design, basic I/O is used to control the BUTTON and LED on the FPGA board. High-speed data transfer is performed by DMA.

### ■ Demonstration Files Location

- The demo file is located in the batch folder:
  - CDROM\demonstrations\TR5\PCIE\_fundamental\Demo\_batch
- The folder includes following files:
  - FPGA Configuration File: PCIE\_fundamental.sof
  - Download Batch file: test.bat
  - Windows Application Software folder : windows\_app, includes
    - ◆ PCIE\_FUNDAMENTAL.exe
    - ◆ TERASIC\_PCIE\_AVMM.dll

### ■ Demonstration Setup

1. Use the PCIe cable to connect to the TR5 PCIE connector and PCIe adapter card as shown in **Figure 4-9**.

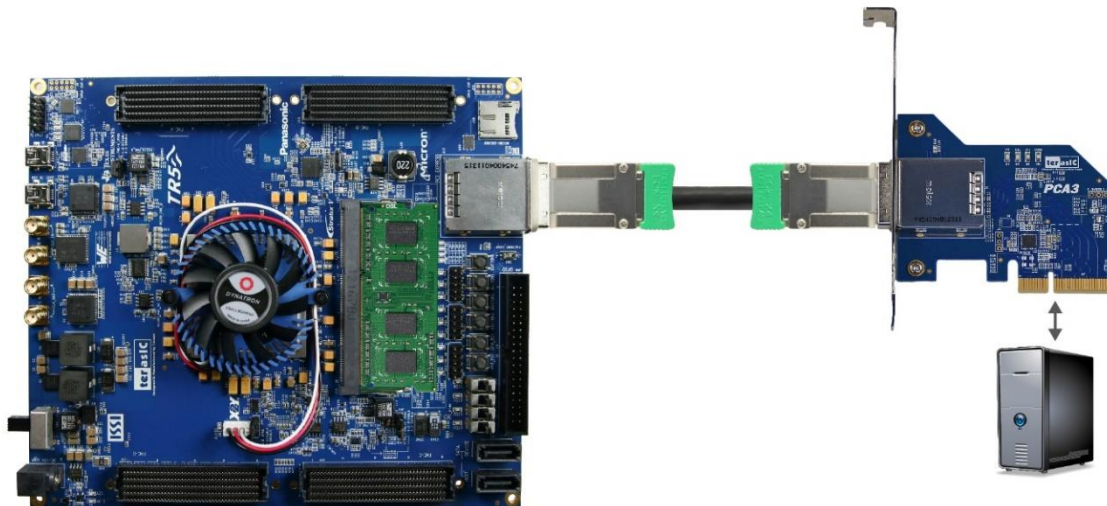

**Figure 4-9 FPGA board connect to PC**

2. Configure FPGA with PCIE\_Fundamental.sof by executing the test.bat.
3. Install PCIe driver if necessary. The driver is located in the folder:  
CDROM\Demonstration\TR5\PCIE\_SW\_KIT\PCIE\_Driver.
4. Restart Windows
5. Make sure the Windows has detected the FPGA Board by checking the Windows Control panel as shown in **Figure 4-10**.

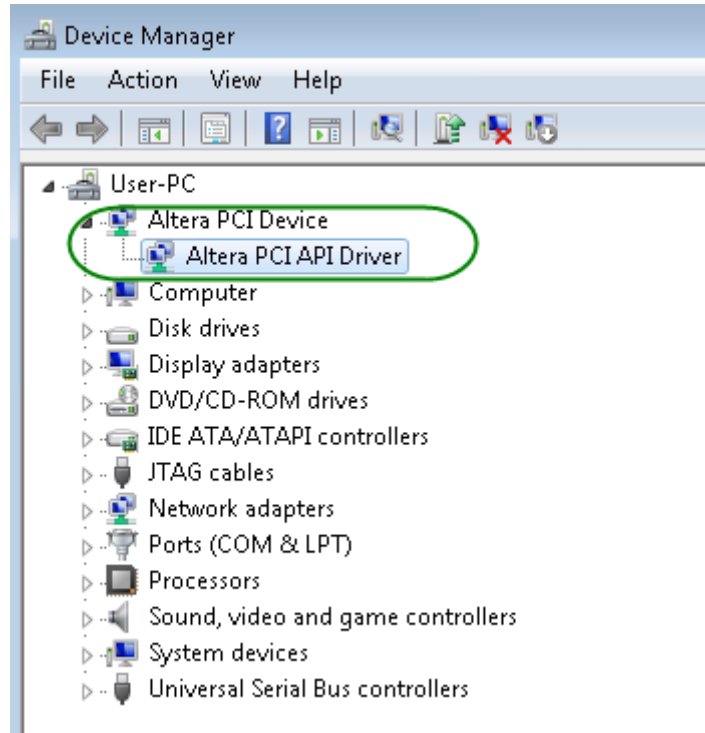

**Figure 4-10 Screenshot for PCIe Driver**

6. Go to windows\_app folder, execute PCIE\_FUNDMENTAL.exe. A menu will appear as shown in **Figure 4-11**.

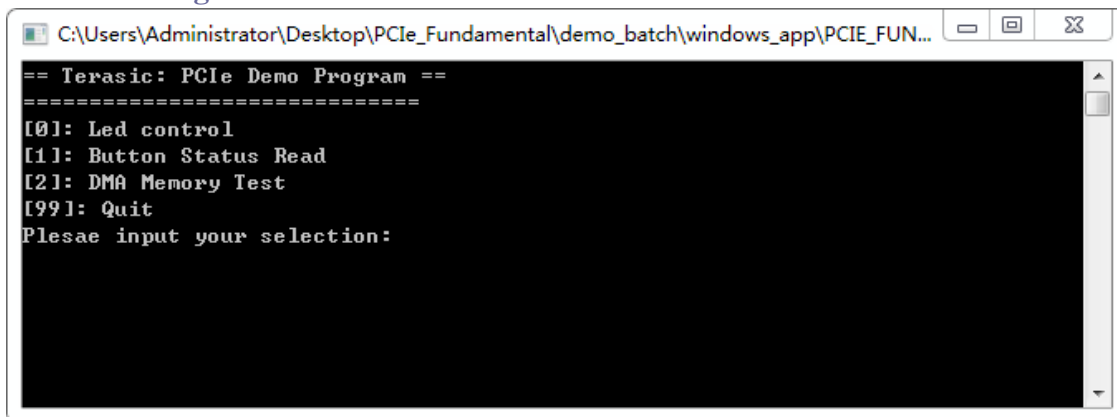
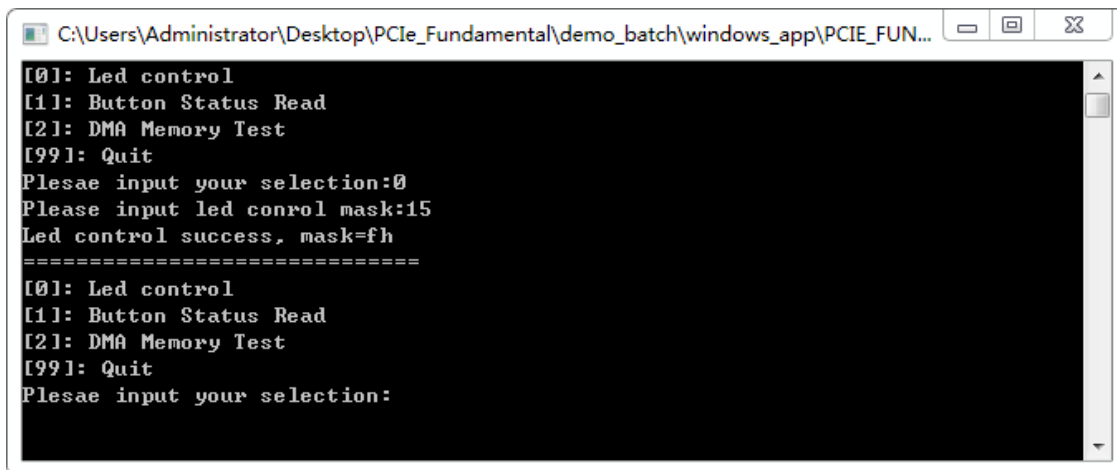

**Figure 4-11 Screenshot of Program Menu**

7. Type 0 followed by a ENTER key to select Led Control item, then input 15 (hex 0x0f) will make all led on as shown in **Figure 4-12**. If input 0(hex 0x00), all led will be



turned off.



```
C:\Users\Administrator\Desktop\PCIE_Fundamental\demo_batch\windows_app\PCIE_FUN...
[0]: Led control
[1]: Button Status Read
[2]: DMA Memory Test
[99]: Quit
Plesae input your selection:0
Please input led control mask:15
Led control success, mask=fh
=====
[0]: Led control
[1]: Button Status Read
[2]: DMA Memory Test
[99]: Quit
Plesae input your selection:
```

**Figure 4-12 Screenshot of LED Control**

8. Type 1 followed by an ENTER key to select Button Status Read item. The button status will be reported as shown in Figure 4-13.

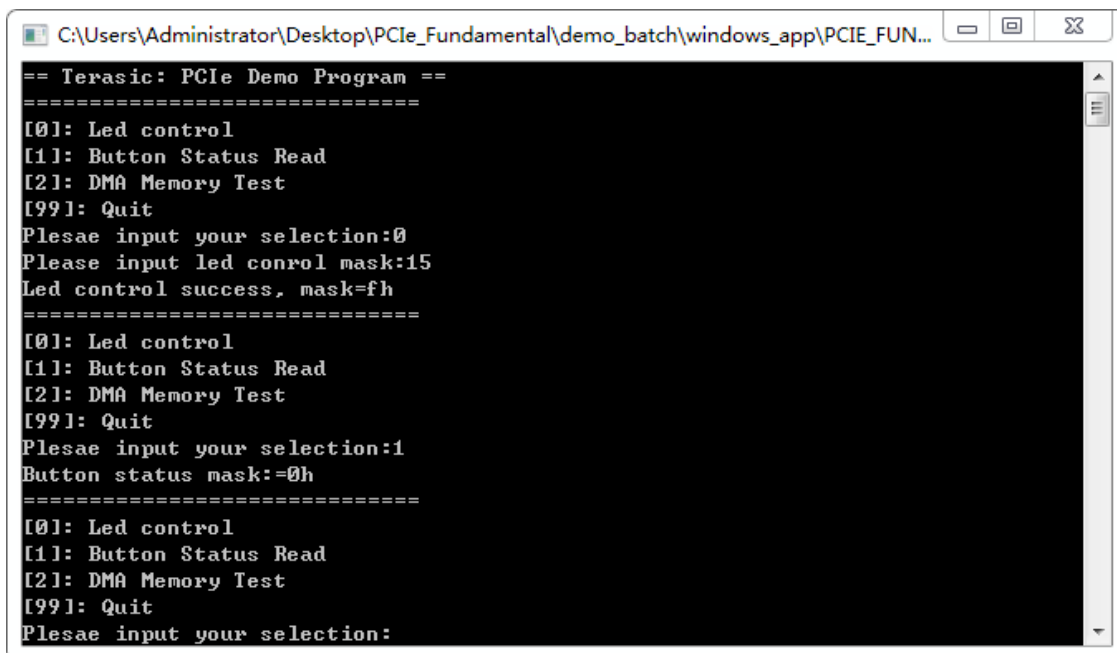

```
C:\Users\Administrator\Desktop\PCIE_Fundamental\demo_batch\windows_app\PCIE_FUN...
== Terasic: PCIe Demo Program ==
=====
[0]: Led control
[1]: Button Status Read
[2]: DMA Memory Test
[99]: Quit
Plesae input your selection:0
Please input led control mask:15
Led control success, mask=fh
=====
[0]: Led control
[1]: Button Status Read
[2]: DMA Memory Test
[99]: Quit
Plesae input your selection:1
Button status mask:=0h
=====
[0]: Led control
[1]: Button Status Read
[2]: DMA Memory Test
[99]: Quit
Plesae input your selection:
```

**Figure 4-13 Screenshot of Button Status Report**

9. Type-2 followed by an ENTER key to select DMA Testing item. The DMA test result will be reported as shown in Figure 4-14.

```
C:\Users\Administrator\Desktop\PCIE_Fundamental\demo_batch\windows_app\PCIE_FUN...
== Terasic: PCIe Demo Program ==
=====
[0]: Led control
[1]: Button Status Read
[2]: DMA Memory Test
[99]: Quit
Plesae input your selection:0
Please input led control mask:15
Led control success, mask=fh
=====
[0]: Led control
[1]: Button Status Read
[2]: DMA Memory Test
[99]: Quit
Plesae input your selection:1
Button status mask:=0h
=====
[0]: Led control
[1]: Button Status Read
[2]: DMA Memory Test
[99]: Quit
Plesae input your selection:2
DMA-Memory (Size = 524288 bytes) pass
=====
[0]: Led control
[1]: Button Status Read
[2]: DMA Memory Test
[99]: Quit
Plesae input your selection:
```

**Figure 4-14 Screenshot of DMA Memory Test Result**

10. Type 99 followed by an ENTER key to exit this test program

## ■ Development Tools

- Quartus II 16.0
- Visual C++ 2012

## ■ Demonstration Source Code Location

- Quartus Project: Demonstrations\TR5\PCIE\_Fundamental
- Visual C++ Project: Demonstrations\TR5\PCIE\_SW\_KIT\PCIE\_FUNDAMENTAL

## ■ FPGA Application Design

Figure 4-15 shows the system block diagram in the FPGA system. In the Qsys, Altera PIO controller is used to control the LED and monitor the Button Status, and the On-Chip memory is used for performing DMA testing. The PIO controllers and the On-Chip memory are connected to the PCI Express Hard IP controller through the Memory-Mapped Interface.

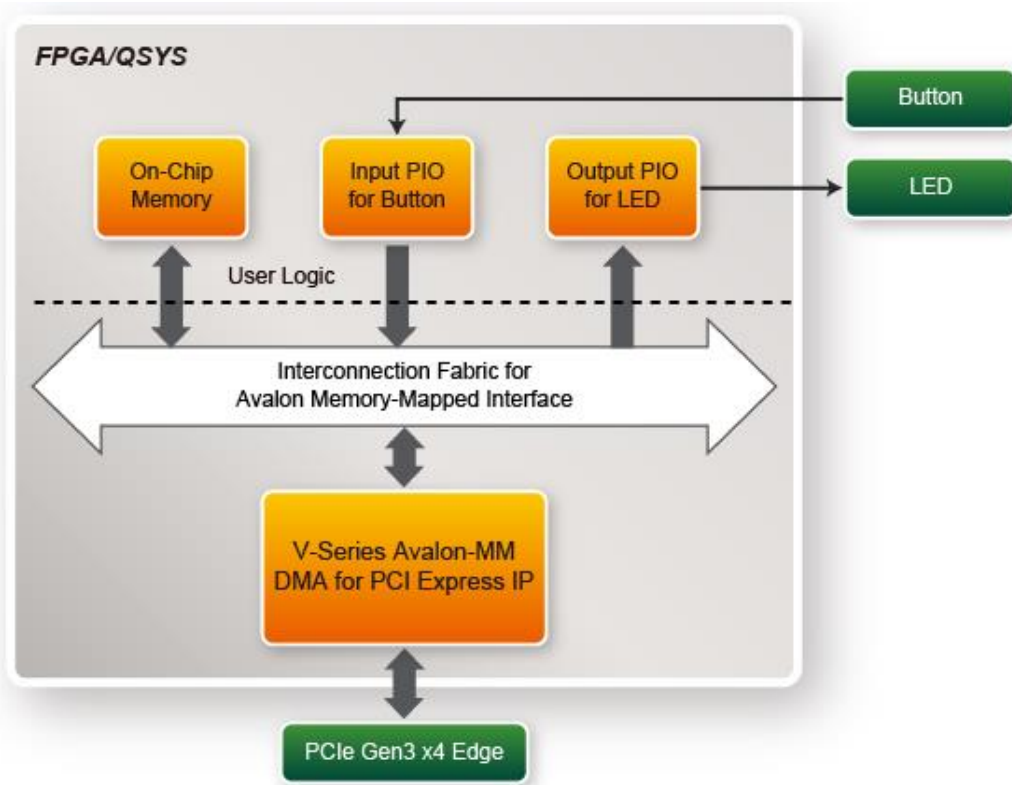

Figure 4-15 Hardware block diagram of the PCIe reference design

## ■ Windows Based Application Software Design

The application software project is built by Visual C++ 2012. The project includes the following major files:

Name	Description
PCIE_FUNDAMENTAL.cpp	Main program

PCIE.c	Implement dynamically load for
PCIE.h	TERASIC_PCIE_AVMM.DLL
TERASIC_PCIE_AVMM.h	SDK library file, defines constant and data structure

The main program PCIE\_FUNDAMENTAL.cpp includes the header file "PCIE.h" and defines the controller address according to the FPGA design.

```
#define DEMO_PCIE_USER_BAR          PCIE_BAR4
#define DEMO_PCIE_IO_LED_ADDR       0x4000010
#define DEMO_PCIE_IO_BUTTON_ADDR    0x4000020
#define DEMO_PCIE_MEM_ADDR          0x00000000

#define MEM_SIZE                     (512*1024) //512KB
```

The base address of BUTTON and LED controllers are 0x4000010 and 0x4000020 based on PCIE\_BAR4, respectively. The on-chip memory base address is 0x00000000 relative to the DMA controller.

Before accessing the FPGA through PCI Express, the application first calls PCIE\_Load to dynamically load the TERASIC\_PCIE\_AVMM.DLL. Then, it calls the PCIE\_Open to open the PCI Express driver. The constant DEFAULT\_PCIE\_VID and DEFAULT\_PCIE\_DID used in PCIE\_Open are defined in TERASIC\_PCIE\_AVMM.h. If developer changes the Vendor ID, the Device ID, and the PCI Express IP, they also need to change the ID value defined in TERASIC\_PCIE\_AVMM.h. If the return value of the PCIE\_Open is zero, it means the driver cannot be accessed successfully. In this case, please make sure:

- The FPGA is configured with the associated bit-stream file and the host is rebooted.
- The PCI express driver is loaded successfully.

The LED control is implemented by calling PCIE\_Write32 API, as shown below:

```
bPass = PCIE_Write32(hPCIE, DEMO_PCIE_USER_BAR, DEMO_PCIE_IO_LED_ADDR, (DWORD)Mask);
```

The button status query is implemented by calling the PCIE\_Read32 API, as shown below:

```
PCIE_Read32(hPCIE, DEMO_PCIE_USER_BAR, DEMO_PCIE_IO_BUTTON_ADDR, &Status);
```

The memory-mapped memory read and write test is implemented by PCIE\_DmaWrite and PCIE\_DmaRead API, as shown below:

```
PCIE_DmaWrite(hPCIE, LocalAddr, pWrite, nTestSize);  
  
PCIE_DmaRead(hPCIE, LocalAddr, pRead, nTestSize);
```

## 4.4 PCIe Reference Design – DDR3

The application reference design shows how to add DDR3 Memory Controllers into the PCIe Quartus project based on the PCI\_Fundamental Quartus project and perform 2GB data DMA for both SODIMM. Also, this demo shows how to call “PCIE\_ConfigRead32” API to check PCIe link status.

### ■ Demonstration Files Location

- The demo file is located in the batch folder:
  - CDRM\Demonstrations\TR5\PCIe\_DDR3\Demo\_batch
- The folder includes following files:
  - FPGA Configuration File: PCIe\_DDR3.sof
  - Download Batch file: test.bat
  - Windows Application Software folder: windows\_app, includes
    - ◆ PCIE\_DDR3.exe
    - ◆ TERASIC\_PCIE\_AVMM.dll

### ■ Demonstration Setup

1. Install both DDR3 1600 2GB SODIMM on the FPGA board.
2. Use the PCIe cable to connect to the TR5 PCIe connector and PCIe adapter card.
3. Configure FPGA with PCIe\_DDR3.sof by executing the test.bat.
4. Install PCIe driver if necessary.
5. Restart Windows
6. Make sure the Windows has detected the FPGA Board by checking the Windows Control panel.

7. Goto windows\_app folder, execute PCIE\_DDR3.exe. A menu will appear as shown in **Figure 4-16**.

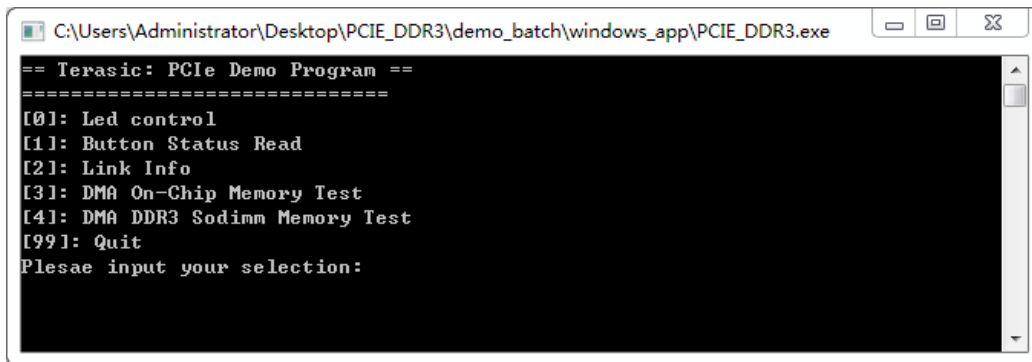

**Figure 4-16 Screenshot of Program Menu**

8. Type 2 followed by the ENTER key to select Link Info item. The PICe link information will be shown as in **Figure 4-17**. Gen3 link speed and x4 link width are expected.

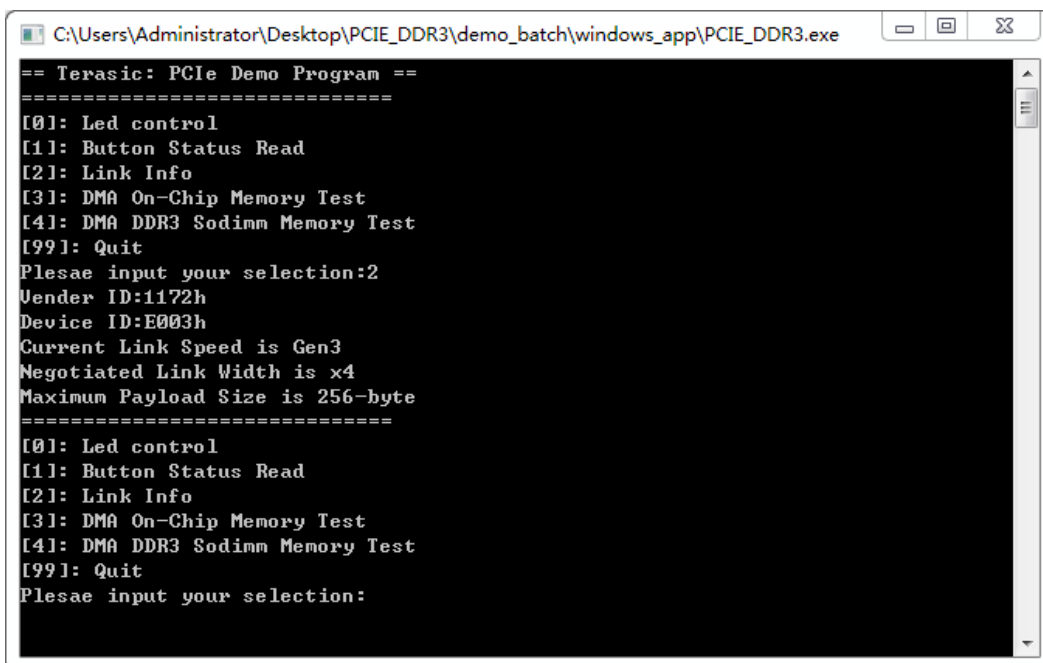

**Figure 4-17 Screenshot of Link Info**

9. Type 3 followed by the ENTER key to select DMA On-Chip Memory Test item. The DMA write and read test result will be reported as shown in **Figure 4-18**.

```
C:\Users\Administrator\Desktop\PCIE_DDR3\demo_batch\windows_app\PCIE_DDR3.exe
Maximum Payload Size is 256-byte
=====
[0]: Led control
[1]: Button Status Read
[2]: Link Info
[3]: DMA On-Chip Memory Test
[4]: DMA DDR3 Sodimm Memory Test
[99]: Quit
Plesae input your selection:3
DMA Memory Test, size=524288dBytes...
Generate Test Pattern...
DMA Write...
DMA Read...
Readback Data Verify...
DMA-Memory (Size = 524288d bytes) pass
=====
[0]: Led control
[1]: Button Status Read
[2]: Link Info
[3]: DMA On-Chip Memory Test
[4]: DMA DDR3 Sodimm Memory Test
[99]: Quit
Plesae input your selection:
```

Figure 4-18 Screenshot of On-Chip Memory DMA Test Result

- 10. Type-4 followed by the ENTER key to select DMA DDR3 SODIMM Memory Test item. The DMA write and read test result will be report as shown in Figure 4-19.

```
C:\Users\Administrator\Desktop\PCIE_DDR3\demo_batch\windows_app\PCIE_DDR3.exe
DMA-Memory (Size = 524288d bytes) pass
=====
[0]: Led control
[1]: Button Status Read
[2]: Link Info
[3]: DMA On-Chip Memory Test
[4]: DMA DDR3 Sodimm Memory Test
[99]: Quit
Plesae input your selection:4
DMA Memory Test, size=2147483648dBytes...
Generate Test Pattern...
DMA Write...
DMA Read...
Readback Data Verify...
DMA-Memory (Size = 2147483648d bytes) pass
=====
[0]: Led control
[1]: Button Status Read
[2]: Link Info
[3]: DMA On-Chip Memory Test
[4]: DMA DDR3 Sodimm Memory Test
[99]: Quit
Plesae input your selection:
```

Figure 4-19 Screenshot of DDR3 SOSIMM Memory DAM Test Result

- 11. Type 99 followed by the ENTER key to exit this test program.



## ■ Development Tools

- Quartus II 16.0
- Visual C++ 2012

## ■ Demonstration Source Code Location

- Quartus Project: Demonstrations\TR5\PCIE\_DDR3
- Visual C++ Project: Demonstrations\TR5\PCie\_SW\_KIT\PCie\_DDR3

## ■ FPGA Application Design

**Figure 4-20** shows the system block diagram in the FPGA system. In the Qsys, Altera PIO controller is used to control the LED and monitor the Button Status, and the On-Chip memory and DDR3 SODIMM Memory are used for performing DMA testing. The PIO controllers, the On-Chip memory and DDR3 SODIMM Memory are connected to the PCI Express Hard IP controller through the Memory-Mapped Interface.

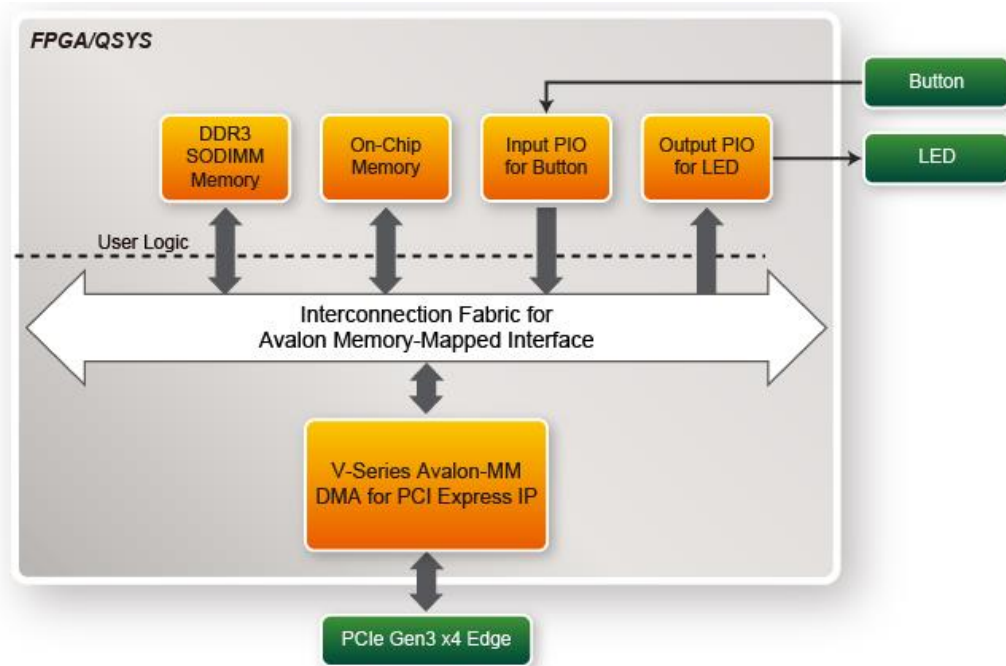

Figure 4-20 Hardware block diagram of the PCIe DDR3 reference design

## ■ Windows Based Application Software Design

The application software project is built by Visual C++ 2012. The project includes the following major files:

Name	Description
PCIE_DDR3.cpp	Main program
PCIE.c	Implement dynamically load for
PCIE.h	TERAISC_PCIE_AVMM.DLL
TERASIC_PCIE_AVMM.h	SDK library file, defines constant and data structure

The main program PCIE\_DDR3.cpp includes the header file "PCIE.h" and defines the controller address according to the FPGA design.

```

#define DEMO_PCIE_USER_BAR          PCIE_BAR4
#define DEMO_PCIE_IO_LED_ADDR       0x4000010
#define DEMO_PCIE_IO_BUTTON_ADDR    0x4000020
#define DEMO_PCIE_ONCHIP_MEM_ADDR   0x00000000
#define DEMO_PCIE_DDR3_MEM_ADDR     0x1000000000

#define ONCHIP_MEM_TEST_SIZE        (512*1024) //512KB
#define DDR3_MEM_TEST_SIZE          (2*1024*1024*1024) //2GB

```

The base address of BUTTON and LED controllers are 0x4000010 and 0x4000020 based on PCIE\_BAR4, respectively. The on-chip memory base address is 0x00000000 relative to the DMA controller. **The above definition is the same as those in the PCIe Fundamental demo.**

Before accessing the FPGA through PCI Express, the application first calls PCIE\_Load to dynamically load the Terasic\_PCIE\_AVMM.DLL. Then, it calls PCIE\_Open to open the PCI Express driver. The constant DEFAULT\_PCIE\_VID and DEFAULT\_PCIE\_DID used in PCIE\_Open are defined in Terasic\_PCIE\_AVMM.h. If the developer changes the Vendor ID, Device ID, and PCI Express IP, they also need to change the ID value defined in Terasic\_PCIE\_AVMM.h. If the return value of PCIE\_Open is zero, it means the driver cannot be accessed successfully. In this case, please make sure:

- The FPGA is configured with the associated bit-stream file and the host is rebooted.
- The PCI express driver is loaded successfully.

The LED control is implemented by calling PCIE\_Write32 API, as shown below:

```

bPass = PCIE_Write32(hPCIE, DEMO_PCIE_USER_BAR, DEMO_PCIE_IO_LED_ADDR, (DWORD)Mask);

```

The button status query is implemented by calling the **PCIE\_Read32** API, as shown below:

```

PCIE_Read32(hPCIE, DEMO_PCIE_USER_BAR, DEMO_PCIE_IO_BUTTON_ADDR, &Status);

```

The memory-mapped memory read and write test is implemented by **PCIE\_DmaWrite** and **PCIE\_DmaRead** API, as shown below:

```

PCIE_DmaWrite(hPCIE, LocalAddr, pWrite, nTestSize);

PCIE_DmaWrite(hPCIE, LocalAddr, pWrite, nTestSize);

```

The pcie link information is implemented by PCIE\_ConfigRead32 API, as shown below:

```
// read config - link status
if (PCIE_ConfigRead32(hPCIE, 0x90, &Data32)){
    switch((Data32 >> 16) & 0x0F){
        case 1:
            printf("Current Link Speed is Gen1\r\n");
            break;
        case 2:
            printf("Current Link Speed is Gen2\r\n");
            break;
        case 3:
            printf("Current Link Speed is Gen3\r\n");
            break;
        default:
            printf("Current Link Speed is Unknown\r\n");
            break;
    }
    switch((Data32 >> 20) & 0x3F){
        case 1:
            printf("Negotiated Link Width is x1\r\n");
            break;
        case 2:
            printf("Negotiated Link Width is x2\r\n");
            break;
        case 4:
            printf("Negotiated Link Width is x4\r\n");
            break;
        case 8:
            printf("Negotiated Link Width is x8\r\n");
            break;
        case 16:
            printf("Negotiated Link Width is x16\r\n");
            break;
        default:
            printf("Negotiated Link Width is Unknown\r\n");
            break;
    }
}
}else{
    bPass = false;
}
```

## Chapter 5

# *Appendix*

---

### 5.1 Revision History

<i>Version</i>	<i>Change Log</i>
V1.0	Initial Version (Preliminary)
V1.1	Add section 1.1 package contents and modify

### 5.2 Copyright Statement

Copyright © 2017 Terasic Technologies. All rights reserved.



Компания «ЭлектроПласт» предлагает заключение долгосрочных отношений при поставках импортных электронных компонентов на взаимовыгодных условиях!

Наши преимущества:

- Оперативные поставки широкого спектра электронных компонентов отечественного и импортного производства напрямую от производителей и с крупнейших мировых складов;
- Поставка более 17-ти миллионов наименований электронных компонентов;
- Поставка сложных, дефицитных, либо снятых с производства позиций;
- Оперативные сроки поставки под заказ (от 5 рабочих дней);
- Экспресс доставка в любую точку России;
- Техническая поддержка проекта, помощь в подборе аналогов, поставка прототипов;
- Система менеджмента качества сертифицирована по Международному стандарту ISO 9001;
- Лицензия ФСБ на осуществление работ с использованием сведений, составляющих государственную тайну;
- Поставка специализированных компонентов (Xilinx, Altera, Analog Devices, Intersil, Interpoint, Microsemi, Aeroflex, Peregrine, Syfer, Eurofarad, Texas Instrument, Miteq, Cobham, E2V, MA-COM, Hittite, Mini-Circuits, General Dynamics и др.);

Помимо этого, одним из направлений компании «ЭлектроПласт» является направление «Источники питания». Мы предлагаем Вам помощь Конструкторского отдела:

- Подбор оптимального решения, техническое обоснование при выборе компонента;
- Подбор аналогов;
- Консультации по применению компонента;
- Поставка образцов и прототипов;
- Техническая поддержка проекта;
- Защита от снятия компонента с производства.



#### Как с нами связаться

**Телефон:** 8 (812) 309 58 32 (многоканальный)

**Факс:** 8 (812) 320-02-42

**Электронная почта:** [org@eplast1.ru](mailto:org@eplast1.ru)

**Адрес:** 198099, г. Санкт-Петербург, ул. Калинина, дом 2, корпус 4, литера А.