

## Current Sensor : F01P\*\*\*S05L



### Features:

- Backward compatible to F01PS05 series
- Anti-Surge current (4kAT, 8/20uS, single)
- Mounting area reduced ; pin compatible. Longitudinal dimension reduced
- Super precision & High Stability (low temperature, drift)
- Unipolar power voltage ; +5V
- Multi-range models
- F01P\*\*\*S05L series are designed by the pin compatibility as high-end models of S22P\*\*\*X05M2 series.

### Comparison of the main features of F\*\*\*\*\*S05L series

Series	Features
F01P***S05L	No reference access
F02P***S05L	No reference access. Ref In/Out
F03P***S05L	No reference access. Ref In/Out. Higher creep age and clearance distance.

\*\*\* = Rated Current Symbol

### Specification

	F01P***S05L
Maximum Peak Current	4kAT (2kAx2. Number of primary turns is two turns)
Rated Current If (***= rated current symbol)	6A(006) / 15A(015) / 25A(025) 50A(050)
Maximum Current	$\pm 20A(I_f=6A)$ / $\pm 51A(I_f=15A)$ / $\pm 85A(I_f=25A)$ / $\pm 150A(I_f=50A)$
Existence of reference access	0
Number of primary busbar	3 pcs
Clearance distance ; Primary ↔ Secondary	7.7 mm
Standards	UL508 (file#E243511) , EN501758, EN61010-1 , EN60950-1
Ambient Operating Temperature	-40°C ~ +105°C

### Mounting Area

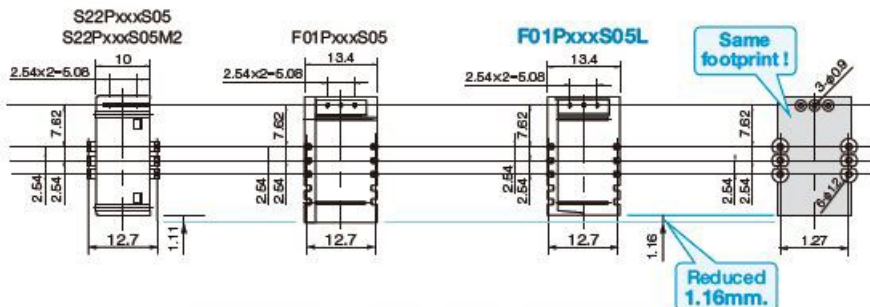

The mounting area has been reduced more than the F01P series. However, F01P\*\*\*S05L series are 100% compatible with original footprint mounting.

The F02P/F03PxxxS05L series also similarly reduces the mounting area.

## Current Sensor : F01P\*\*\*S05L

### Absolute Maximum Rating

	Symbol	Unit	Value	Notes
Supply Voltage	Vcc	V	7	
Primary Conductor Temperature	-	°C	110	
ESD (HBM: Human Body Model)	-	kV	4	C=100pF , R=1.5kΩ
Maximum Peak Current	-	kAT	4	Current Waveform : <ul style="list-style-type: none"> <li>• Front time 8μs</li> <li>• Time to half value 20μs</li> <li>• Single</li> </ul>

### Isolation Characteristics

	Symbol	Unit	Value	Notes
Insulation Voltage	Vd	-	AC4200V for 1 min. (Sensing Current 0.5mA)	Primary↔Secondary
Insulation Resistance	Ris	-	≥500mΩ (@DC500V)	Primary↔Secondary
Clearance distance	dCi	-	7.7mm (TYP)	Primary↔Secondary
Creep age distance	dCp	-	7.7mm (TYP)	Primary↔Secondary
Case material	-	-	UL94 V-0	
Comparative Tracking Index (CTI)	CTI	V	600	
Application Example	-	-	300V , CAT III , PD2	Reinforced Isolation Non uniform field according to EN50178 , EN61010
	-	-	600V , CAT III , PD2	Simple isolation Non uniform field according to EN50178 , EN61010

### Environmental and Mechanical Characteristics

	Symbol	Unit	Value		
			min	typ	max
Ambient Operating Temperature	Ta	°C	- 40		+ 105
Ambient Storage Temperature	Ts	°C	- 40		+105
Mass	-	g		12	

## Current Sensor : F01P\*\*\*S05L

### Specification

(\*1) = Offset voltage value is after removal of core hysteresis

		Symbol	Unit	Value			Notes
				min	typ	max	
Rated Current	F01P006S05L	If	A		6		
	F01P015S05L				15		
	F01P025S05L				25		
	F01P050S05L				50		
Maximum Current (@ Vcc : +5V , Ta : +105°C)	F01P006S05L	Ipmax	A	- 20		20	
	F01P015S05L			- 51		51	
	F01P025S05L			- 85		85	
	F01P050S05L			- 150		150	
Supply Voltage		Vcc	V	4.75	5.00	5.25	
Number of primary turns		Np	T	1,2,3			
Number of secondary turns	F01P006S05L	Ns	T		1816		
	F01P015S05L				1737		
	F01P025S05L				1764		
	F01P050S05L				1600		
Consumption current (at If)	F01P006S05L	Icc	mA		25		Icc=15+Ip(mA) / Ns
	F01P015S05L				30		
	F01P025S05L				35		
	F01P050S05L				55		
Output Voltage		Vo	V	0.375		4.625	
Output Voltage (Ip=0A)		Vo	V		2.5		
Electrical Offset Voltage (*1)	F01P006S05L	Voe	mV	- 10.40		10.40	
	F01P015S05L			- 7.10		7.10	
	F01P025S05L			- 6.25		6.25	
	F01P050S05L			- 5.80		5.80	
Electrical Offset Current referred to primary	F01P006S05L	loe	A	- 0.10		0.10	
	F01P015S05L			- 0.17		0.17	
	F01P025S05L			- 0.25		0.25	
	F01P050S05L			- 0.46		0.46	

## Current Sensor : F01P\*\*\*S05L

### Specification

		Symbol	Unit	Value			Notes
				min	typ	max	
Temperature coefficient of Output voltage (@ $I_p=0A$ )	F01P006S05L	TCVo	ppm/K		$\pm 10.0$	$\pm 80.0$	ppm/K of 2.5V ( $-40^{\circ}C \sim +105^{\circ}C$ )
	F01P015S05L				$\pm 7.5$	$\pm 70.0$	
	F01P025S05L				$\pm 6.5$	$\pm 60.0$	
	F01P050S05L				$\pm 6.0$	$\pm 60.0$	
Sensitivity (Theoretical value)	F01P006S05L	Gth	mV/A		104.2		625mV/If
	F01P015S05L				41.67		
	F01P025S05L				25		
	F01P050S05L				12.5		
Sensitivity Error		$\epsilon_G$	%	- 0.7		0.7	
Temperature coefficient of Sensitivity (@ $T_a=-40^{\circ}C \sim +105^{\circ}C$ )		TCG	ppm/K			$\pm 40$	
Output Linearity		$\epsilon_L$	%	- 0.1		0.1	
Magnetic offset current referred to primary (@ 10xf)		$I_{om}$	A	- 0.1		0.1	
Output current noise referred to primary (@ 100Hz~100kHz)	F01P006S05L	$I_{no}$	$\mu A / (Hz)^{1/2}$		36		RL=1k $\Omega$
	F01P015S05L				90		
	F01P025S05L				150		
	F01P050S05L				300		
Peak to peak output ripple at oscillator frequency (f typ=450kHz)	F01P006S05L	-	mV		40	160	RL=1k $\Omega$
	F01P015S05L				15	60	
	F01P025S05L				10	40	
	F01P050S05L				5	20	
Reaction time (@ 10% of If)	F01P006S05L	tra	$\mu s$			0.3	RL=1k $\Omega$ , di/dt=18A/ $\mu s$
	F01P015S05L					0.3	RL=1k $\Omega$ , di/dt=44A/ $\mu s$
	F01P025S05L					0.3	RL=1k $\Omega$ , di/dt=68A/ $\mu s$
	F01P050S05L					0.3	RL=1k $\Omega$ , di/dt=100/ $\mu s$
Response time (@90% of If)	F01P006S05L	tr	$\mu s$			0.3	RL=1k $\Omega$ , di/dt=18A/ $\mu s$
	F01P015S05L					0.3	RL=1k $\Omega$ , di/dt=44A/ $\mu s$
	F01P025S05L					0.3	RL=1k $\Omega$ , di/dt=68A/ $\mu s$
	F01P050S05L					0.3	RL=1k $\Omega$ , di/dt=100/ $\mu s$

# Current Sensor : F01P\*\*\*S05L

## Specification

		Symbol	Unit	Value			Comment
				min	typ	max	
Response time 2 (@ 10% of $I_f$ to 90% of $V_o$ )		$t_r$	$\mu s$			0.6	$R_L=1k\Omega$
Frequency bandwidth ( $\pm 1dB$ )		BW	kHz	200			$R_L=1k\Omega$
Frequency bandwidth ( $\pm 3dB$ )		BW	kHz	300			$R_L=1k\Omega$
Output Voltage Accuracy (Overall)	F01P006S05L	$X_G$	%			2.5	$X_G=(100 \times V_{oe}/625)+\epsilon_G+\epsilon_L$
	F01P015S05L					1.9	
	F01P025S05L					1.8	
	F01P050S05L					1.7	

## Standards

EN 50178; EN 61010-1 ; EN 60950-1 ; UL 508 (file no. E243511)

## Characteristic Curve (TYP)

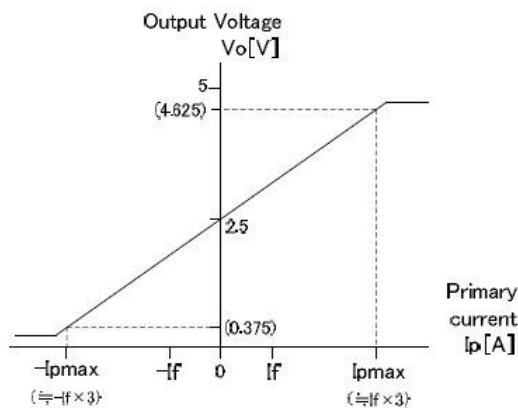

Figure 1: Linearity curve

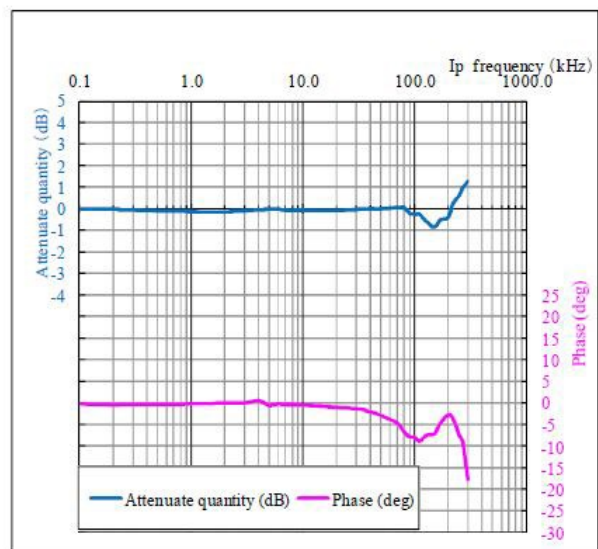

Figure 2: Frequency response curve

ex) F01P025S05L

Measurement condition  $T_a=+25^\circ C$ ,  $R_L=1k\Omega$ ,  $I_p=3A$ ,  $V_{cc}=+5V$

# Current Sensor : F01P\*\*\*S05L

## Maximum Continuous DC primary current

According to which the following conditions are true the maximum continuous DC primary current plot shows the boundary of the area.

1.  $I_p < I_{pmax}$
2. Junction temperature  $T_j < 125^\circ\text{C}$
3. Primary conductor temperature  $< 110^\circ\text{C}$
4. Resistor power dissipation  $< 0.5 \times \text{rated power}$

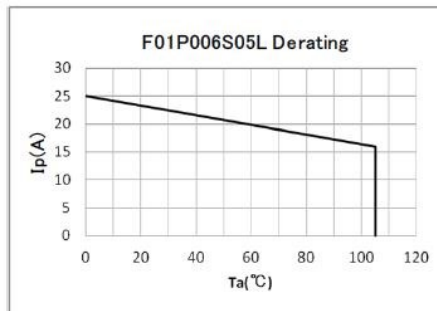

Figure 3: Ip vs Ta for F01P006S05L

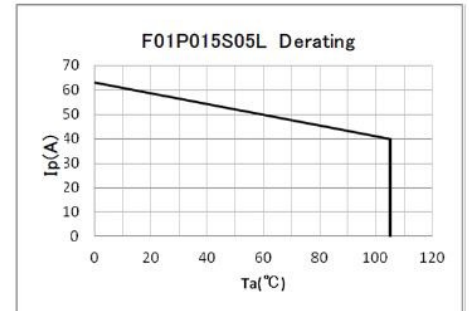

Figure 4: Ip vs Ta for F01P015S05L

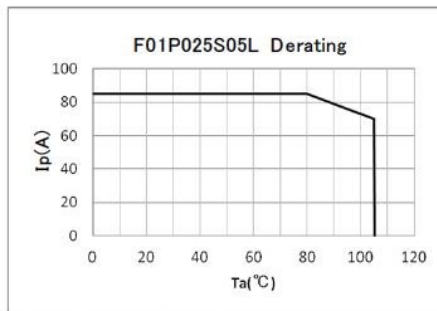

Figure 5: Ip vs Ta for F01P025S05L

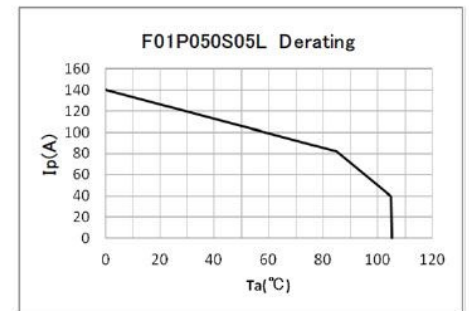

Figure 6: Ip vs Ta for F01P050S05L

## Frequency Derating

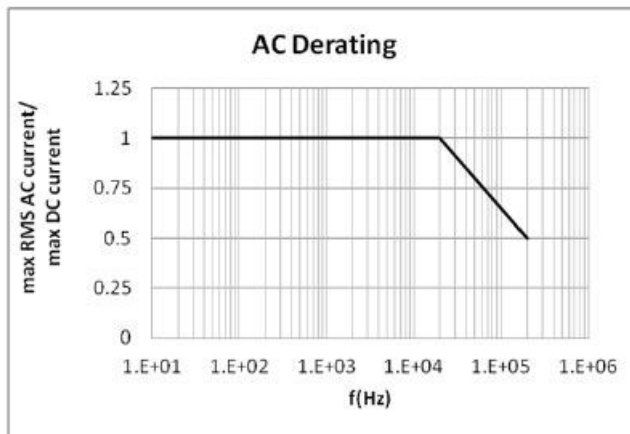
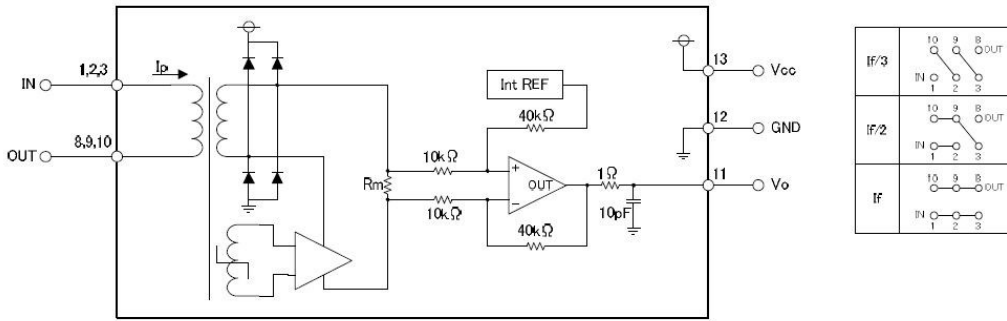

Figure 7 : Maximum RMS AC primary current / maximum DC primary current vs frequency

# Current Sensor : F01P\*\*\*S05L

## Connection



## Dimension (mm)

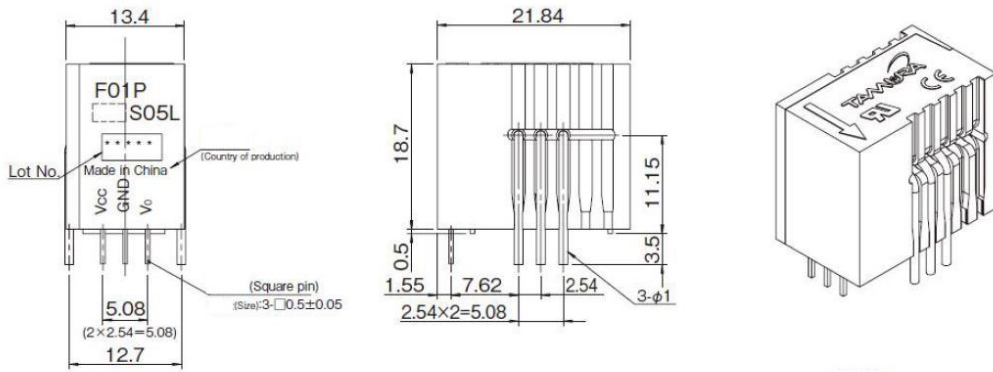

Terminal number	
① Input	⑧ Output
② Input	⑨ Output
③ Input	⑩ Output
④ -	⑪ V <sub>o</sub>
⑤ -	⑫ GND
⑥ -	⑬ V <sub>cc</sub>
⑦ -	

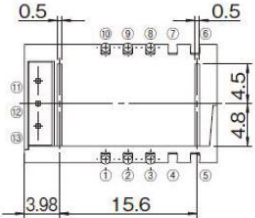

**Note**

- Unless otherwise specified, tolerances shall be  $\pm 0.25\text{mm}$
- Unit is [mm]

## Recommended Hole Diameter (mm)

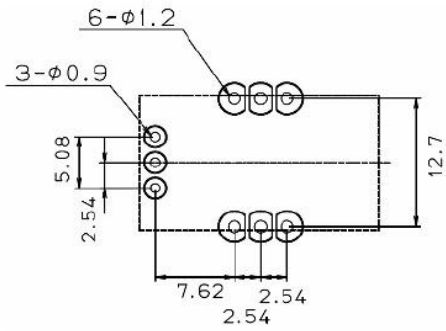



Компания «ЭлектроПласт» предлагает заключение долгосрочных отношений при поставках импортных электронных компонентов на взаимовыгодных условиях!

Наши преимущества:

- Оперативные поставки широкого спектра электронных компонентов отечественного и импортного производства напрямую от производителей и с крупнейших мировых складов;
- Поставка более 17-ти миллионов наименований электронных компонентов;
- Поставка сложных, дефицитных, либо снятых с производства позиций;
- Оперативные сроки поставки под заказ (от 5 рабочих дней);
- Экспресс доставка в любую точку России;
- Техническая поддержка проекта, помощь в подборе аналогов, поставка прототипов;
- Система менеджмента качества сертифицирована по Международному стандарту ISO 9001;
- Лицензия ФСБ на осуществление работ с использованием сведений, составляющих государственную тайну;
- Поставка специализированных компонентов (Xilinx, Altera, Analog Devices, Intersil, Interpoint, Microsemi, Aeroflex, Peregrine, Syfer, Eurofarad, Texas Instrument, Miteq, Cobham, E2V, MA-COM, Hittite, Mini-Circuits, General Dynamics и др.);

Помимо этого, одним из направлений компании «ЭлектроПласт» является направление «Источники питания». Мы предлагаем Вам помощь Конструкторского отдела:

- Подбор оптимального решения, техническое обоснование при выборе компонента;
- Подбор аналогов;
- Консультации по применению компонента;
- Поставка образцов и прототипов;
- Техническая поддержка проекта;
- Защита от снятия компонента с производства.



#### Как с нами связаться

**Телефон:** 8 (812) 309 58 32 (многоканальный)

**Факс:** 8 (812) 320-02-42

**Электронная почта:** [org@eplast1.ru](mailto:org@eplast1.ru)

**Адрес:** 198099, г. Санкт-Петербург, ул. Калинина, дом 2, корпус 4, литера А.