

THIS DRAWING IS UNPUBLISHED. RELEASED FOR PUBLICATION  
 © COPYRIGHT - By - ALL RIGHTS RESERVED.

LOC		DIST		REVISIONS			
P	LTR	DESCRIPTION	DATE	DWN	APVD		
	C1	UPDATE PER ECO-12-021131	3 DEC 12	CAS	MKS		

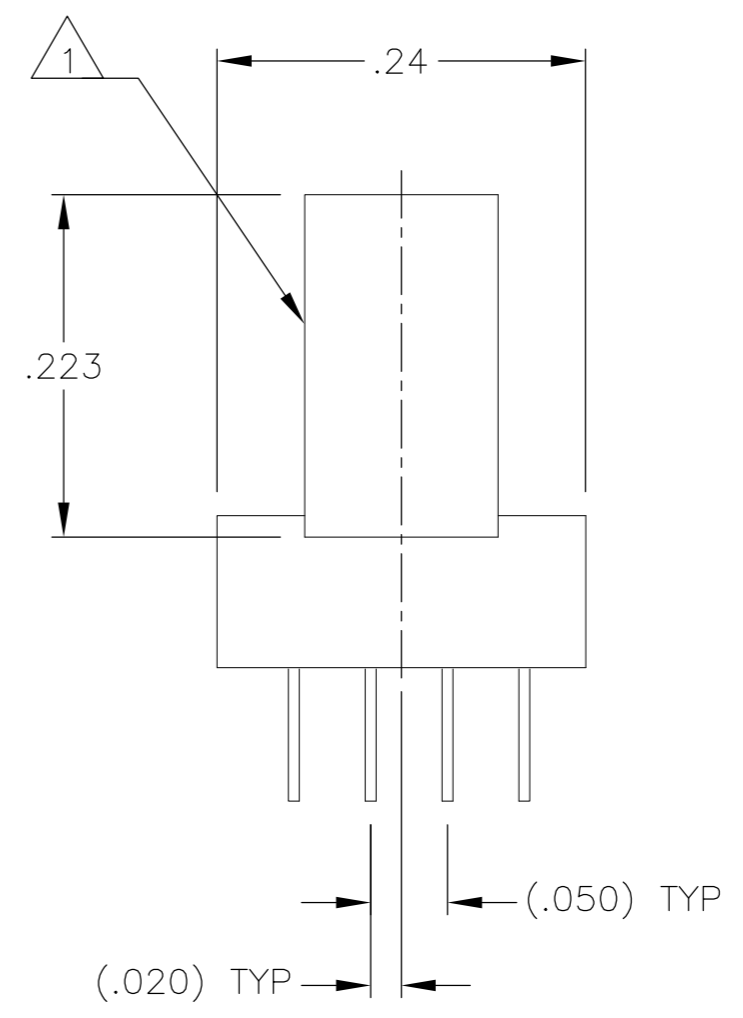
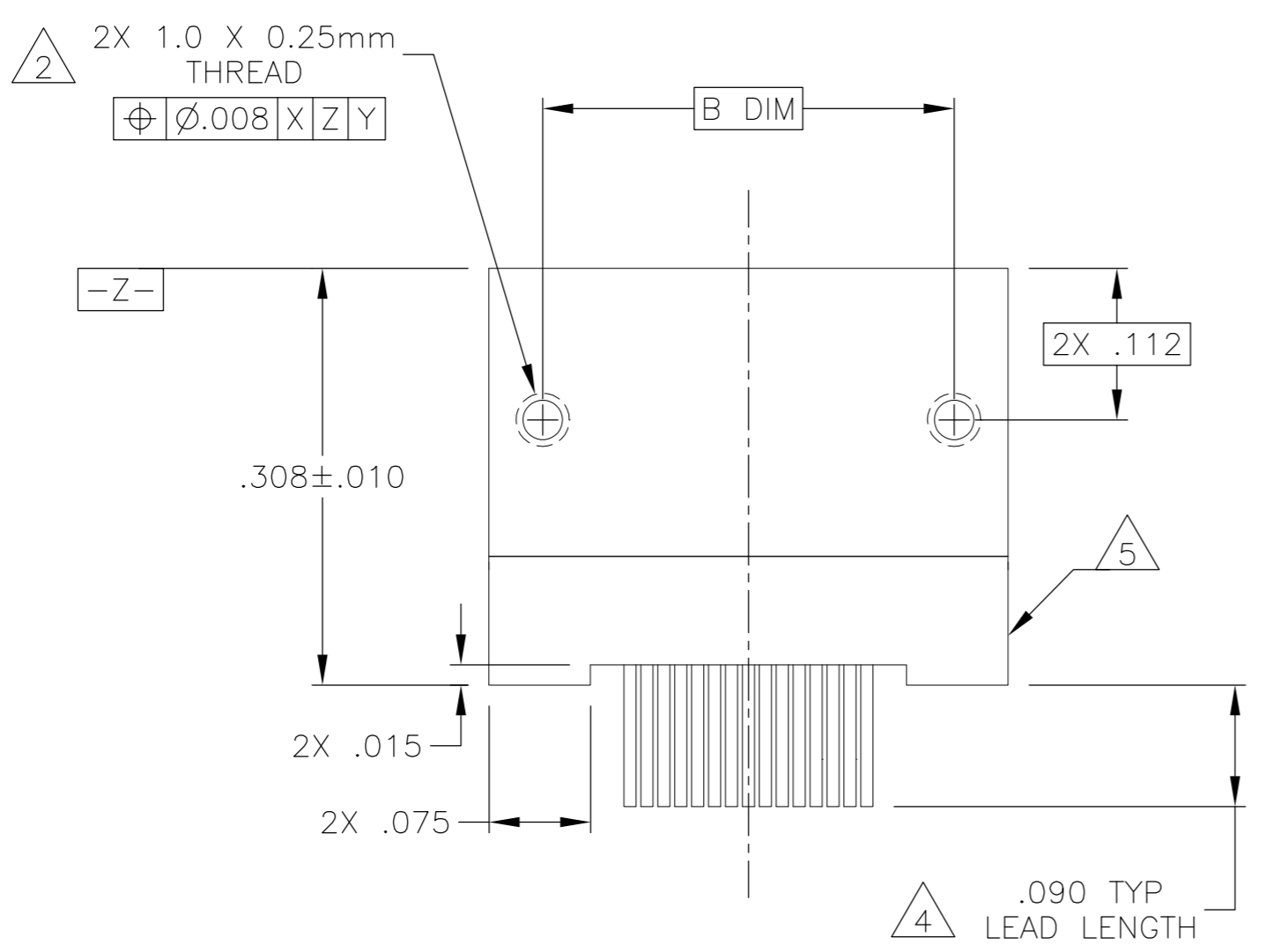
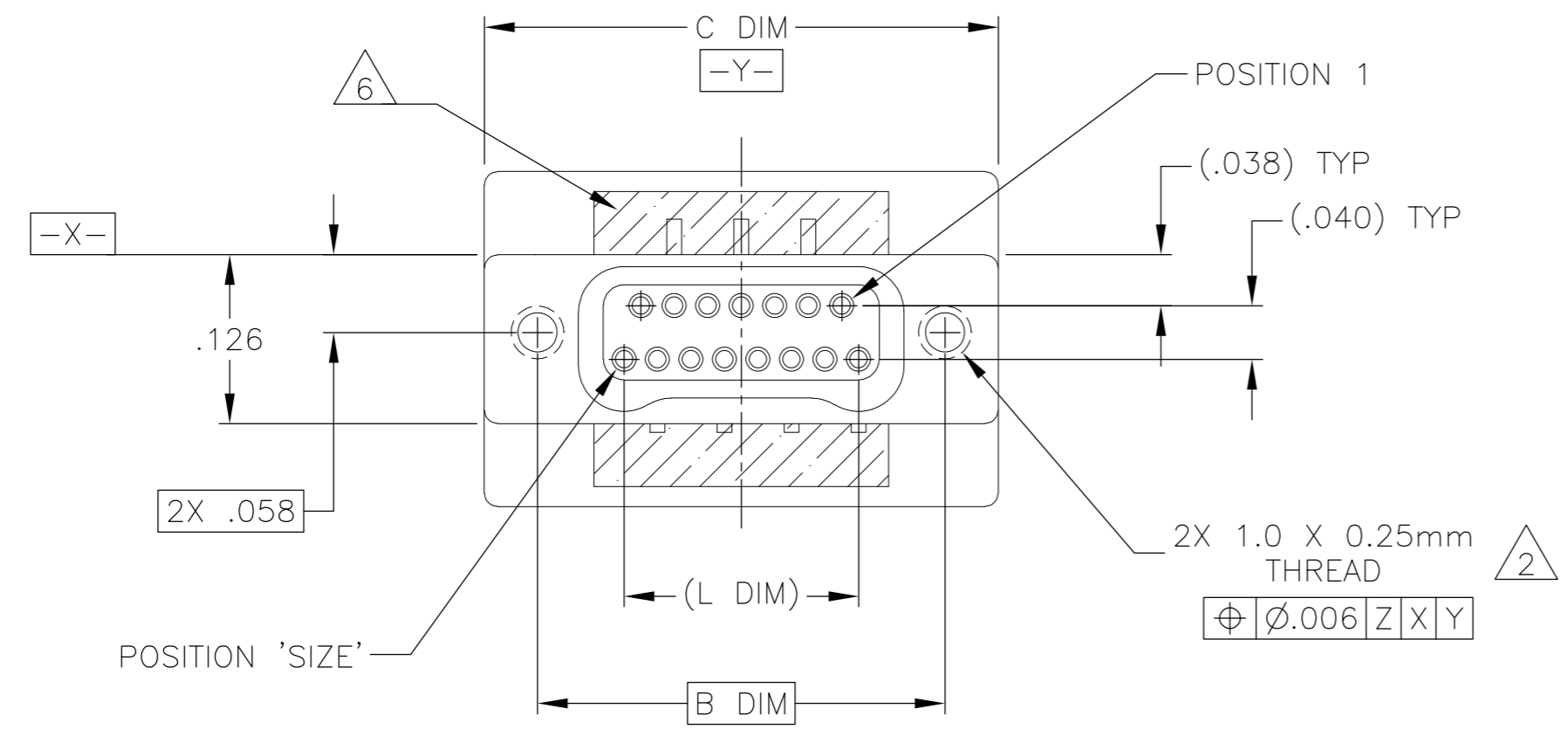

SIZE	B DIM	C DIM ±.0050	(L DIM)
09	.229	.3085	(.100)
15	.304	.3835	(.175)
25	.429	.5085	(.300)
37	.579	.6585	(.450)
51	.754	.8335	(.625)
65	.929	1.0085	(.800)

- 1. SHELL OPTIONS (TO BE SPECIFIED IN NANONICS PART NUMBER):  
 METAL: 6061-T6 ALUMINUM, ELECTROLESS NICKEL PLATED PER SAE-AMS-C-26074 OR SAE-AMS-2404 (STANDARD) OR GOLD PLATED PER ASTM B488  
 303 STAINLESS STEEL, PASSIVATED PER SAE-AMS-2700  
 INSULATOR MATERIAL FOR ALL METAL SHELLS IS LIQUID CRYSTAL POLYMER (LCP) PER MIL-M-24519 OR PER ASTM D5138  
 PLASTIC: LIQUID CRYSTAL POLYMER (LCP) PER MIL-M-24519 OR PER ASTM D5138
- 2. STANDARD 1.0 X 0.25mm MOUNTING AND JACKSCREW THREADS ARE SHOWN FOR REFERENCE ONLY AND MUST BE SPECIFIED IN THE NANONICS PART NUMBER WHEN REQUIRED. 1.2 X 0.25mm THREADS ALSO AVAILABLE.
- 3. MOUNTING HARDWARE IS AVAILABLE WITH THIS CONFIGURATION (NOT SHOWN). HARDWARE MUST BE SPECIFIED IN THE NANONICS PART NUMBER. CONSULT TYCO ELECTRONICS FOR DETAILS.
- 4. LEAD MATERIAL: HH BRASS, GOLD PLATED PER ASTM B488
- 5. LEAD ORGANIZER MATERIAL IS LIQUID CRYSTAL POLYMER PER ASTM D5138
- 6. THROUGH HOLE LEADS ARE EPOXY ENCAPSULATED WITHIN THE LEAD ORGANIZER
- 7. NANONICS TERMINATION CODE: W5
- 8. THIS DRAWING PREVIOUSLY IDENTIFIED AS NANONICS N10138/253

THIS DRAWING IS A CONTROLLED DOCUMENT.		DWN C. SCHOLL 8 AUG 03		
DIMENSIONS: INCHES		CHK M. STORRY 8 AUG 03		
TOLERANCES UNLESS OTHERWISE SPECIFIED:		APVD -	NAME	
0 PLC ± -		PRODUCT SPEC	RECEPTACLE ASSEMBLY, VERTICAL MOUNT, THROUGH HOLE, 2 TO 4 ROW, .050 SPACING, GOLD PLATED LEADS, PLASTIC OR METAL	
1 PLC ± -		APPLICATION SPEC	SIZE	CAGE CODE
2 PLC ± .010			A2	OJPN9
3 PLC ± .005			DRAWING NO	
4 PLC ± -			C=1589818	
ANGLES ± 1		WEIGHT	RESTRICTED TO	
FINISH		-	-	
MATERIAL SEE NOTES		CUSTOMER DRAWING	SCALE 8:1	SHEET 1 of 2
SEE NOTES			REV	C1

THIS DRAWING IS UNPUBLISHED. RELEASED FOR PUBLICATION  
 © COPYRIGHT - By - ALL RIGHTS RESERVED.

LOC		DIST		REVISIONS			
P	LTR	DESCRIPTION	DATE	DWN	APVD		
-	-	SEE SHEET 1	-	-	-		

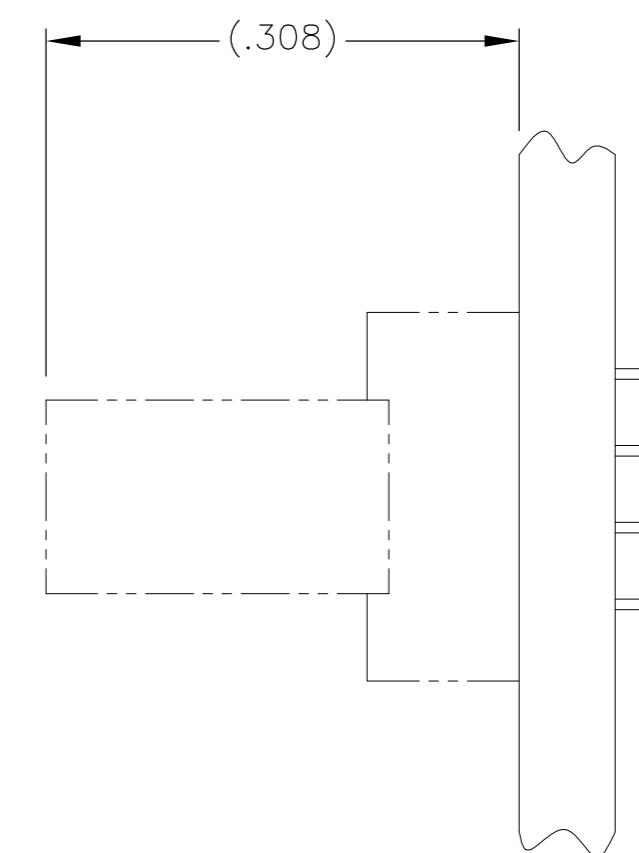
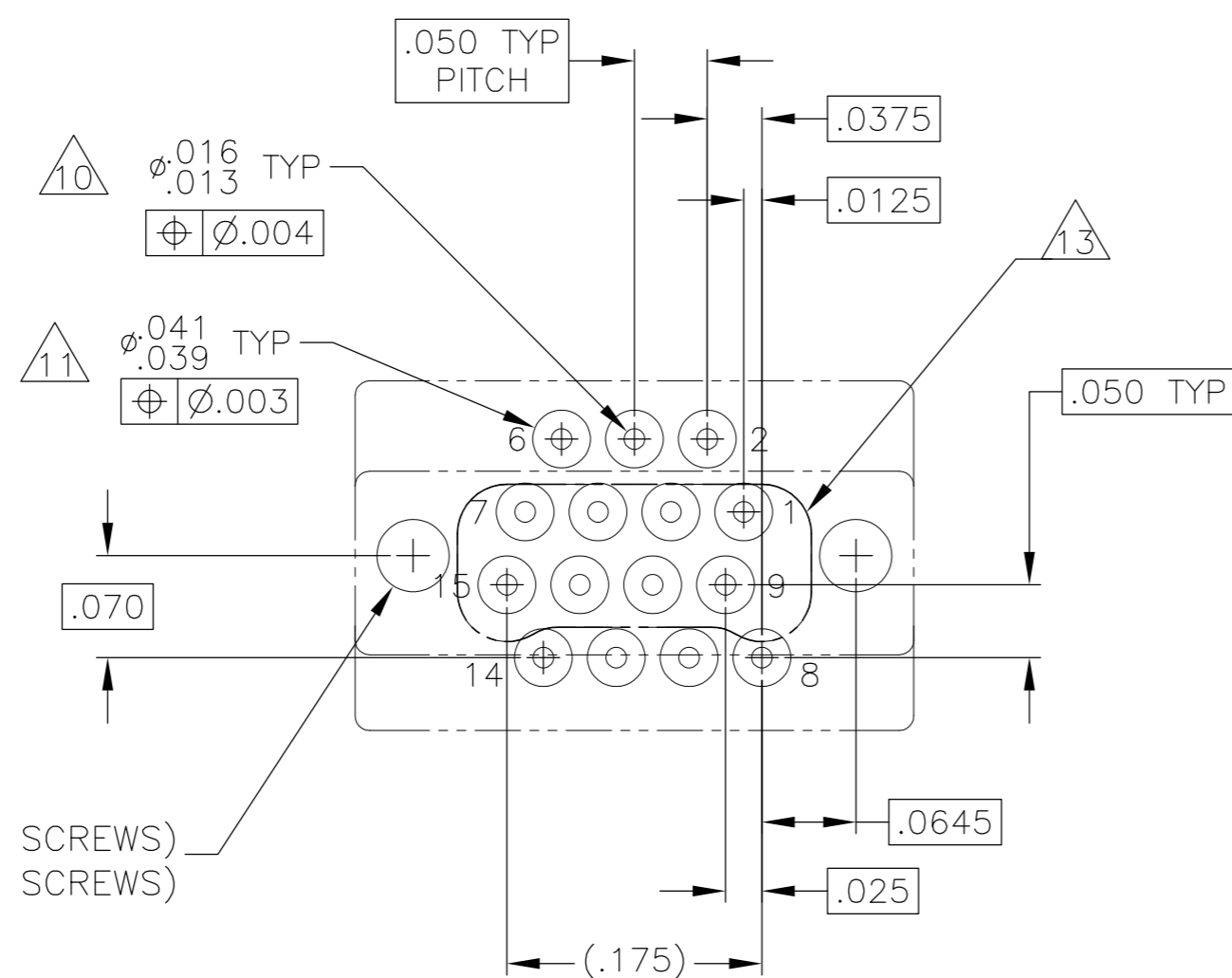
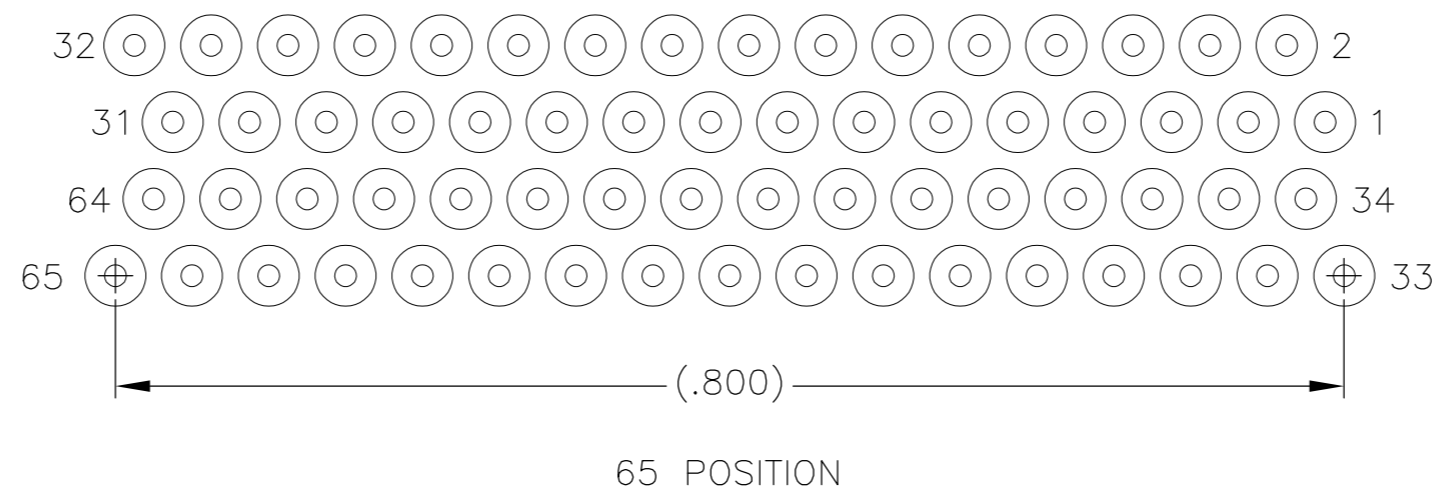
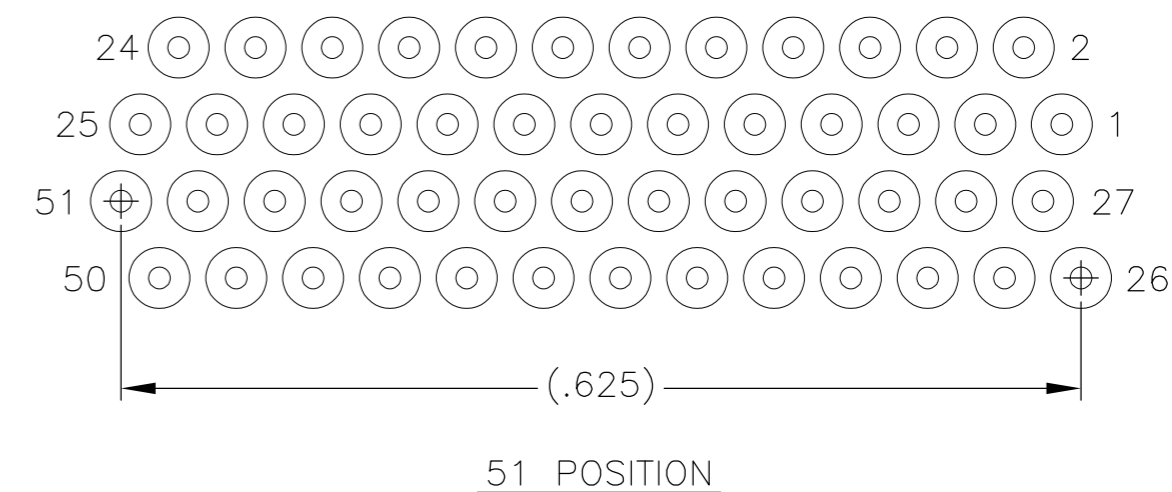
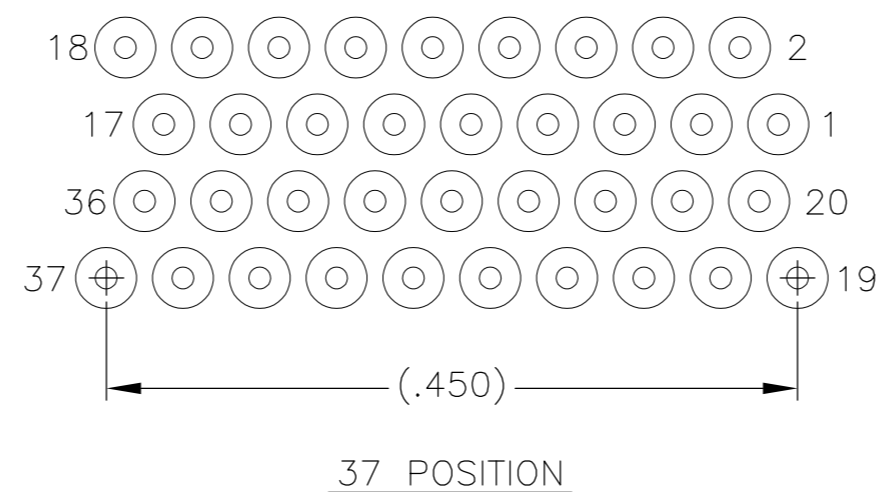
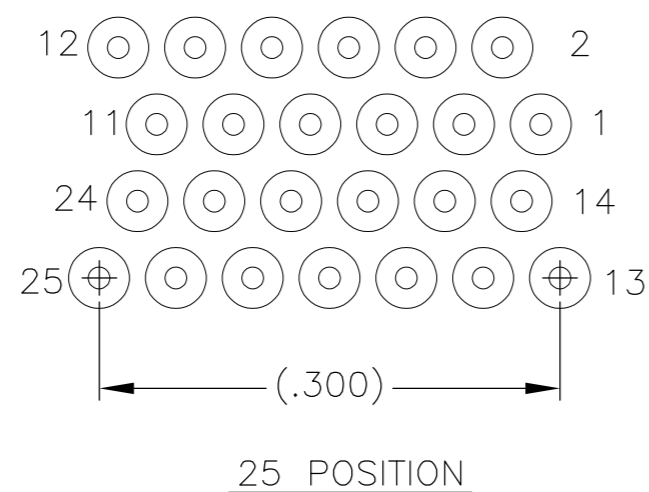
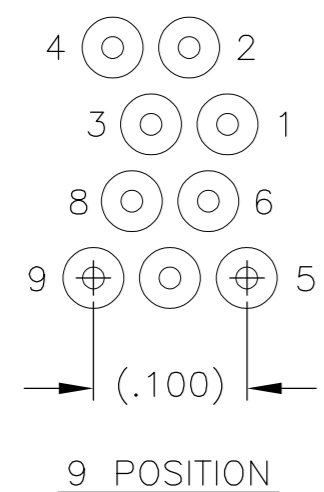

2X  $\phi .050 \pm .002$  (FOR 1.0mm MTG SCREWS)  
 $\phi .058 \pm .002$  (FOR 1.2mm MTG SCREWS)  
 $\phi \pm .004$

TYPICAL PCB LAYOUT SIZE 15 SHOWN FOR REFERENCE

- POSITIONAL TOLERANCES FOR BASIC DIMENSIONED FEATURES ARE RELATIVE TO FIDUCIALS OR SOME SIMILAR DATUM REFERENCES DEFINED BY PCB DESIGNER.
- PLATED THROUGH HOLES
- SOLDER PADS
- 12. ALL THROUGH HOLE LAYOUTS ARE AS VIEWED FROM TOP OF PCB.
- CONNECTOR ORIENTATION

THIS DRAWING IS A CONTROLLED DOCUMENT.		DWN C. SCHOLL 8 AUG 03	TE Connectivity RECEPTACLE ASSEMBLY, VERTICAL MOUNT, THROUGH HOLE, 2 TO 4 ROW, .050 SPACING, GOLD PLATED LEADS, PLASTIC OR METAL	
DIMENSIONS: INCHES		CHK M. STORRY 8 AUG 03		
TOLERANCES UNLESS OTHERWISE SPECIFIED:		APVD -	NAME	
 0 PLC ± - 1 PLC ± - 2 PLC ± .010 3 PLC ± .005 4 PLC ± - ANGLES ± 1		PRODUCT SPEC -	SIZE	
MATERIAL SEE NOTES		APPLICATION SPEC -	CAGE CODE A2	DRAWING NO OJPN9
FINISH SEE NOTES		WEIGHT -	DRAWING NO C=1589818	
		CUSTOMER DRAWING	SCALE 8:1	SHEET 2 of 2
			RESTRICTED TO -	REV C1



Компания «ЭлектроПласт» предлагает заключение долгосрочных отношений при поставках импортных электронных компонентов на взаимовыгодных условиях!

Наши преимущества:

- Оперативные поставки широкого спектра электронных компонентов отечественного и импортного производства напрямую от производителей и с крупнейших мировых складов;
- Поставка более 17-ти миллионов наименований электронных компонентов;
- Поставка сложных, дефицитных, либо снятых с производства позиций;
- Оперативные сроки поставки под заказ (от 5 рабочих дней);
- Экспресс доставка в любую точку России;
- Техническая поддержка проекта, помощь в подборе аналогов, поставка прототипов;
- Система менеджмента качества сертифицирована по Международному стандарту ISO 9001;
- Лицензия ФСБ на осуществление работ с использованием сведений, составляющих государственную тайну;
- Поставка специализированных компонентов (Xilinx, Altera, Analog Devices, Intersil, Interpoint, Microsemi, Aeroflex, Peregrine, Syfer, Eurofarad, Texas Instrument, Miteq, Cobham, E2V, MA-COM, Hittite, Mini-Circuits, General Dynamics и др.);

Помимо этого, одним из направлений компании «ЭлектроПласт» является направление «Источники питания». Мы предлагаем Вам помощь Конструкторского отдела:

- Подбор оптимального решения, техническое обоснование при выборе компонента;
- Подбор аналогов;
- Консультации по применению компонента;
- Поставка образцов и прототипов;
- Техническая поддержка проекта;
- Защита от снятия компонента с производства.



#### Как с нами связаться

**Телефон:** 8 (812) 309 58 32 (многоканальный)

**Факс:** 8 (812) 320-02-42

**Электронная почта:** [org@eplast1.ru](mailto:org@eplast1.ru)

**Адрес:** 198099, г. Санкт-Петербург, ул. Калинина, дом 2, корпус 4, литера А.