

**Accessories Industrial Power Relay RT**

- For Industrial Power Relay RT  
pinnings 3.5 mm / 5 mm; relay height 15.7 mm
- New retainer clip with ejection function
- Easy replacement of relays on a densely packed DIN rail
- No reduction of protection class or creepage/clearance with plastic retainer
- Simple plug-in indicator- and protection modules
- White snap-on marking tags

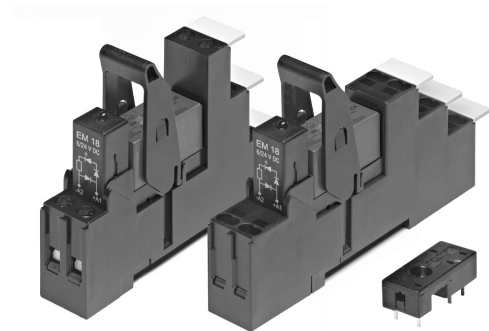

F0228-G

**Premium socket with screwless terminals for DIN rail mounting**

RT 78 72P Premium socket, logical terminal arrangement

- Screwless Clamps
- Mounting of solid wires without tool
- Double Clamps per terminal
- Jumper links for interconnection
- Open coil circuit for active modules
- Logical terminal arrangement

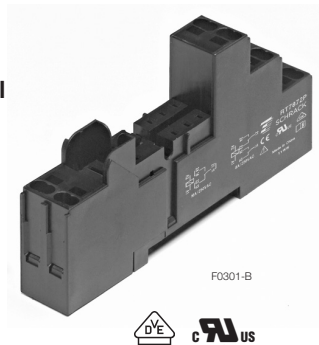

F0301-B

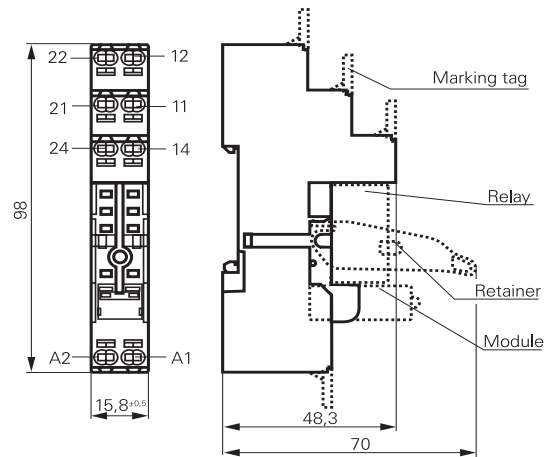

S0545-CA

**Approvals**

VDE Cert. No. 40007571, cULus E135149

**Technical data**

Rated voltage/Max. switching voltage AC	240/400 VAC
Rated current	2 x 8 A, 16 A*)
Dielectric strength	coil-contact circuit 5000 V <sub>rms</sub>
	open contact circuit 1000 V <sub>rms</sub>
	adjacent contact circuits 2500 V <sub>rms</sub>
Clearance / creepage	coil-contact circuit ≥ 10/10 mm
	Material group of insulation parts IIIa
Flammability class UL 94	V-0
Insulation to IEC 60664-1	Type of insulation coil-contact circuit reinforced
	open contact circuit functional
	adjacent contact circuits functional
	Rated insulation voltage 250 V
Pollution degree	2
Rated voltage system	230 / 400 V
Overtoltage category	III

\*) For 1 pole relays (16 A) the relay terminals 11-21, 12-22 and 14-24 have to be bridged.

- Not suitable for bistable relays with 2 coils!

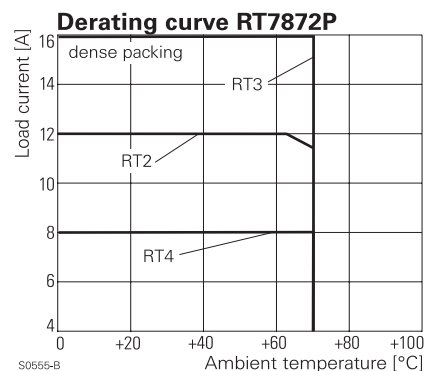

S0555-B

**Accessories Industrial Power Relay RT (Continued)**

**Technical data (continued)**

Material compliance: EU RoHS/ELV, China RoHS, REACH, Halogen content refer to the Product Compliance Support Center at [www.te.com/customersupport/rohssupportcenter](http://www.te.com/customersupport/rohssupportcenter)

Ambient temperature range	
for mounting/handling	-20...+70°C
in operation	-40...+70°C
Terminals	screwless
Wire strip length	12 mm
Wire cross section	
solid wire	1x0.75/1/1.5mm <sup>2</sup> 2x0.75/1mm <sup>2</sup> 2x1.5mm <sup>2</sup>
with stand. isolation (no oversize isolation)	2x1.5mm <sup>2</sup>
stranded wire	
without bootlace crimp	1x0.75/1/1.5mm <sup>2</sup> 2x0.75/1mm <sup>2</sup> 2x1.5mm <sup>2</sup>
without bootlace crimp with stand. isolation	2x1.5mm <sup>2</sup>
with bootlace crimp	1x0.75/1mm <sup>2</sup> 2x0.75mm <sup>2</sup> 1x1.5mm <sup>2</sup>
with bootlace crimp without isolation	1x1.5mm <sup>2</sup>
or min 18 mm long	

For stranded wires with braids 0.05 mm or smaller the use of bootlace crimps is recommended. When using stranded wires without bootlace crimp, the clamp must be opened during insertion.

Insertion cycles	A (10)
Max. Insertion Force total	100 N
Mounting distance	≥ 0, dense packing
Weight	36 g
Packaging unit	10 pcs

**Socket with screwless terminals for DIN rail mounting**

Type	Part Number
<b>RT 78 72P</b> Premium socket, logical terminal arrangement Socket with screwless terminals, pinning 5 mm for DIN rail mounting	1860200-1

**Accessories for RT 78 72P**

Type	Part Number
<b>RT 17 017</b> Plastic retaining clip, relay height 15.7 mm	2022103-1
<b>RT 17 040</b> Marking tag	2-1415038-1
<b>RT 17 0P1</b> Jumper link, max load 12 A	1860211-1

**How to use, Precautions**

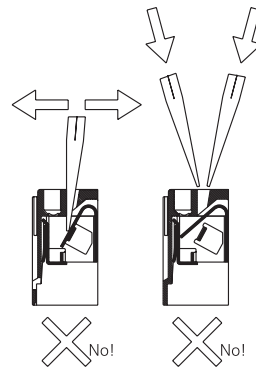
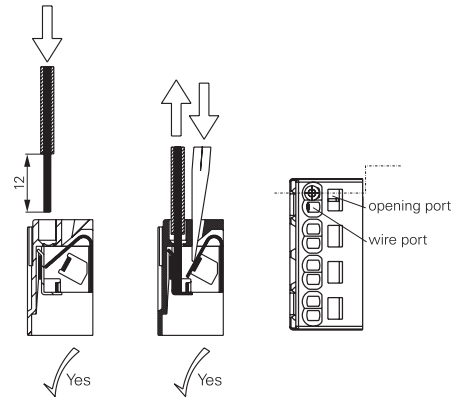
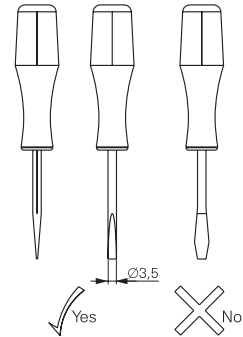

Jumper link

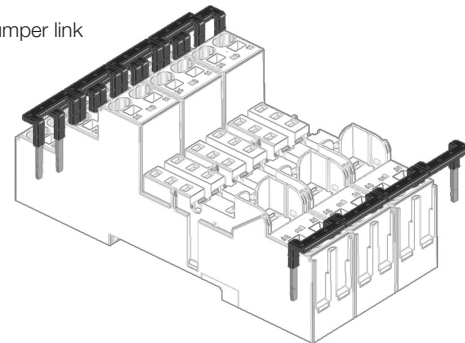

**Accessories Industrial Power Relay RT (Continued)**

**Socket with screw-type terminals for DIN rail mounting**

**RT 78 724** Socket with screw-type terminals, pinning 3.5 mm for DIN rail mounting

**RT 78 726** Socket with screw-type terminals, pinning 5 mm for DIN rail mounting, logical terminal arrangement

- DIN-rail socket with logical setup of connections (input/output)
- High quality rising clamp terminals
- Captive combination terminal screws
- Jumper bars for interconnection

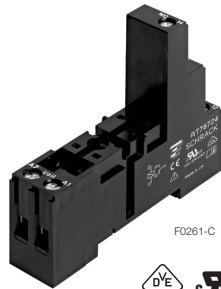

**RT 78 724**

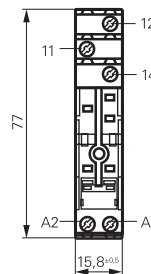

S0416-CA

**RT 78 726**

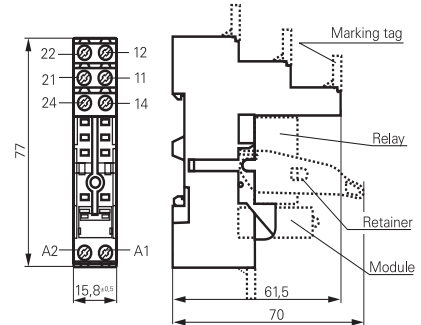

S0416-CB

**RT 78 725** Socket with screw-type terminals, pinning 5 mm for DIN rail mounting, conventional terminal arrangement

- Conventional terminal arrangement

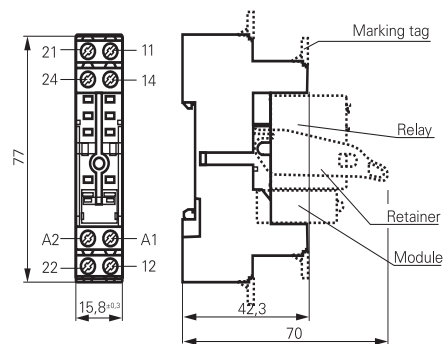
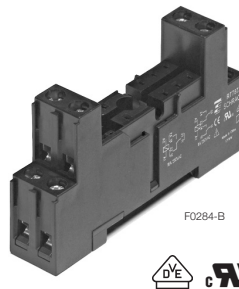

S0540-BT

**Approvals**

VDE Cert. No. 40007571, cULus E135149

**Technical data** **RT78724/RT78726** **RT78725**

Rated voltage/Max. switching voltage AC	240/400 VAC		
Rated current	12 A, 2 x 8 A, 16 A*)		
Dielectric strength	coil-contact circuit	5000 V <sub>rms</sub> 4000 V <sub>rms</sub>	
	open contact circuit	1000 V <sub>rms</sub> 1000 V <sub>rms</sub>	
	adjacent contact circuits	2500 V <sub>rms</sub> 2500 V <sub>rms</sub>	
Clearance / creepage	coil-contact circuit	≥ 10/10 mm ≥ 4.7/4.7 mm	
	Material group of insulation parts	IIIa	
Flammability class UL 94	V-0		
Insulation to IEC 60664-1	Type of insulation	coil-contact circuit	reinforced basic
		open contact circuit	functional
		adjacent contact circuits	functional
	Rated insulation voltage	250 V	
Pollution degree	2		
Rated voltage system	230 / 400 V		
Overvoltage category	III		

Material compliance: EU RoHS/ELV, China RoHS, REACH, Halogen content refer to the Product Compliance Support Center at [www.te.com/customer-support/rohssupportcenter](http://www.te.com/customer-support/rohssupportcenter)

\*) For 1 pole relays (16 A) the relay terminals 11-21, 12-22 and 14-24 have to be bridged.  
For 1 pole relays (12 A) the relay terminals 11-12-14 have to be connected to the socket terminals 21-12-14.

- Not suitable for bistable relays with 2 coils!

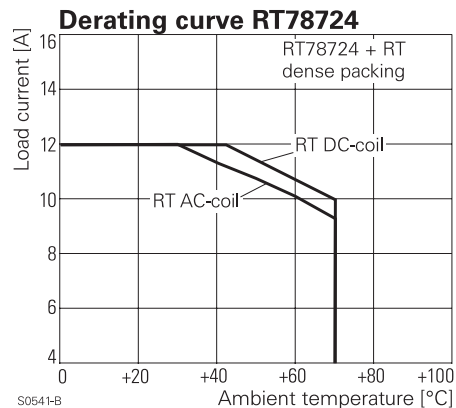

**Accessories Industrial Power Relay RT (Continued)**

**Technical data (continued) RT78724/RT78726 RT78725**

Ambient temperature range for mounting/handling	-20...+70°C
in operation	-40...+70°C
Terminals	screw
Terminals screw torque acc. IEC 61984	0.5 Nm
max.	0.7 Nm
Terminal Screw size	M3
Wire strip length	8 mm
Wire cross section	
single wire	2 x 2.5 mm <sup>2</sup>
fine wire	2 x 2.5 mm <sup>2</sup>
with bootlace crimp (DIN 46228/1)	2 x 1.5 mm <sup>2</sup>
Insertion cycles	A (10)
Max. Insertion Force total	100 N
Mounting distance	≥ 0, dense packing
Weight	36 g
Packaging unit	10 pcs

**Socket with screw-type terminals for DIN rail mounting**

Type		Part Number
<b>RT 78 724</b>	Socket with screw-type terminals, pinning 3.5 mm for DIN rail mounting, logical terminal arrangement	8-1415035-1
<b>RT 78 726</b>	Socket with screw-type terminals, pinning 5 mm for DIN rail mounting, logical terminal arrangement	6-1415035-1
<b>RT 78 725</b>	Socket with screw-type terminals, pinning 5 mm for DIN rail mounting, conventional terminal arrangement	1860306-1

**Accessories for RT 78 724, RT 78 725, RT 78 726**

Type		Part Number
<b>RT 17 017</b>	Plastic retaining clip, relay height 15.7 mm	2022103-1
<b>RT 28 816</b>	Metal retaining clip, relay height 15.7 mm	1415540-8
<b>RT 17 040</b>	Marking tag	2-1415038-1
<b>RT 17 0R8</b>	Jumper bar, max load 12 A for connection of up to 8 RT sockets	1860517-8

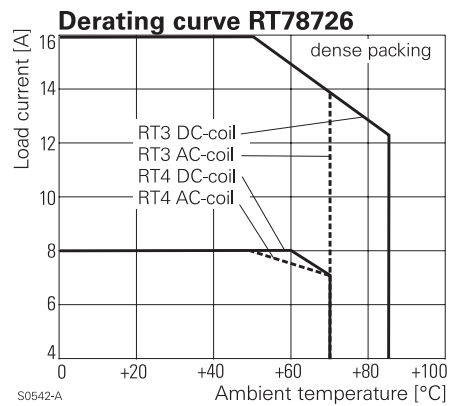
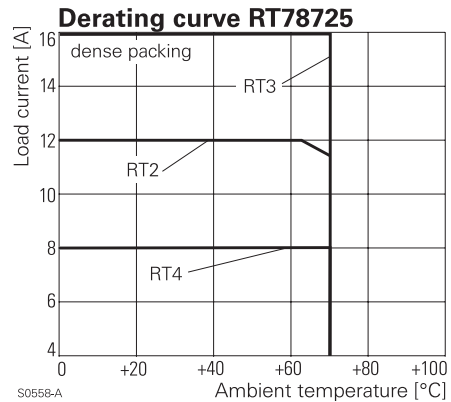

**Marking tags**

- White marking area 15.5 x 6 mm
- Snaps on socket in up to 4 positions

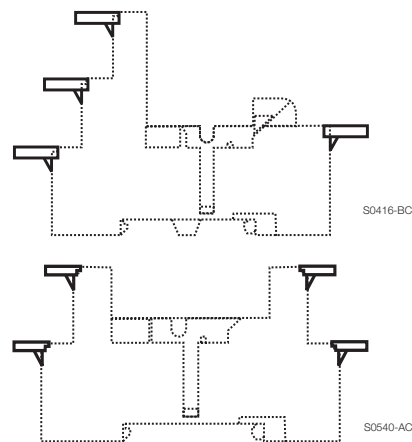
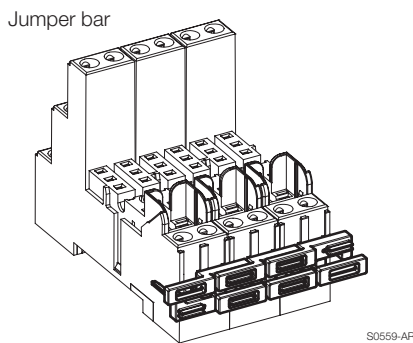

**Accessories Industrial Power Relay RT** (Continued)

**LED- and Protection Modules for RT 78 72P, RT 78 724, RT 78 725, RT 78 726**

Easy insertion of module into the socket  
Wiring in parallel to the coil

Type			Part Number
<b>PTM TO 0A0</b>	EM09	Protection diode (standard, A1+,A2-)	9-1415036-1
<b>PTM TO 0L0</b>	EM01	Protection diode (A1-, A2+)	1415037-1
<b>PTM UO 524</b>	EM02	RC-network 6...60 VAC	1-1415037-1
<b>PTM UO 730</b>	EM03	RC-network 110...230 VAC	2-1415037-1
<b>PTM VO 524</b>	EM04	Varistor 24 VAC	3-1415037-1
<b>PTM VO 615</b>	EM13	Varistor 115 VAC	6-1415365-1
<b>PTM VO 730</b>	EM05	Varistor 230 VAC	4-1415037-1
<b>PTM DO 730</b>	EM31	Residual current bypass RC 110...230 VAC	1415037-2
<b>PTM RO 730</b>	EM29	Residual current bypass resistor 110...230 VAC	1-1415539-2

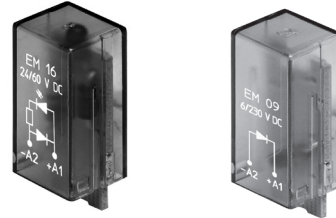

**LED**

<b>PTM LO 024</b>	EM18	red LED 6...24 VDC w. prot. diode (std, A1+, A2-)	5-1415036-1
<b>PTM GO 024</b>	EM12	green LED 6...24 VDC w. prot. diode (std, A1+, A2-)	2-1415036-1
<b>PTM L1 024</b>	EM08	red LED 6...24 VDC w. prot. diode (A1-, A2+)	8-1415036-1
<b>PTM LO 060</b>	EM16	red LED 24...60 VDC w. prot. diode (std, A1+, A2-)	5-1415539-3
<b>PTM GO 060</b>	EM25	green LED 24...60 VDC w. prot. diode (std, A1+, A2-)	7-1415539-7
<b>PTM LO 110</b>	EM19	red LED 60...110 VDC w. prot. diode (A1+, A2-)	2-1415392-1
<b>PTM GO 110</b>	EM26	green LED 60...110 VDC w. prot. diode (A1+, A2-)	1-1415539-7
<b>PTM LO 220</b>	EM27	red LED 110...220 VDC w. prot. diode (A1+, A2-)	1-1415539-4
<b>PTM GO 220</b>	EM28	green LED 110...220 VDC w. prot. diode (A1+, A2-)	1-1415539-6
<b>PTM LO 524</b>	EM07	red LED 6...24 VDC/VAC	6-1415036-1
<b>PTM GO 524</b>	EM11	green LED 6...24 VDC/VAC	3-1415036-1
<b>PTM LO 560</b>	EM14	red LED 24...60 VDC/VAC	1-1415539-3
<b>PTM GO 560</b>	EM30	green LED 24...60 VDC/VAC	1-1415539-5
<b>PTM LO 730</b>	EM06	red LED 110...230 VAC	7-1415036-1
<b>PTM GO 730</b>	EM10	green LED 110...230 VAC	4-1415036-1

**Relay Packages**

Complete packages consisting of a relay mounted on a socket: see Relay Package RT

**Accessories Industrial Power Relay RT (Continued)**

**Sockets for PCB mount**

**RP 78 601**, Socket with PCB terminals, pinning 3.5 mm

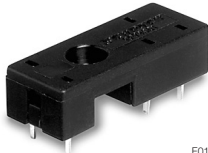

F0116-A

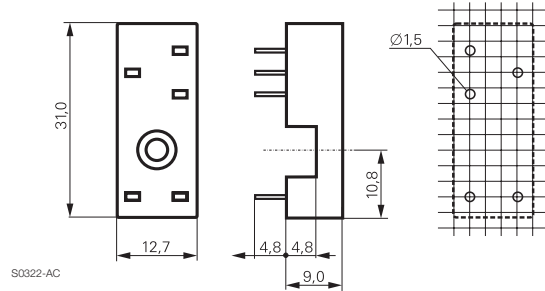

S0322-AC

**RP 78 602**, Socket with PCB terminals, pinning 5 mm

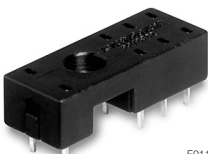

F0117-A

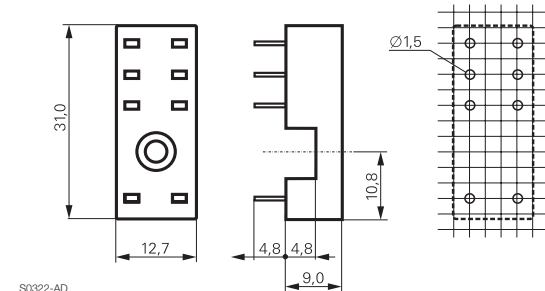

S0322-AD

**Approvals**

cULus E135149

**Technical data RP 78 601/RP 78 602**

Rated voltage/max. switching voltage AC	240/400 VAC
Rated current	12 A*)
Limiting continuous current	see derating curve
Dielectric strength	
coil-contact circuit	4000 V <sub>rms</sub>
open contact circuit	1000 V <sub>rms</sub>
adjacent contact circuits	2500 V <sub>rms</sub>
Clearance / creepage	
coil-contact circuit	≥ 10/10 mm
Material group of insulation parts	
Insulation to IEC 60664-1	
Type of insulation	
coil-contact circuit	reinforced
open contact circuit	functional
adjacent contact circuits	functional
Rated insulation voltage	250 V
Pollution degree	2
Rated voltage system	230 / 400 V
Overvoltage category	III

Material compliance: EU RoHS/ELV, China RoHS, REACH, Halogen content refer to the Product Compliance Support Center at [www.te.com/customersupport/rohssupportcenter](http://www.te.com/customersupport/rohssupportcenter)

Ambient temperature range	-40...+80°C
Terminals	pcb
Insertion cycles	A (10)
Max. Insertion Force total	100 N
Mounting distance	≥ 0, dense packing
Resistance to soldering heat	270°C / 10 s
Weight	3 g
Packaging unit	100 pcs

\*) For 1 pole relays (16 A) the relay terminals 11-21, 12-22 and 14-24 have to be bridged on the PCB.

**Derating curve RP78601**

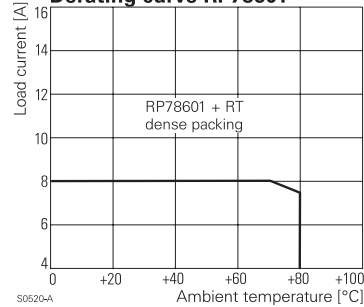

S0520-A

**Derating curve RP78602**

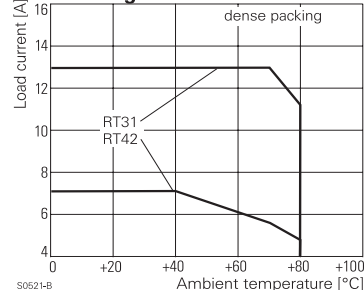

S0521-B

**Sockets with PCB terminals**

Type		Part Number
<b>RP 78 601</b>	Socket with PCB terminals, pinning 3.5 mm	8-1393234-4
<b>RP 78 602</b>	Socket with PCB terminals, pinning 5 mm	8-1393234-5

**Accessories for RP 78 601, RP 78 602**

Type		Part Number
<b>RT 16 041</b>	Plastic retaining clip RT, relay height 15.7 mm	3-1393161-4
<b>RT 28 516</b>	Metal retaining clip RT, relay height 15.7 mm	1419108-7



Компания «ЭлектроПласт» предлагает заключение долгосрочных отношений при поставках импортных электронных компонентов на взаимовыгодных условиях!

Наши преимущества:

- Оперативные поставки широкого спектра электронных компонентов отечественного и импортного производства напрямую от производителей и с крупнейших мировых складов;
- Поставка более 17-ти миллионов наименований электронных компонентов;
- Поставка сложных, дефицитных, либо снятых с производства позиций;
- Оперативные сроки поставки под заказ (от 5 рабочих дней);
- Экспресс доставка в любую точку России;
- Техническая поддержка проекта, помощь в подборе аналогов, поставка прототипов;
- Система менеджмента качества сертифицирована по Международному стандарту ISO 9001;
- Лицензия ФСБ на осуществление работ с использованием сведений, составляющих государственную тайну;
- Поставка специализированных компонентов (Xilinx, Altera, Analog Devices, Intersil, Interpoint, Microsemi, Aeroflex, Peregrine, Syfer, Eurofarad, Texas Instrument, Miteq, Cobham, E2V, MA-COM, Hittite, Mini-Circuits, General Dynamics и др.);

Помимо этого, одним из направлений компании «ЭлектроПласт» является направление «Источники питания». Мы предлагаем Вам помощь Конструкторского отдела:

- Подбор оптимального решения, техническое обоснование при выборе компонента;
- Подбор аналогов;
- Консультации по применению компонента;
- Поставка образцов и прототипов;
- Техническая поддержка проекта;
- Защита от снятия компонента с производства.



#### Как с нами связаться

**Телефон:** 8 (812) 309 58 32 (многоканальный)

**Факс:** 8 (812) 320-02-42

**Электронная почта:** [org@eplast1.ru](mailto:org@eplast1.ru)

**Адрес:** 198099, г. Санкт-Петербург, ул. Калинина, дом 2, корпус 4, литера А.