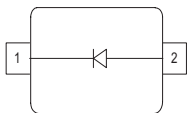
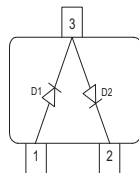
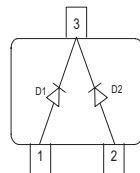
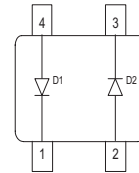
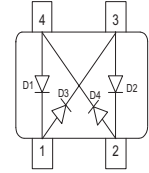

Silicon Schottky Diodes

- Low barrier type for DBS mixer applications up to 12 GHz, phase detectors and modulators
- Low noise figure
- Pb-free (RoHS compliant) package

BAT15-02LRH
BAT15-03W

BAT15-04W

BAT15-05W

BAT15-099
BAT15-099LRH

BAT15-099R

ESD (Electrostatic discharge) sensitive device, observe handling precaution!

Type	Package	Configuration	L_S (nH)	Marking
BAT15-02LRH	TSLP-2-7	single, leadless	0.4	NP
BAT15-03W	SOD323	single	1.8	white P
BAT15-04W	SOT323	series	1.4	S8s
BAT15-05W	SOT323	common cathode	1.4	S5s
BAT15-07LRH	TSLP-4-7	parallel pair, leadless	0.4	NP
BAT15-098LRH	TSLP-4-7	anti-parallel pair, leadless	0.4	B
BAT15-099	SOT143	anti-parallel pair	2	S5s
BAT15-099R	SOT143	cross-over ring	2	S6s
BAT15-099LRH	TSLP-4-7	anti-parallel pair, leadless	0.4	S5

Maximum Ratings at $T_A = 25^\circ\text{C}$, unless otherwise specified

Parameter	Symbol	Value	Unit
Diode reverse voltage	V_R	4	V
Forward current	I_F	110	mA
Total power dissipation	P_{tot}		mW
BAT15-02LRH, -099LRH $T_S \leq 76^\circ\text{C}$		100	
BAT15-03W, $T_S \leq 70^\circ\text{C}$		100	
BAT15-04W, $T_S \leq 68^\circ\text{C}$		100	
BAT15-05W, $T_S \leq 65^\circ\text{C}$		100	
BAT15-099, $T_S \leq 48^\circ\text{C}$		100	
BAT15-099R, $T_S \leq 67^\circ\text{C}$		100	
Junction temperature	T_j	150	°C
Operating temperature range	T_{op}	-55 ... 150	
Storage temperature	T_{stg}	-55 ... 150	

Thermal Resistance

Parameter	Symbol	Value	Unit
Junction - soldering point ¹⁾	R_{thJS}		K/W
BAT15-02LRH, -099LRH		≤ 780	
BAT15-03W		≤ 795	
BAT15-04W		≤ 820	
BAT15-05W		≤ 850	
BAT15-099		≤ 1020	
BAT15-099R		≤ 830	

¹⁾For calculation of R_{thJA} please refer to Application Note Thermal Resistance

Electrical Characteristics at $T_A = 25^\circ\text{C}$, unless otherwise specified

Parameter	Symbol	Values			Unit
		min.	typ.	max.	
DC Characteristics					
Breakdown voltage $I_{(BR)} = 100 \mu\text{A}$	$V_{(BR)}$	4	-	-	V
Forward voltage $I_F = 1 \text{ mA}$ $I_F = 10 \text{ mA}$	V_F	0.16 0.25	0.23 0.32	0.32 0.41	
Forward voltage matching ¹⁾ $I_F = 10 \text{ mA}$	ΔV_F	-	-	20	mV
AC Characteristics					
Diode capacitance $V_R = 0 \text{ V}$, $f = 1 \text{ MHz}$, all other types $V_R = 0 \text{ V}$, $f = 1 \text{ MHz}$, BAT15-099R	C_T	- -	- -	0.35 0.5	pF
Differential forward resistance $I_F = 10 \text{ mA} / 50 \text{ mA}$	R_F	-	5.5	-	Ω

¹⁾ ΔV_F is the difference between lowest and highest V_F in a multiple diode component.

Diode capacitance $C_T = f(V_R)$

$f = 1\text{MHz}$

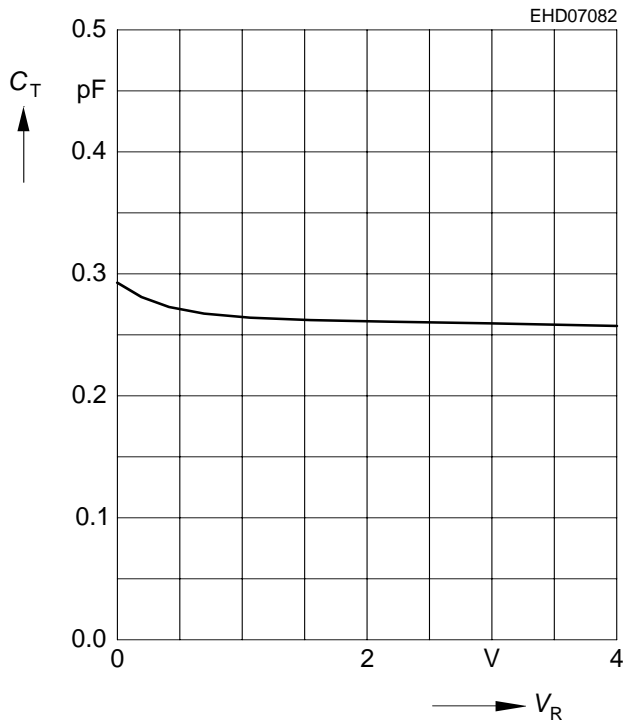

Reverse current $I_R = f(V_R)$

$T_A = \text{Parameter}$

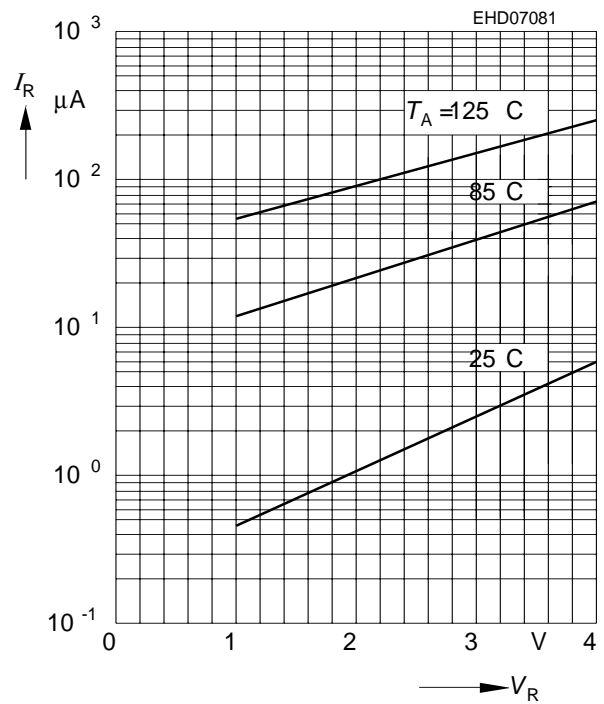

Forward current $I_F = f(V_F)$

$T_A = \text{Parameter}$

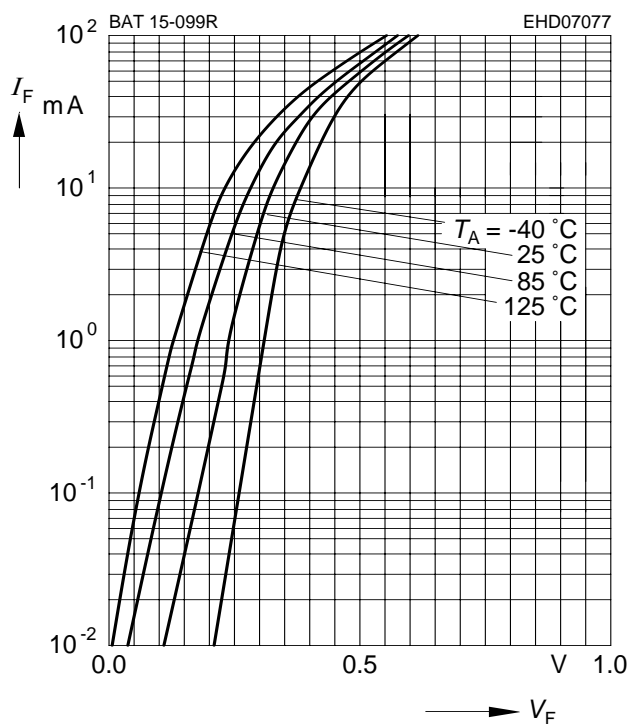

Forward current $I_F = f(T_S)$

BAT15-02LRH, BAT15-099LRH

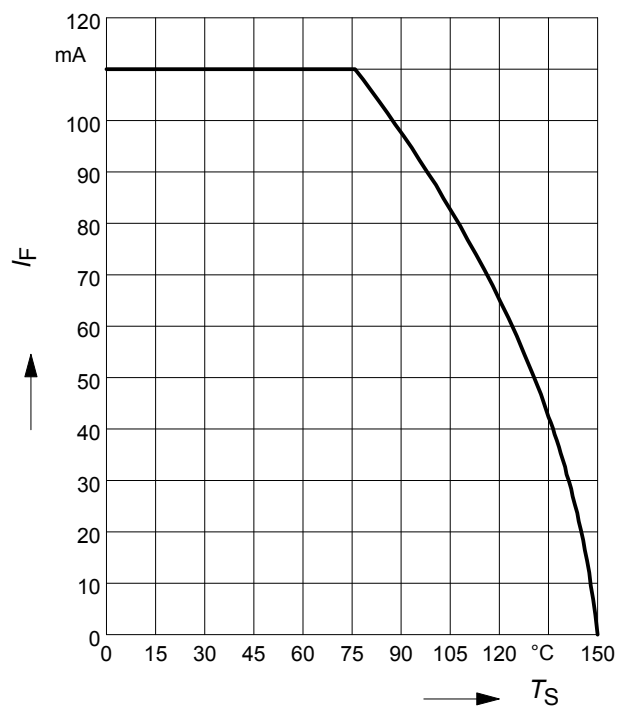

Forward current $I_F = f(T_S)$

BAT15-03W

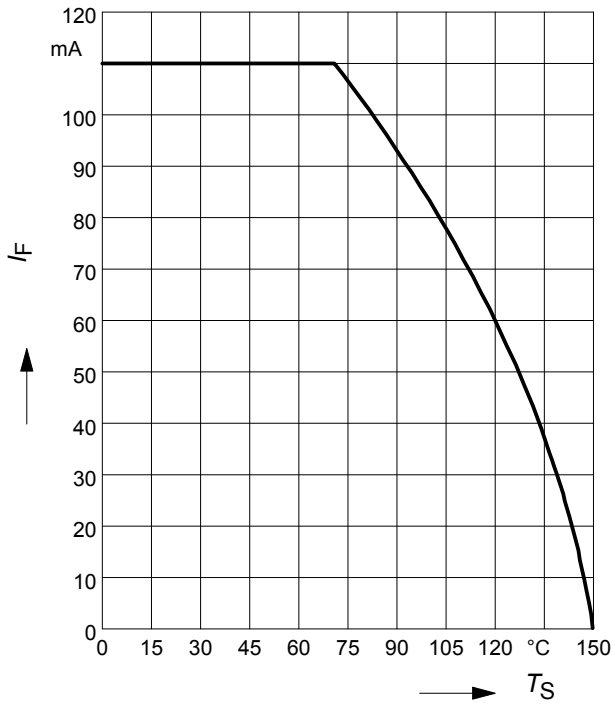

Forward current $I_F = f(T_S)$

BAT15-04W

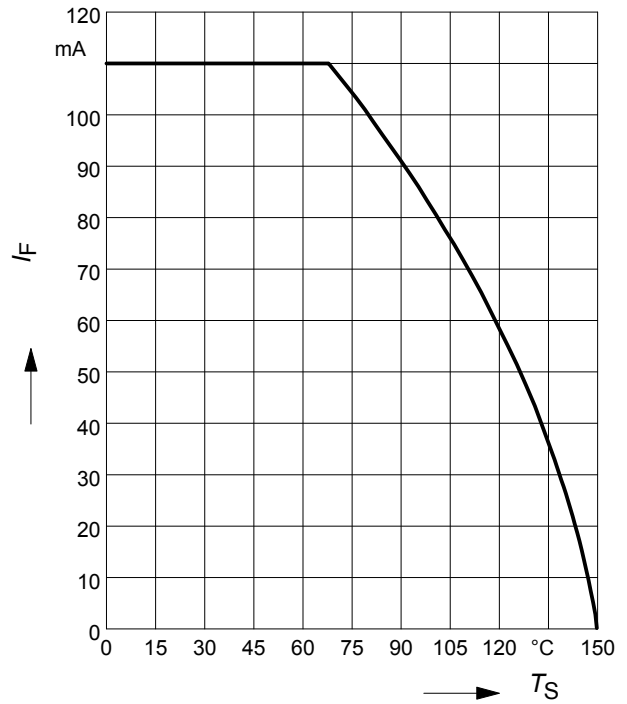

Forward current $I_F = f(T_S)$

BAT15-05W

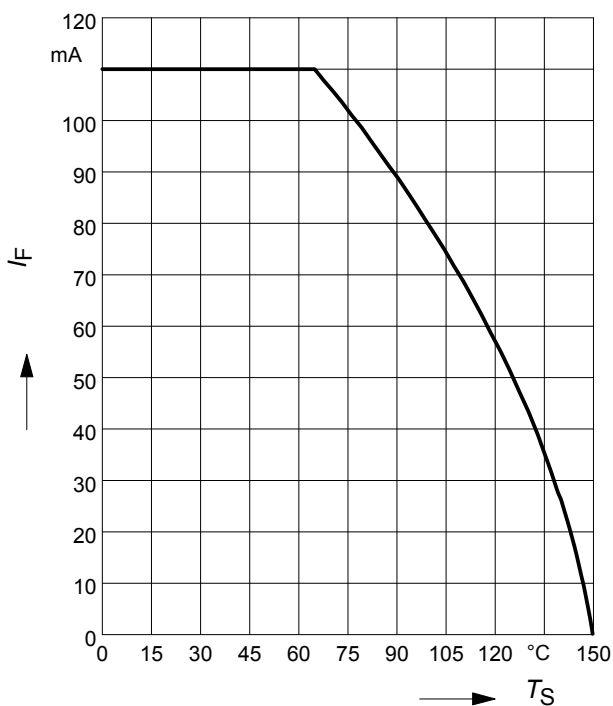

Forward current $I_F = f(T_S)$

BAT15-099

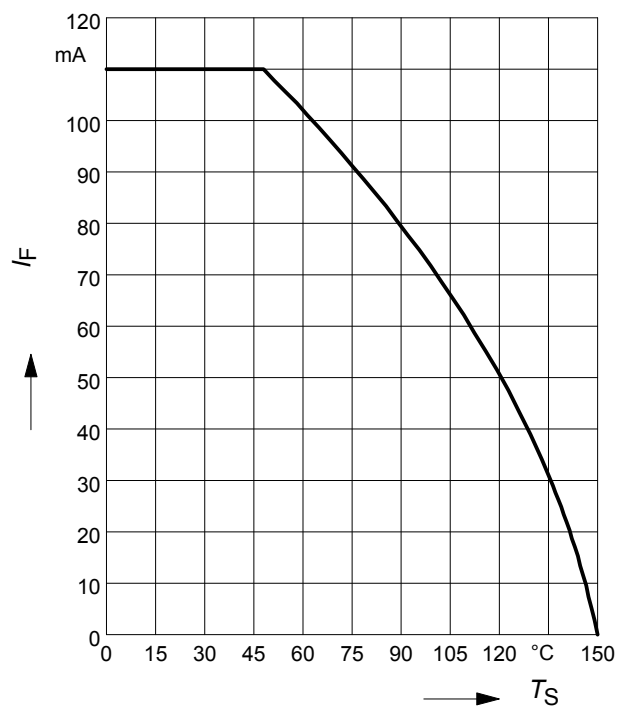

Forward current $I_F = f(T_S)$

BAT15-099R

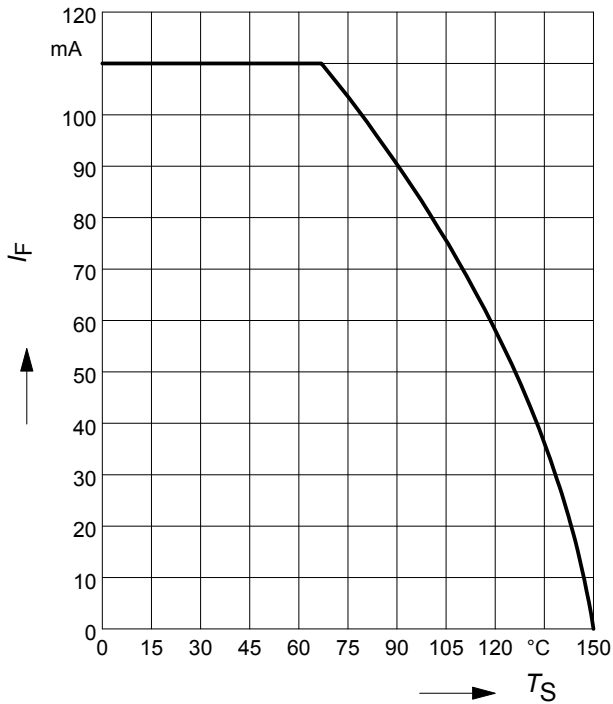

Permissible Puls Load $R_{thJS} = f(t_p)$

BAT15-02LRH, BAT15-099LRH

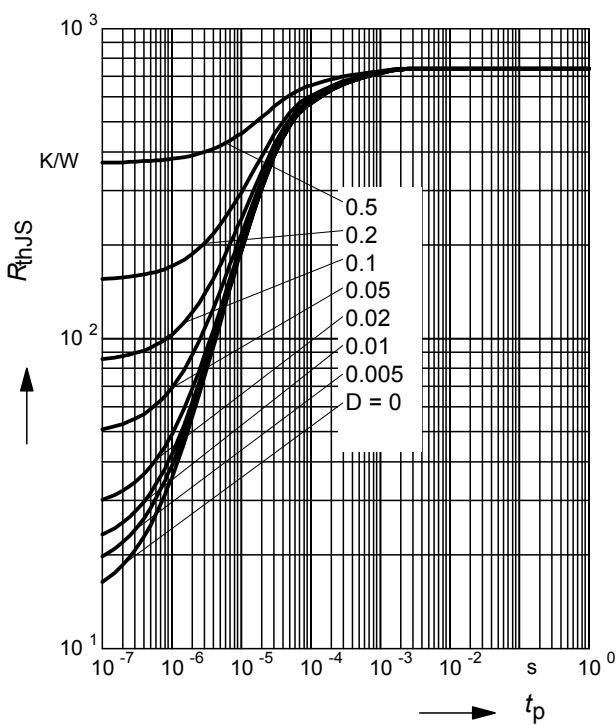

Permissible Pulse Load

$I_{Fmax}/I_{FDC} = f(t_p)$ BAT15-02LRH, BAT15-099LRH

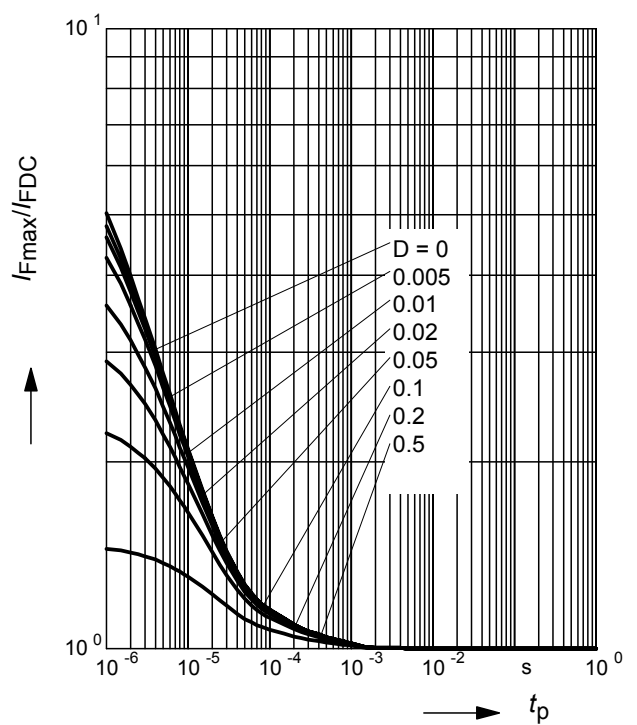

Permissible Puls Load $R_{thJS} = f(t_p)$

BAT15-03W

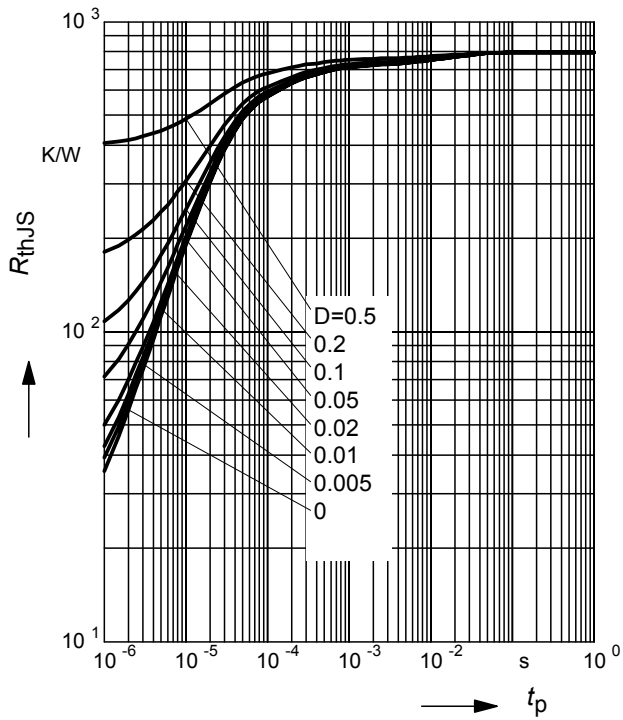

Permissible Pulse Load

$I_{Fmax} / I_{FDC} = f(t_p)$

BAT15-03W

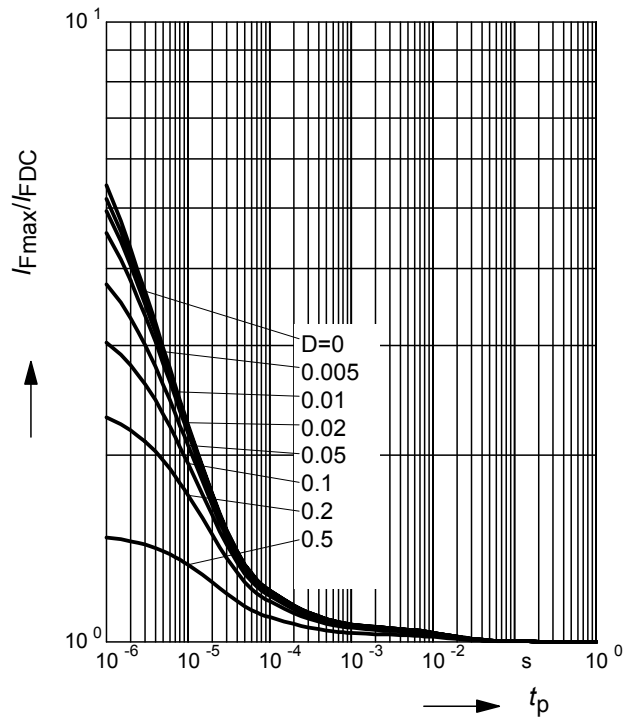

Permissible Puls Load $R_{thJS} = f(t_p)$

BAT15-04W

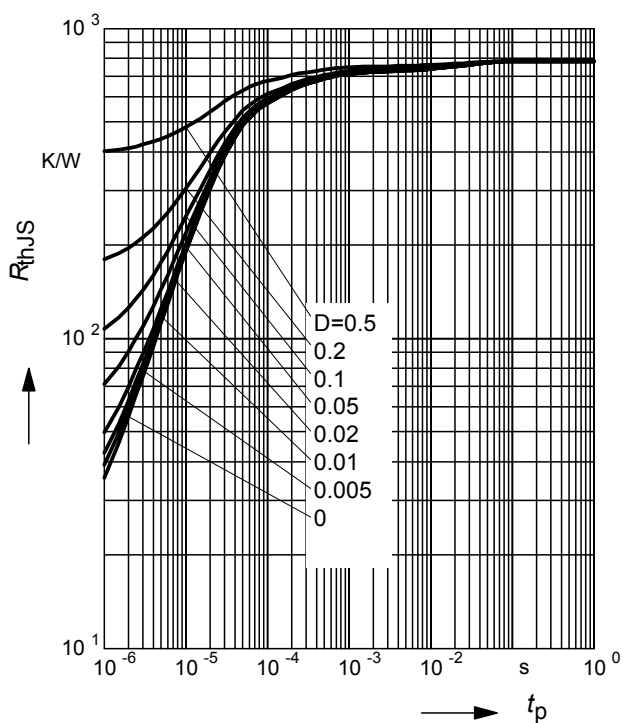

Permissible Pulse Load

$I_{Fmax} / I_{FDC} = f(t_p)$

BAT15-04W

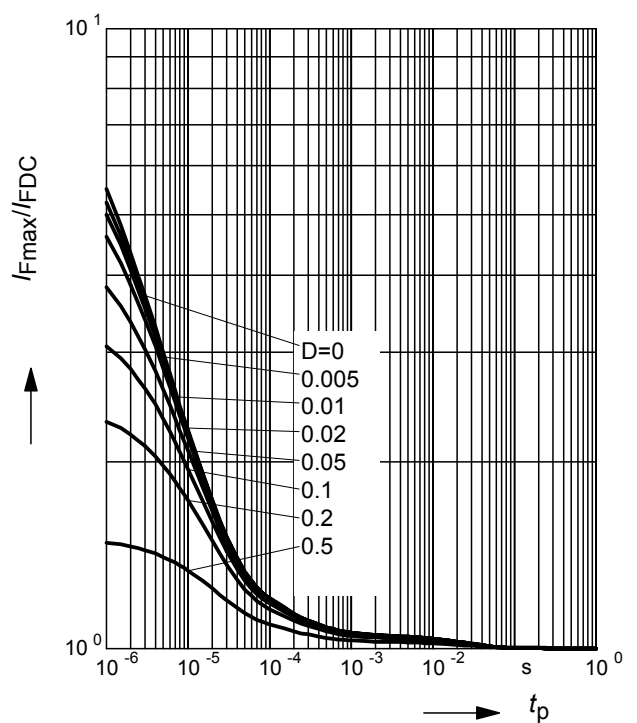

Permissible Puls Load $R_{thJS} = f(t_p)$

BAT15-05W

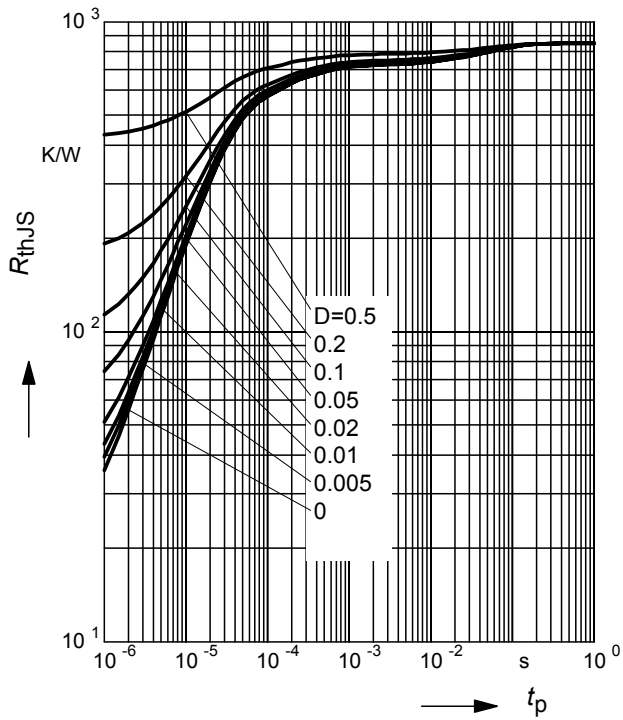

Permissible Pulse Load

$I_{Fmax} / I_{FDC} = f(t_p)$

BAT15-05W

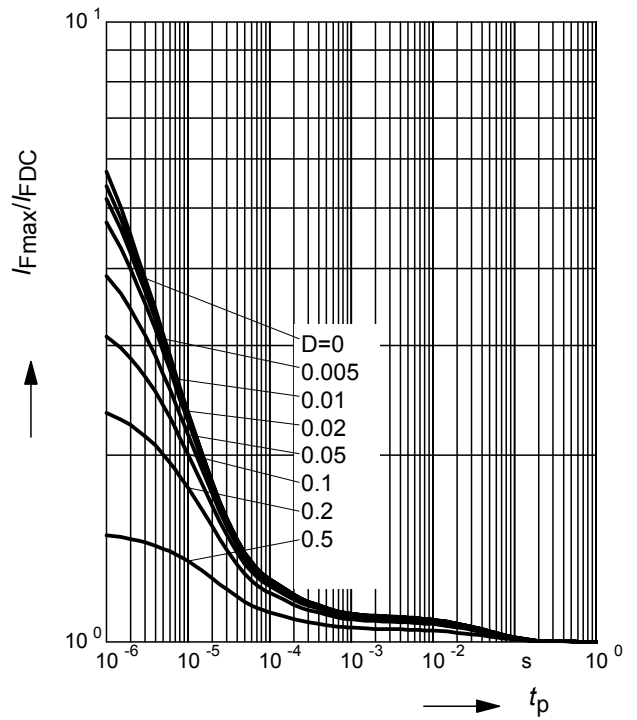

Permissible Puls Load $R_{thJS} = f(t_p)$

BAT15-099

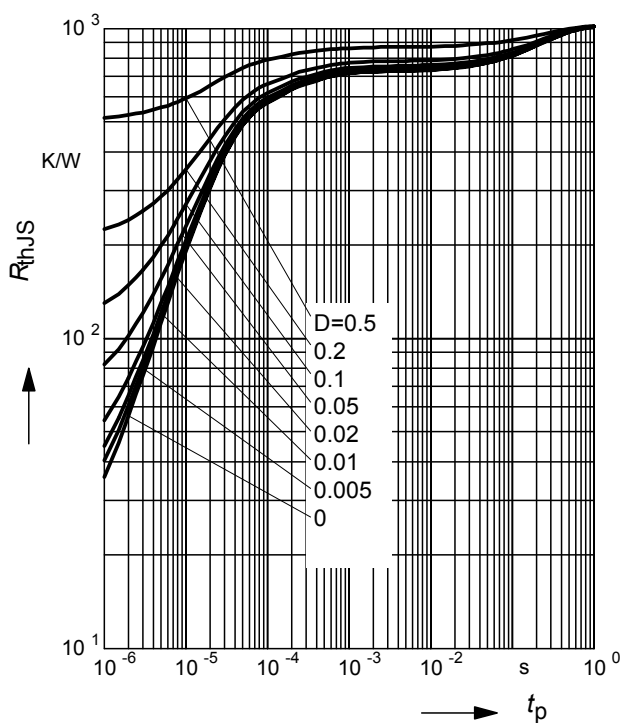

Permissible Pulse Load

$I_{Fmax} / I_{FDC} = f(t_p)$

BAT15-099

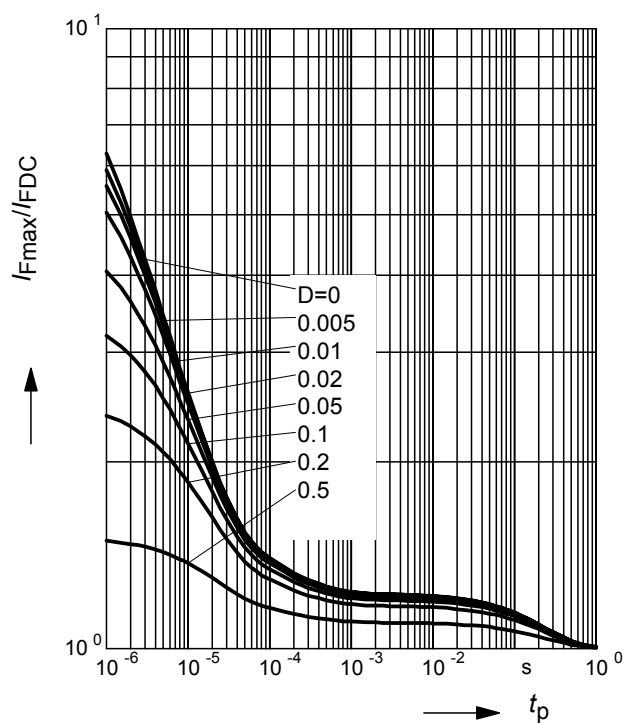

Permissible Puls Load $R_{thJS} = f(t_p)$

BAT15-099R

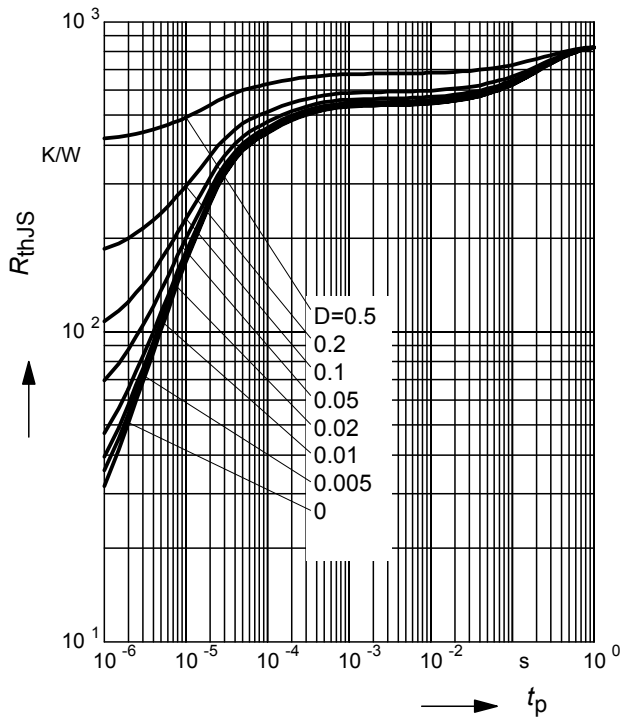

Permissible Pulse Load

$I_{Fmax} / I_{FDC} = f(t_p)$

BAT15-099R

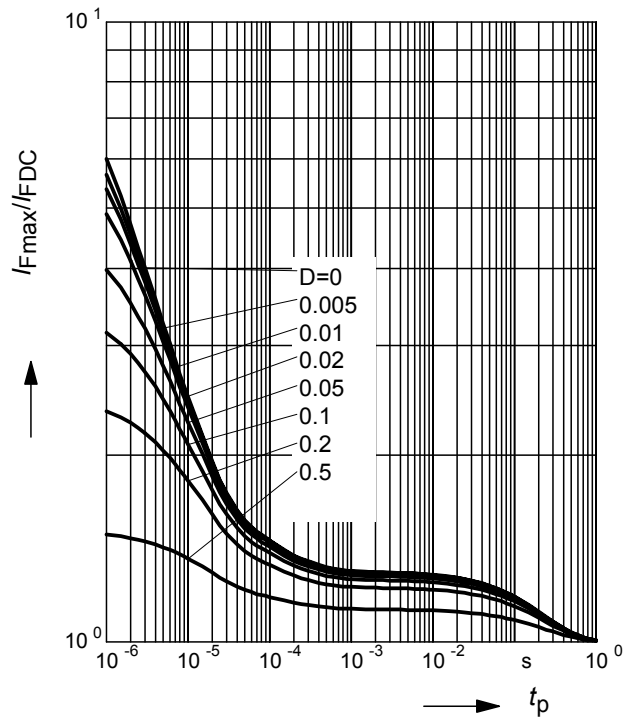

S₁₁-Parameters for BAT15-099

 Typical impedance characteristics (with external bias I and $Z_0 = 50\Omega$)

f	$I = 0.02 \text{ mA}$		$I = 0.05 \text{ mA}$		$I = 0.1 \text{ mA}$		$I = 0.2 \text{ mA}$		$I = 0.5 \text{ mA}$	
GHz	MAG	ANG	MAG	ANG	MAG	ANG	MAG	ANG	MAG	ANG
1	0.94	-16.4	0.84	-16.6	0.77	-16.4	0.59	-17.2	0.19	-16.7
2	0.93	-33.8	0.88	-33.8	0.77	-34.5	0.58	-35.2	0.15	-36.1
3	0.92	-53.8	0.86	-54.5	0.75	-54.1	0.58	-56.1	0.13	-64.8
4	0.91	-74.3	0.84	-75.3	0.72	-76.4	0.51	-78.4	0.11	-104.8
5	0.91	-96.6	0.84	-97.6	0.72	-99.1	0.53	-102.3	0.15	-135.7
6	0.91	-115.4	0.84	-116.7	0.73	-118.7	0.53	-122.9	0.18	-160.9
7	0.91	-131	0.84	-132.3	0.73	-134.1	0.54	-138.1	0.2	-168.8
8	0.91	-143	0.84	-144.5	0.73	-146.8	0.55	-150.5	0.81	179.4
9	0.91	-155.6	0.83	-150.2	0.71	-159.7	0.53	-163.9	0.18	179.4
10	0.9	-167.3	0.83	-169.7	0.71	-178.8	0.51	-175.8	0.14	151.2
11	0.89	175.5	0.8	172.6	0.7	170	0.45	164.9	0.09	105.5
12	0.88	175.5	0.76	146.5	0.62	142.8	0.39	134.2	0.14	43.6

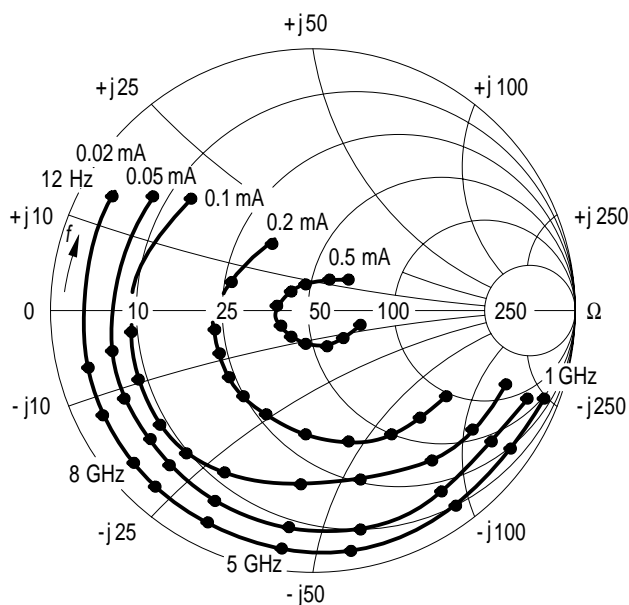
S₁₁ = (f, I) BAT15-099

EHD07083

Package Outline

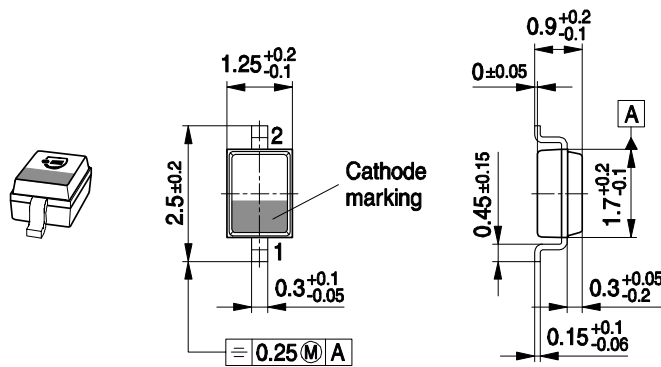

Foot Print

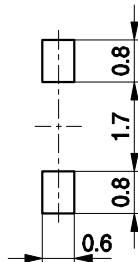

Marking Layout (Example)

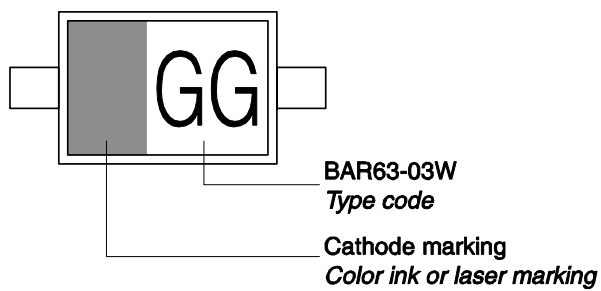

Standard Packing

Reel ø180 mm = 3.000 Pieces/Reel
 Reel ø330 mm = 10.000 Pieces/Reel

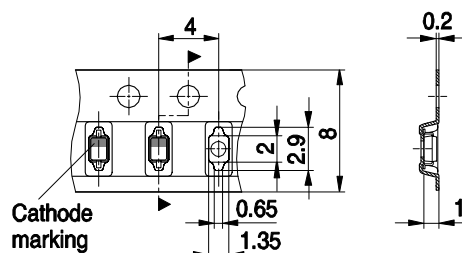

Package Outline

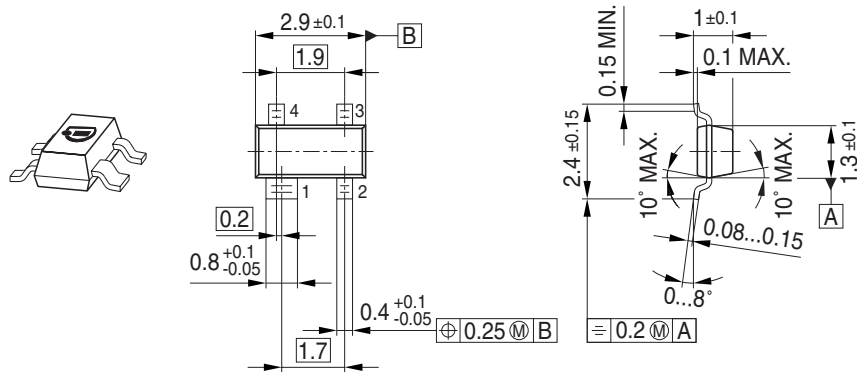

Foot Print

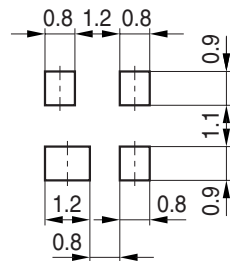

Marking Layout (Example)

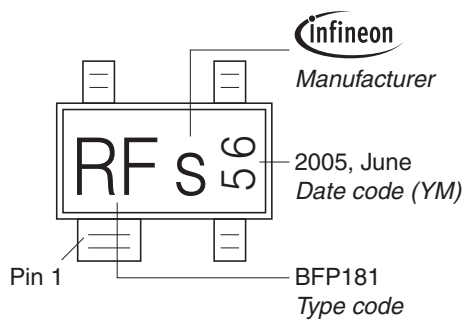

Standard Packing

Reel $\phi 180$ mm = 3.000 Pieces/Reel
 Reel $\phi 330$ mm = 10.000 Pieces/Reel

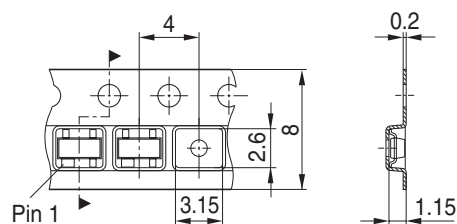

Package Outline



Foot Print



Marking Layout (Example)



Standard Packing

Reel \varnothing 180 mm = 3.000 Pieces/Reel
 Reel \varnothing 330 mm = 10.000 Pieces/Reel



Package Outline

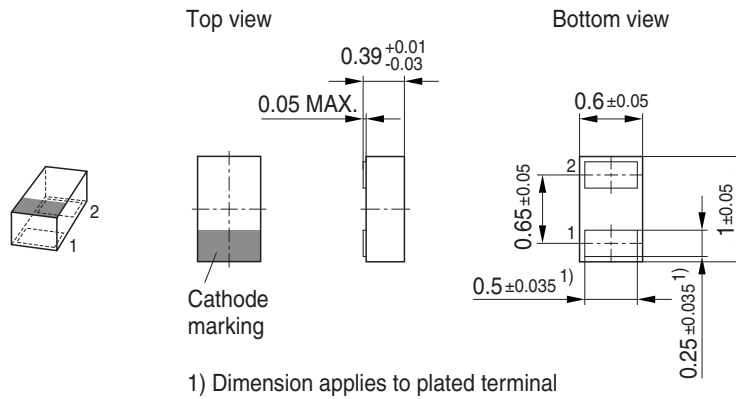

Foot Print

For board assembly information please refer to Infineon website "Packages"

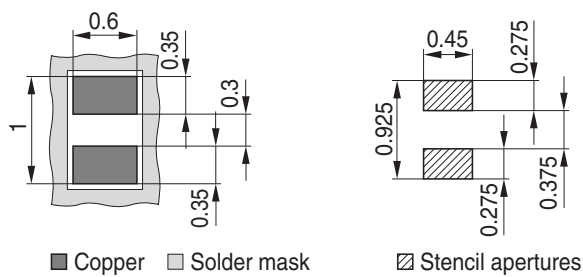

Marking Layout (Example)

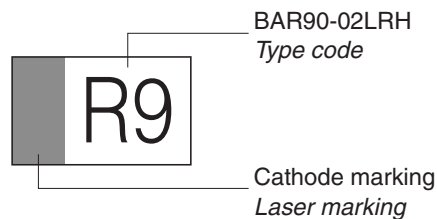

Standard Packing

Reel ø180 mm = 15.000 Pieces/Reel
 Reel ø330 mm = 50.000 Pieces/Reel (optional)



Package Outline

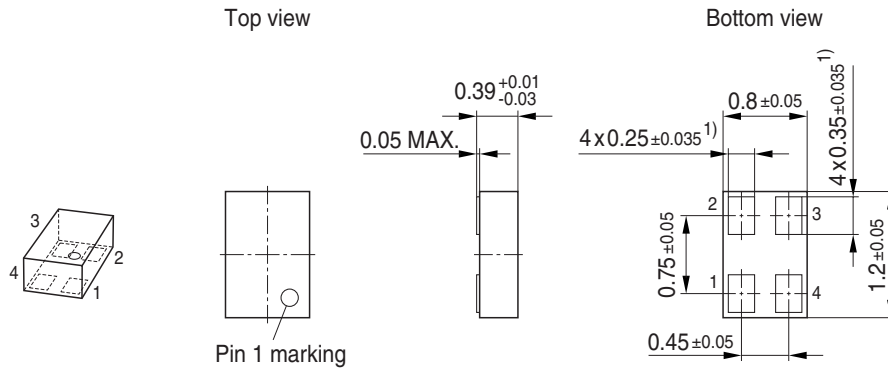

1) Dimension applies to plated terminal

Foot Print

For board assembly information please refer to Infineon website "Packages"

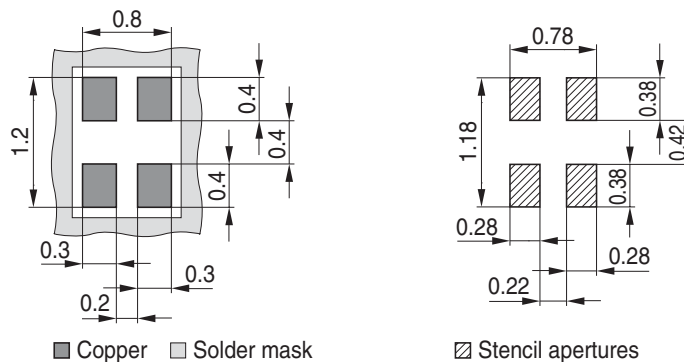

Marking Layout (Example)

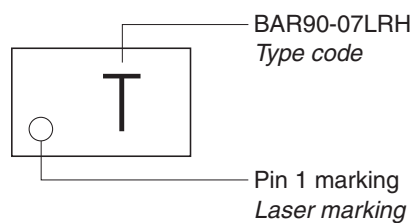

Standard Packing

Reel \varnothing 180 mm = 15.000 Pieces/Reel

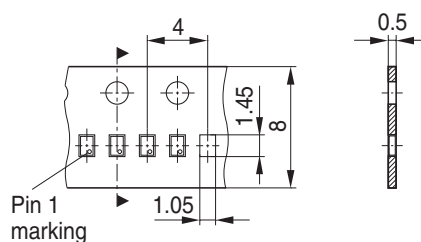

Edition 2009-11-16

**Published by
Infineon Technologies AG
81726 Munich, Germany**

**© 2009 Infineon Technologies AG
All Rights Reserved.**

Legal Disclaimer

The information given in this document shall in no event be regarded as a guarantee of conditions or characteristics. With respect to any examples or hints given herein, any typical values stated herein and/or any information regarding the application of the device, Infineon Technologies hereby disclaims any and all warranties and liabilities of any kind, including without limitation, warranties of non-infringement of intellectual property rights of any third party.

Information

For further information on technology, delivery terms and conditions and prices, please contact the nearest Infineon Technologies Office (www.infineon.com).

Warnings

Due to technical requirements, components may contain dangerous substances. For information on the types in question, please contact the nearest Infineon Technologies Office.

Infineon Technologies components may be used in life-support devices or systems only with the express written approval of Infineon Technologies, if a failure of such components can reasonably be expected to cause the failure of that life-support device or system or to affect the safety or effectiveness of that device or system. Life support devices or systems are intended to be implanted in the human body or to support and/or maintain and sustain and/or protect human life. If they fail, it is reasonable to assume that the health of the user or other persons may be endangered.



Компания «ЭлектроПласт» предлагает заключение долгосрочных отношений при поставках импортных электронных компонентов на взаимовыгодных условиях!

Наши преимущества:

- Оперативные поставки широкого спектра электронных компонентов отечественного и импортного производства напрямую от производителей и с крупнейших мировых складов;
- Поставка более 17-ти миллионов наименований электронных компонентов;
- Поставка сложных, дефицитных, либо снятых с производства позиций;
- Оперативные сроки поставки под заказ (от 5 рабочих дней);
- Экспресс доставка в любую точку России;
- Техническая поддержка проекта, помощь в подборе аналогов, поставка прототипов;
- Система менеджмента качества сертифицирована по Международному стандарту ISO 9001;
- Лицензия ФСБ на осуществление работ с использованием сведений, составляющих государственную тайну;
- Поставка специализированных компонентов (Xilinx, Altera, Analog Devices, Intersil, Interpoint, Microsemi, Aeroflex, Peregrine, Syfer, Eurofarad, Texas Instrument, Miteq, Cobham, E2V, MA-COM, Hittite, Mini-Circuits, General Dynamics и др.);

Помимо этого, одним из направлений компании «ЭлектроПласт» является направление «Источники питания». Мы предлагаем Вам помощь Конструкторского отдела:

- Подбор оптимального решения, техническое обоснование при выборе компонента;
- Подбор аналогов;
- Консультации по применению компонента;
- Поставка образцов и прототипов;
- Техническая поддержка проекта;
- Защита от снятия компонента с производства.



Как с нами связаться

Телефон: 8 (812) 309 58 32 (многоканальный)

Факс: 8 (812) 320-02-42

Электронная почта: org@eplast1.ru

Адрес: 198099, г. Санкт-Петербург, ул. Калинина, дом 2, корпус 4, литера А.