

## Data Sheet



Lead (Pb) Free  
RoHS 6 fully  
compliant



### Description

The Power PLCC-4 SMT LED with Lens are high-performance PLCC-4 package size SMT LEDs targeted mainly in Automotive & Electronics Signs and Signals (ESS) markets. These top-mount single-chip packages with focused radiation offer high brightness in beam direction and are excellent for interior automotive, indoor and outdoor sign and industrial applications. With additional lens in 30° variants, these products are especially fitting to applications for traffic lights, CHMSL and displays.

The PLCC-4 package family is able to dissipate heat better compared to the PLCC-2 packages. In proportion to this increase in driving current, this family of LEDs is able to produce higher light output compared to the conventional PLCC-2 SMT LEDs.

As an extension of the standard flat top PLCC-4 SMT LEDs, the Power PLCC-4 with Lens device is able to provide focused beams within narrow viewing angles (30°) meeting the market's requirements for focused radiation and high brightness in beam directions.

The Power PLCC-4 SMT LED with 30° is ideal for panel, push button, or general backlighting in automotive interior & exterior, sign, office equipment, industrial equipment and home appliances applications. This package design coupled with careful selection of component materials allow the Power PLCC-4 SMT LED with Lens to perform with higher reliability in a larger temperature range -40°C to 100°C. This high reliability feature is crucial to allow the Power PLCC-4 SMT LED with Lens to do well in harsh environments such as its target Automotive & ESS markets. The Power PLCC4 SMT LED with Lens package is also designed to be compatible with both IR-solder re-flow and through-the-wave soldering.

### Features

- Industry Standard PLCC-4
- High reliability LED package
- High brightness using AlInGaP and InGaN dice technologies
- High optical efficiency
- Narrow Viewing angle at 30°
- Available in 8mm carrier tape on 7-inch reel
- Compatible with both IR and TTW soldering process

### Applications

#### Interior automotive

- Instrument panel backlighting
- Central console backlighting
- Cabin backlighting
- Navigation and audio system
- Dome lighting
- Push button backlighting

#### Exterior automotive

- Turn signals
- CHMSL
- Rear Combination Lamp
- Side repeaters

#### Electronic signs and signals

- Interior and exterior full color sign
- Variable message sign
- Garden lighting

#### Office automation, home appliances, industrial equipment

- Front panel backlighting
- Push button backlighting
- Display backlighting

**CAUTION:** HSMN, HSMx-A43x-xxxxx LEDs are Class 2 ESD sensitive. Please observe appropriate precautions during handling and processing. Refer to Avago Application Note AN-1142 for additional details.

The new Avago Technologies Power PLCC-4 SMT LED with 30° Lens will carry the part number HSMx- A43xxxxxx. The high brightness AllnGaP and InGaN dice technologies utilized will provide the product brightness that meets the Automotive and ESS markets requirements. The Lens package will complement and complete the existing AllnGaP & InGaN color standard Power-PLCC-4 LED that Avago Technologies offers, providing customers an extra Lens option from one supplier.

To facilitate easy pick and place assembly, the LEDs are packed in EIA-compliant tape and reel. Every reel will be shipped in single intensity and color bin (except for red color), to provide close uniformity

### Package Dimensions



### Package marking

Note: All dimensions in mm  
Electrical connection between all cathodes is recommended

## Device Selection Guide

| Color      | Part Number     | Min. $I_v$ (mcd) | Typ. $I_v$ (mcd) | Max. $I_v$ (mcd) | Test Current (mA) | Dice Technology |
|------------|-----------------|------------------|------------------|------------------|-------------------|-----------------|
| Red        | HSMC-A430-W50M1 | 1125             | 2300             | 3550             | 50                | AllInGaP        |
|            | HSMC-A431-X90M1 | 2240             | 4000             | 7150             | 50                | AllInGaP        |
|            | HSMC-A431-Y70M1 | 3550             | -                | 7150             | 50                | AllInGaP        |
|            | HSMC-A431-Y80M1 | 3550             | -                | 9000             | 50                | AllInGaP        |
| Red Orange | HSMJ-A430-W50M1 | 1125             | 2300             | 3550             | 50                | AllInGaP        |
|            | HSMJ-A431-X90M1 | 2240             | 4500             | 7150             | 50                | AllInGaP        |
|            | HSMJ-A431-X90M1 | 2240             | -                | 7150             | 50                | AllInGaP        |
|            | HSMJ-A431-Y70M1 | 3550             | -                | 7150             | 50                | AllInGaP        |
| Orange     | HSMJ-A431-X90M1 | 2240             | 4500             | 7150             | 50                | AllInGaP        |
| Amber      | HSMA-A430-W90M1 | 1400             | 3000             | 4500             | 50                | AllInGaP        |
|            | HSMA-A431-Y00M1 | 2850             | 5000             | -                | 50                | AllInGaP        |
|            | HSMA-A431-X90M1 | 2240             | 4700             | 7150             | 50                | AllInGaP        |
|            | HSMA-A431-13NM1 | 7150             | -                | 14000            | 50                | AllInGaP        |
|            | HSMA-A431-Z50M1 | 4500             | -                | 14000            | 50                | AllInGaP        |
|            | HSMA-A431-Z5WM1 | 4500             | -                | 14000            | 50                | AllInGaP        |
| Green      | HSMM-A430-X90M2 | 2240             | -                | 7150             | 30                | InGaN           |
|            | HSMM-A430-Y3YM2 | 2850             | -                | 5600             | 30                | InGaN           |
|            | HSMM-A430-Y7YM2 | 3550             | -                | 7150             | 30                | InGaN           |
| Blue       | HSMN-A430-V50M2 | 715              | -                | 2240             | 30                | InGaN           |
|            | HSMN-A430-V7YM2 | 900              | -                | 1800             | 30                | InGaN           |

### Notes:

- The luminous intensity  $I_v$  is measured at the mechanical axis of the lamp package.  
The actual peak of the spatial radiation pattern may not be aligned with this axis.
- $I_v$  tolerance  $\pm 12\%$

## Part Numbering System



### Absolute Maximum Ratings (T<sub>A</sub>=25°C)

| Parameters                          | HSMC/A              | HSMV   | HSMK/M/N |
|-------------------------------------|---------------------|--------|----------|
| DC Forward Current <sup>[1]</sup>   | 70 mA               | 70 mA  | 30 mA    |
| Peak Forward Current <sup>[2]</sup> | 200 mA              | 200 mA | 90 mA    |
| Power Dissipation                   | 180 mW              | 240 mW | 114 mW   |
| Reverse Voltage                     | 5V                  | 5V     | 4V       |
| Junction Temperature                | 110 °C              |        |          |
| Operating Temperature               | - 40 °C to + 100 °C |        |          |
| Storage Temperature                 | - 40 °C to + 100 °C |        |          |

Notes:

1. Derate linearly as shown in Figure 4.
2. Duty factor = 10%, Frequency = 1kHz

### Optical Characteristics (T<sub>A</sub> = 25 °C)

| Color      | Part Number | Dice Technology | Peak Wavelength       | Dominant Wavelength             | Viewing Angle                             | Luminous Efficacy              |
|------------|-------------|-----------------|-----------------------|---------------------------------|---|--------------------------------|
|            |             |                 | $\lambda_{PEAK}$ (nm) | $\lambda_D$ <sup>[1]</sup> (nm) | 2 $\theta_{1/2}$ <sup>[2]</sup> (Degrees) | $\eta_V$ <sup>[3]</sup> (lm/W) |
|            |             |                 | Typical               | Typical                         | Typical                                   | Typical                        |
| Red        | HSMC-A43x   | AllnGaP         | 635                   | 626                             | 30  | 150                            |
| Red Orange | HSMJ-A43x   | AllnGaP         | 621                   | 615                             | 30  | 240                            |
|            | HSMV-A430   | AllnGaP         | 623                   | 617                             | 30  | 263                            |
| Orange     | HSML-A431   | AllnGaP         | 609                   | 605                             | 30  | 320                            |
| Amber      | HSMA-A43x   | AllnGaP         | 592                   | 590                             | 30  | 480                            |
| Green      | HSMH-A430   | InGaN           | 518                   | 525                             | 30  | 500                            |
| Blue       | HSMN-A43X   | InGaN           | 468                   | 470                             | 30  | 75                             |
| Cyan       | HSMK-A43X   | InGaN           | 500                   | 502                             | 30  | 285                            |

Notes:

1. The dominant wavelength,  $\lambda_D$ , is derived from the CIE Chromaticity Diagram and represents the color of the device.
2.  $\theta_{1/2}$  is the off-axis angle where the luminous intensity is 1/2 the peak intensity.
3. Radiant intensity,  $I_e$  in watts / steradian, may be calculated from the equation  $I_e = I_v / \eta_V$ , where  $I_v$  is the luminous intensity in candelas and  $\eta_V$  is the luminous efficacy in lumens / watt.

### Electrical Characteristics (T<sub>A</sub> = 25 °C)

| Part Number | Forward Voltage V <sub>F</sub> (Volts)@I <sub>F</sub> =50 mA |         |         | Reverse Voltage V <sub>R</sub> @100 $\mu$ A | Reverse Voltage V <sub>R</sub> @10 $\mu$ A |
|-------------|--|---------|---------|---|--|
|             | Minimum  | Typical | Maximum | Minimum                                     | Minimum                                    |
| HSMC/J/L/A  | 1.7  | 2.2     | 2.5     | 5   | -  |
| HSMV        | 1.7  | 2.8     | 3.4     | 5   | -  |

| Part Number | Forward Voltage V <sub>F</sub> (Volts)@I <sub>F</sub> =30 mA |         |         | Reverse Voltage V <sub>R</sub> @100 $\mu$ A | Reverse Voltage V <sub>R</sub> @10 $\mu$ A |
|-------------|--|---------|---------|---|--|
|             | Minimum  | Typical | Maximum | Minimum                                     | Minimum                                    |
| HSMK/M/N    | 2.7  | 3.9     | 4.6     | -   | 5  |



Figure 1. Relative Intensity Vs. Wavelength



Figure 2. Forward Current Vs. Forward Voltage

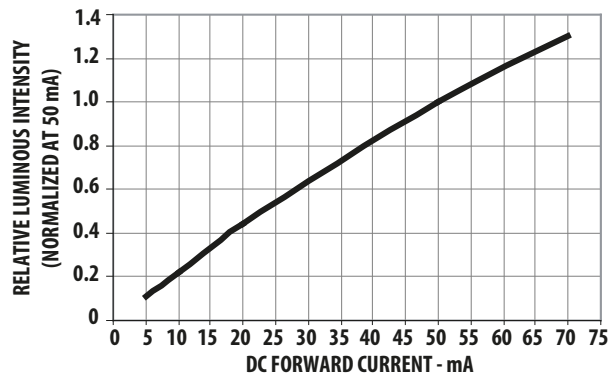

Figure 3a. Relative Intensity Vs. Forward Current (AlInGaP).

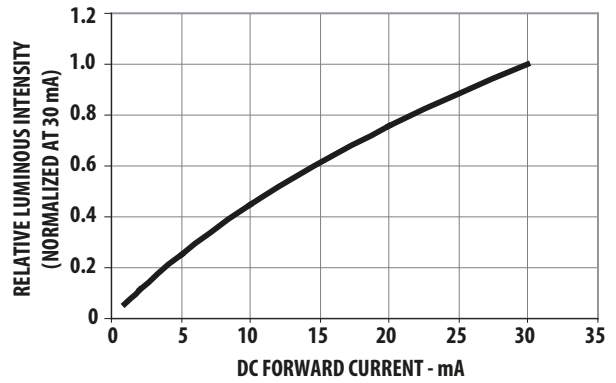

Figure 3b. Relative Intensity Vs. Forward Current (InGaN).

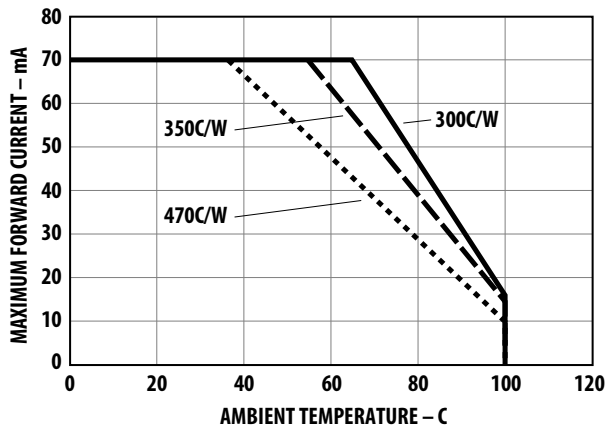

Figure 4a. Maximum Forward Current Vs. Ambient Temperature. Derated Based on  $T_{jmax}= 110^{\circ}C$  (AlInGaP)

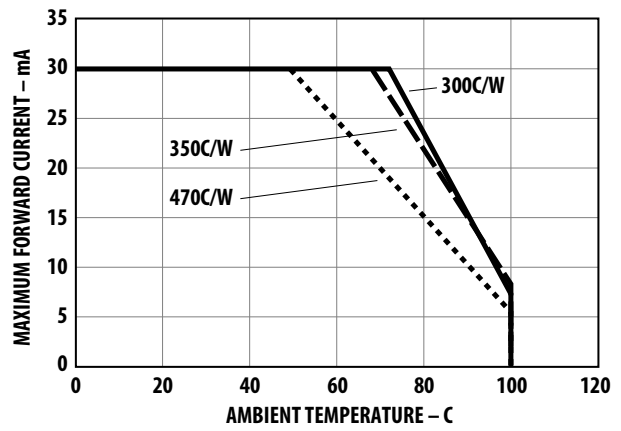

Figure 4b. Maximum Forward Current Vs. Ambient Temperature. Derated Based on  $T_{jmax}= 110^{\circ}C$  (InGaN)



Figure 5. Radiation Pattern

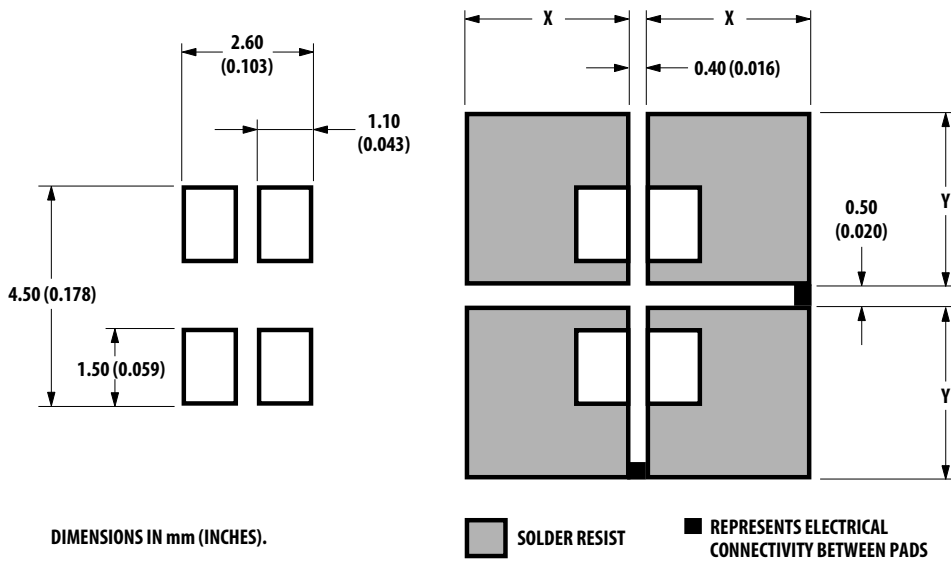

Figure 6a. Recommended Soldering Pad Pattern (IR Reflow).

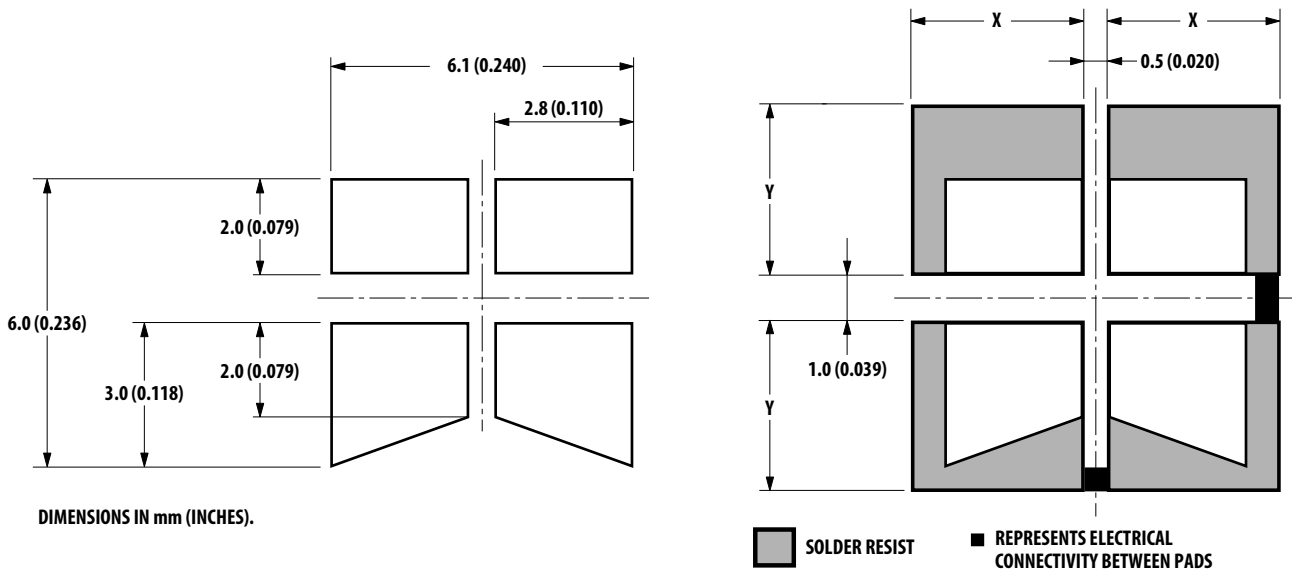

Figure 6b. Recommended Soldering Pad Pattern (TTW).



Figure 7. Soft Tip Vacuum Pick-up Tool for Extracting SMT LED Components from Carrier Tape.



Figure 8a. Recommended SnPb Reflow Soldering Profile

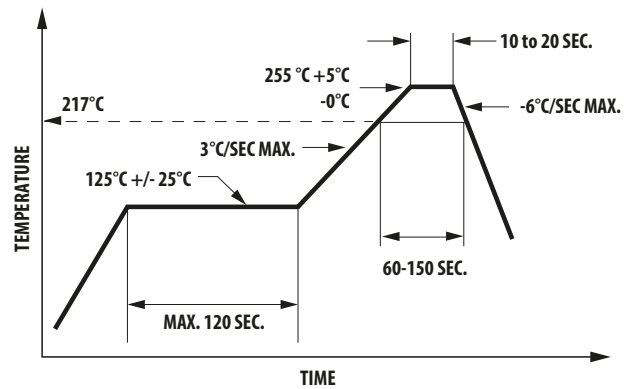

Figure 8b. Recommended Pb-free Reflow Soldering Profile.

Note: For detail information on reflow soldering of Avago surface mount LEDs, do refer to Avago Application Note AN 1060 Surface Mounting SMT LED Indicator Components.

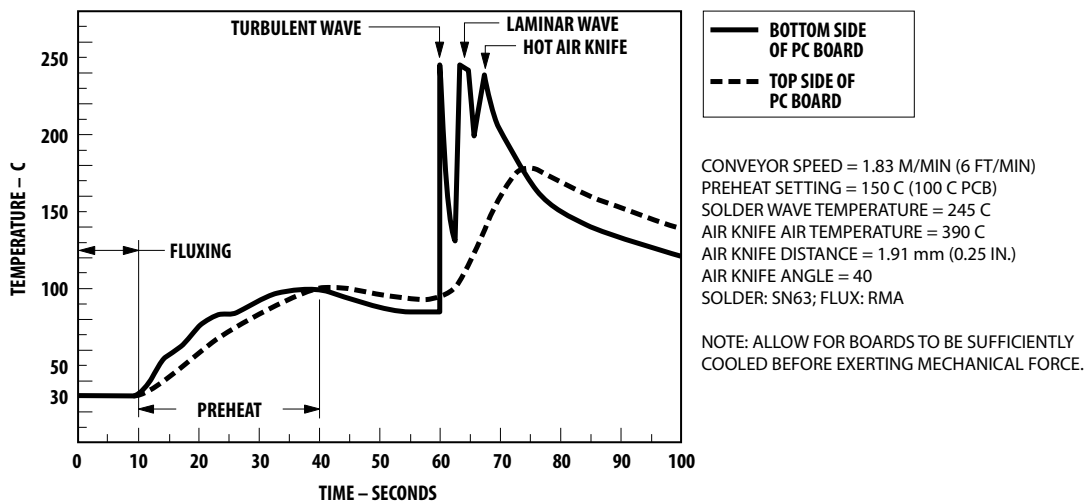

Figure 9. Recommended Wave Soldering Profile.





Figure 10. Tape Leader and Trailer Dimensions

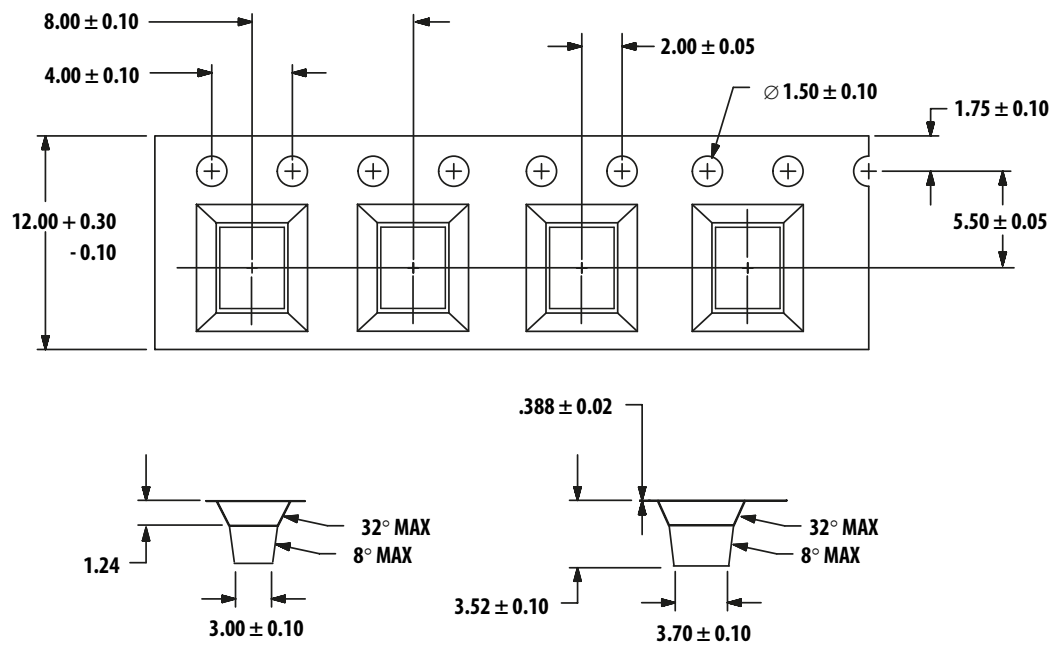

Figure 11. Tape Dimensions

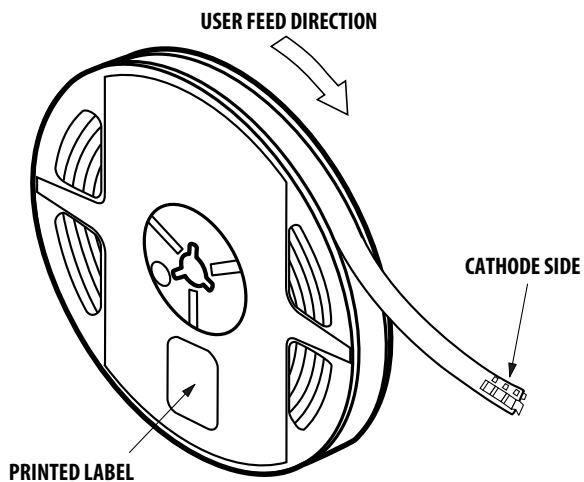

Figure 12. Reeling Orientation.

## Moisture Sensitivity

This product is qualified as Moisture Sensitive Level 2a per J-STD-020. Precautions when handling this moisture sensitive product is important to ensure the reliability of the product. Do refer to Avago Application Note AN5305 Handling of Moisture Sensitive Surface Mount Devices for details.

### A. Storage before use

- Unopen moisture barrier bag (MBB) can be stored at <math><40^{\circ}\text{C}</math>/90%RH for 12 months. If the actual shelf life has exceeded 12 months and the HIC indicates that baking is not required, then it is safe to reflow the LEDs per the original MSL rating.
- It is not recommended to open the MBB prior to assembly (e.g. for IQC).

### B. Control after opening the MBB

- The humidity indicator card (HIC) shall be read immediately upon opening of MBB.
- The LEDs must be kept at <math><30^{\circ}\text{C}</math> / 60%RH at all time and all high temperature related process including soldering, curing or rework need to be completed within 672 hours.

### C. Control for unfinished reel

- For any unused LEDs, they need to be stored in sealed MBB with desiccant or desiccator at <math><5\%</math>RH.

### D. Control of assembled boards

- If the PCB soldered with the LEDs is to be subjected to other high temperature processes, the PCB need to be stored in sealed MBB with desiccant or desiccator at <math><5\%</math>RH to ensure no LEDs have exceeded their floor life of 672 hours.

### E. Baking is required if:

- "10%" is Not blue and "5%" HIC indicator turns pink.
- The LEDs are exposed to condition of <math>>30^{\circ}\text{C}</math> / 60% RH at any time.
- The LEDs floor life exceeded 672 hours.

Recommended baking condition:  $60\pm 5^{\circ}\text{C}$  for 20 hours.

## Intensity Bin Select ( $X_5X_6$ )

Individual reel will contain parts from one half bin only

| $X_5$ | Min Iv Bin                       |
|-------|----------------------------------|
| $X_6$ |                                  |
| 0     | Full Distribution                |
| 2     | 2 half bins starting from $X_51$ |
| 3     | 3 half bins starting from $X_51$ |
| 4     | 4 half bins starting from $X_51$ |
| 5     | 5 half bins starting from $X_51$ |
| 6     | 2 half bins starting from $X_52$ |
| 7     | 3 half bins starting from $X_52$ |
| 8     | 4 half bins starting from $X_52$ |
| 9     | 5 half bins starting from $X_52$ |

## Intensity Bin Limits

| Bin ID | Min (mcd) | Max (mcd) |
|--------|-----------|-----------|
| U1     | 450.00    | 560.00    |
| U2     | 560.00    | 715.00    |
| V1     | 715.00    | 900.00    |
| V2     | 900.00    | 1125.00   |
| W1     | 1125.00   | 1400.00   |
| W2     | 1400.00   | 1800.00   |
| X1     | 1800.00   | 2240.00   |
| X2     | 2240.00   | 2850.00   |
| Y1     | 2850.00   | 3550.00   |
| Y2     | 3550.00   | 4500.00   |
| Z1     | 4500.00   | 5600.00   |
| Z2     | 5600.00   | 7150.00   |
| 11     | 7150.00   | 9000.00   |
| 12     | 9000.00   | 11250.00  |
| 21     | 11250.00  | 14000.00  |
| 22     | 14000.00  | 18000.00  |

Tolerance of each bin limit =  $\pm 12\%$

## Color Bin Select (X<sub>7</sub>)

Individual reel will contain parts from 1 full bin only

| X <sub>7</sub> |                    |
|----------------|--------------------|
| 0              | Full Distribution  |
| Z              | A and B only       |
| Y              | B and C only       |
| W              | C and D only       |
| V              | D and E only       |
| U              | E and F only       |
| T              | F and G only       |
| S              | G and H only       |
| Q              | A, B and C only    |
| P              | B, C and D only    |
| N              | C, D and E only    |
| M              | D, E and F only    |
| L              | E, F and G only    |
| K              | F, G and H only    |
| 1              | A, B, C and D only |
| 2              | E, F G and H only  |

## Color Bin Limits

| Blue | Min. (nm) | Max. (nm) |
|------|-----------|-----------|
| A    | 460.0     | 465.0     |
| B    | 465.0     | 470.0     |
| C    | 470.0     | 475.0     |
| D    | 475.0     | 480.0     |

| Cyan | Min. (nm) | Max. (nm) |
|------|-----------|-----------|
| A    | 490.0     | 495.0     |
| B    | 495.0     | 500.0     |
| C    | 500.0     | 505.0     |
| D    | 505.0     | 510.0     |

| Green | Min. (nm) | Max. (nm) |
|-------|-----------|-----------|
| A     | 515.0     | 520.0     |
| B     | 520.0     | 525.0     |
| C     | 525.0     | 530.0     |
| D     | 530.0     | 535.0     |

| Amber | Min. (nm) | Max. (nm) |
|-------|-----------|-----------|
| A     | 582.0     | 584.5     |
| B     | 584.5     | 587.0     |
| C     | 587.0     | 589.5     |
| D     | 589.5     | 592.0     |
| E     | 592.0     | 594.5     |
| F     | 594.5     | 597.0     |

| Orange | Min. (nm) | Max. (nm) |
|--------|-----------|-----------|
| A      | 597.0     | 600.0     |
| B      | 600.0     | 603.0     |
| C      | 603.0     | 606.0     |
| D      | 606.0     | 609.0     |
| E      | 609.0     | 612.0     |

| Red/Orange | Min. (nm) | Max. (nm) |
|------------|-----------|-----------|
| A          | 611.0     | 616.0     |
| B          | 616.0     | 620.0     |

| Red               | Min. (nm) | Max. (nm) |
|-------------------|-----------|-----------|
| Full Distribution |           |           |

Tolerance of each bin limit = ±1nm

## Packaging Option (X<sub>8</sub>X<sub>9</sub>)

| Option | Test Current | Package Type | Reel Size |
|--------|--------------|--------------|-----------|
| M1     | 50mA         | Top Mount    | 13 inch   |
| M2     | 30mA         | Top Mount    | 13 inch   |

## Forward Voltage Bin Table

For HSMV – A43x-xxxxx only

| Bin | Min. | Max. |
|-----|------|------|
| VA  | 1.9  | 2.2  |
| VB  | 2.2  | 2.5  |
| VC  | 2.5  | 2.8  |
| VD  | 2.8  | 3.1  |
| VE  | 3.1  | 3.4  |

Tolerance for each bin limit = ± 0.1V

For product information and a complete list of distributors, please go to our web site: [www.avagotech.com](http://www.avagotech.com)

Avago, Avago Technologies, and the A logo are trademarks of Avago Technologies in the United States and other countries. Data subject to change. Copyright © 2005-2014 Avago Technologies. All rights reserved. Obsoletes AV01-0313EN AV02-0208EN - December 16, 2014

**AVAGO**  
TECHNOLOGIES



Компания «ЭлектроПласт» предлагает заключение долгосрочных отношений при поставках импортных электронных компонентов на взаимовыгодных условиях!

Наши преимущества:

- Оперативные поставки широкого спектра электронных компонентов отечественного и импортного производства напрямую от производителей и с крупнейших мировых складов;
- Поставка более 17-ти миллионов наименований электронных компонентов;
- Поставка сложных, дефицитных, либо снятых с производства позиций;
- Оперативные сроки поставки под заказ (от 5 рабочих дней);
- Экспресс доставка в любую точку России;
- Техническая поддержка проекта, помощь в подборе аналогов, поставка прототипов;
- Система менеджмента качества сертифицирована по Международному стандарту ISO 9001;
- Лицензия ФСБ на осуществление работ с использованием сведений, составляющих государственную тайну;
- Поставка специализированных компонентов (Xilinx, Altera, Analog Devices, Intersil, Interpoint, Microsemi, Aeroflex, Peregrine, Syfer, Eurofarad, Texas Instrument, Miteq, Cobham, E2V, MA-COM, Hittite, Mini-Circuits, General Dynamics и др.);

Помимо этого, одним из направлений компании «ЭлектроПласт» является направление «Источники питания». Мы предлагаем Вам помощь Конструкторского отдела:

- Подбор оптимального решения, техническое обоснование при выборе компонента;
- Подбор аналогов;
- Консультации по применению компонента;
- Поставка образцов и прототипов;
- Техническая поддержка проекта;
- Защита от снятия компонента с производства.



#### Как с нами связаться

**Телефон:** 8 (812) 309 58 32 (многоканальный)

**Факс:** 8 (812) 320-02-42

**Электронная почта:** [org@eplast1.ru](mailto:org@eplast1.ru)

**Адрес:** 198099, г. Санкт-Петербург, ул. Калинина, дом 2, корпус 4, литера А.