

FEATURES

Accurate monitoring of up to four power supply voltages
6 factory-set threshold options: -5.0 V , $+1.8\text{ V}$, $+2.5\text{ V}$, $+3.0\text{ V}$, $+3.3\text{ V}$, and $+5.0\text{ V}$
Adjustable input threshold options: -0.5 V ($\pm 2.0\%$ accuracy), $+0.62\text{ V}$ ($\pm 0.8\%$ accuracy), and $+1.23\text{ V}$
200 ms typical reset timeout
Open-drain $\overline{\text{RESET}}$ output (10 μA internal pull-up)
Reset output stage: active low, valid to $\text{IN}_1 = 1\text{ V}$ or $\text{IN}_2 = 1\text{ V}$
Low power consumption (55 μA)
Glitch immunity
Specified from -40°C to $+85^\circ\text{C}$
6-lead SOT-23 package

APPLICATIONS

Telecommunications
Microprocessor systems
Data storage equipment
Servers/workstations

GENERAL DESCRIPTION

The ADM6339 is a high accuracy supervisory circuit capable of monitoring up to four system supply voltages.

The ADM6339 incorporates a variety of internally pretrimmed undervoltage threshold options for monitoring -5.0 V , $+1.8\text{ V}$, $+2.5\text{ V}$, $+3.0\text{ V}$, $+3.3\text{ V}$, and $+5.0\text{ V}$ supply voltages. Tolerance levels of $\pm 5\%$ and $\pm 10\%$ are available. The device is also available with one to three adjustable threshold options. The adjustable voltage threshold options are $+1.23\text{ V}$, $+0.62\text{ V}$, and -0.5 V . See the Ordering Guide section for a list and description of all available options.

If a monitored power supply voltage decreases below the minimum voltage threshold (or rises above the maximum voltage threshold for the -0.5 V and -5.0 V input options), a single

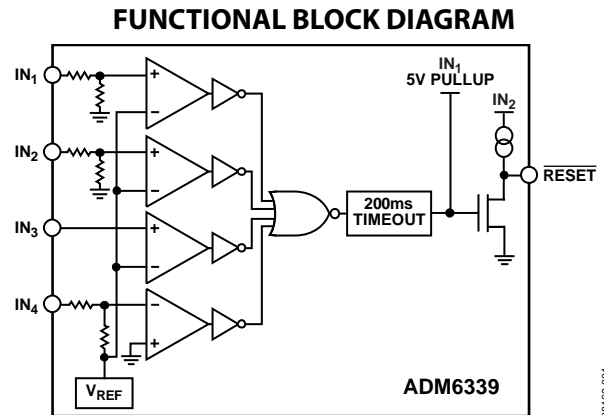

Figure 1.

active low output asserts, triggering a system reset. The output is open drain with a weak internal pull-up to the monitored IN_2 supply of typically $10\text{ }\mu\text{A}$. After all voltages exceed the selected threshold level, the reset signal remains low for the reset timeout period (200 ms typical).

The ADM6339 output remains valid as long as IN_1 or IN_2 exceeds 1 V. Unused monitored inputs should not be allowed to float or to be grounded; instead, they should be connected to a supply voltage greater than their specified threshold voltages.

The ADM6339 is available in a 6-lead SOT-23 package. The device operates over the extended temperature range of -40°C to $+85^\circ\text{C}$.

Rev. A

Information furnished by Analog Devices is believed to be accurate and reliable. However, no responsibility is assumed by Analog Devices for its use, nor for any infringements of patents or other rights of third parties that may result from its use. Specifications subject to change without notice. No license is granted by implication or otherwise under any patent or patent rights of Analog Devices. Trademarks and registered trademarks are the property of their respective owners.

TABLE OF CONTENTS

| | | | |
|---|---|---|----|
| Features | 1 | Typical Performance Characteristics | 6 |
| Applications | 1 | Theory of Operation | 8 |
| Functional Block Diagram | 1 | Input Configuration | 8 |
| General Description | 1 | Monitoring Negative Voltages < -5.0 V | 8 |
| Revision History | 2 | User Adjustable Threshold Options | 8 |
| Specifications | 3 | RESET Output Configuration | 9 |
| Absolute Maximum Ratings | 4 | Outline Dimensions | 10 |
| ESD Caution | 4 | Ordering Guide | 10 |
| Pin Configuration and Function Descriptions | 5 | | |

REVISION HISTORY

10/10—Rev. 0 to Rev. A

Added Figure 19..... 10

6/09—Revision 0: Initial Version

SPECIFICATIONS

$V_{IN2} = 1.0\text{ V to }5.5\text{ V}$, $T_A = -40^\circ\text{C to }+85^\circ\text{C}$, unless otherwise noted. Typical values are $V_{IN2} = 3.0\text{ V to }3.3\text{ V}$, $T_A = 25^\circ\text{C}$.

Table 1.

| Parameter | Min | Typ | Max | Units | Test Conditions/Comments |
|--|----------------------|--------|--------|------------|--|
| OPERATING VOLTAGE RANGE (V_{IN2}) ^{1, 2} | 1.0 | | 5.5 | V | |
| INPUT CURRENT | | | | | |
| IN _x Input Current | | 25 | 40 | μA | V_{INx} = nominal input voltage for 1.8 V, 2.5 V, and 5.0 V supplies. |
| | | 55 | 115 | μA | V_{IN2} = nominal input voltage for 3.0 V and 3.3 V supplies. V_{IN2} is also the device power supply. The supply splits into 25 μA for the resistor divider and 30 μA for other circuits. |
| | -0.1 | | +0.1 | μA | $V_{INx} = 0\text{ V to }V_{IN2}$ (input threshold voltage = 1.23 V). |
| | | 0.4 | 1.5 | μA | $V_{IN1} = 1.5\text{ V}$ (ADM6339K and ADM6639L models only). |
| | | -15 | -20 | μA | $V_{INx} = -5.0\text{ V}$ (IN _x input threshold voltage = -5.0 V). |
| | -0.1 | | +0.1 | μA | $V_{INx} = 0.62\text{ V}$ (IN _x input threshold voltage = 0.62 V). |
| | -1 | -3 | -5 | μA | $V_{INx} = -0.5\text{ V}$ (IN _x input threshold voltage = -0.5 V). |
| THRESHOLD VOLTAGE | | | | | |
| Fixed Threshold Voltage (V_{TH}) | 4.50 | 4.63 | 4.75 | V | 5.0 V (-5% tolerance) threshold. |
| V_{INx} Decreasing | 4.25 | 4.38 | 4.50 | V | 5.0 V (-10% tolerance) threshold. |
| | 3.00 | 3.08 | 3.15 | V | 3.3 V (-5% tolerance) threshold. |
| | 2.85 | 2.93 | 3.00 | V | 3.3 V (-10% tolerance) threshold. |
| | 2.70 | 2.78 | 2.85 | V | 3.0 V (-5% tolerance) threshold. |
| | 2.55 | 2.63 | 2.70 | V | 3.0 V (-10% tolerance) threshold. |
| | 2.13 | 2.19 | 2.25 | V | 2.5 V (-10% tolerance) threshold. |
| | 1.53 | 1.58 | 1.62 | V | 1.8 V (-10% tolerance) threshold. |
| V_{INx} Increasing | -4.75 | -4.63 | -4.50 | V | -5.0 V (+5% tolerance) threshold. |
| | -4.50 | -4.38 | -4.25 | V | -5.0 V (+10% tolerance) threshold. |
| Adjustable Threshold Voltage (V_{TH}) | | | | | |
| V_{INx} Decreasing | 1.20 | 1.23 | 1.26 | V | |
| | 0.615 | 0.620 | 0.625 | V | |
| V_{INx} Increasing | -0.497 | -0.487 | -0.477 | V | -0.5 V threshold. |
| RESET THRESHOLD HYSTERESIS (V_{HYST}) | | 0.3 | | % V_{TH} | |
| | | 0.47 | | % V_{TH} | IN ₄ , ADM6339Q model. |
| RESET THRESHOLD TEMPERATURE COEFFICIENT (TCV_{TH}) | | 60 | | ppm/°C | |
| IN _x to RESET DELAY (t_{RD}) | | 30 | | μs | $V_{INx} = V_{TH}$ to ($V_{TH} - 50\text{ mV}$) for all inputs except -0.5 V and -5.0 V; $V_{INx} = V_{TH}$ to ($V_{TH} + 50\text{ mV}$) for -5.0 V and -0.5 V inputs only. |
| RESET TIMEOUT PERIOD (t_{RP}) | 140 | 200 | 280 | ms | |
| RESET OUTPUT LOW (V_{OL}) | | | 0.4 | V | $V_{IN2} = 5.0\text{ V}$, $I_{SINK} = 2\text{ mA}$. |
| | | | 0.4 | V | $V_{IN2} = 2.5\text{ V}$, $I_{SINK} = 1.2\text{ mA}$. |
| | | | 0.4 | V | $V_{IN2} = V_{IN1} = 1\text{ V}$, $I_{SINK} = 50\text{ μA}$. |
| | | | 0.4 | V | $V_{IN1} = 1\text{ V}$, $V_{IN2} = 0\text{ V}$, $I_{SINK} = 20\text{ μA}$ |
| | | | 0.4 | V | $V_{IN1} = 0\text{ V}$, $V_{IN2} = 1\text{ V}$, $I_{SINK} = 20\text{ μA}$ |
| RESET OUTPUT HIGH (V_{OH}) | $0.8 \times V_{IN2}$ | | | V | $V_{IN2} \geq 2.55\text{ V}$, $I_{SOURCE} = 6\text{ μA}$, RESET not asserted. |
| RESET OUTPUT HIGH SOURCE CURRENT (I_{OH}) | | 10 | | μA | $V_{IN2} \geq 2.55\text{ V}$, RESET not asserted. |

¹ The device is powered by Input IN₂.

² The RESET output is guaranteed to be in the correct state for IN₁ or IN₂ down to 1 V.

ADM6339

ABSOLUTE MAXIMUM RATINGS

Table 2.

| Parameter | Rating |
|---|-----------------|
| V_{CC} , $\overline{\text{RESET}}$, GND | -0.3 V to +6 V |
| Continuous $\overline{\text{RESET}}$ Current | 20 mA |
| I_{N_x} (Positive Reset Threshold) | -0.3 V to +6 V |
| I_{N_4} (Negative Reset Threshold, -5 V) | -6 V to +0.3 V |
| I_{N_4} ADM6339Q Model (Negative Reset Threshold, -0.5 V) | -2 V to +0.3 V |
| Storage Temperature Range | -65°C to +125°C |
| Operating Temperature Range | -40°C to +85°C |
| Lead Temperature (10 sec) | 300°C |
| Junction Temperature | 135°C |

Stresses above those listed under Absolute Maximum Ratings may cause permanent damage to the device. This is a stress rating only; functional operation of the device at these or any other conditions above those indicated in the operational section of this specification is not implied. Exposure to absolute maximum rating conditions for extended periods may affect device reliability.

Table 3. Thermal Resistance

| Package Type | θ_{JA} | Unit |
|---------------|---------------|------|
| 6-Lead SOT-23 | 169.5 | °C/W |

ESD CAUTION



ESD (electrostatic discharge) sensitive device. Charged devices and circuit boards can discharge without detection. Although this product features patented or proprietary protection circuitry, damage may occur on devices subjected to high energy ESD. Therefore, proper ESD precautions should be taken to avoid performance degradation or loss of functionality.

PIN CONFIGURATION AND FUNCTION DESCRIPTIONS

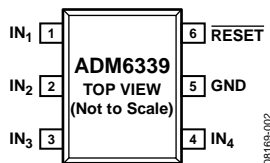

Figure 2. Pin Configuration

Table 4. Pin Function Descriptions

| Pin No. | Mnemonic | Description |
|---------|---------------------------|--|
| 1 | IN ₁ | Monitored Input Voltage 1. |
| 2 | IN ₂ | Monitored Input Voltage 2. IN ₂ is the power supply input for the ADM6339. |
| 3 | IN ₃ | Monitored Input Voltage 3. |
| 4 | IN ₄ | Monitored Input Voltage 4. |
| 5 | GND | Ground. |
| 6 | $\overline{\text{RESET}}$ | Active Low $\overline{\text{RESET}}$ Output. $\overline{\text{RESET}}$ goes low when an input drops below the specified threshold (or above in the case of the -0.5 V and -5.0 V input options). After all inputs rise above the threshold voltage, $\overline{\text{RESET}}$ remains low for 200 ms (typical) before going high. $\overline{\text{RESET}}$ is open drain with a weak internal pull-up to IN ₂ , typically 10 μA . |

TYPICAL PERFORMANCE CHARACTERISTICS

$V_{IN2} = V_{CC} = 3.0\text{ V}$, $T_A = 25^\circ\text{C}$, unless otherwise noted.

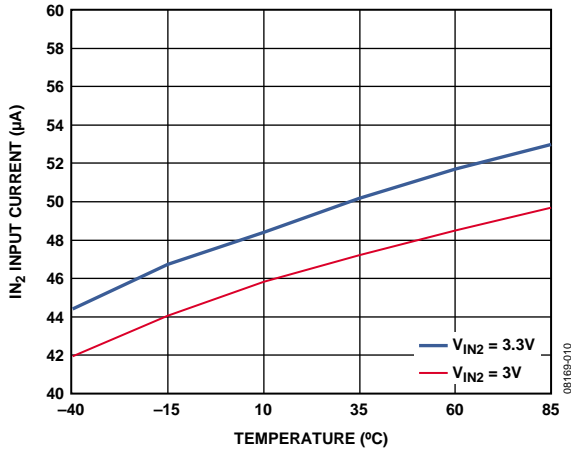

Figure 3. I_{N2} Input Current vs. Temperature

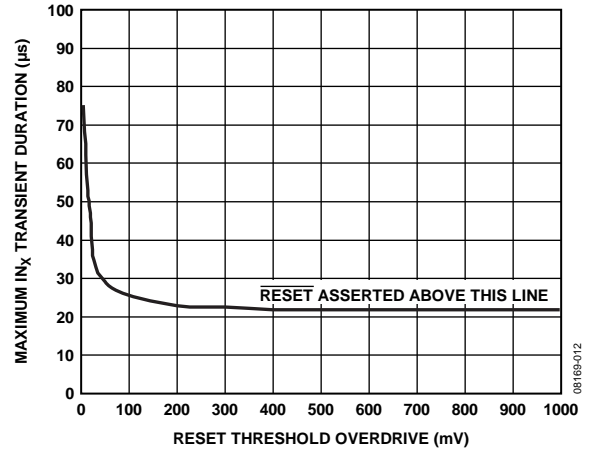

Figure 6. Maximum I_{N_x} Transient Duration vs. Reset Threshold Overdrive

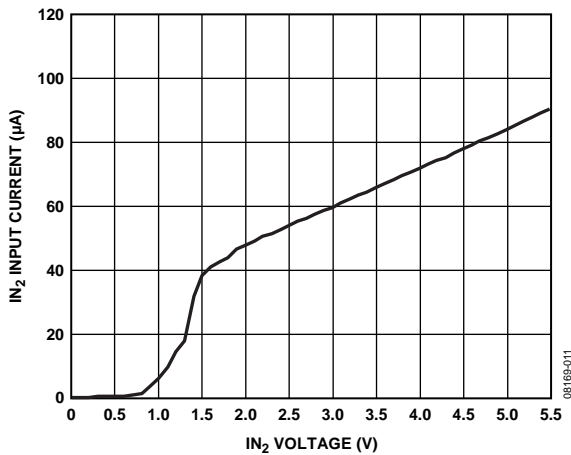

Figure 4. I_{N2} Input Current vs. I_{N2} Voltage

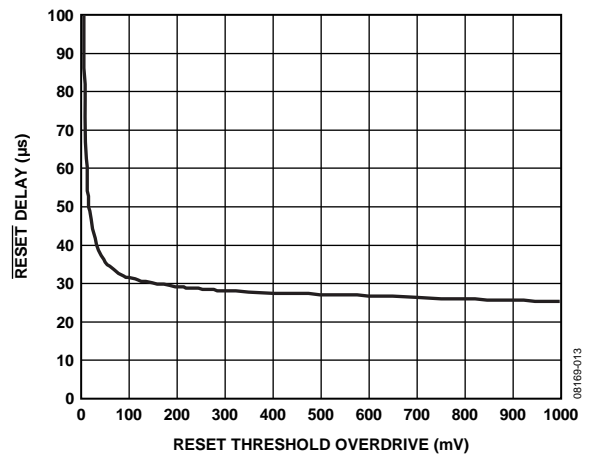

Figure 7. $\overline{\text{RESET}}$ Delay vs. Reset Threshold Overdrive (I_{N_x} Decreasing)

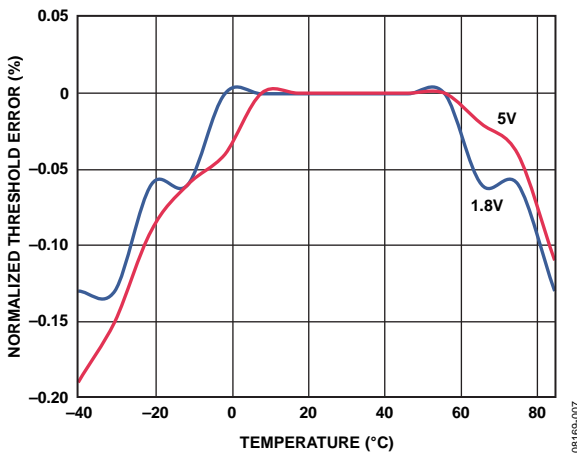

Figure 5. Normalized Threshold Error vs. Temperature

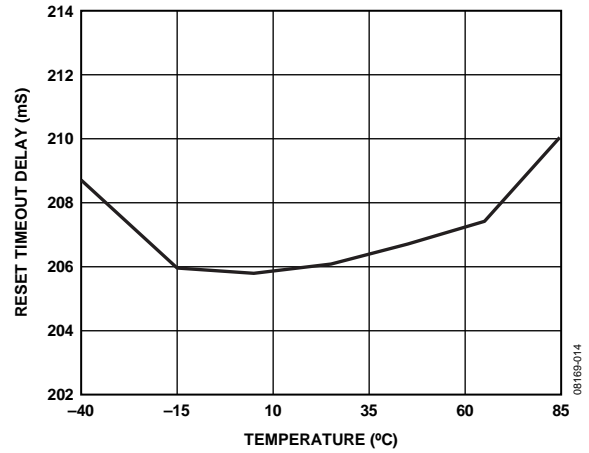

Figure 8. Reset Timeout Delay vs. Temperature

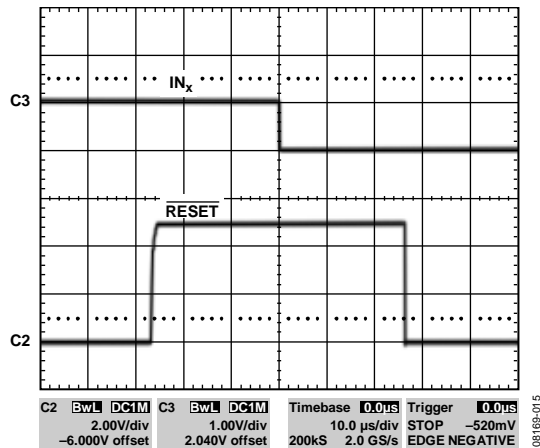

Figure 9. RESET Pull-Up and Pull-Down Response (10 μ s/Div)

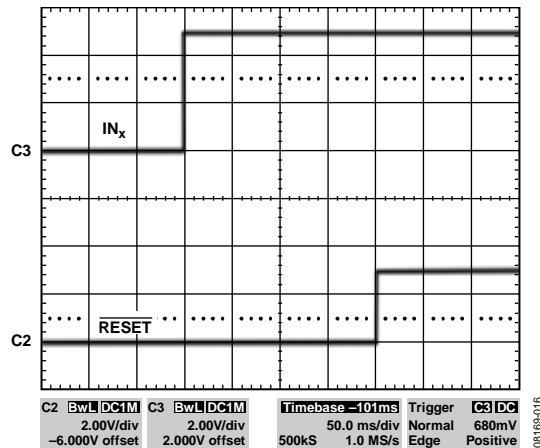

Figure 11. RESET Timeout Delay (50 ms/Div)

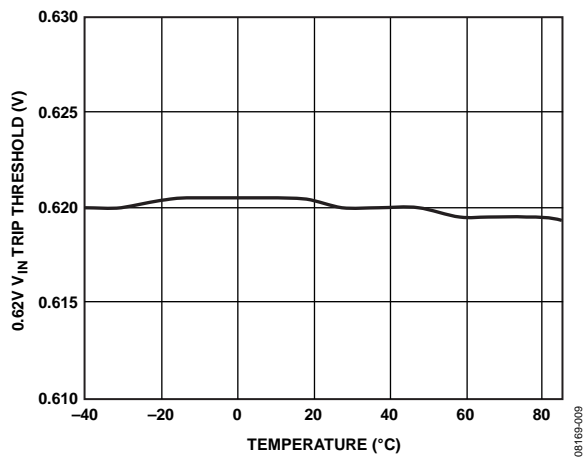

Figure 10. 0.62 V Input Voltage Trip Threshold vs. Temperature

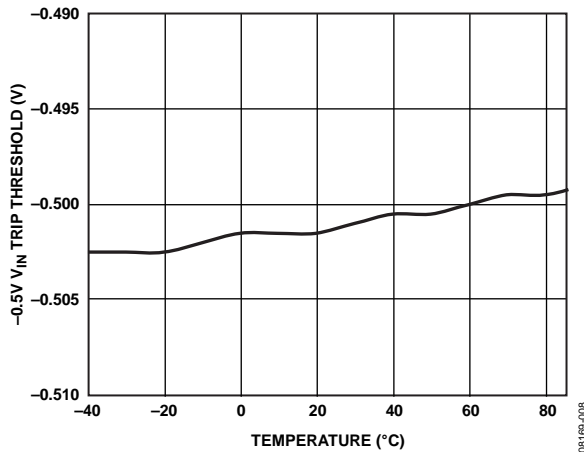

Figure 12. -0.5 V Input Voltage Trip Threshold vs. Temperature

THEORY OF OPERATION

The ADM6339 is a compact, low power supervisory circuit that is capable of monitoring up to four voltages in a multisupply application.

The device includes several factory-set voltage threshold options for monitoring -5.0 V , $+1.8\text{ V}$, $+2.5\text{ V}$, $+3.0\text{ V}$, $+3.3\text{ V}$, and $+5.0\text{ V}$ supplies. The ADM6339 is available with one to three adjustable threshold options. The adjustable voltage threshold options available are $+1.23\text{ V}$, $+0.62\text{ V}$, and -0.5 V . See the Ordering Guide section for a list and description of all available options.

INPUT CONFIGURATION

Built-in hysteresis improves the ADM6339's immunity to short input transients, without noticeably reducing the threshold accuracy. The internal comparators each have a hysteresis of 0.3% with respect to the reset threshold voltage. (The IN_4 input of the ADM6339Q model has a hysteresis of 0.47% with respect to its reset threshold voltage of -0.487 V .)

Monitored inputs are resistant to short power supply glitches. Figure 6 depicts the ADM6339 glitch immunity data. To increase noise immunity in noisy applications, place a $0.1\text{ }\mu\text{F}$ capacitor between the IN_2 input and ground. Adding capacitance to IN_1 , IN_3 , and IN_4 also improves noise immunity.

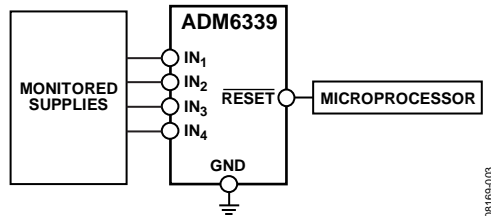

Figure 13. Typical Applications Circuit

IN_2 must always be used for normal operation because it is the device's power supply input. Do not allow unused monitor inputs to float or to be grounded. Unused IN_3 or IN_4 inputs with positive thresholds can be connected directly to the IN_2 input. Unused IN_4 options with negative thresholds must be tied to a more negative supply.

MONITORING NEGATIVE VOLTAGES $< -5.0\text{ V}$

A number of ADM6339 models include a pretrimmed threshold option to monitor -5.0 V voltage levels. Use a low impedance resistor divider network similar to that shown in Figure 14 to monitor supplies more negative than -5.0 V .

The current through the external resistor divider should be greater than the input current for the -5.0 V monitor options.

For an input monitor current error of $<1\%$, the resistor network current should be greater than or equal to 2 mA (for $\text{I}_{\text{IN}4} = 20\text{ }\mu\text{A}$ maximum). Set $R_2 = 2.5\text{ k}\Omega$. Calculate R_1 based on the desired V_{INTH} reset threshold voltage, using the following equation:

$$R_1 = R_2((V_{\text{INTH}}/V_{\text{TH}}) - 1)$$

where:

$$R_2 \leq 2.49\text{ k}\Omega.$$

V_{INTH} is the desired threshold voltage.

V_{TH} is the internal threshold voltage.

For example, when monitoring a nominal voltage of -12 V , $V_{\text{INTH}} = -11.1\text{ V}$, $V_{\text{TH}} = -4.63\text{ V}$, and $R_2 = 2.49\text{ k}\Omega$. Therefore, using the previous equation, $R_1 = 3.48\text{ k}\Omega$.

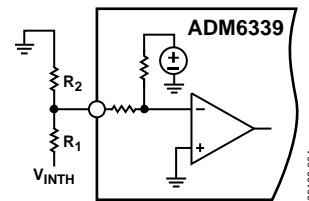

Figure 14. Negative Voltage Monitoring

USER ADJUSTABLE THRESHOLD OPTIONS

The ADM6339 offers the choice of three adjustable IN_x input threshold voltages: $+1.23\text{ V}$, $+0.62\text{ V}$, or -0.5 V .

When using an adjustable threshold of 1.23 V (typical), to monitor a voltage greater than 1.23 V , connect a resistor divider network to the device as shown in Figure 15. V_{INTH} , the desired threshold voltage, can be expressed as

$$V_{\text{INTH}} = 1.23\text{ V}((R_1 + R_2)/(R_2))$$

The ADM6339 has a guaranteed input current of $\pm 0.1\text{ }\mu\text{A}$ on its 1.23 V adjustable input. Resistor values up to $100\text{ k}\Omega$ can be used for R_2 with $<1\%$ error.

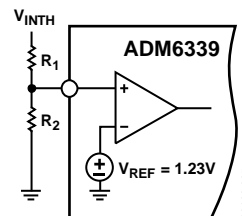

Figure 15. Setting the 1.23 V Adjustable Monitor

The same approach is taken when using the 0.62 V (typical) adjustable threshold input. Use the following equation to solve for the values of R_1 and R_2 :

$$V_{\text{INTH}} = 0.62\text{ V}((R_1 + R_2)/(R_2))$$

The 0.62 V (typical) adjustable threshold input offers high threshold accuracy of $\pm 0.8\%$.

When monitoring a voltage more negative than -0.5 V , a scheme similar to that previously described in the Monitoring Negative Voltages $< -5.0\text{ V}$ section is used. For an input monitor current error of $< 1\%$, the resistor network current should be $\geq 500\text{ }\mu\text{A}$ (for $I_{IN4} = 5\text{ }\mu\text{A}$ maximum). Calculate R_1 based on the desired V_{INTH} reset threshold voltage, using the following equation:

$$R_1 = R_2((V_{INTH}/V_{TH}) - 1)$$

where V_{INTH} is the desired threshold voltage and V_{TH} is the internal threshold voltage, -0.487 V (typical).

RESET OUTPUT CONFIGURATION

The $\overline{\text{RESET}}$ output asserts low if a monitored IN_x voltage drops below its voltage threshold (or goes above its associated threshold in the case of the -0.5 V and -5.0 V input options). After all voltages exceed their associated threshold level, the reset signal remains low for the reset timeout period, t_{RP} (200 ms typical).

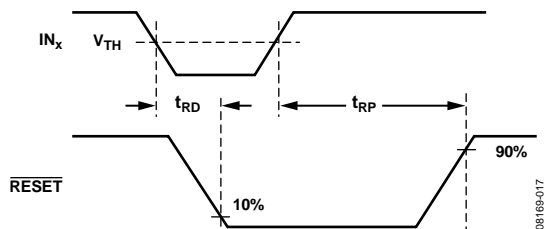

Figure 16. ADM6339 $\overline{\text{RESET}}$ Timing

$\overline{\text{RESET}}$ is open drain with a weak internal pull-up to IN_2 of $10\text{ }\mu\text{A}$ (typical). Many applications that interface with other logic devices do not require an external pull-up resistor. However, if an external pull-up resistor is required and it is connected to a voltage ranging from 0 V to 5.5 V , the resistor overdrives the internal pull-up. Reverse current flow from the external pull-up voltage to IN_2 is prevented by the internal circuitry.

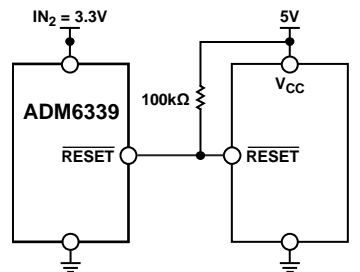
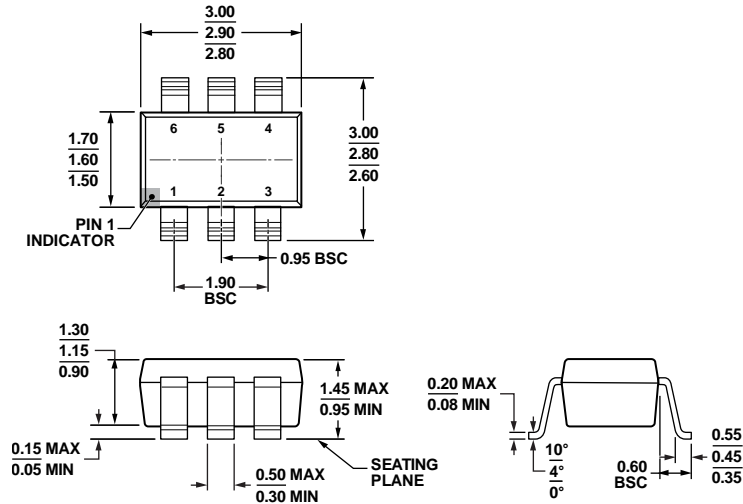

Figure 17. Interfacing with a Different Logic Supply Voltage

ADM6339

OUTLINE DIMENSIONS



COMPLIANT TO JEDEC STANDARDS MO-178-AB

Figure 18. 6-Lead Small Outline Transistor Package [SOT-23] (RJ-6)

Dimensions shown in millimeters

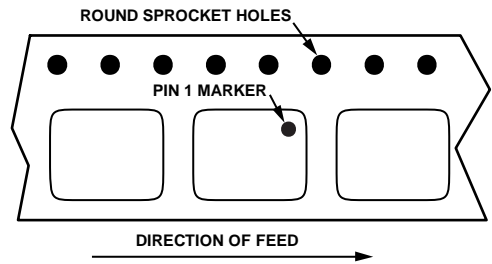

Figure 19. ADM6339 Reel Orientation

ORDERING GUIDE

| Model ^{1, 2} | Nominal Input Voltage (V) | | | | Tolerance (%) | Temperature Range | Package Description | Package Option | Branding |
|-----------------------|---------------------------|-----------------|-----------------|-----------------|---------------|-------------------|---------------------|----------------|----------|
| | IN ₁ | IN ₂ | IN ₃ | IN ₄ | | | | | |
| ADM6339AARJZ-RL7 | 5.0 | 3.3 | 2.5 | Adj (1.23) | 10 | -40°C to +85°C | 6-Lead SOT-23 | RJ-6 | MBF |
| ADM6339BARJZ-RL7 | 5.0 | 3.3 | 2.5 | Adj (1.23) | 5 | -40°C to +85°C | 6-Lead SOT-23 | RJ-6 | MBH |
| ADM6339CARJZ-RL7 | 5.0 | 3.3 | 1.8 | Adj (1.23) | 10 | -40°C to +85°C | 6-Lead SOT-23 | RJ-6 | MBJ |
| ADM6339DARJZ-RL7 | 5.0 | 3.3 | 1.8 | Adj (1.23) | 5 | -40°C to +85°C | 6-Lead SOT-23 | RJ-6 | MBK |
| ADM6339EARJZ-RL7 | 5.0 | 3.0 | 2.5 | Adj (1.23) | 10 | -40°C to +85°C | 6-Lead SOT-23 | RJ-6 | MBL |
| ADM6339FARJZ-RL7 | 5.0 | 3.0 | 2.5 | Adj (1.23) | 5 | -40°C to +85°C | 6-Lead SOT-23 | RJ-6 | MBM |
| ADM6339GARJZ-RL7 | 5.0 | 3.0 | 1.8 | Adj (1.23) | 10 | -40°C to +85°C | 6-Lead SOT-23 | RJ-6 | MBN |
| ADM6339HARJZ-RL7 | 5.0 | 3.0 | 1.8 | Adj (1.23) | 5 | -40°C to +85°C | 6-Lead SOT-23 | RJ-6 | MBP |
| ADM6339IARJZ-RL7 | 5.0 | 3.3 | 2.5 | 1.8 | 10 | -40°C to +85°C | 6-Lead SOT-23 | RJ-6 | MBQ |
| ADM6339JARJZ-RL7 | 5.0 | 3.3 | 2.5 | 1.8 | 5 | -40°C to +85°C | 6-Lead SOT-23 | RJ-6 | MBR |
| ADM6339KARJZ-RL7 | Adj (1.23) | 3.3 | 2.5 | Adj (1.23) | 10 | -40°C to +85°C | 6-Lead SOT-23 | RJ-6 | MBS |
| ADM6339LARJZ-RL7 | Adj (1.23) | 3.3 | 2.5 | Adj (1.23) | 5 | -40°C to +85°C | 6-Lead SOT-23 | RJ-6 | MBU |
| ADM6339MARJZ-RL7 | 5.0 | 3.0 | Adj (1.23) | -5.0 | 10 | -40°C to +85°C | 6-Lead SOT-23 | RJ-6 | MB6 |
| ADM6339NARJZ-RL7 | 5.0 | 3.0 | Adj (1.23) | -5.0 | 5 | -40°C to +85°C | 6-Lead SOT-23 | RJ-6 | MB7 |
| ADM6339OARJZ-RL7 | 5.0 | 3.3 | Adj (1.23) | -5.0 | 10 | -40°C to +85°C | 6-Lead SOT-23 | RJ-6 | MB8 |
| ADM6339PARJZ-RL7 | 5.0 | 3.3 | Adj (1.23) | -5.0 | 5 | -40°C to +85°C | 6-Lead SOT-23 | RJ-6 | MB5 |
| ADM6339QARJZ-RL7 | Adj (0.62) | 3.3 | Adj (0.62) | Adj (-0.5) | 10 | -40°C to +85°C | 6-Lead SOT-23 | RJ-6 | MBX |

¹ Z = RoHS Compliant Part.

² Nominal input voltage is specified with 10% tolerance.

NOTES

ADM6339

NOTES



Компания «ЭлектроПласт» предлагает заключение долгосрочных отношений при поставках импортных электронных компонентов на взаимовыгодных условиях!

Наши преимущества:

- Оперативные поставки широкого спектра электронных компонентов отечественного и импортного производства напрямую от производителей и с крупнейших мировых складов;
- Поставка более 17-ти миллионов наименований электронных компонентов;
- Поставка сложных, дефицитных, либо снятых с производства позиций;
- Оперативные сроки поставки под заказ (от 5 рабочих дней);
- Экспресс доставка в любую точку России;
- Техническая поддержка проекта, помощь в подборе аналогов, поставка прототипов;
- Система менеджмента качества сертифицирована по Международному стандарту ISO 9001;
- Лицензия ФСБ на осуществление работ с использованием сведений, составляющих государственную тайну;
- Поставка специализированных компонентов (Xilinx, Altera, Analog Devices, Intersil, Interpoint, Microsemi, Aeroflex, Peregrine, Syfer, Eurofarad, Texas Instrument, Miteq, Cobham, E2V, MA-COM, Hittite, Mini-Circuits, General Dynamics и др.);

Помимо этого, одним из направлений компании «ЭлектроПласт» является направление «Источники питания». Мы предлагаем Вам помощь Конструкторского отдела:

- Подбор оптимального решения, техническое обоснование при выборе компонента;
- Подбор аналогов;
- Консультации по применению компонента;
- Поставка образцов и прототипов;
- Техническая поддержка проекта;
- Защита от снятия компонента с производства.



Как с нами связаться

Телефон: 8 (812) 309 58 32 (многоканальный)

Факс: 8 (812) 320-02-42

Электронная почта: org@eplast1.ru

Адрес: 198099, г. Санкт-Петербург, ул. Калинина, дом 2, корпус 4, литера А.