

### FEATURES

**Accurate monitoring of up to four power supply voltages**  
**6 factory-set threshold options:  $-5.0\text{ V}$ ,  $+1.8\text{ V}$ ,  $+2.5\text{ V}$ ,  $+3.0\text{ V}$ ,  $+3.3\text{ V}$ , and  $+5.0\text{ V}$**   
**Adjustable input threshold options:  $-0.5\text{ V}$  ( $\pm 2.0\%$  accuracy),  $+0.62\text{ V}$  ( $\pm 0.8\%$  accuracy), and  $+1.23\text{ V}$**   
**200 ms typical reset timeout**  
**Open-drain  $\overline{\text{RESET}}$  output (10  $\mu\text{A}$  internal pull-up)**  
**Reset output stage: active low, valid to  $\text{IN}_1 = 1\text{ V}$  or  $\text{IN}_2 = 1\text{ V}$**   
**Low power consumption (55  $\mu\text{A}$ )**  
**Glitch immunity**  
**Specified from  $-40^\circ\text{C}$  to  $+85^\circ\text{C}$**   
**6-lead SOT-23 package**

### APPLICATIONS

**Telecommunications**  
**Microprocessor systems**  
**Data storage equipment**  
**Servers/workstations**

### GENERAL DESCRIPTION

The ADM6339 is a high accuracy supervisory circuit capable of monitoring up to four system supply voltages.

The ADM6339 incorporates a variety of internally pretrimmed undervoltage threshold options for monitoring  $-5.0\text{ V}$ ,  $+1.8\text{ V}$ ,  $+2.5\text{ V}$ ,  $+3.0\text{ V}$ ,  $+3.3\text{ V}$ , and  $+5.0\text{ V}$  supply voltages. Tolerance levels of  $\pm 5\%$  and  $\pm 10\%$  are available. The device is also available with one to three adjustable threshold options. The adjustable voltage threshold options are  $+1.23\text{ V}$ ,  $+0.62\text{ V}$ , and  $-0.5\text{ V}$ . See the Ordering Guide section for a list and description of all available options.

If a monitored power supply voltage decreases below the minimum voltage threshold (or rises above the maximum voltage threshold for the  $-0.5\text{ V}$  and  $-5.0\text{ V}$  input options), a single

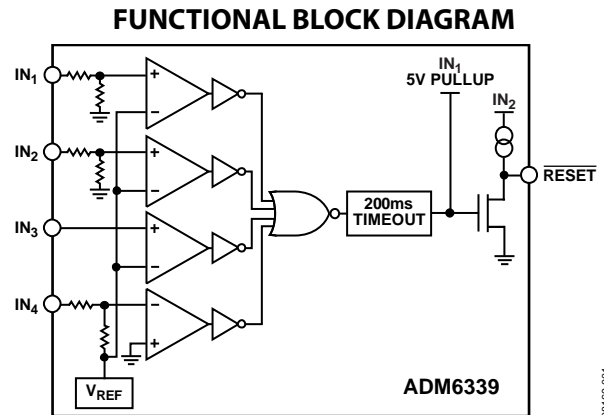

Figure 1.

active low output asserts, triggering a system reset. The output is open drain with a weak internal pull-up to the monitored  $\text{IN}_2$  supply of typically  $10\ \mu\text{A}$ . After all voltages exceed the selected threshold level, the reset signal remains low for the reset timeout period (200 ms typical).

The ADM6339 output remains valid as long as  $\text{IN}_1$  or  $\text{IN}_2$  exceeds 1 V. Unused monitored inputs should not be allowed to float or to be grounded; instead, they should be connected to a supply voltage greater than their specified threshold voltages.

The ADM6339 is available in a 6-lead SOT-23 package. The device operates over the extended temperature range of  $-40^\circ\text{C}$  to  $+85^\circ\text{C}$ .

#### Rev. A

Information furnished by Analog Devices is believed to be accurate and reliable. However, no responsibility is assumed by Analog Devices for its use, nor for any infringements of patents or other rights of third parties that may result from its use. Specifications subject to change without notice. No license is granted by implication or otherwise under any patent or patent rights of Analog Devices. Trademarks and registered trademarks are the property of their respective owners.

## TABLE OF CONTENTS

Features .....	1	Typical Performance Characteristics .....	6
Applications .....	1	Theory of Operation .....	8
Functional Block Diagram .....	1	Input Configuration .....	8
General Description .....	1	Monitoring Negative Voltages < -5.0 V .....	8
Revision History .....	2	User Adjustable Threshold Options .....	8
Specifications .....	3	RESET Output Configuration .....	9
Absolute Maximum Ratings .....	4	Outline Dimensions .....	10
ESD Caution .....	4	Ordering Guide .....	10
Pin Configuration and Function Descriptions .....	5		

## REVISION HISTORY

### 10/10—Rev. 0 to Rev. A

Added Figure 19..... 10

### 6/09—Revision 0: Initial Version

## SPECIFICATIONS

$V_{IN2} = 1.0\text{ V to }5.5\text{ V}$ ,  $T_A = -40^\circ\text{C to }+85^\circ\text{C}$ , unless otherwise noted. Typical values are  $V_{IN2} = 3.0\text{ V to }3.3\text{ V}$ ,  $T_A = 25^\circ\text{C}$ .

Table 1.

Parameter	Min	Typ	Max	Units	Test Conditions/Comments
OPERATING VOLTAGE RANGE ( $V_{IN2}$ ) <sup>1, 2</sup>	1.0		5.5	V	
INPUT CURRENT					
IN <sub>x</sub> Input Current		25	40	μA	$V_{INx}$ = nominal input voltage for 1.8 V, 2.5 V, and 5.0 V supplies.
		55	115	μA	$V_{IN2}$ = nominal input voltage for 3.0 V and 3.3 V supplies. $V_{IN2}$ is also the device power supply. The supply splits into 25 μA for the resistor divider and 30 μA for other circuits.
	-0.1		+0.1	μA	$V_{INx} = 0\text{ V to }V_{IN2}$ (input threshold voltage = 1.23 V).
		0.4	1.5	μA	$V_{IN1} = 1.5\text{ V}$ (ADM6339K and ADM6639L models only).
		-15	-20	μA	$V_{INx} = -5.0\text{ V}$ (IN <sub>x</sub> input threshold voltage = -5.0 V).
	-0.1		+0.1	μA	$V_{INx} = 0.62\text{ V}$ (IN <sub>x</sub> input threshold voltage = 0.62 V).
	-1	-3	-5	μA	$V_{INx} = -0.5\text{ V}$ (IN <sub>x</sub> input threshold voltage = -0.5 V).
THRESHOLD VOLTAGE					
Fixed Threshold Voltage ( $V_{TH}$ )	4.50	4.63	4.75	V	5.0 V (-5% tolerance) threshold.
$V_{INx}$ Decreasing	4.25	4.38	4.50	V	5.0 V (-10% tolerance) threshold.
	3.00	3.08	3.15	V	3.3 V (-5% tolerance) threshold.
	2.85	2.93	3.00	V	3.3 V (-10% tolerance) threshold.
	2.70	2.78	2.85	V	3.0 V (-5% tolerance) threshold.
	2.55	2.63	2.70	V	3.0 V (-10% tolerance) threshold.
	2.13	2.19	2.25	V	2.5 V (-10% tolerance) threshold.
	1.53	1.58	1.62	V	1.8 V (-10% tolerance) threshold.
$V_{INx}$ Increasing	-4.75	-4.63	-4.50	V	-5.0 V (+5% tolerance) threshold.
	-4.50	-4.38	-4.25	V	-5.0 V (+10% tolerance) threshold.
Adjustable Threshold Voltage ( $V_{TH}$ )					
$V_{INx}$ Decreasing	1.20	1.23	1.26	V	
	0.615	0.620	0.625	V	
$V_{INx}$ Increasing	-0.497	-0.487	-0.477	V	-0.5 V threshold.
RESET THRESHOLD HYSTERESIS ( $V_{HYST}$ )		0.3		% $V_{TH}$	
		0.47		% $V_{TH}$	IN <sub>4</sub> , ADM6339Q model.
RESET THRESHOLD TEMPERATURE COEFFICIENT ( $TCV_{TH}$ )		60		ppm/°C	
IN <sub>x</sub> to RESET DELAY ( $t_{RD}$ )		30		μs	$V_{INx} = V_{TH}$ to ( $V_{TH} - 50\text{ mV}$ ) for all inputs except -0.5 V and -5.0 V; $V_{INx} = V_{TH}$ to ( $V_{TH} + 50\text{ mV}$ ) for -5.0 V and -0.5 V inputs only.
RESET TIMEOUT PERIOD ( $t_{RP}$ )	140	200	280	ms	
RESET OUTPUT LOW ( $V_{OL}$ )			0.4	V	$V_{IN2} = 5.0\text{ V}$ , $I_{SINK} = 2\text{ mA}$ .
			0.4	V	$V_{IN2} = 2.5\text{ V}$ , $I_{SINK} = 1.2\text{ mA}$ .
			0.4	V	$V_{IN2} = V_{IN1} = 1\text{ V}$ , $I_{SINK} = 50\text{ μA}$ .
			0.4	V	$V_{IN1} = 1\text{ V}$ , $V_{IN2} = 0\text{ V}$ , $I_{SINK} = 20\text{ μA}$
			0.4	V	$V_{IN1} = 0\text{ V}$ , $V_{IN2} = 1\text{ V}$ , $I_{SINK} = 20\text{ μA}$
RESET OUTPUT HIGH ( $V_{OH}$ )	$0.8 \times V_{IN2}$			V	$V_{IN2} \geq 2.55\text{ V}$ , $I_{SOURCE} = 6\text{ μA}$ , RESET not asserted.
RESET OUTPUT HIGH SOURCE CURRENT ( $I_{OH}$ )		10		μA	$V_{IN2} \geq 2.55\text{ V}$ , RESET not asserted.

<sup>1</sup> The device is powered by Input IN<sub>2</sub>.

<sup>2</sup> The RESET output is guaranteed to be in the correct state for IN<sub>1</sub> or IN<sub>2</sub> down to 1 V.

# ADM6339

## ABSOLUTE MAXIMUM RATINGS

Table 2.

Parameter	Rating
$V_{CC}$ , $\overline{RESET}$ , GND	-0.3 V to +6 V
Continuous $\overline{RESET}$ Current	20 mA
$IN_x$ (Positive Reset Threshold)	-0.3 V to +6 V
$IN_4$ (Negative Reset Threshold, -5 V)	-6 V to +0.3 V
$IN_4$ ADM6339Q Model (Negative Reset Threshold, -0.5 V)	-2 V to +0.3 V
Storage Temperature Range	-65°C to +125°C
Operating Temperature Range	-40°C to +85°C
Lead Temperature (10 sec)	300°C
Junction Temperature	135°C

Stresses above those listed under Absolute Maximum Ratings may cause permanent damage to the device. This is a stress rating only; functional operation of the device at these or any other conditions above those indicated in the operational section of this specification is not implied. Exposure to absolute maximum rating conditions for extended periods may affect device reliability.

Table 3. Thermal Resistance

Package Type	$\theta_{JA}$	Unit
6-Lead SOT-23	169.5	°C/W

### ESD CAUTION



**ESD (electrostatic discharge) sensitive device.** Charged devices and circuit boards can discharge without detection. Although this product features patented or proprietary protection circuitry, damage may occur on devices subjected to high energy ESD. Therefore, proper ESD precautions should be taken to avoid performance degradation or loss of functionality.

## PIN CONFIGURATION AND FUNCTION DESCRIPTIONS

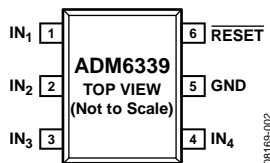

Figure 2. Pin Configuration

Table 4. Pin Function Descriptions

Pin No.	Mnemonic	Description
1	IN <sub>1</sub>	Monitored Input Voltage 1.
2	IN <sub>2</sub>	Monitored Input Voltage 2. IN <sub>2</sub> is the power supply input for the ADM6339.
3	IN <sub>3</sub>	Monitored Input Voltage 3.
4	IN <sub>4</sub>	Monitored Input Voltage 4.
5	GND	Ground.
6	$\overline{\text{RESET}}$	Active Low $\overline{\text{RESET}}$ Output. $\overline{\text{RESET}}$ goes low when an input drops below the specified threshold (or above in the case of the $-0.5\text{ V}$ and $-5.0\text{ V}$ input options). After all inputs rise above the threshold voltage, $\overline{\text{RESET}}$ remains low for 200 ms (typical) before going high. $\overline{\text{RESET}}$ is open drain with a weak internal pull-up to IN <sub>2</sub> , typically 10 $\mu\text{A}$ .

## TYPICAL PERFORMANCE CHARACTERISTICS

$V_{IN2} = V_{CC} = 3.0\text{ V}$ ,  $T_A = 25^\circ\text{C}$ , unless otherwise noted.

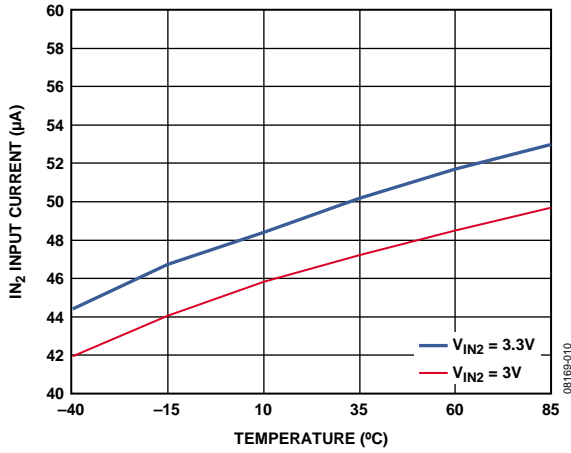

Figure 3. IN<sub>2</sub> Input Current vs. Temperature

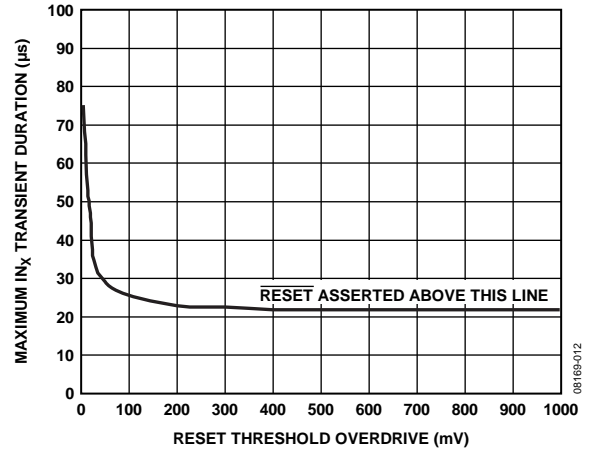

Figure 6. Maximum IN<sub>x</sub> Transient Duration vs. Reset Threshold Overdrive

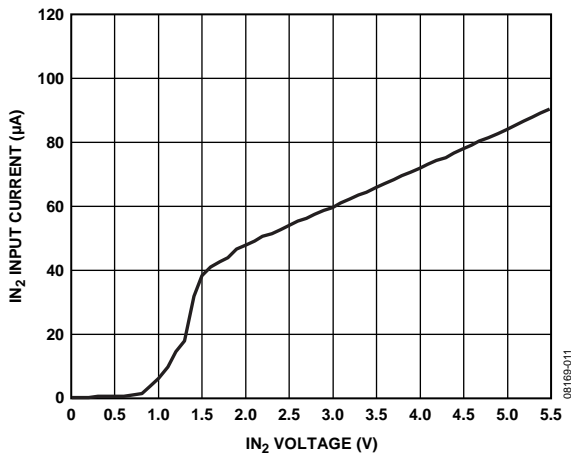

Figure 4. IN<sub>2</sub> Input Current vs. IN<sub>2</sub> Voltage

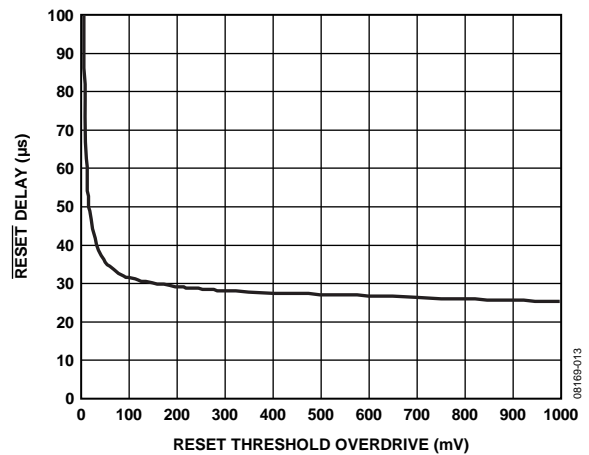

Figure 7. RESET Delay vs. Reset Threshold Overdrive (IN<sub>x</sub> Decreasing)

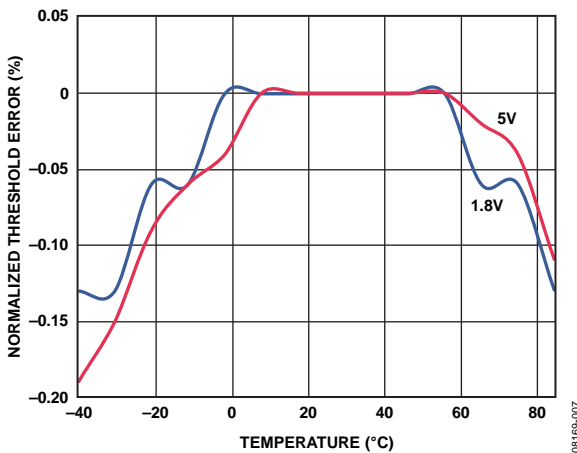

Figure 5. Normalized Threshold Error vs. Temperature

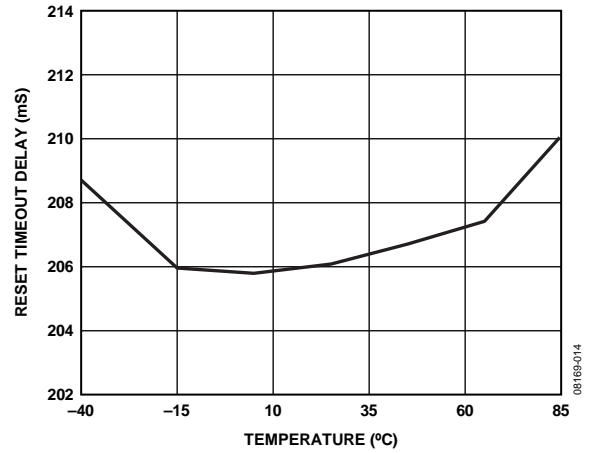

Figure 8. Reset Timeout Delay vs. Temperature

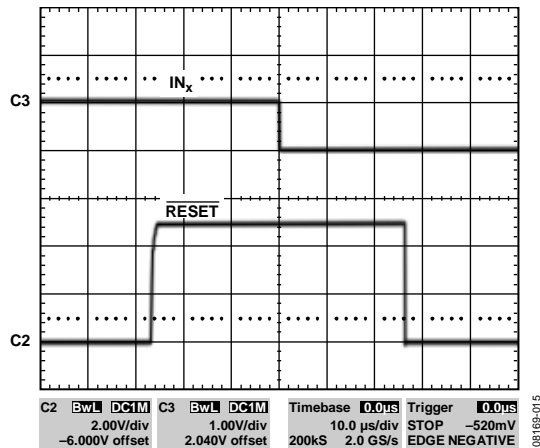

Figure 9. RESET Pull-Up and Pull-Down Response (10  $\mu$ s/Div)

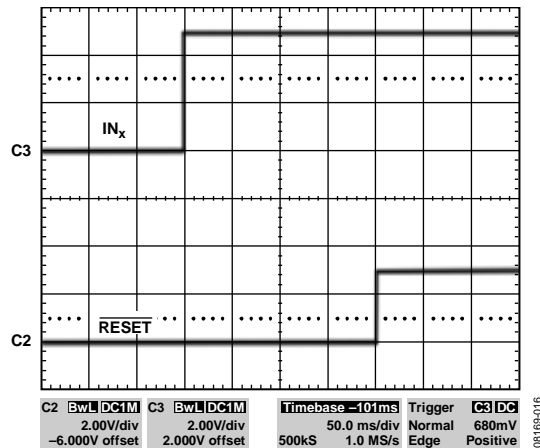

Figure 11. RESET Timeout Delay (50 ms/Div)

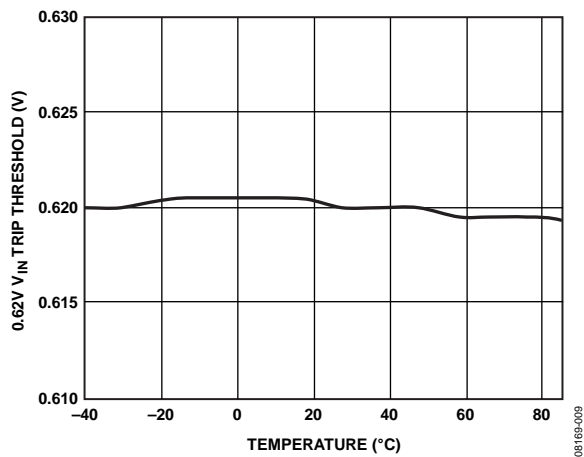

Figure 10. 0.62 V Input Voltage Trip Threshold vs. Temperature

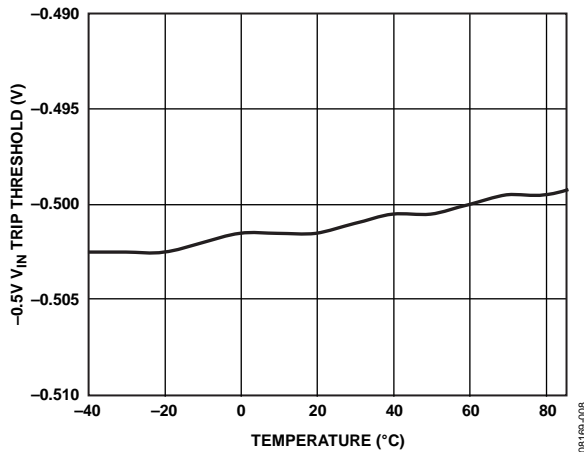

Figure 12. -0.5 V Input Voltage Trip Threshold vs. Temperature

## THEORY OF OPERATION

The ADM6339 is a compact, low power supervisory circuit that is capable of monitoring up to four voltages in a multisupply application.

The device includes several factory-set voltage threshold options for monitoring  $-5.0\text{ V}$ ,  $+1.8\text{ V}$ ,  $+2.5\text{ V}$ ,  $+3.0\text{ V}$ ,  $+3.3\text{ V}$ , and  $+5.0\text{ V}$  supplies. The ADM6339 is available with one to three adjustable threshold options. The adjustable voltage threshold options available are  $+1.23\text{ V}$ ,  $+0.62\text{ V}$ , and  $-0.5\text{ V}$ . See the Ordering Guide section for a list and description of all available options.

## INPUT CONFIGURATION

Built-in hysteresis improves the ADM6339's immunity to short input transients, without noticeably reducing the threshold accuracy. The internal comparators each have a hysteresis of 0.3% with respect to the reset threshold voltage. (The  $\text{IN}_4$  input of the ADM6339Q model has a hysteresis of 0.47% with respect to its reset threshold voltage of  $-0.487\text{ V}$ .)

Monitored inputs are resistant to short power supply glitches. Figure 6 depicts the ADM6339 glitch immunity data. To increase noise immunity in noisy applications, place a  $0.1\text{ }\mu\text{F}$  capacitor between the  $\text{IN}_2$  input and ground. Adding capacitance to  $\text{IN}_1$ ,  $\text{IN}_3$ , and  $\text{IN}_4$  also improves noise immunity.

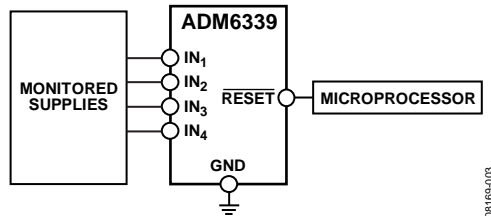

Figure 13. Typical Applications Circuit

$\text{IN}_2$  must always be used for normal operation because it is the device's power supply input. Do not allow unused monitor inputs to float or to be grounded. Unused  $\text{IN}_3$  or  $\text{IN}_4$  inputs with positive thresholds can be connected directly to the  $\text{IN}_2$  input. Unused  $\text{IN}_4$  options with negative thresholds must be tied to a more negative supply.

## MONITORING NEGATIVE VOLTAGES $< -5.0\text{ V}$

A number of ADM6339 models include a pretrimmed threshold option to monitor  $-5.0\text{ V}$  voltage levels. Use a low impedance resistor divider network similar to that shown in Figure 14 to monitor supplies more negative than  $-5.0\text{ V}$ .

The current through the external resistor divider should be greater than the input current for the  $-5.0\text{ V}$  monitor options.

For an input monitor current error of  $<1\%$ , the resistor network current should be greater than or equal to  $2\text{ mA}$  (for  $\text{I}_{\text{IN}4} = 20\text{ }\mu\text{A}$  maximum). Set  $R_2 = 2.5\text{ k}\Omega$ . Calculate  $R_1$  based on the desired  $V_{\text{INTH}}$  reset threshold voltage, using the following equation:

$$R_1 = R_2((V_{\text{INTH}}/V_{\text{TH}}) - 1)$$

where:

$$R_2 \leq 2.49\text{ k}\Omega.$$

$V_{\text{INTH}}$  is the desired threshold voltage.

$V_{\text{TH}}$  is the internal threshold voltage.

For example, when monitoring a nominal voltage of  $-12\text{ V}$ ,  $V_{\text{INTH}} = -11.1\text{ V}$ ,  $V_{\text{TH}} = -4.63\text{ V}$ , and  $R_2 = 2.49\text{ k}\Omega$ . Therefore, using the previous equation,  $R_1 = 3.48\text{ k}\Omega$ .

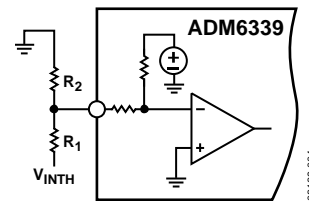

Figure 14. Negative Voltage Monitoring

## USER ADJUSTABLE THRESHOLD OPTIONS

The ADM6339 offers the choice of three adjustable  $\text{IN}_x$  input threshold voltages:  $+1.23\text{ V}$ ,  $+0.62\text{ V}$ , or  $-0.5\text{ V}$ .

When using an adjustable threshold of  $1.23\text{ V}$  (typical), to monitor a voltage greater than  $1.23\text{ V}$ , connect a resistor divider network to the device as shown in Figure 15.  $V_{\text{INTH}}$ , the desired threshold voltage, can be expressed as

$$V_{\text{INTH}} = 1.23\text{ V}((R_1 + R_2)/(R_2))$$

The ADM6339 has a guaranteed input current of  $\pm 0.1\text{ }\mu\text{A}$  on its  $1.23\text{ V}$  adjustable input. Resistor values up to  $100\text{ k}\Omega$  can be used for  $R_2$  with  $<1\%$  error.

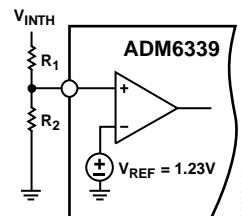

Figure 15. Setting the  $1.23\text{ V}$  Adjustable Monitor

The same approach is taken when using the  $0.62\text{ V}$  (typical) adjustable threshold input. Use the following equation to solve for the values of  $R_1$  and  $R_2$ :

$$V_{\text{INTH}} = 0.62\text{ V}((R_1 + R_2)/(R_2))$$

The  $0.62\text{ V}$  (typical) adjustable threshold input offers high threshold accuracy of  $\pm 0.8\%$ .



When monitoring a voltage more negative than  $-0.5\text{ V}$ , a scheme similar to that previously described in the Monitoring Negative Voltages  $< -5.0\text{ V}$  section is used. For an input monitor current error of  $< 1\%$ , the resistor network current should be  $\geq 500\text{ }\mu\text{A}$  (for  $I_{IN4} = 5\text{ }\mu\text{A}$  maximum). Calculate  $R_1$  based on the desired  $V_{INTH}$  reset threshold voltage, using the following equation:

$$R_1 = R_2((V_{INTH}/V_{TH}) - 1)$$

where  $V_{INTH}$  is the desired threshold voltage and  $V_{TH}$  is the internal threshold voltage,  $-0.487\text{ V}$  (typical).

### RESET OUTPUT CONFIGURATION

The  $\overline{\text{RESET}}$  output asserts low if a monitored  $\text{IN}_x$  voltage drops below its voltage threshold (or goes above its associated threshold in the case of the  $-0.5\text{ V}$  and  $-5.0\text{ V}$  input options). After all voltages exceed their associated threshold level, the reset signal remains low for the reset timeout period,  $t_{RP}$  (200 ms typical).

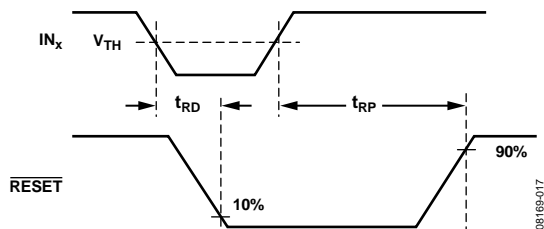

Figure 16. ADM6339  $\overline{\text{RESET}}$  Timing

$\overline{\text{RESET}}$  is open drain with a weak internal pull-up to  $\text{IN}_2$  of  $10\text{ }\mu\text{A}$  (typical). Many applications that interface with other logic devices do not require an external pull-up resistor. However, if an external pull-up resistor is required and it is connected to a voltage ranging from  $0\text{ V}$  to  $5.5\text{ V}$ , the resistor overdrives the internal pull-up. Reverse current flow from the external pull-up voltage to  $\text{IN}_2$  is prevented by the internal circuitry.

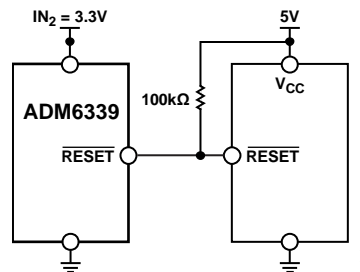
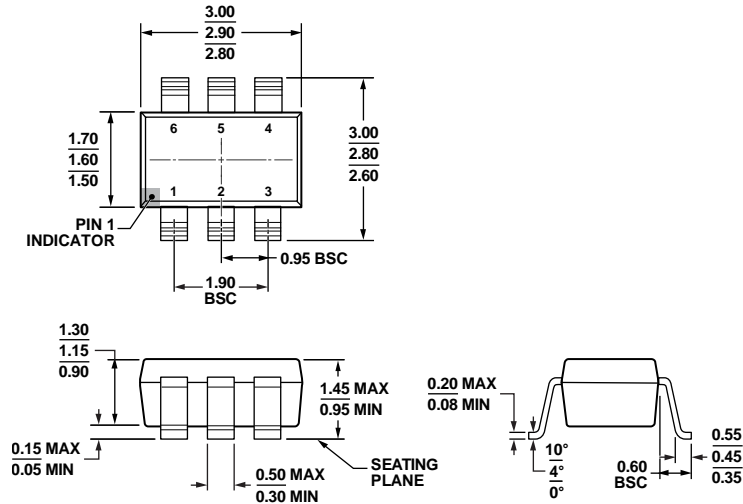

Figure 17. Interfacing with a Different Logic Supply Voltage

# ADM6339

## OUTLINE DIMENSIONS



COMPLIANT TO JEDEC STANDARDS MO-178-AB

Figure 18. 6-Lead Small Outline Transistor Package [SOT-23] (RJ-6)

Dimensions shown in millimeters

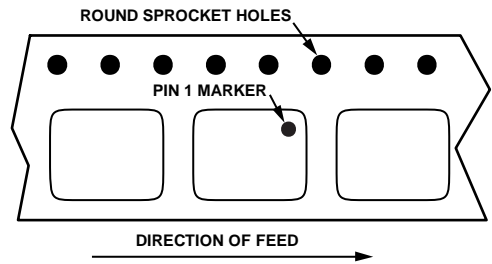

Figure 19. ADM6339 Reel Orientation

## ORDERING GUIDE

Model <sup>1, 2</sup>	Nominal Input Voltage (V)				Tolerance (%)	Temperature Range	Package Description	Package Option	Branding
	IN <sub>1</sub>	IN <sub>2</sub>	IN <sub>3</sub>	IN <sub>4</sub>					
ADM6339AARJZ-RL7	5.0	3.3	2.5	Adj (1.23)	10	-40°C to +85°C	6-Lead SOT-23	RJ-6	MBF
ADM6339BARJZ-RL7	5.0	3.3	2.5	Adj (1.23)	5	-40°C to +85°C	6-Lead SOT-23	RJ-6	MBH
ADM6339CARJZ-RL7	5.0	3.3	1.8	Adj (1.23)	10	-40°C to +85°C	6-Lead SOT-23	RJ-6	MBJ
ADM6339DARJZ-RL7	5.0	3.3	1.8	Adj (1.23)	5	-40°C to +85°C	6-Lead SOT-23	RJ-6	MBK
ADM6339EARJZ-RL7	5.0	3.0	2.5	Adj (1.23)	10	-40°C to +85°C	6-Lead SOT-23	RJ-6	MBL
ADM6339FARJZ-RL7	5.0	3.0	2.5	Adj (1.23)	5	-40°C to +85°C	6-Lead SOT-23	RJ-6	MBM
ADM6339GARJZ-RL7	5.0	3.0	1.8	Adj (1.23)	10	-40°C to +85°C	6-Lead SOT-23	RJ-6	MBN
ADM6339HARJZ-RL7	5.0	3.0	1.8	Adj (1.23)	5	-40°C to +85°C	6-Lead SOT-23	RJ-6	MBP
ADM6339IARJZ-RL7	5.0	3.3	2.5	1.8	10	-40°C to +85°C	6-Lead SOT-23	RJ-6	MBQ
ADM6339JARJZ-RL7	5.0	3.3	2.5	1.8	5	-40°C to +85°C	6-Lead SOT-23	RJ-6	MBR
ADM6339KARJZ-RL7	Adj (1.23)	3.3	2.5	Adj (1.23)	10	-40°C to +85°C	6-Lead SOT-23	RJ-6	MBS
ADM6339LARJZ-RL7	Adj (1.23)	3.3	2.5	Adj (1.23)	5	-40°C to +85°C	6-Lead SOT-23	RJ-6	MBU
ADM6339MARJZ-RL7	5.0	3.0	Adj (1.23)	-5.0	10	-40°C to +85°C	6-Lead SOT-23	RJ-6	MB6
ADM6339NARJZ-RL7	5.0	3.0	Adj (1.23)	-5.0	5	-40°C to +85°C	6-Lead SOT-23	RJ-6	MB7
ADM6339OARJZ-RL7	5.0	3.3	Adj (1.23)	-5.0	10	-40°C to +85°C	6-Lead SOT-23	RJ-6	MB8
ADM6339PARJZ-RL7	5.0	3.3	Adj (1.23)	-5.0	5	-40°C to +85°C	6-Lead SOT-23	RJ-6	MB5
ADM6339QARJZ-RL7	Adj (0.62)	3.3	Adj (0.62)	Adj (-0.5)	10	-40°C to +85°C	6-Lead SOT-23	RJ-6	MBX

<sup>1</sup> Z = RoHS Compliant Part.

<sup>2</sup> Nominal input voltage is specified with 10% tolerance.

**NOTES**

**ADM6339**

**NOTES**



Компания «ЭлектроПласт» предлагает заключение долгосрочных отношений при поставках импортных электронных компонентов на взаимовыгодных условиях!

Наши преимущества:

- Оперативные поставки широкого спектра электронных компонентов отечественного и импортного производства напрямую от производителей и с крупнейших мировых складов;
- Поставка более 17-ти миллионов наименований электронных компонентов;
- Поставка сложных, дефицитных, либо снятых с производства позиций;
- Оперативные сроки поставки под заказ (от 5 рабочих дней);
- Экспресс доставка в любую точку России;
- Техническая поддержка проекта, помощь в подборе аналогов, поставка прототипов;
- Система менеджмента качества сертифицирована по Международному стандарту ISO 9001;
- Лицензия ФСБ на осуществление работ с использованием сведений, составляющих государственную тайну;
- Поставка специализированных компонентов (Xilinx, Altera, Analog Devices, Intersil, Interpoint, Microsemi, Aeroflex, Peregrine, Syfer, Eurofarad, Texas Instrument, Miteq, Cobham, E2V, MA-COM, Hittite, Mini-Circuits, General Dynamics и др.);

Помимо этого, одним из направлений компании «ЭлектроПласт» является направление «Источники питания». Мы предлагаем Вам помощь Конструкторского отдела:

- Подбор оптимального решения, техническое обоснование при выборе компонента;
- Подбор аналогов;
- Консультации по применению компонента;
- Поставка образцов и прототипов;
- Техническая поддержка проекта;
- Защита от снятия компонента с производства.



#### Как с нами связаться

**Телефон:** 8 (812) 309 58 32 (многоканальный)

**Факс:** 8 (812) 320-02-42

**Электронная почта:** [org@eplast1.ru](mailto:org@eplast1.ru)

**Адрес:** 198099, г. Санкт-Петербург, ул. Калинина, дом 2, корпус 4, литера А.